

5-146281-2 ✓ ACTIVE

AMPMODU | AMPMODU Headers

TE Internal #: 5-146281-2

PCB Mount Header, Vertical, Board-to-Board, 2 Position, 2.54 mm [.1 in] Centerline, Breakaway, Gold, Through Hole - Solder, Signal, AMPMODU Headers

[View on TE.com >](#)



Connectors > PCB Connectors > PCB Headers & Receptacles

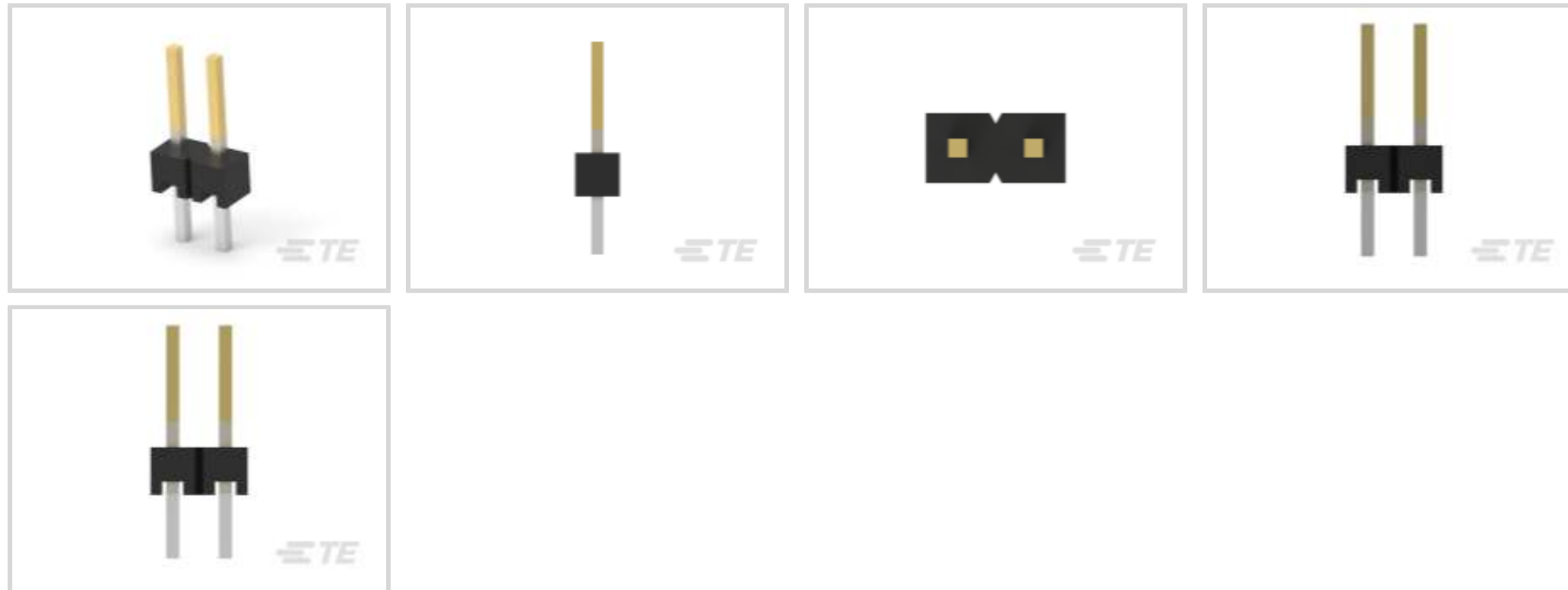

PCB Connector Assembly Type: **PCB Mount Header**

PCB Mount Orientation: **Vertical**

Connector System: **Board-to-Board**

Number of Positions: **2**

Number of Rows: **1**

Features

Product Type Features

PCB Connector Assembly Type	PCB Mount Header
Connector System	Board-to-Board
Header Type	Breakaway
Sealable	No
Connector & Contact Terminates To	Printed Circuit Board

Configuration Features

Connector Contact Load Condition	Fully Loaded
PCB Mount Orientation	Vertical
Number of Positions	2
Number of Rows	1
Board-to-Board Configuration	Parallel

Body Features

Primary Product Color	Black
-----------------------	-------

Contact Features



Mating Square Post Dimension	.64 mm[.025 in]
	100 – 200 µin
PCB Contact Termination Area Plating Material Finish	Matte
Contact Shape & Form	Square
Contact Underplating Material	Nickel
PCB Contact Termination Area Plating Material	Tin-Lead
Contact Base Material	Copper Alloy
Contact Mating Area Plating Material	Gold
Contact Mating Area Plating Material Thickness	.762 µm[30 µin]
Contact Type	Pin
Contact Current Rating (Max)	3 A

Termination Features

Square Termination Post & Tail Dimension	.64 mm[.025 in]
Termination Post & Tail Length	3.05 mm[.12 in]
Termination Method to Printed Circuit Board	Through Hole - Solder

Mechanical Attachment

Mating Alignment	Without
PCB Mount Retention	Without
PCB Mount Alignment	Without
Connector Mounting Type	Board Mount

Housing Features

Centerline (Pitch)	2.54 mm[.1 in]
Housing Material	LCP (Liquid Crystal Polymer), LCP-GF (Liquid Crystal Polymer)

Dimensions

PCB Thickness (Recommended)	1.6 mm[.063 in]
-----------------------------	-----------------

Usage Conditions

Housing Temperature Rating	High
Operating Temperature Range	-65 – 105 °C[-85 – 221 °F]

Operation/Application

Circuit Application	Signal
---------------------	--------

Industry Standards



Approved Standards	CSA LR7189, UL E28476
UL Flammability Rating	UL 94V-0

Packaging Features

Packaging Quantity	500
Packaging Type	Carton

Product Compliance

[For compliance documentation, visit the product page on TE.com>](#)

EU RoHS Directive 2011/65/EU	Compliant
EU ELV Directive 2000/53/EC	Compliant
China RoHS 2 Directive MIIT Order No 32, 2016	No Restricted Materials Above Threshold
EU REACH Regulation (EC) No. 1907/2006	Current ECHA Candidate List: JUNE 2023 (235) Candidate List Declared Against: JUNE 2023 (235) Does not contain REACH SVHC
Halogen Content	Low Bromine/Chlorine - Br and Cl < 900 ppm per homogenous material. Also BFR /CFR/PVC Free
Solder Process Capability	Pin-in-Paste capable to 260°C

Product Compliance Disclaimer

This information is provided based on reasonable inquiry of our suppliers and represents our current actual knowledge based on the information they provided. This information is subject to change. The part numbers that TE has identified as EU RoHS compliant have a maximum concentration of 0.1% by weight in homogenous materials for lead, hexavalent chromium, mercury, PBB, PBDE, DBP, BBP, DEHP, DIBP, and 0.01% for cadmium, or qualify for an exemption to these limits as defined in the Annexes of Directive 2011/65/EU (RoHS2). Finished electrical and electronic equipment products will be CE marked as required by Directive 2011/65/EU. Components may not be CE marked. Additionally, the part numbers that TE has identified as EU ELV compliant have a maximum concentration of 0.1% by weight in homogenous materials for lead, hexavalent chromium, and mercury, and 0.01% for cadmium, or qualify for an exemption to these limits as defined in the Annexes of Directive 2000/53/EC (ELV). Regarding the REACH Regulation, the information TE provides on SVHC in articles for this part number is based on the latest European Chemicals Agency (ECHA) 'Guidance on requirements for substances in articles' posted at this URL: <https://echa.europa.eu/guidance-documents/guidance-on-reach>

Compatible Parts



TE Part # 530153-2
TDM SPRING SHUNT ASSY 2 POS



TE Part # 2-881545-2
AMP SHUNT LOW PROFI



TE Part # 881545-5
AMP SHUNT ASS'Y



TE Part # 881545-2
SHUNT LP W/HANDLE 2 POS 30AU



TE Part # 390088-3
BLUE HSG WITH 30AU CONTACT



TE Part # 390088-5
YELLOW HSG WITH 30AU CONTACT

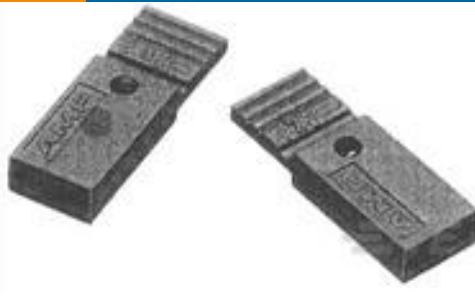

TE Part # 880584-2
SHUNT CONNECTOR



TE Part # 390088-1
BLACK HSG WITH 30AU CONTACT



TE Part # 2-382811-0
ECONOMY SHUNT, 30 AU BLACK



TE Part # 1-881545-2
AMP SHUNT ASS'Y



TE Part # 1-880584-2
SHUNT CONN. ASS'Y



TE Part # 5147721-1
02 MODII HORZ SR SFMNT 30AU



TE Part # 880584-7
AMP SHUNT CONNECTOR ASSY



TE Part # 881545-3
SHUNT LP W/HANDLE 2 POS 50AU



TE Part # 966657-4
4P HV100 REC. CON, SMD, GOLD, TUBE PACK

Also in the Series | **AMPMODU Headers**



PCB Connector Mounting(1)



PCB Connector Shrouds(1)



PCB Headers & Receptacles(4875)



PCB Latches, Locks & Retainers(1)



Wire-to-Board Connector Assemblies & Housings(5)



Wire-to-Board Connector Contacts(65)

Customers Also Bought

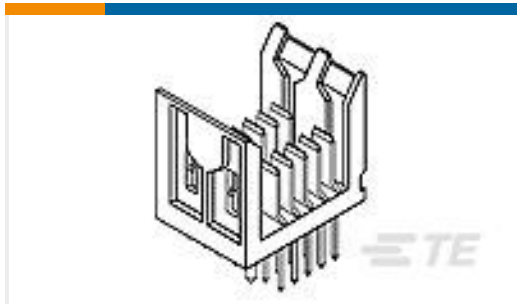
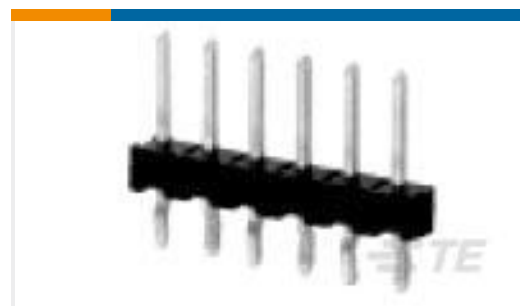
TE Part #5536642-1
FB-5R,ASY,010,PWR,HDR,EN,4.25TE Part #5650458-5
ASSEMBLY,RECEPTACLE,EURO,TYPETE Part #5-146281-8
08 MODII HDR SRST B/A .100CLTE Part #1-1600961-8
CONT 12-16 AWG PWR, STD PLATETE Part #5-146257-4
08 MODII HDR DRST B/A .100CL LTE Part #5-146261-4
08 MODII HDR DRST B/A .100CL LFTE Part #5650459-5
ASSEMBLY,RECEPTACLE,EURO,TYPETE Part #6469287-1
HM-ZD 4PR HDR 96P, 5.3TE Part #5535655-1
68 MEM CARD HDR RSD T/H TOP

Documents

CAD Files

[3D PDF](#)

[3D](#)

Customer View Model

[ENG_CVM_CVM_5-146281-2_D.2d_dxf.zip](#)

English

Customer View Model

[ENG_CVM_CVM_5-146281-2_D.3d_igs.zip](#)



English

Customer View Model

[ENG_CVM_CVM_5-146281-2_D.3d_stp.zip](#)

English

By downloading the CAD file I accept and agree to the [Terms and Conditions](#) of use.

Product Specifications

[Application Specification](#)

English

Product Environmental Compliance

[Product Compliance Document](#)

English

[Product Compliance Document](#)

English