

SF2176E

433.92 MHz
SAW Filter

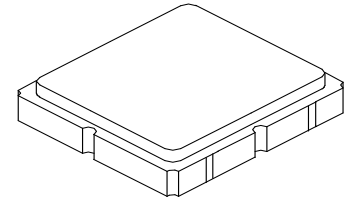

SM3030-6

- *Low-loss RF SAW Filter*
- *Surface-mount 3.0 x 3.0 x 1.3 mm Package*
- *Complies with Directive 2002/95/EC (RoHS)*
- *AEC-Q200 Qualified*
- *Moisture Sensitivity Level: 1*

Absolute Maximum Ratings

Rating	Value	Units
Input Power Level	10	dBm
DC Voltage on any Non-ground Terminal	3	V
Operating Temperature Range	-40 to +105	°C
Storage Temperature Range in Tape and Reel	-40 to +85	°C
Usable Temperature Range	-40 to 125	°C
Solder Reflow Temperature, 10 seconds, 5 cycles maximum	260	°C

Electrical Characteristics -40 to +85°C

Characteristic	Sym	Notes	Min	Typ	Max	Units
Center Frequency	F_C			433.92		MHz
Maximum Insertion Loss, 433.12 to 434.72 MHz	IL_{MAX}			2.2	2.9	dB
Amplitude Ripple, 433.12 to 434.72 MHz				0.4	1.0	dB _{P-P}
VSWR, 433.12 to 434.72 MHz				1.6	2.0	
Attenuation Referenced to 0 dB:						
10.00 to 380.00 MHz			58	61		dB
380.00 to 423.42MHz			46	50		
443.42 to 453.42 MHz			25	30		
453.42 to 460.00 MHz			35	40		
460.00 to 700.00 MHz			50	54		
700.00 to 1000.00 MHz			42	46		
Source Impedance	Z_S			50		Ω
Load Impedance	Z_L			50		
Case Style	SM3030-6 3.0 x 3.0 mm Nominal Footprint					
Lid Symbolization (Y=year, WW=week, S=shift) dot=pin 1 indicator	A09, <u>YWWS</u>					



CAUTION: Electrostatic Sensitive Device. Observe precautions for handling.

NOTES:

1. The design, manufacturing process, and specifications of this device are subject to change.
2. US or International patents may apply.
3. RoHS compliant from the first date of manufacture.

Electrical Characteristics -40 to +105°C

Characteristic	Sym	Notes	Min	Typ	Max	Units
Center Frequency	F_C			433.92		MHz
Maximum Insertion Loss, 433.12 to 434.72 MHz	IL_{MAX}			2.2	3.2	dB
Amplitude Ripple, 433.12 to 434.72 MHz				0.4	1.4	dB _{P-P}
VSWR, S11 S22				1.6	2.0	
Attenuation Referenced to 0 dB:						
10.00 to 380.00 MHz			58	61		dB
380.00 to 423.42MHz			46	50		
443.42 to 453.42 MHz			12	30		
453.42 to 460.00 MHz			35	40		
460.00 to 700.00 MHz			50	54		
700.00 to 1000.00 MHz			42	46		
Source Impedance	Z_S			50		Ω
Load Impedance	Z_L			50		

Filter Test Circuit

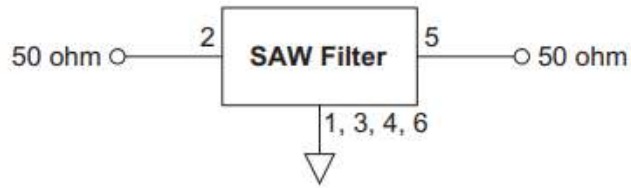

Connection	Terminals
Input	2
Output	5
Ground	All Others

Filter Response Plots

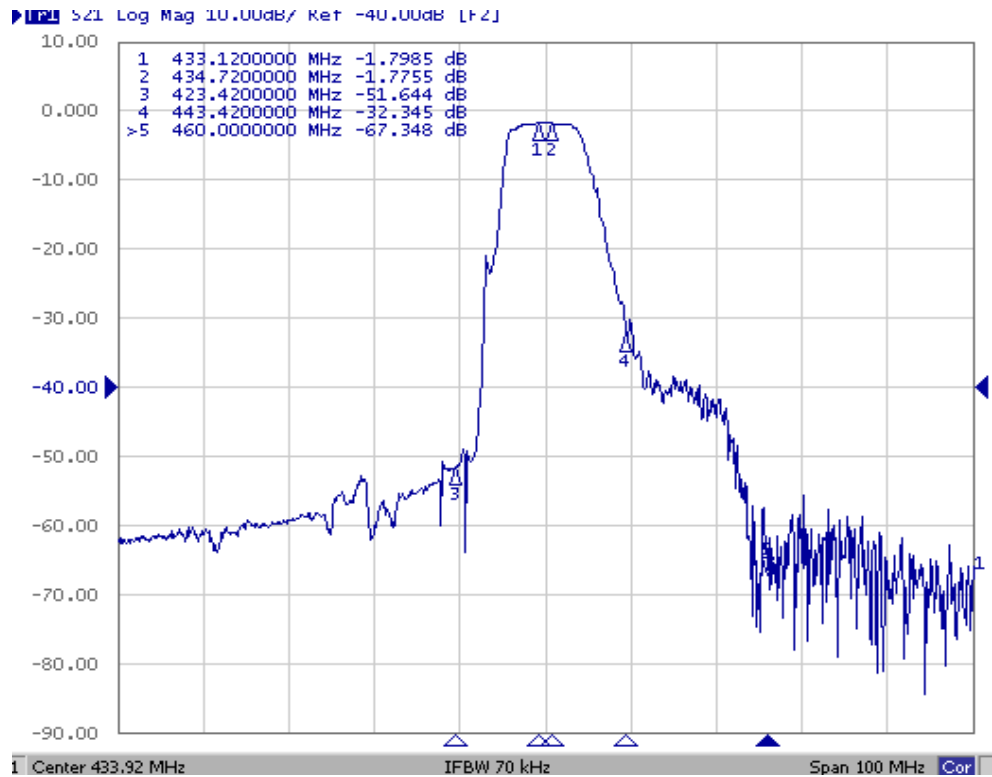
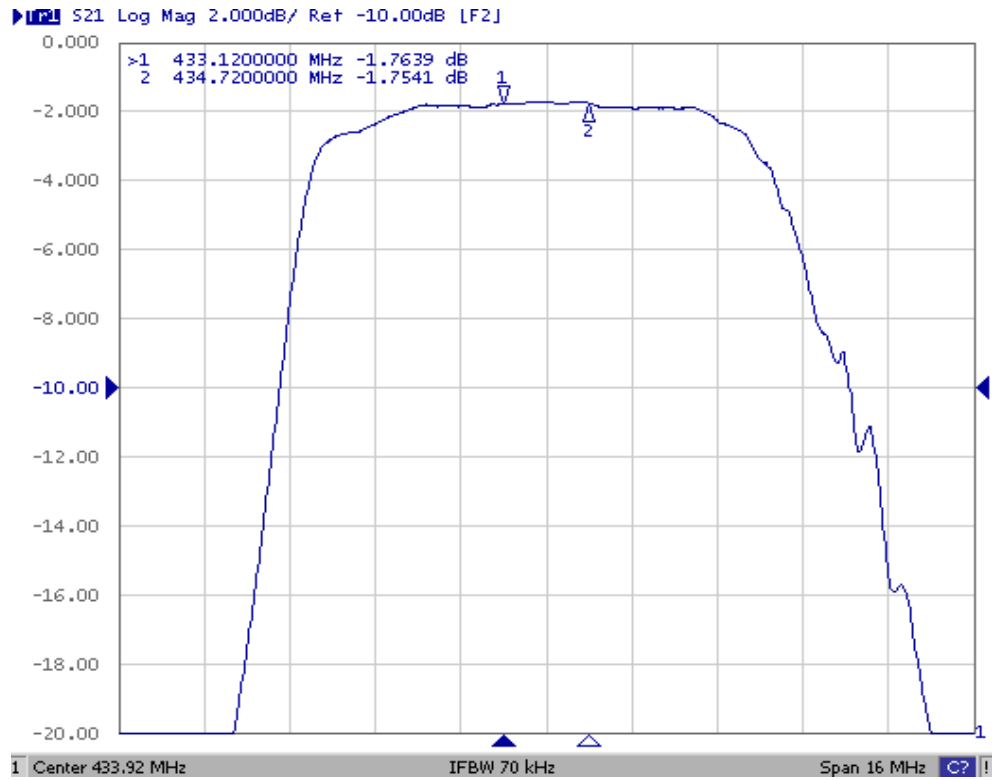

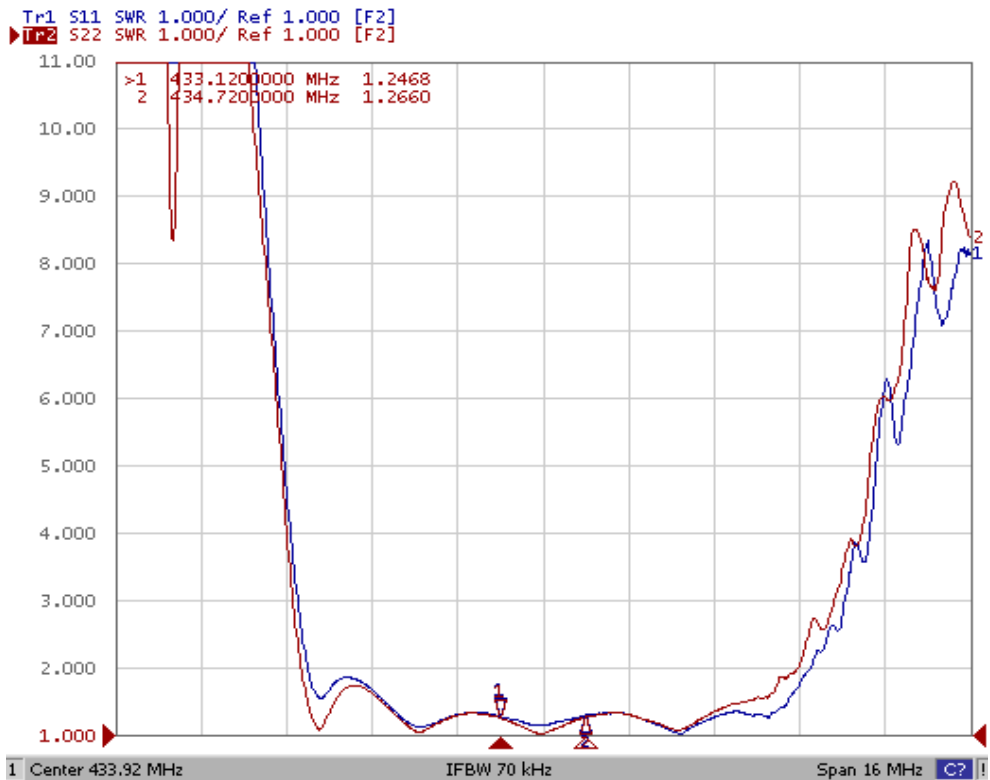
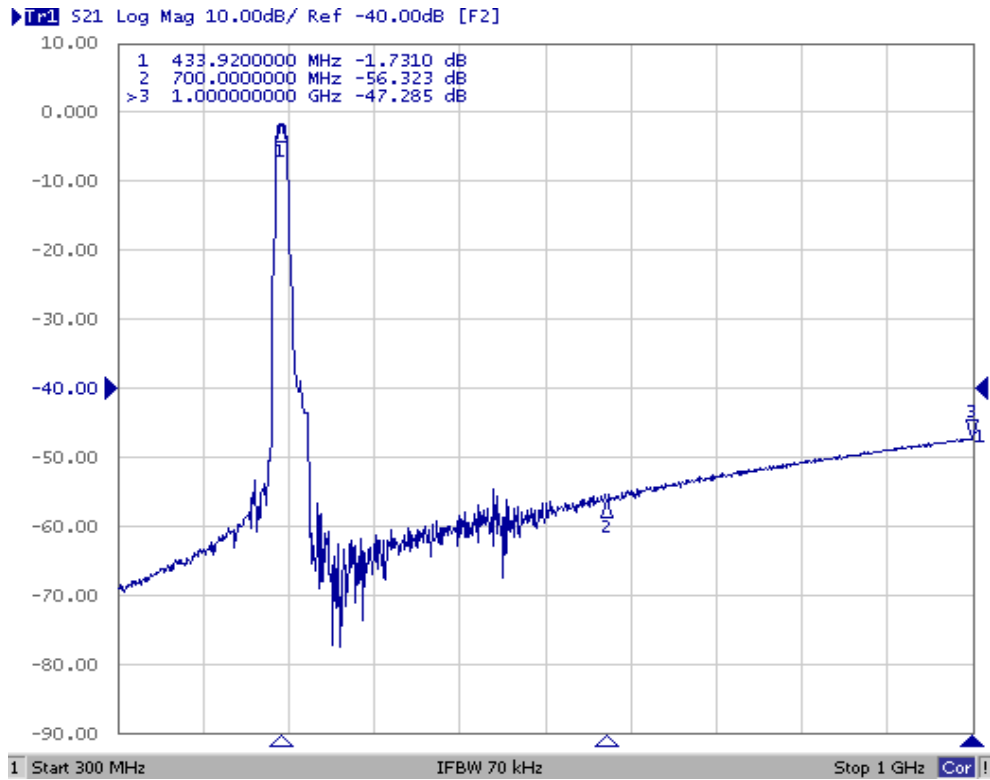

SM3030-6 Case

6-Terminal Ceramic Surface-Mount Case 3.0 X 3.0 mm Nominal Footprint

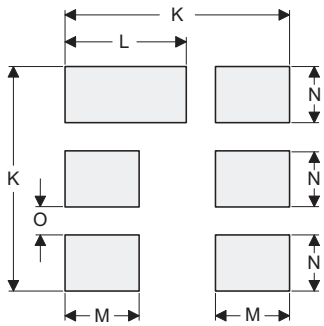
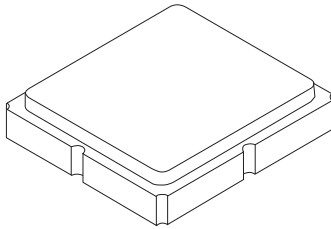

PCB Footprint Top View

Case and PCB Footprint Dimensions

Dimension	mm			Inches		
	Min	Nom	Max	Min	Nom	Max
A	2.87	3.00	3.13	0.113	0.118	0.123
B	2.87	3.00	3.13	0.113	0.118	0.123
C	1.12	1.25	1.38	0.044	0.049	0.054
D	0.77	0.90	1.03	0.030	0.035	0.040
E	2.67	2.80	2.93	0.105	0.110	0.115
F	1.47	1.60	1.73	0.058	0.063	0.068
G	0.72	0.85	0.98	0.028	0.033	0.038
H	1.37	1.50	1.63	0.054	0.059	0.064
I	0.47	0.60	0.73	0.019	0.024	0.029
J	1.17	1.30	1.43	0.046	0.051	0.056
K		3.20			0.126	
L		1.70			0.067	
M		1.05			0.041	
N		0.81			0.032	
O		0.38			0.015	

Case Materials

Materials	
Solder Pad Plating	0.3 to 1.0 μ m Gold over 1.27 to 8.89 μ m Nickel
Lid Plating	2.0 to 3.0 μ m Nickel
Body	Al ₂ O ₃ Ceramic

TOP VIEW

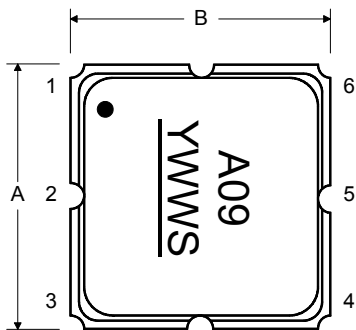

BOTTOM VIEW

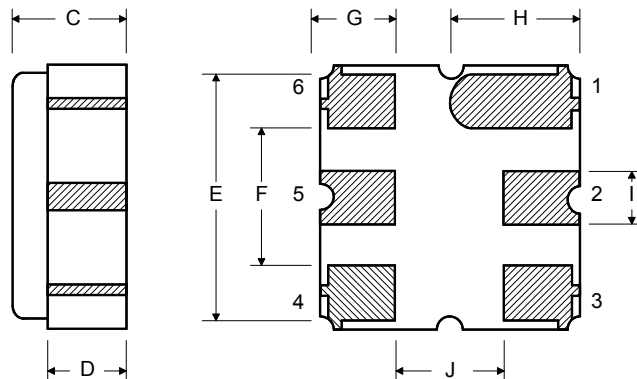

Recommended Reflow Profile

1. Preheating shall be fixed at 150~180°C for 60~90 seconds.
2. Ascending time to preheating temperature 150°C shall be 30 seconds min.
3. Heating shall be fixed at 220°C for 50~80 seconds and at 260°C +0/-5°C peak (10 seconds).
4. Time: 5 times maximum.

