

Features

- GaN on SiC D-Mode Transistor Technology
- Unmatched, Ideal for Pulsed Applications
- 50 V Typical Bias, Class AB
- Common-Source Configuration
- Thermally-Enhanced 3 x 6 mm 14-Lead DFN
- MTTF = 600 years ($T_J < 200^\circ\text{C}$)
- Halogen-Free “Green” Mold Compound
- RoHS* Compliant
- MSL-1

Description

The MAGX-000035-01500P is a GaN on SiC unmatched power device offering the widest RF frequency capability, most reliable high voltage operation, lowest overall power transistor size, cost and weight in a “TRUE SMT” plastic-packaging technology.

Use of an internal stress buffer technology allows reliable operation at junction temperatures up to 200°C . The small package size and excellent RF performance make it an ideal replacement for costly flanged or metal-backed module components.

Ordering Information^{1,2}

Part Number	Package
MAGX-000035-01500P	Bulk Packaging
MAGX-000035-0150TP	250 Piece Reel
MAGX-000035-PB1PPR	Sample Board

1. Reference Application Note M513 for reel size information.
2. When ordering sample evaluation boards, choose a standard frequency range indicated on page 4 or specify a desired custom range. Custom requests may increase lead times.

* Restrictions on Hazardous Substances, European Union Directive 2002/95/EC.



Functional Schematic

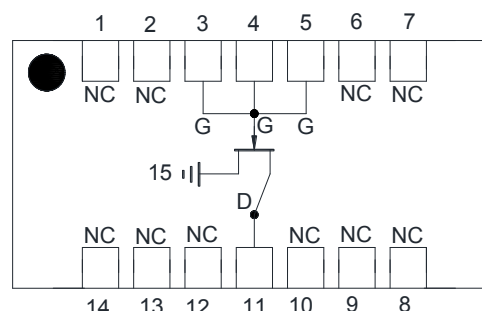

Pin Configuration³

Pin No.	Function	Pin No.	Function
1	No Connection	8	No Connection
2	No Connection	9	No Connection
3	V_{GG}/RF_{IN}	10	No Connection
4	V_{GG}/RF_{IN}	11	V_{DD}/RF_{OUT}
5	V_{GG}/RF_{IN}	12	No Connection
6	No Connection	13	No Connection
7	No Connection	14	No Connection
		15	Paddle ⁴

3. MACOM recommends connecting unused package pins to ground.
4. The exposed pad centered on the package bottom must be connected to RF and DC ground.

GaN Wideband 15 W Pulsed Transistor in Plastic Package DC - 3.5 GHz

Rev. V4

Typical Performance⁵: $V_{DD} = 50\text{ V}$, $I_{DQ} = 35\text{ mA}$, $T_A = 25^\circ\text{C}$

Parameter	30 MHz	1 GHz	2.5 GHz	3.5 GHz	Units
Gain	25	23	17	14	dB
Saturated Power (P_{SAT})	18	16.5	15	14	W
Power Gain at P_{SAT}	22	18	14	11	dB
PAE @ P_{SAT}	75	68	60	55	%

5. Typical RF performance measured in M/A-COM Technology Solutions RF evaluation boards. See recommended tuning solutions on page 4.

Electrical Specifications: Freq. = 1.6 GHz, $T_A = 25^\circ\text{C}$, $Z_0 = 50\ \Omega$

Parameter	Test Conditions	Symbol	Min.	Typ.	Max.	Units
RF FUNCTIONAL TESTS						
CW Output Power (P2.5 dB)	$V_{DD} = 36\text{ V}$, $I_{DQ} = 35\text{ mA}$	P_{OUT}	-	7	-	W
Pulsed Output Power (P2.5 dB) 1 ms and 10% Duty Cycle	$V_{DD} = 50\text{ V}$, $I_{DQ} = 35\text{ mA}$	P_{OUT}	12.5	17	-	W
Pulsed Power Gain (P2.5 dB)	$V_{DD} = 50\text{ V}$, $I_{DQ} = 35\text{ mA}$	G_P	17	19.5	-	dB
Pulsed Drain Efficiency (P2.5 dB)	$V_{DD} = 50\text{ V}$, $I_{DQ} = 35\text{ mA}$	η_D	55	65	-	%
Load Mismatch Stability (P2.5 dB)	$V_{DD} = 50\text{ V}$, $I_{DQ} = 35\text{ mA}$	VSWR-S	-	5:1	-	-
Load Mismatch Tolerance (P2.5 dB)	$V_{DD} = 50\text{ V}$, $I_{DQ} = 35\text{ mA}$	VSWR-T	-	10:1	-	-

Electrical Characteristics: $T_A = 25^\circ\text{C}$

Parameter	Test Conditions	Symbol	Min.	Typ.	Max.	Units
DC CHARACTERISTICS						
Drain-Source Leakage Current	$V_{GS} = -8\text{ V}$, $V_{DS} = 175\text{ V}$	I_{DS}	-	-	1.0	mA
Gate Threshold Voltage	$V_{DS} = 5\text{ V}$, $I_D = 2\text{ mA}$	$V_{GS(th)}$	-5	-3	-2	V
Forward Transconductance	$V_{DS} = 5\text{ V}$, $I_D = 500\text{ mA}$	G_M	0.35	-	-	S
DYNAMIC CHARACTERISTICS						
Input Capacitance	$V_{DS} = 0\text{ V}$, $V_{GS} = -8\text{ V}$, $F = 1\text{ MHz}$	C_{ISS}	-	4.2	-	pF
Output Capacitance	$V_{DS} = 50\text{ V}$, $V_{GS} = -8\text{ V}$, $F = 1\text{ MHz}$	C_{OSS}	-	1.8	-	pF
Reverse Transfer Capacitance	$V_{DS} = 50\text{ V}$, $V_{GS} = -8\text{ V}$, $F = 1\text{ MHz}$	C_{RSS}	-	0.2	-	pF

2

M/A-COM Technology Solutions Inc. (MACOM) and its affiliates reserve the right to make changes to the product(s) or information contained herein without notice. Visit www.macom.com for additional data sheets and product information.

For further information and support please visit:
<https://www.macom.com/support>

Absolute Maximum Ratings^{6,7,8,9,10}

Parameter	Absolute Max.
Input Power	$P_{OUT} - G_P + 2.5 \text{ dBm}$
Drain Supply Voltage, V_{DD}	+65 V
Gate Supply Voltage, V_{GG}	-8 V to 0 V
Supply Current, I_{DD}	800 mA
Power Dissipation, CW @ 85°C	13 W
Power Dissipation (P_{AVG}), Pulsed @ 85°C	17 W
Junction Temperature ¹¹	200°C
Operating Temperature	-40°C to +95°C
Storage Temperature	-65°C to +150°C

6. Exceeding any one or combination of these limits may cause permanent damage to this device.
7. M/A-COM Technology Solutions does not recommend sustained operation near these survivability limits.
8. For saturated performance it is recommended that the sum of $(3 * V_{DD} + \text{abs}(V_{GG})) \leq 175 \text{ V}$.
9. CW operation at V_{DD} voltages above 36 V is not recommended.
10. Operating at nominal conditions with $T_J \leq 200^\circ\text{C}$ will ensure $\text{MTTF} > 1 \times 10^6$ hours. Junction temperature directly affects device MTTF and should be kept as low as possible to maximize lifetime.
11. Junction Temperature (T_J) = $T_C + \Theta_{JC} * ((V * I) - (P_{OUT} - P_{IN}))$

Typical CW thermal resistance (Θ_{JC}) = 15.7°C/W

a) For $T_C = 83^\circ\text{C}$,

$T_J = 200^\circ\text{C}$ @ 36 V, 398 mA, $P_{OUT} = 7.2 \text{ W}$, $P_{IN} = 0.22 \text{ W}$

Typical transient thermal resistances:

b) 300 μs pulse, 10% duty cycle, $\Theta_{JC} = 5.33^\circ\text{C/W}$

For $T_C = 83^\circ\text{C}$,

$T_J = 170^\circ\text{C}$ @ 50 V, 603 mA, $P_{OUT} = 14.3 \text{ W}$, $P_{IN} = 0.41 \text{ W}$

c) 1 ms pulse, 10% duty cycle, $\Theta_{JC} = 5.85^\circ\text{C/W}$

For $T_C = 83^\circ\text{C}$,

$T_J = 172^\circ\text{C}$ @ 50 V, 576 mA, $P_{OUT} = 14.0 \text{ W}$, $P_{IN} = 0.41 \text{ W}$

d) 1 ms pulse, 20% duty cycle, $\Theta_{JC} = 6.81^\circ\text{C/W}$

For $T_C = 83^\circ\text{C}$,

$T_J = 186^\circ\text{C}$ @ 50 V, 570 mA, $P_{OUT} = 13.8 \text{ W}$, $P_{IN} = 0.41 \text{ W}$

Evaluation Board Details and Recommended Tuning Solutions

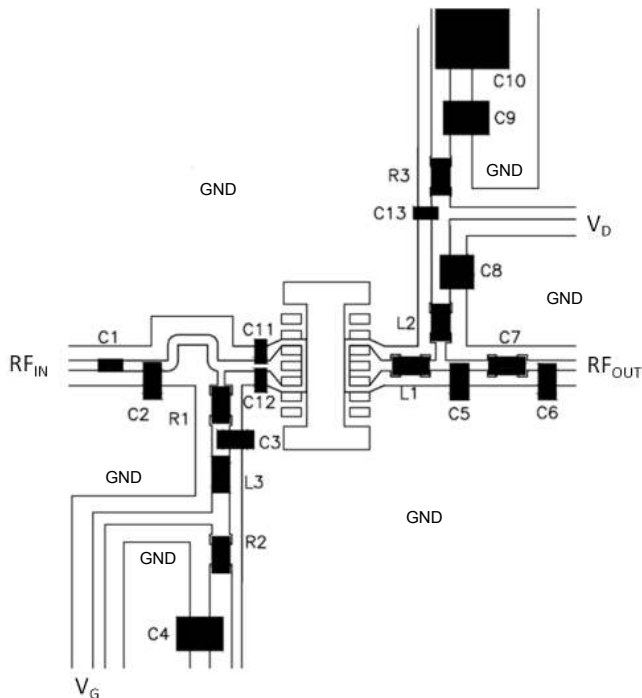

Parts measured on evaluation board (8-mils thick RO4003C). Electrical and thermal ground is provided using copper-filled via hole array (not pictured), and evaluation board is mounted to a metal plate.

Matching is provided using lumped elements as shown at left. Recommended tuning solutions for 3 frequency ranges are detailed in the parts list below.

Bias Sequencing

Turning the device ON

1. Set V_G to the pinch-off (V_P), typically -5 V.
2. Turn on V_D to nominal voltage (50 V).
3. Increase V_{GS} until the I_{DS} current is reached.
4. Apply RF power to desired level.

Turning the device OFF

1. Turn the RF power off.
2. Decrease V_G down to V_P .
3. Decrease V_D down to 0 V.
4. Turn off V_G .

Parts List (N/A = not applicable for this tuning solution)

Part	Frequency = 1.6 GHz	Frequency = 2.2 - 2.5 GHz	Frequency = 2.6 - 3.6 GHz
C1	0402 27 pF, $\pm 5\%$, 200 V, ATC	0402 18 pF, $\pm 5\%$, 200 V, ATC	0402 18 pF, $\pm 5\%$, 200 V, ATC
C2	0603, 5.6 pF, ± 0.1 pF, 250 V, ATC	0402, 2.2 pF, ± 0.1 pF, 200 V, ATC	0402, 1.2 pF, ± 0.1 pF, 200 V, ATC
C3	0603, 18 pF, $\pm 10\%$, 250 V, ATC	N/A	N/A
C4	0805, 1000 pF, 100 V, 5%, AVX	0805, 1000 pF, 100 V, 5%, AVX	0805, 1000 pF, 100 V, 5%, AVX
C5	0505, 2.2 pF, $\pm 5\%$, 250 V, ATC (Vertical)	0603, 0.8 pF, ± 0.1 pF, 250 V, ATC	N/A
C6	N/A	0603, 1.5 pF, ± 0.1 pF, 250 V, ATC	0402, 1.0 pF, ± 0.1 pF, 200 V, ATC
C7	0505, 36 pF, $\pm 5\%$, 250 V, ATC (Vertical)	0402 18 pF, $\pm 5\%$, 200 V, ATC	0402 18 pF, $\pm 5\%$, 200 V, ATC
C8	0505, 18 pF, $\pm 5\%$, 250 V, ATC	0402 10 pF, $\pm 5\%$, 200 V, ATC	N/A
C9	0805, 1000 pF, 100 V, 5%, AVX	0805, 1000 pF, 100 V, 5%, AVX	0805, 1000pF, 100V, 5%, AVX
C10	1210, 1 μ F, 100 V, 20%, ATC	1210, 1 μ F, 100 V, 20%, ATC	1210, 1 μ F, 100 V, 20%, ATC
C11	N/A	0402, 3.9 pF, ± 0.1 pF, 200 V, ATC	0402, 2.0 pF, ± 0.1 pF, 200 V, ATC
C12	N/A	0402, 3.9 pF, ± 0.1 pF, 200 V, ATC	0402, 2.0 pF, ± 0.1 pF, 200 V, ATC
C13	N/A	N/A	0402 10 pF, $\pm 5\%$, 200 V, ATC
R1	12 Ω , 0603, 5%	200 Ω , 0603, 5%	100 Ω , 0603, 5%
R2	1.2 Ω , 0603, 5%	1.0 Ω , 0603, 5%	1.0 Ω , 0603, 5%
R3	1.2 Ω , 0603, 5%	9.1 Ω , 0603, 5%	9.1 Ω , 0603, 5%
L1	0603 HP, 5.1 nH, 5%	0402, 0.8 nH, 10%	Shorting tab
L2	0603 HP, 24 nH, 5%	0603, 1.8 nH, 10%	Shorting tab
L3	N/A	N/A	0603, 10nH, 10%

Lead-Free 3x6 mm 14-Lead DFN[†]

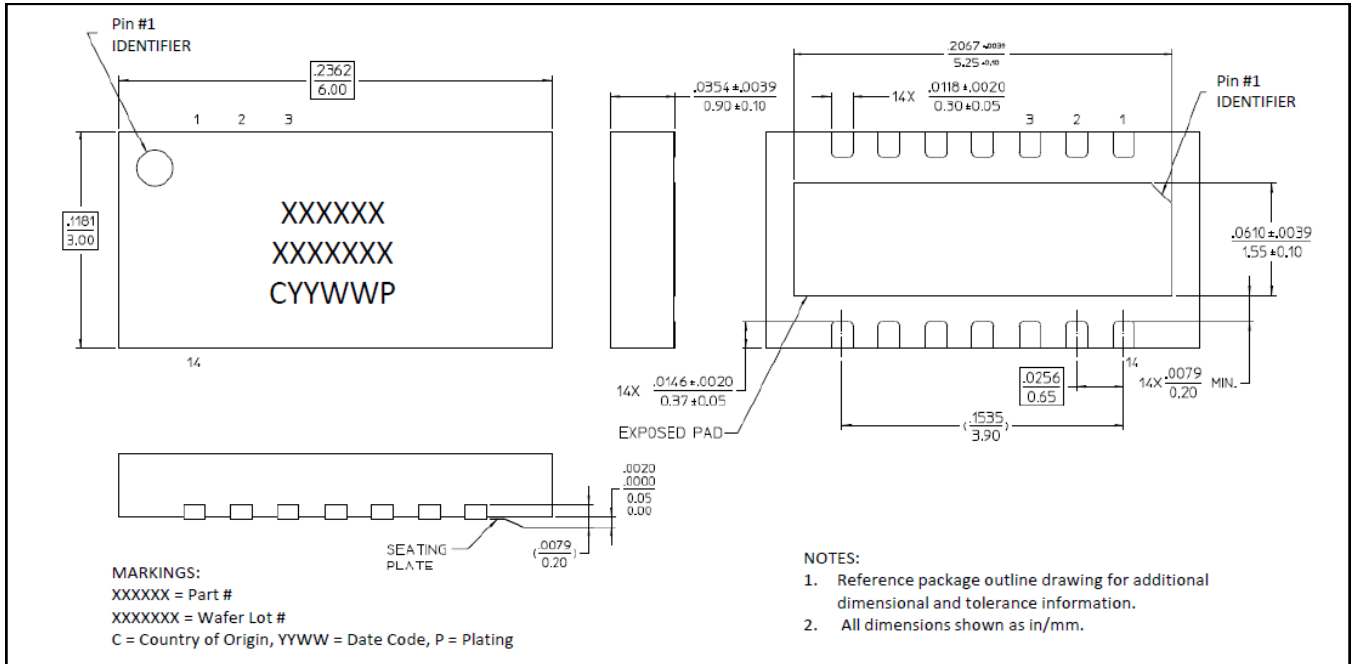

[†] Reference Application Note S2083 for lead-free solder reflow recommendations.
 Meets JEDEC moisture sensitivity level 1 requirements.
 Plating is Ni/Pd/Au.

Handling Procedures

Please observe the following precautions to avoid damage:

Static Sensitivity

Gallium Nitride Devices and Circuits are sensitive to electrostatic discharge (ESD) and can be damaged by static electricity. Proper ESD control techniques should be used when handling these Class 1B devices.

Applications Section

S-Parameter Data: $T_A = 25^\circ\text{C}$, $V_{DD} = +50\text{ V}$, $I_{DQ} = 35\text{ mA}$

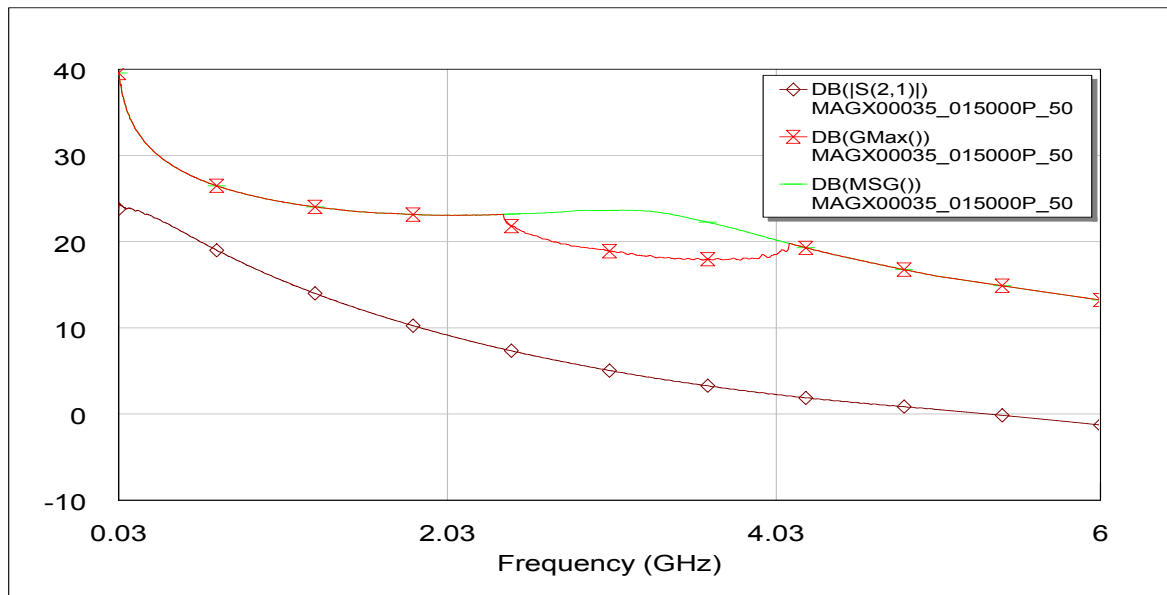
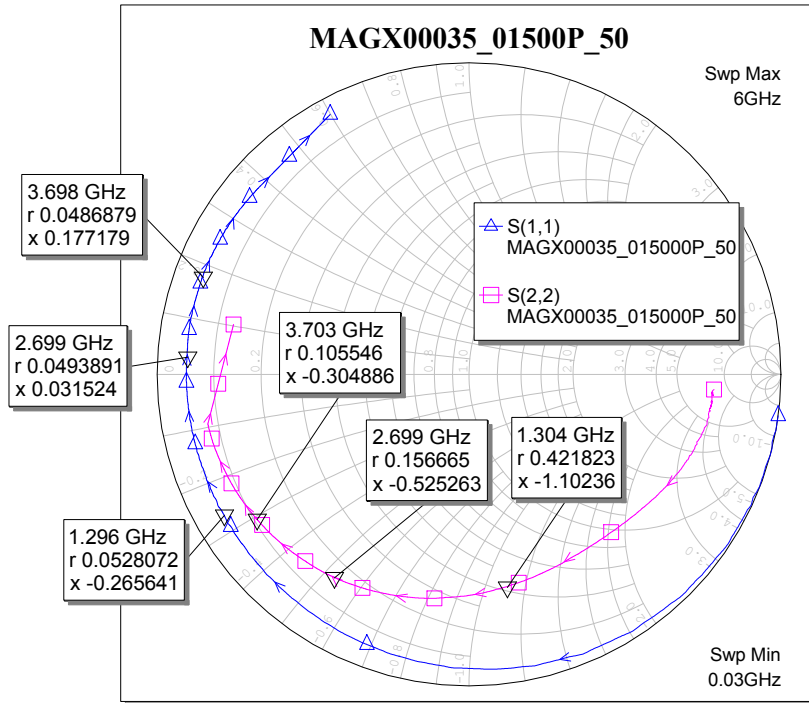

Applications Section

Thermal Performance: Freq. = 1.6 GHz, $T_C = 85^\circ\text{C}$, $V_{DD} = +50\text{ V}$, $I_{DQ} = 25\text{ mA}$, $Z_0 = 50\ \Omega$

Power (Output & Dissipated) vs. Transient Junction Temperature, Pulse Duration and Duty Cycle

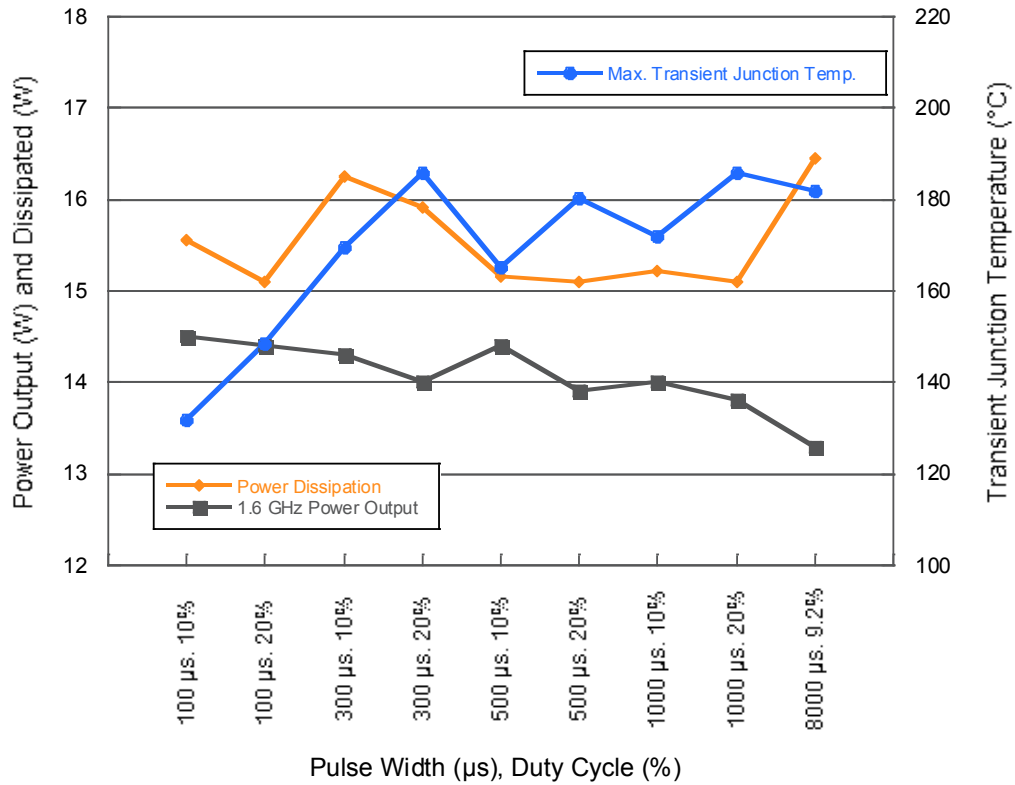

Pulse Width, Duty Cycle	100 μs, 10%	100 μs, 20%	300 μs, 10%	300 μs, 20%	500 μs, 10%	500 μs, 20%	1000 μs, 10%	1000 μs, 20%	8000 μs, 9.2%
Power Dissipation (W)	15.6	15.1	16.3	15.9	15.2	15.1	15.2	15.1	16.5
1.6 GHz P _{OUT} (W)	14.5	14.4	14.3	14	14.4	13.9	14	13.8	13.3
Max. Transient Junction Temp. (°C)	131.9	148.3	169.6	185.9	165.1	180.2	172	185.9	182

Junction temperature measured using High-Speed Transient (HST) temperature detection microscopy.

Applications Section

Typical Performance Curves (reference 1.6 GHz parts list):

1.6 GHz, 1 ms Pulse, 10% Duty Cycle, $V_{DD} = +50\text{ V}$, $T_A = 25^\circ\text{C}$, $Z_0 = 50\ \Omega$

Gain vs. Input Power

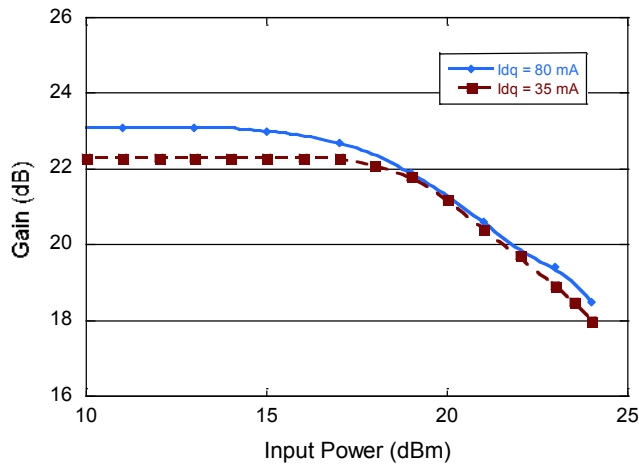

Output Power vs. Input Power

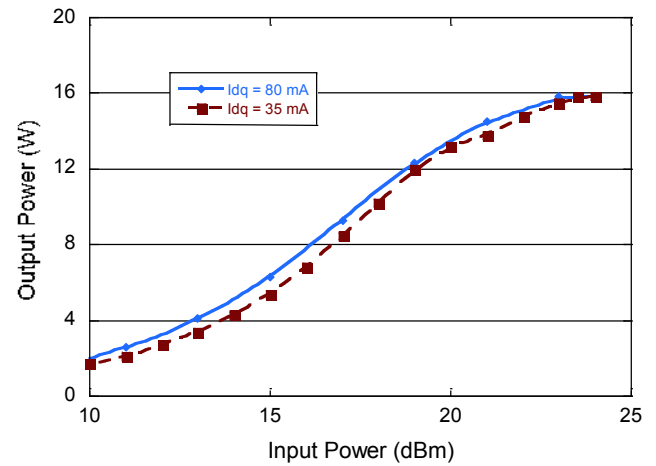

PAE vs. Input Power

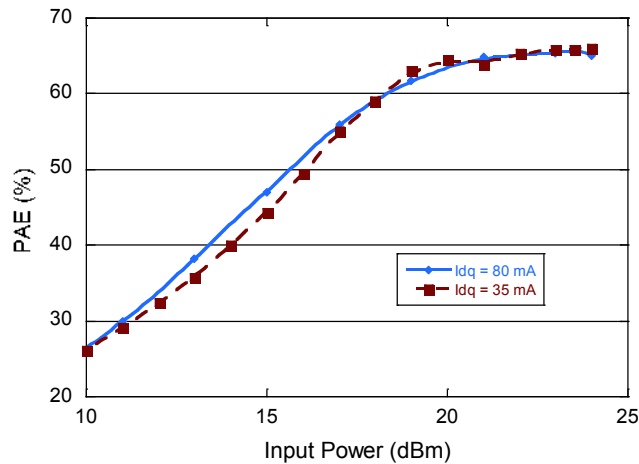

Applications Section

Pulsed OIP3 data

Pulse width 8.28 ms, Duty cycle 9%

$V_{DD} = 50\text{ V}$, $I_{DQ} = 70\text{ mA}$, Freq = 1.62 GHz, 1 MHz spacing on tones

P_{IN} (dBm)	P_{OUT} per tone (dBm)	OIP3 (dBm)
8	31.1	46
9	32.0	47
10	32.9	50
11	33.7	50
12	34.5	47

Typical Performance Curves (reference 2.2 - 2.5 GHz parts list):

2.2 - 2.5 GHz, CW, $V_{DD} = 28\text{ V}$, $I_{DQ} = 35\text{ mA}$, $T_A = 25^\circ\text{C}$, $Z_0 = 50\ \Omega$

Gain vs. Input Power

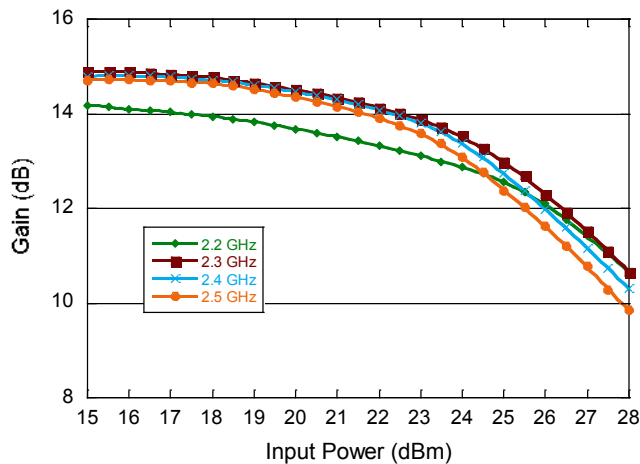

Output Power vs. Input Power

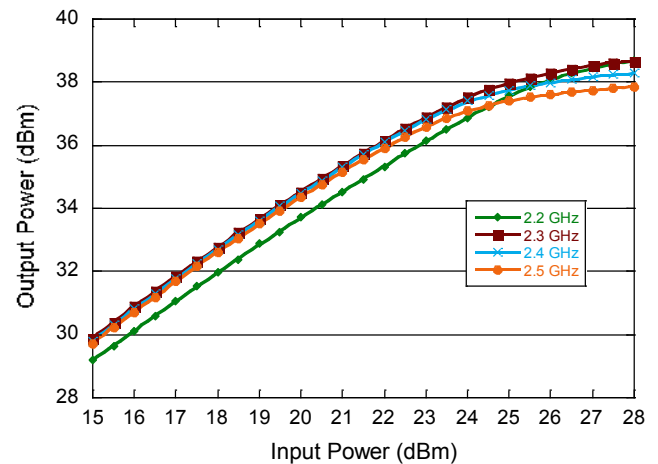

Applications Section

Typical Performance Curves (reference 2.6 - 3.6 GHz parts list):

2.6 - 3.6 GHz, 3 ms Pulse, 10% Duty Cycle, $V_{DD} = 50\text{ V}$, $I_{DQ} = 35\text{ mA}$, $T_A = 25^\circ\text{C}$, $Z_0 = 50\ \Omega$

Gain vs. Frequency

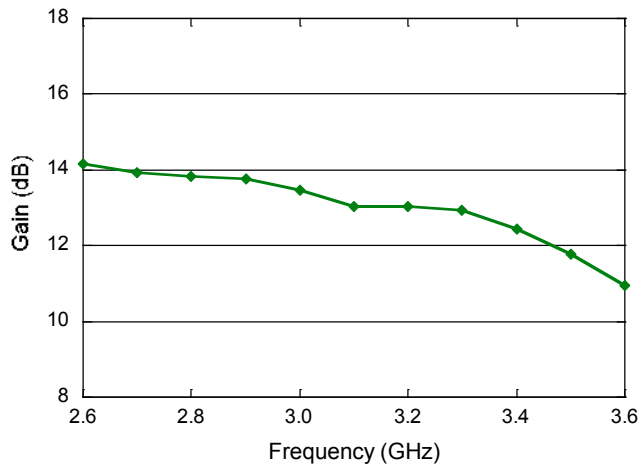

P_{SAT} vs. Frequency

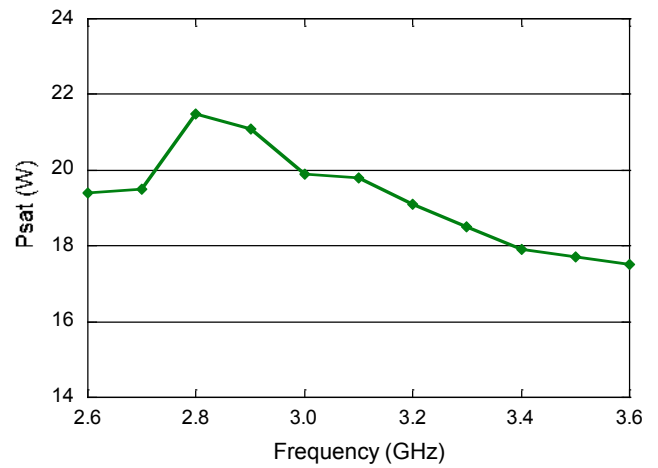

Small Signal Gain vs. Frequency

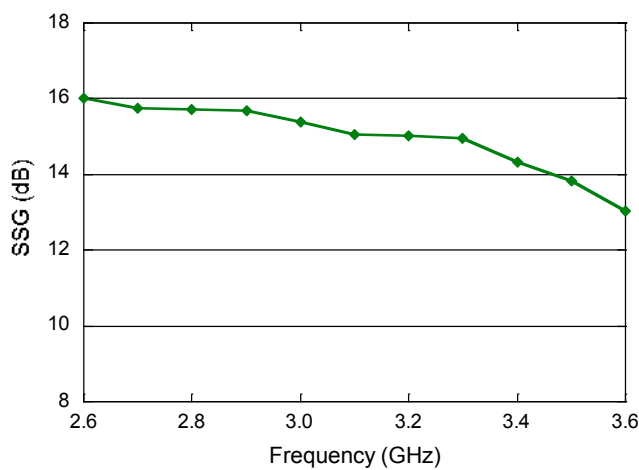

PAE vs. Frequency

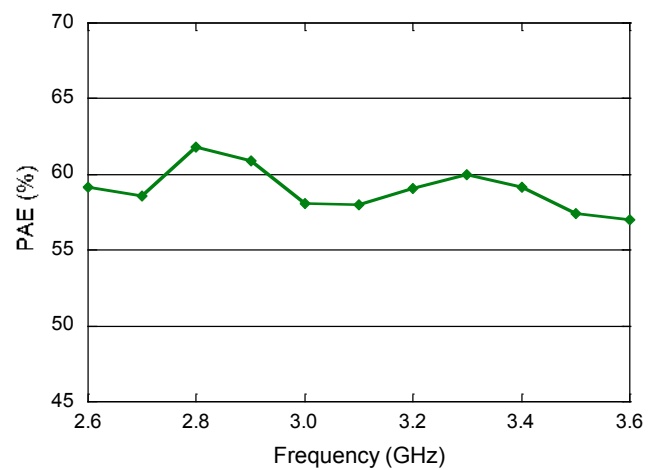

M/A-COM Technology Solutions Inc. All rights reserved.

Information in this document is provided in connection with M/A-COM Technology Solutions Inc ("MACOM") products. These materials are provided by MACOM as a service to its customers and may be used for informational purposes only. Except as provided in MACOM's Terms and Conditions of Sale for such products or in any separate agreement related to this document, MACOM assumes no liability whatsoever. MACOM assumes no responsibility for errors or omissions in these materials. MACOM may make changes to specifications and product descriptions at any time, without notice. MACOM makes no commitment to update the information and shall have no responsibility whatsoever for conflicts or incompatibilities arising from future changes to its specifications and product descriptions. No license, express or implied, by estoppel or otherwise, to any intellectual property rights is granted by this document.

THESE MATERIALS ARE PROVIDED "AS IS" WITHOUT WARRANTY OF ANY KIND, EITHER EXPRESS OR IMPLIED, RELATING TO SALE AND/OR USE OF MACOM PRODUCTS INCLUDING LIABILITY OR WARRANTIES RELATING TO FITNESS FOR A PARTICULAR PURPOSE, CONSEQUENTIAL OR INCIDENTAL DAMAGES, MERCHANTABILITY, OR INFRINGEMENT OF ANY PATENT, COPYRIGHT OR OTHER INTELLECTUAL PROPERTY RIGHT. MACOM FURTHER DOES NOT WARRANT THE ACCURACY OR COMPLETENESS OF THE INFORMATION, TEXT, GRAPHICS OR OTHER ITEMS CONTAINED WITHIN THESE MATERIALS. MACOM SHALL NOT BE LIABLE FOR ANY SPECIAL, INDIRECT, INCIDENTAL, OR CONSEQUENTIAL DAMAGES, INCLUDING WITHOUT LIMITATION, LOST REVENUES OR LOST PROFITS, WHICH MAY RESULT FROM THE USE OF THESE MATERIALS.

MACOM products are not intended for use in medical, lifesaving or life sustaining applications. MACOM customers using or selling MACOM products for use in such applications do so at their own risk and agree to fully indemnify MACOM for any damages resulting from such improper use or sale.