

SST08K-800SW 8A TRIACs

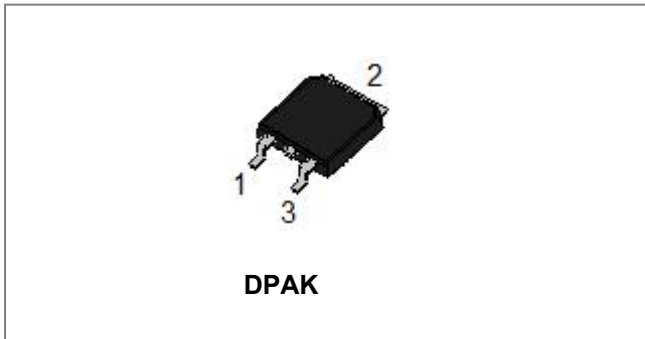

Circuit Diagram

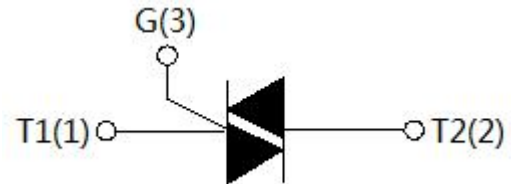

Description

With high ability to withstand the shock loading of large current, SST08K-800SW triacs provide high dv/dt rate with strong resistance to electromagnetic interface. With high commutation performances, 3 quadrants products especially recommended for use on inductive load.

Maximum Ratings:

Characteristics	Symbol	Condition	Max.	Units
Storage junction temperature range	T_{stg}	-	-40 - 150	°C
Operating junction temperature range	T_j	-	-40 - 125	°C
Repetitive peak off-state voltage($T_j=25^{\circ}\text{C}$)	V_{DRM}	-	800	V
Repetitive peak reverse voltage($T_j=25^{\circ}\text{C}$)	V_{RRM}	-	800	V
Non repetitive surge peak Off-state voltage	V_{DSM}	-	$V_{DRM} + 100$	V
Non repetitive peak reverse voltage	V_{RSM}	-	$V_{RRM} + 100$	V
RMS on-state current	$I_{(TRMS)}$	DPAK ($T_c=107^{\circ}\text{C}$)	8	A
Non repetitive surge peak on-state current (full cycle, F=50Hz)	I_{TSM}	-	80	A
I^2t value for fusing ($t_p=10\text{ms}$)	I^2t	-	32	A^2s
Critical rate of rise of on-state current ($I_G = 2 \times I_{GT}$)	di/dt	-	50	$\text{A}/\mu\text{s}$
Peak gate current	I_{GM}	-	4	A
Average gate power dissipation	P_{GM}	-	1	W
Peak gate power	$P_{G(AV)}$	-	5	W

Electrical Characteristics($T_j=25^{\circ}\text{C}$ unless otherwise specified)

Symbol	Test Condition	Quadrant		Value	Unit
				SW	
I_{GT}	$V_D=12\text{V } R_L=33\Omega$	I - II -III	MAX	10	mA
V_{GT}		I - II -III	MAX	1.5	V
V_{GD}	$V_D=V_{DRM} T_j=125^{\circ}\text{C}$ $R_L=3.3\text{K}\Omega$	I - II -III	MIN	0.2	V
I_L	$I_G=1.2I_{GT}$	I -III	MAX	25	mA
		II		35	mA
I_H	$I_T=100\text{mA}$		MAX	20	mA
dV/dt	$V_D=2/3V_{DRM}$ Gate Open $T_j=125^{\circ}\text{C}$		MIN	200	V/ μA

Static Characteristics

Symbol	Condition	Max.	Units
V_{TM}	$I_T=11\text{A } t_p=380\mu\text{s}, T_j=25^{\circ}\text{C}$	1.5	V
I_{DRM}	$V_D=V_{DRM} V_R=V_{RRM}, T_j=25^{\circ}\text{C}$	5	μA
I_{RRM}	$V_D=V_{DRM} V_R=V_{RRM}, T_j=125^{\circ}\text{C}$	1	mA

Thermal Resistances

Symbol	Condition	Value	Units
$R_{th(j-c)}$	Junction to case(AC) DPAK	2.1	$^{\circ}\text{C/W}$

Ordering Information

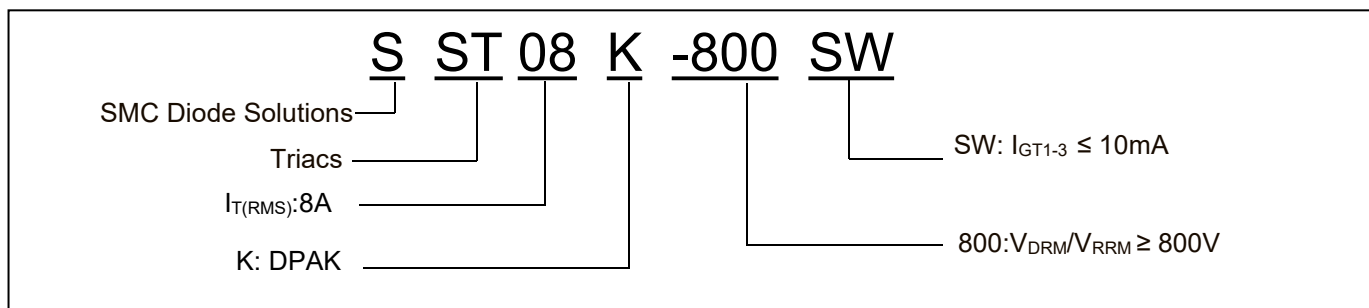

Device	Package	Shipping
SST08K-800SW	DPAK	2500pcs/ Reel

Marking Diagram

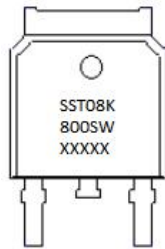

Where XXXXX is YYWWL

SST08K-800SW = Part name
YY = Year
WW = Week
L = Lot Number

Ratings and Characteristics Curves

FIG.1: Maximum power dissipation versus RMS on-state current

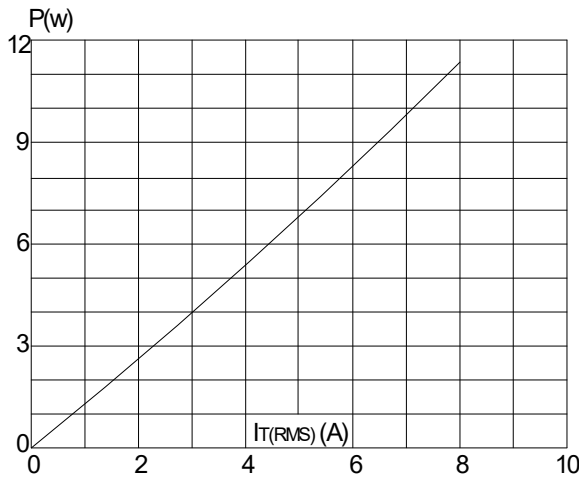

FIG.2: RMS on-state current versus case temperature

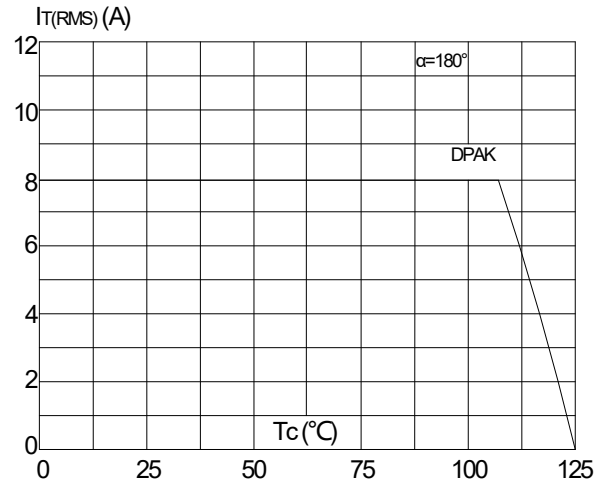

FIG.3: Surge peak on-state current versus number of cycles

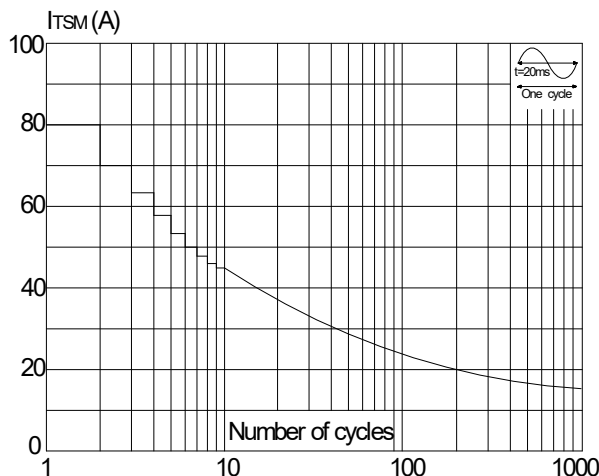

FIG.4: On-state characteristics (maximum values)

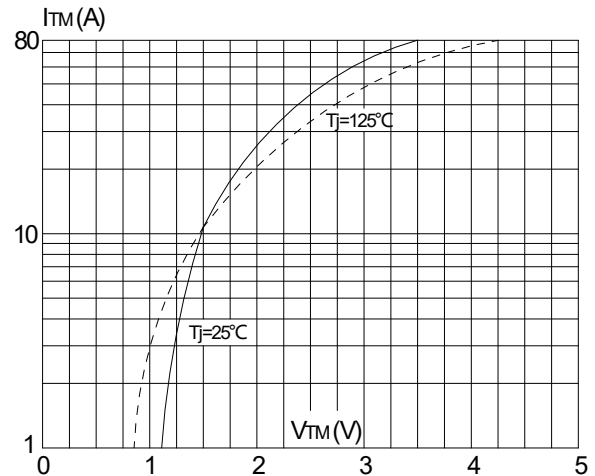

FIG.5: Non-repetitive surge peak on-state current for a sinusoidal pulse with width $t_p < 20\text{ms}$, and corresponding value of I^2t ($dI/dt < 50\text{A}/\mu\text{s}$)

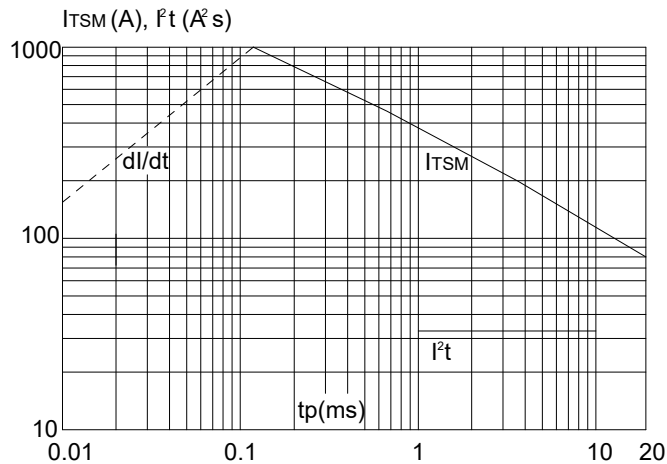
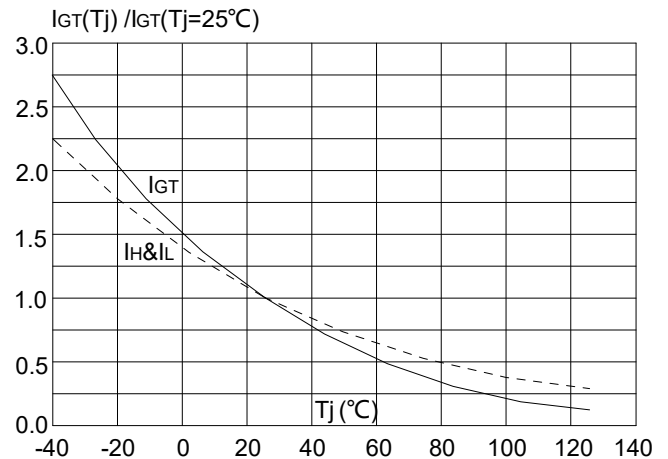

FIG.6: Relative variations of gate trigger current, holding current and latching current versus junction temperature



DISCLAIMER:

- 1- The information given herein, including the specifications and dimensions, is subject to change without prior notice to improve product characteristics. Before ordering, purchasers are advised to contact the SMC Diode Solutions sales department for the latest version of the datasheet(s).
- 2- In cases where extremely high reliability is required (such as use in nuclear power control, aerospace and aviation, traffic equipment, medical equipment, and safety equipment), safety should be ensured by using semiconductor devices that feature assured safety or by means of users' fail-safe precautions or other arrangement.
- 3- In no event shall SMC Diode Solutions be liable for any damages that may result from an accident or any other cause during operation of the user's units according to the datasheet(s). SMC Diode Solution assumes no responsibility for any intellectual property claims or any other problems that may result from applications of information, products or circuits described in the datasheets.
- 4- In no event shall SMC Diode Solutions be liable for any failure in a semiconductor device or any secondary damage resulting from use at a value exceeding the absolute maximum rating.
- 5- No license is granted by the datasheet(s) under any patents or other rights of any third party or SMC Diode Solutions.
- 6- The datasheet(s) may not be reproduced or duplicated, in any form, in whole or part, without the expressed written permission of SMC Diode Solutions.
- 7- The products (technologies) described in the datasheet(s) are not to be provided to any party whose purpose in their application will hinder maintenance of international peace and safety nor are they to be applied to that purpose by their direct purchasers or any third party. When exporting these products (technologies), the necessary procedures are to be taken in accordance with related laws and regulations..