

# External MIMO 4x5G NR + MIMO 2xWiFi + GNSS Combo Antenna



**AECR1808A20**

Request Samples



Check Inventory



**189.0 x 182.0 x 85.0 mm**  
**RoHS/RoHS II Compliant**  
MSL Level = 1

## Features

- Wide band : 600 MHz ~ 6 GHz
- 7 in 1 Combo Antenna
  - 4xMIMO 5GNR/ 4G LTE
  - 2xMIMO Wi-Fi 2.4/5GHz
  - 1x Active GNSS/GPS/GLONASS/BeiDou/QZSS
- Global 4G cellular band coverage including CAT M and NB-IoT
- High Antenna Gain of 4 dBi (Cellular & WiFi)
- High LNA Gain of 28 dB (GNSS)
- IP67 rated
- Easy installation using Screw
- Fully customizable RF cable and connector options

## Applications

- IoT
- M2M
- Smart City
- Telematics
- Transportation
- Smart Agriculture
- Industrial/Automotive
- Geolocation and Tracking

## Product Image



# External MIMO 4x5G NR + MIMO 2xWiFi + GNSS Combo Antenna



**AECR1808A20**

Request Samples



Check Inventory



189.0 x 182.0 x 85.0 mm  
**RoHS/RoHS II Compliant**  
 MSL Level = 1

## Part Number Builder

**AECR1808A20** -

Color / UV Coating	
Code	Description
<b>S</b> (Standard)	Black without UV coating
A	Black with UV Coating
B	White without UV Coating
C	White with UV Coating

Cable length in 'mm'	
Maximum cable length supported : LMR-100 (up to 5000 mm)	
Code	Description
<b>3000</b> (Standard)	3000 mm
Other Examples :	
0200	200 mm
2000	2000 mm

Cable Type & Connector Type				
Code	Cable Type	Connector Type		
		5G NR	GNSS	Wi-Fi
<b>S</b> (Standard)	LMR-100	SMA (M)	SMA (M)	SMA (M)
A		SMA (M)	FAKRA C (F)	SMA (M)
B		FAKRA D (F)	SMA (M)	SMA (M)
C		FAKRA D (F)	FAKRA C (F)	SMA (M)

## Example Configurations :

Part Number	UV Protection Coating / Color	Cable length	Cable Type / Connector Type
AECR1808A20 <b>S-3000S</b>	No / Black	3000 mm	4xLMR-100 with 4xSMA (M) for 5G NR + 1xLMR-100 with 1xSMA (M) for GNSS + 2xLMR-100 with 2xSMA (M) for Wi-Fi (Standard)
AECR1808A20 <b>C-5000C</b>	Yes / White	5000 mm	4xLMR-100 with 4xFAKRA-D (F) for 5G NR + 1xLMR-100 with 1xFAKRA-C (F) for GNSS + 2xLMR-100 with 2xSMA (M) for Wi-Fi

## Note :

- For the standard part number (AECR1808A20**S-3000S**), please refer to the packaging at the end of the document.
- For additional configuration (AECR1808A20-), MOQs, pricing and packaging changes may be applicable.



5101 Hidden Creek Ln Spicewood TX 78669  
 Phone: 512-371-6159 | Fax: 512-351-8858  
 For terms and conditions of sales, please visit:  
[www.abracon.com](http://www.abracon.com)

REVISED: 01-03-20

ABRACON IS  
 ISO9001-2015  
 CERTIFIED

# External MIMO 4x5G NR + MIMO 2xWiFi + GNSS Combo Antenna



**AECR1808A20**

Request Samples



Check Inventory



189.0 x 182.0 x 85.0 mm  
**RoHS/RoHS II Compliant**  
 MSL Level = 1

## Electrical Specifications

Parameter	Specification			Unit
	Min	Typ	Max	
<b>MIMO 4x 5G NR (Main + Aux)</b>				
Operating Frequency	600		6000	MHz
VSWR			4.0	
Peak Gain			4	dBi
Impedance		50		$\Omega$
Polarization	Linear			
Power Rating			10	W
<b>MIMO 2x Wi-Fi (Main + Aux)</b>				
Operating Frequency	2400		2483.5	MHz
	4900		5925	
VSWR			2.5	
Peak Gain			4	dBi
Impedance		50		$\Omega$
Polarization	Linear			
Power Rating			10	W
<b>1x GNSS (25x25x4 mm Patch)</b>				
Operating Frequency	1561.098		1606	MHz
Peak Gain			3	dBi
VSWR			2.0	
Impedance		50		$\Omega$
Polarization	RHCP			
LNA Gain	26	28	30	dBi
LNA NF			1.5	dB
Supply Voltage (DC)	3		5	V
Current Consumption			15	mA

## Mechanical Specifications

Parameter	Specification
Antenna Dimension	189 x 182 x 85 mm
Material	PC/ABS
Mounting Type	Screw
RF Cable Type	7x LMR-100 (LTE, Wi-Fi, GNSS)
RF Cable Length	3 m
RF Connector	7x SMA (M)
Mounting Torque	Recommended
	Maximum
	1.5 ~ 3 Nm
	5 Nm



5101 Hidden Creek Ln Spicewood TX 78669  
 Phone: 512-371-6159 | Fax: 512-351-8858  
 For terms and conditions of sales, please visit:  
[www.abracon.com](http://www.abracon.com)

**REVISED: 01-03-20**

ABRACON IS  
 ISO9001-2015  
 CERTIFIED

# External MIMO 4x5G NR + MIMO 2xWiFi + GNSS Combo Antenna



**AECR1808A20**

Request Samples



Check Inventory



**189.0 x 182.0 x 85.0 mm**  
**RoHS/RoHS II Compliant**  
**MSL Level = 1**

## Environmental Specification

Parameter	Specification
Operating Temperature	-40°C to +85°C
Storage Temperature	-40°C to +85°C
IP Rating	IP67 (Excluding Cable Outlet)
UL Rating	UL-HB
RoHS Compliance	Yes
PB Free	Yes
MSL	1
ESD Sensitive	Yes
Relative Humidity	Up to 95%
Vibration	10 ~ 55 Hz with 1.5 mm amplitude 2 hrs

## Product Dimension

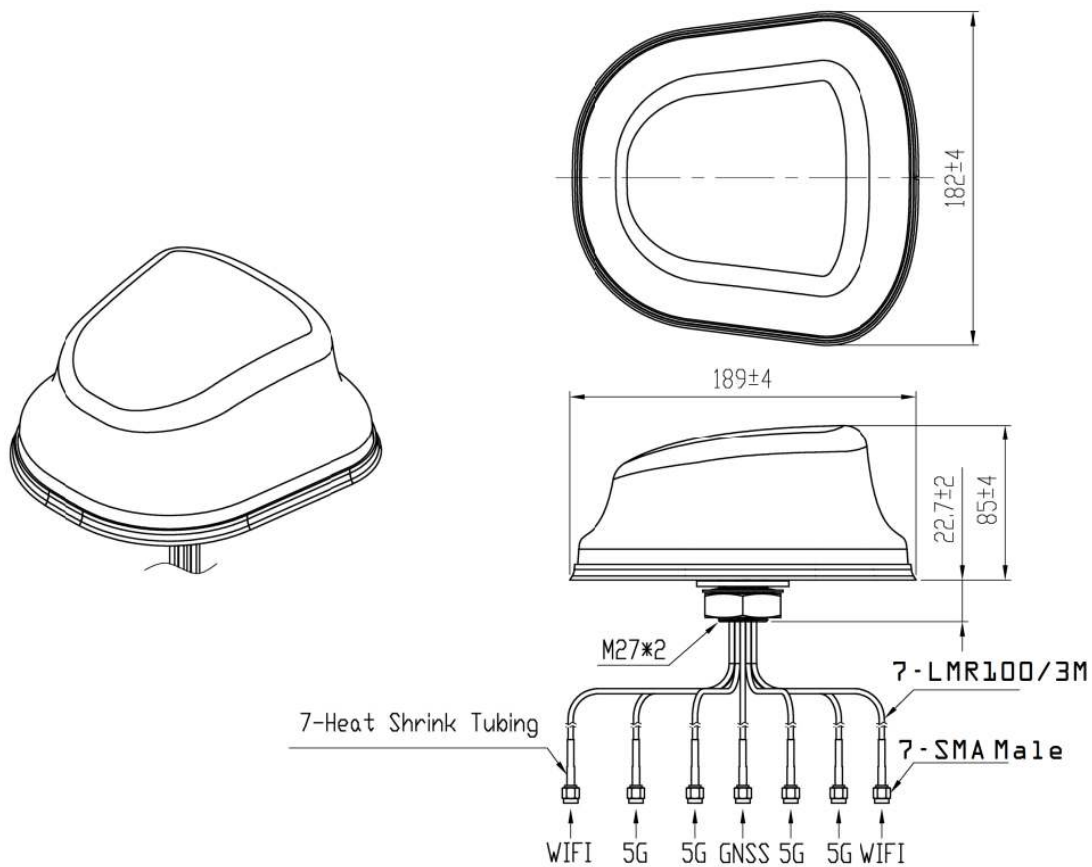

Unit : mm



5101 Hidden Creek Ln Spicewood TX 78669  
 Phone: 512-371-6159 | Fax: 512-351-8858  
 For terms and conditions of sales, please visit:  
[www.abracon.com](http://www.abracon.com)

**REVISED: 01-03-20**

ABRACON IS  
 ISO9001-2015  
 CERTIFIED

# External MIMO 4x5G NR + MIMO 2xWiFi + GNSS Combo Antenna



**AECR1808A20**

Request Samples



Check Inventory



**189.0 x 182.0 x 85.0 mm**  
**RoHS/RoHS II Compliant**  
**MSL Level = 1**

## Test Measurement - VSWR

### Cellular – 5G NR

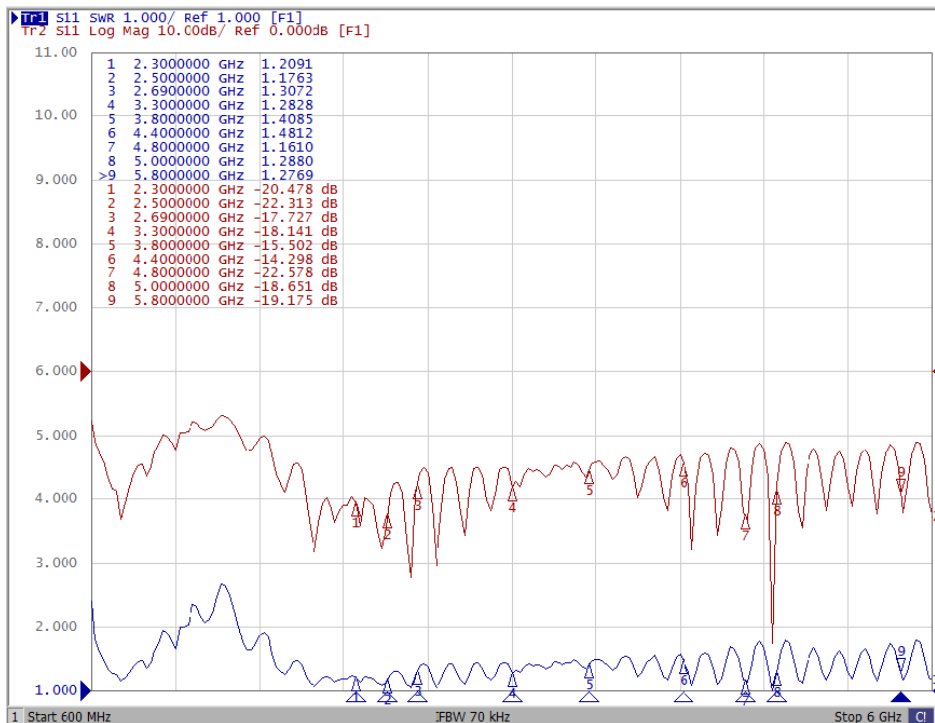
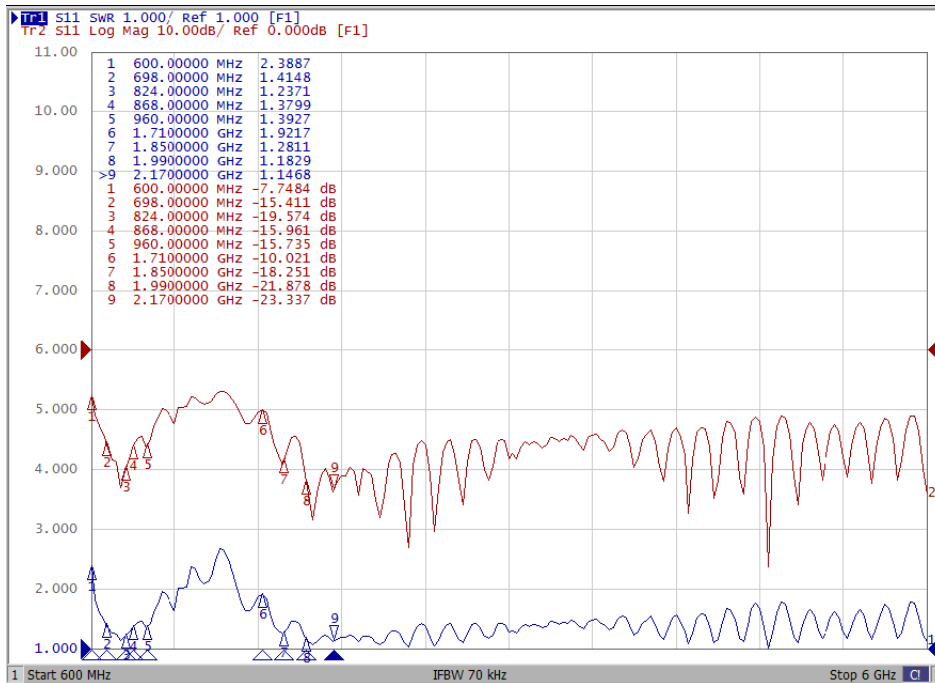

5101 Hidden Creek Ln Spicewood TX 78669  
 Phone: 512-371-6159 | Fax: 512-351-8858  
 For terms and conditions of sales, please visit:  
[www.abracon.com](http://www.abracon.com)

REVISED: 01-03-20

ABRACON IS  
 ISO9001-2015  
 CERTIFIED

# External MIMO 4x5G NR + MIMO 2xWiFi + GNSS Combo Antenna



**AECR1808A20**

Request Samples



Check Inventory



**189.0 x 182.0 x 85.0 mm**  
**RoHS/RoHS II Compliant**  
MSL Level = 1

## Wi-Fi

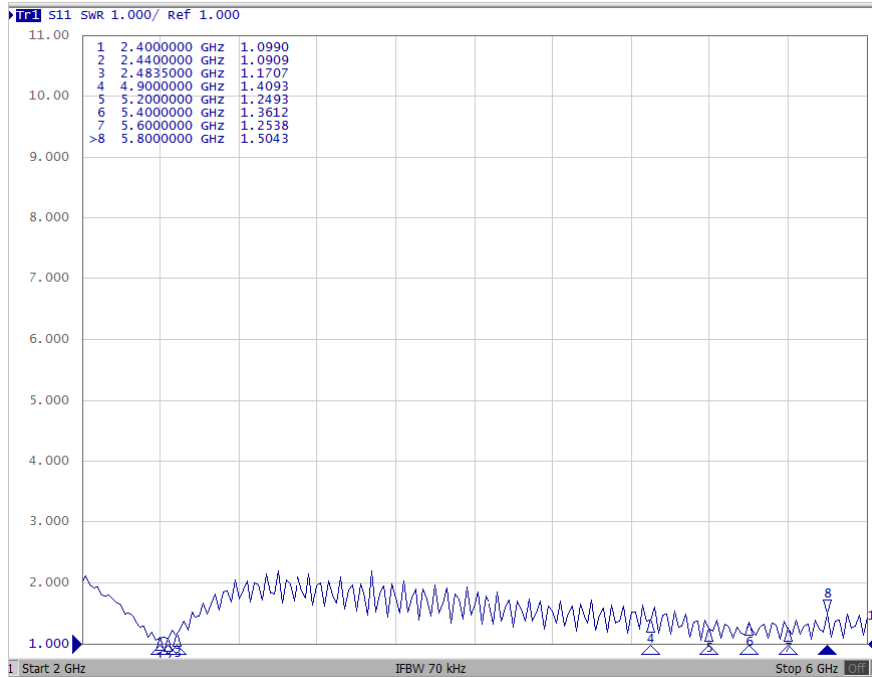

## GNSS

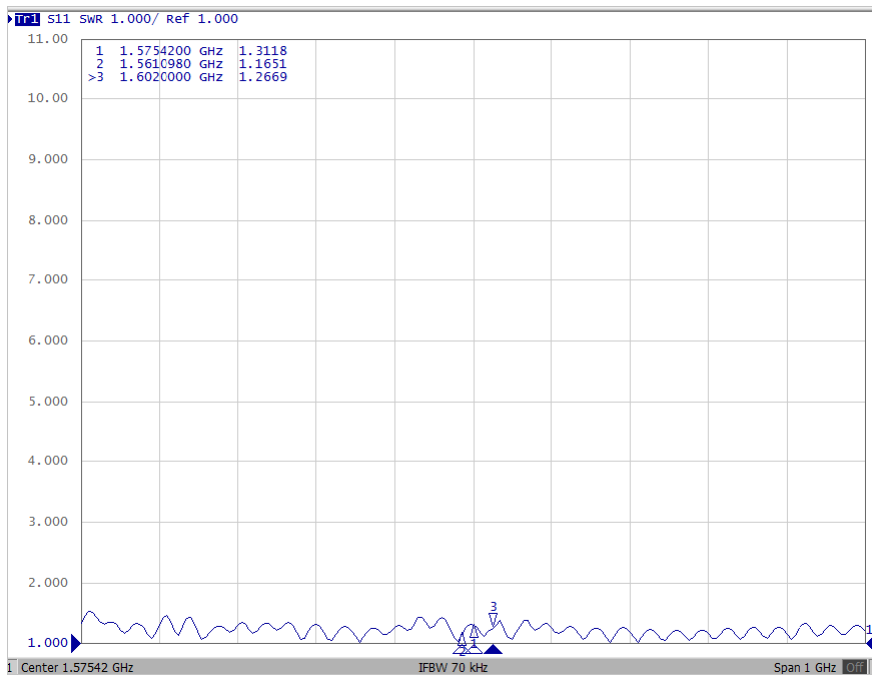

5101 Hidden Creek Ln Spicewood TX 78669  
Phone: 512-371-6159 | Fax: 512-351-8858  
For terms and conditions of sales, please visit:  
[www.abracon.com](http://www.abracon.com)

REVISED: 01-03-20

ABRACON IS  
ISO9001-2015  
CERTIFIED

# External MIMO 4x5G NR + MIMO 2xWiFi + GNSS Combo Antenna



AECR1808A20

Request Samples



Check Inventory



189.0 x 182.0 x 85.0 mm  
RoHS/RoHS II Compliant  
MSL Level = 1

## Radiation Characteristics

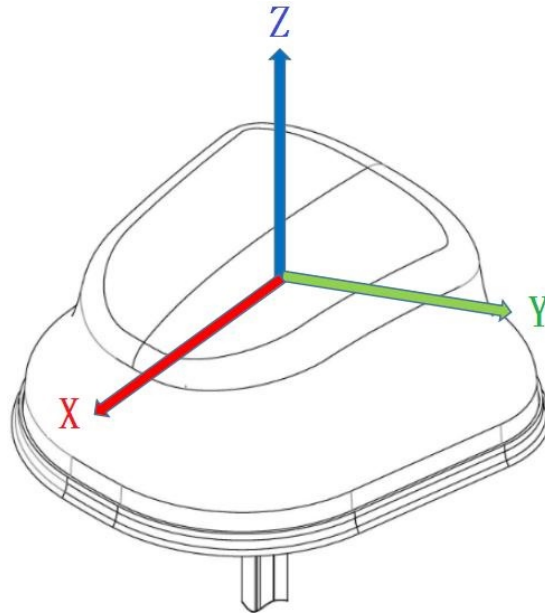

## GNSS

### 2D Pattern

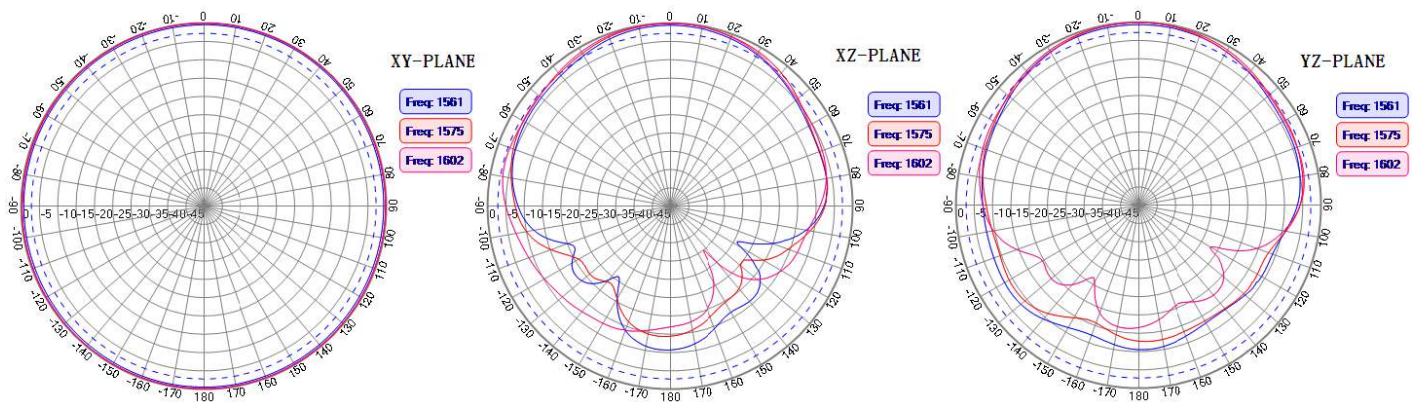

# External MIMO 4x5G NR + MIMO 2xWiFi + GNSS Combo Antenna



**AECR1808A20**

Request Samples



Check Inventory



**189.0 x 182.0 x 85.0 mm**  
**RoHS/RoHS II Compliant**  
**MSL Level = 1**

## MIMO 4x 5G NR : Main & Aux

### 2D Pattern

#### XY - Plane

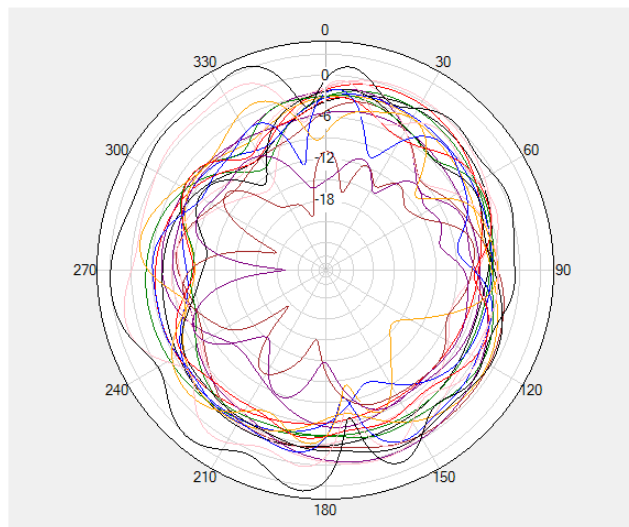

#### XZ - Plane

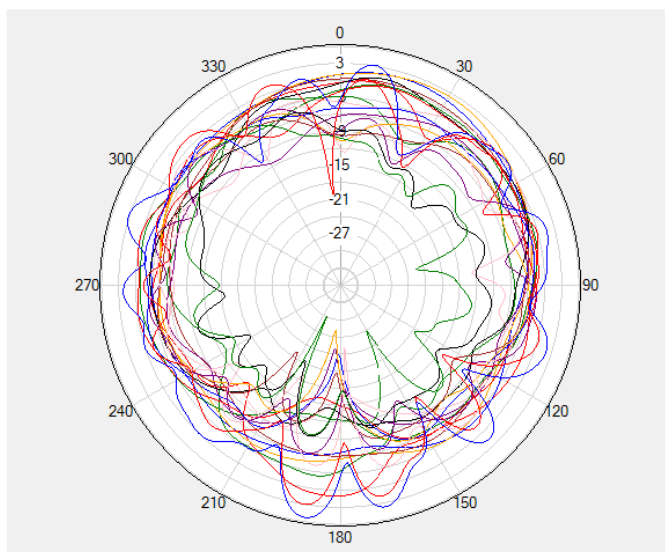

#### YZ - Plane

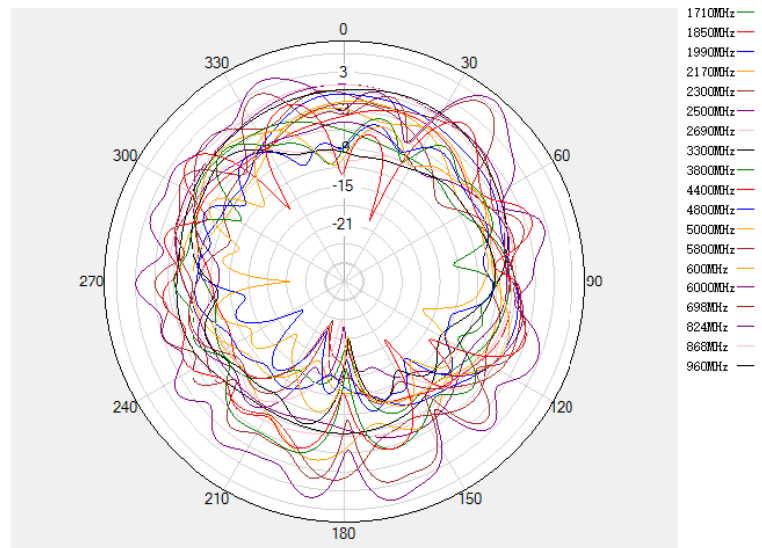

5101 Hidden Creek Ln Spicewood TX 78669  
 Phone: 512-371-6159 | Fax: 512-351-8858  
 For terms and conditions of sales, please visit:  
[www.abracon.com](http://www.abracon.com)

**REVISED: 01-03-20**

ABRACON IS  
 ISO9001-2015  
 CERTIFIED



# External MIMO 4x5G NR + MIMO 2xWiFi + GNSS Combo Antenna



**AECR1808A20**

Request Samples



Check Inventory



**189.0 x 182.0 x 85.0 mm**  
**RoHS/RoHS II Compliant**  
**MSL Level = 1**

## 3D Pattern

600 MHz

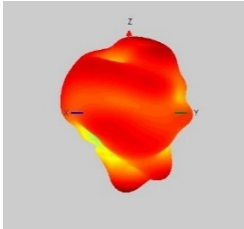

698 MHz

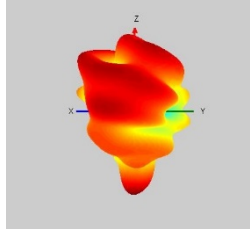

824 MHz

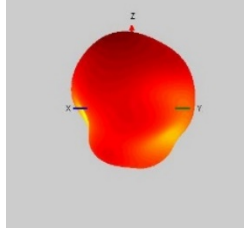

868 MHz

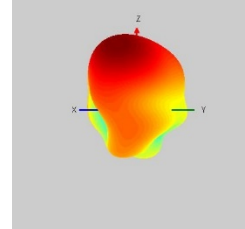

960 MHz

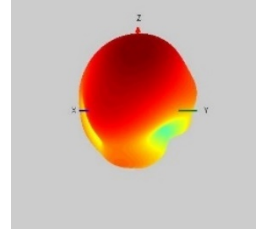

1710 MHz

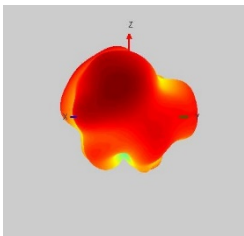

1850 MHz

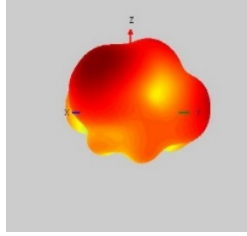

1990 MHz

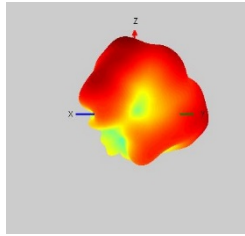

2170 MHz

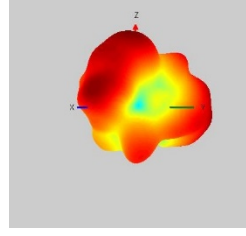

2300 MHz

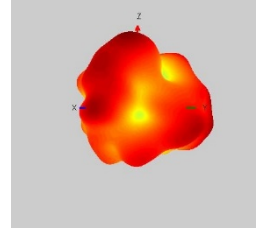

2500 MHz

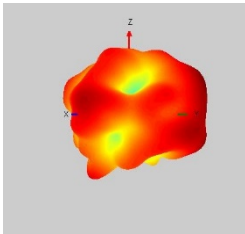

2690 MHz

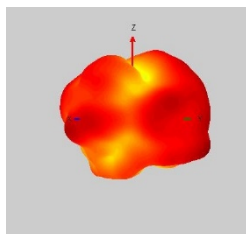

3300 MHz

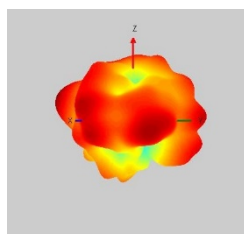

3800 MHz

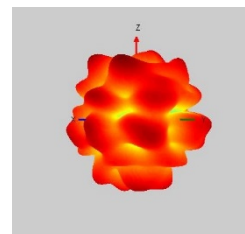

4400 MHz

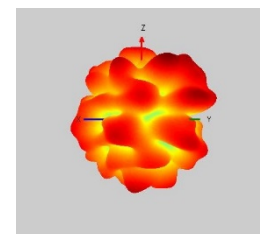

4800 MHz

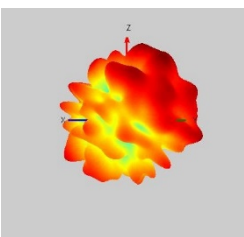

5000 MHz

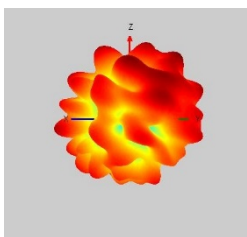

5800 MHz

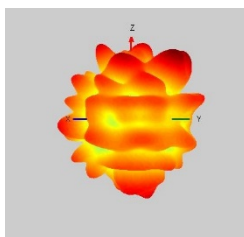

6000 MHz

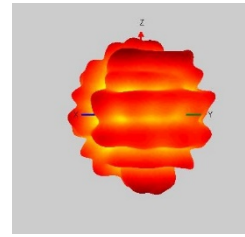

# External MIMO 4x5G NR + MIMO 2xWiFi + GNSS Combo Antenna



**AECR1808A20**

Request Samples



Check Inventory



**189.0 x 182.0 x 85.0 mm**  
**RoHS/RoHS II Compliant**  
**MSL Level = 1**

## MIMO 2xWi-Fi : Main & Aux

### 2D Pattern

#### XY - Plane

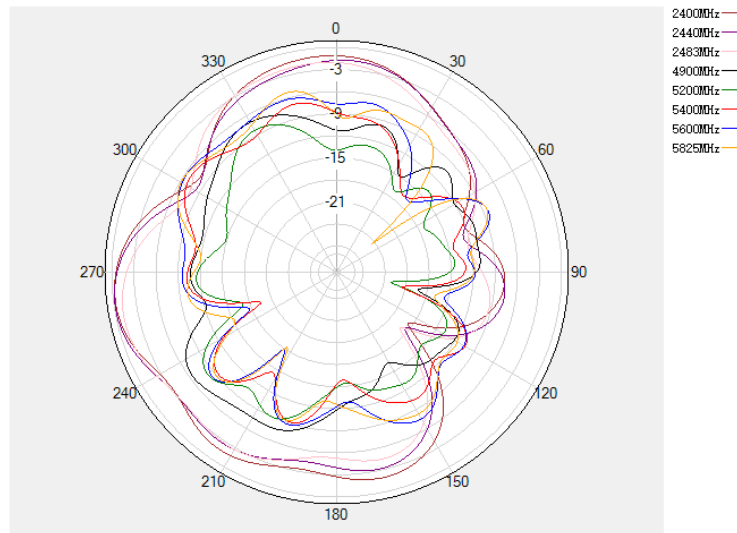

#### XZ - Plane

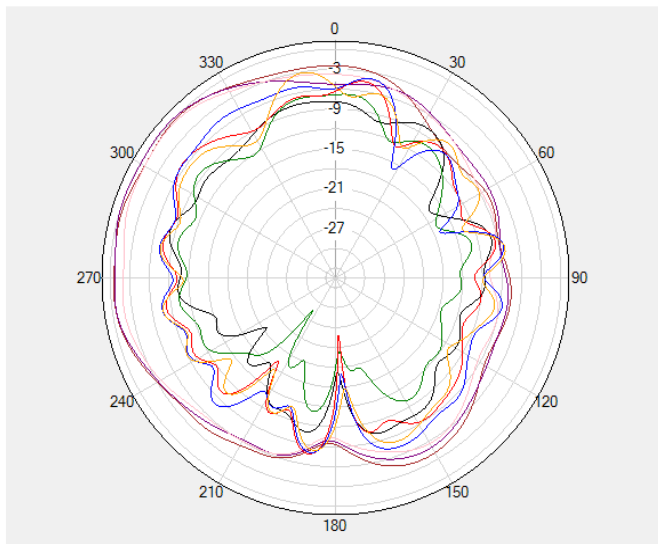

#### YZ - Plane

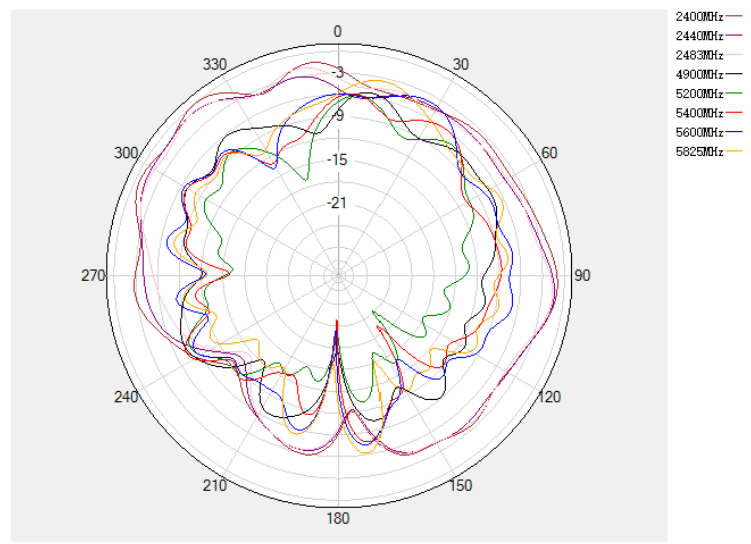

5101 Hidden Creek Ln Spicewood TX 78669  
Phone: 512-371-6159 | Fax: 512-351-8858  
For terms and conditions of sales, please visit:  
[www.abracon.com](http://www.abracon.com)

**REVISED: 01-03-20**

ABRACON IS  
ISO9001-2015  
CERTIFIED

# External MIMO 4x5G NR + MIMO 2xWiFi + GNSS Combo Antenna



AECR1808A20

Request Samples



Check Inventory



189.0 x 182.0 x 85.0 mm  
RoHS/RoHS II Compliant  
MSL Level = 1

## 3D Pattern

2400 MHz

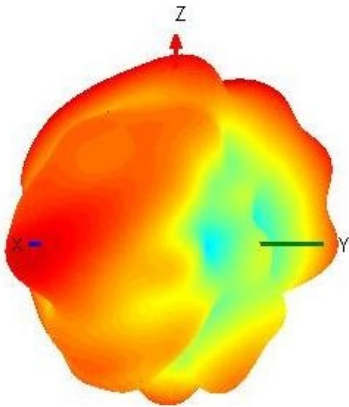

2440 MHz

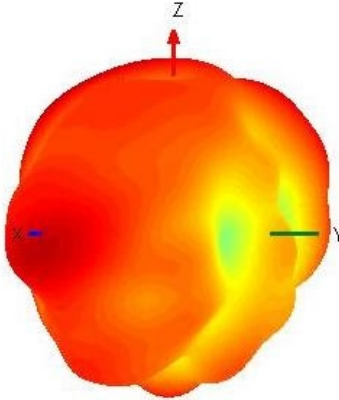

2483 MHz

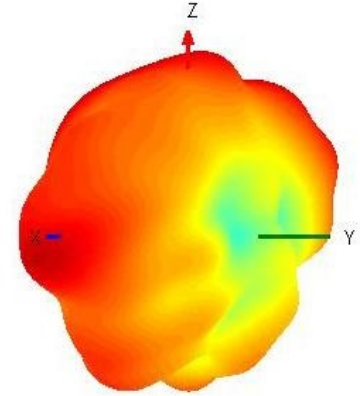

4900 MHz

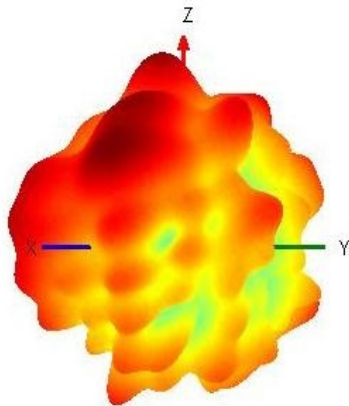

5200 MHz

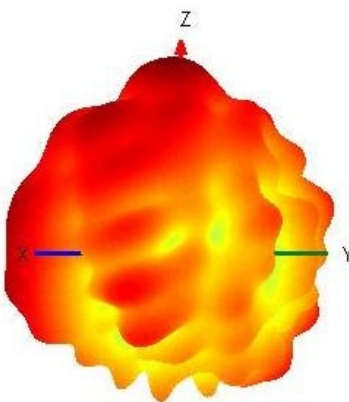

5400 MHz

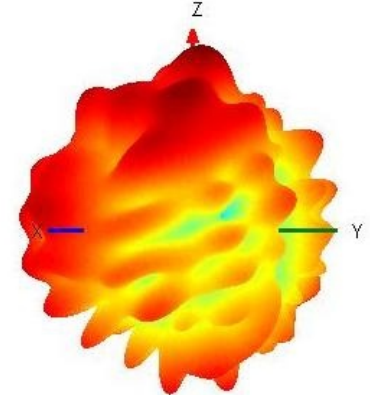

5600 MHz

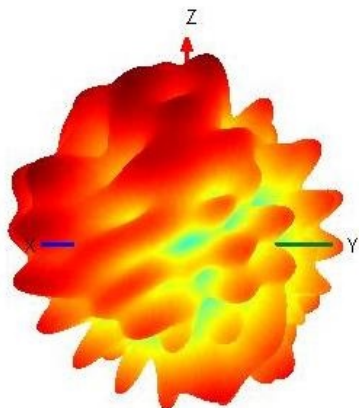

5825 MHz

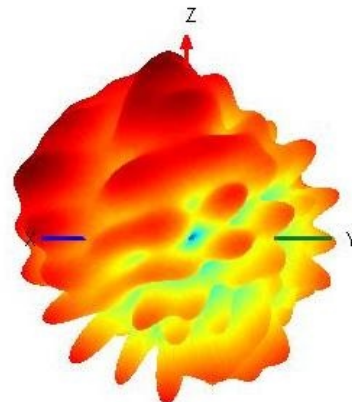

# External MIMO 4x5G NR + MIMO 2xWiFi + GNSS Combo Antenna



**AECR1808A20**

Request Samples



Check Inventory



189.0 x 182.0 x 85.0 mm  
**RoHS/RoHS II Compliant**  
 MSL Level = 1

## Efficiency & Gain

Frequency (MHz)	Efficiency	Gain (dBi)
<b>MIMO 4x 5G NR (Main + Aux)</b>		
600	0.63	1.05
698	0.68	1.97
824	0.69	3.17
868	0.56	1.37
960	0.69	1.69
1710	0.58	0.76
1850	0.57	0.89
1990	0.59	0.77
2170	0.62	2.29
2300	0.63	2.34
2500	0.59	2.17
2690	0.60	1.27
3300	0.53	-0.47
3800	0.51	-1.51
4400	0.66	2.08
4800	0.56	-0.19
5000	0.59	-0.62
5800	0.58	4.25
6000	0.58	4.17
<b>MIMO 2x Wi-Fi (Main + Aux)</b>		
2400	0.56	3.97
2440	0.53	2.53
2483	0.57	1.45
4900	0.55	-0.17
5200	0.49	-0.41
5400	0.51	1.05
5600	0.48	0.67
5825	0.51	3.37



5101 Hidden Creek Ln Spicewood TX 78669  
 Phone: 512-371-6159 | Fax: 512-351-8858  
 For terms and conditions of sales, please visit:  
[www.abracon.com](http://www.abracon.com)

**REVISED: 01-03-20**

ABRACON IS  
 ISO9001-2015  
 CERTIFIED

# External MIMO 4x5G NR + MIMO 2xWiFi + GNSS Combo Antenna



**AECR1808A20**

Request Samples



Check Inventory



**189.0 x 182.0 x 85.0 mm**  
**RoHS/RoHS II Compliant**  
**MSL Level = 1**

## Packaging Information

Number of Antenna/ Carton : 8 pcs  
Dimension of the Carton : 430 x 430 x 340 mm  
Weight of 1 pc of antenna : 1.1 kg  
Weight of the Carton : 10 kg

**ATTENTION:** Abracon LLC's products are COTS – Commercial-Off-The-Shelf products; suitable for Commercial, Industrial and, where designated, Automotive Applications. Abracon's products are not specifically designed for Military, Aviation, Aerospace, Life-dependent Medical applications or any application requiring high reliability where component failure could result in loss of life and/or property. For applications requiring high reliability and/or presenting an extreme operating environment, written consent and authorization from Abracon LLC is required. Please contact Abracon LLC for more information.



5101 Hidden Creek Ln Spicewood TX 78669  
Phone: 512-371-6159 | Fax: 512-351-8858  
For terms and conditions of sales, please visit:  
[www.abracon.com](http://www.abracon.com)

**REVISED: 01-03-20**

ABRACON IS  
ISO9001-2015  
CERTIFIED