

Features

- High Slew Rate30V/ μ s
- Fast Settling330ns
- Wide Power Bandwidth500KHz
- High Gain Bandwidth12MHz
- High Input Impedance50M Ω
- Low Offset Current10nA
- Internally Compensated For Unity Gain Stability

Applications

- Data Acquisition Systems
- R.F. Amplifiers
- Video Amplifiers
- Signal Generators
- Pulse Amplification

Description

HA-2500/2502/2505 comprises a series of monolithic operational amplifiers whose designs are optimized to deliver excellent slew rate, bandwidth, and settling time specifications. The outstanding dynamic features of this internally compensated device are complemented with low offset voltage and offset current.

These dielectrically isolated amplifiers are ideally suited for applications such as data acquisition, R.F., video, and pulse conditioning circuits. Slew rates of $\pm 25V/\mu s$ and 330ns (0.1%) settling time make these devices excellent components in fast, accurate data acquisition and pulse amplification designs. 12MHz small signal bandwidth and 500kHz power bandwidth make these devices well suited to R.F. and video applications. With 2mV typical offset voltage plus offset trim capability and 10nA offset current, HA-2500/2502/2505 are particularly useful components in signal conditioning designs.

The gain and offset voltage figures of the HA-2500 series are optimized by internal component value changes while the similar design of the HA-2510 series is maximized for slew rate.

The HA-2500 and HA-2502 have guaranteed operation from $-55^{\circ}C$ to $+125^{\circ}C$ and are available in hermetic metal can and ceramic miniDIP packages. Both are offered as a /883 military grade part with the HA-2502 also available in LCC package. The HA-2505 has guaranteed operation from $0^{\circ}C$ to $+75^{\circ}C$ and is available in plastic and ceramic miniDIP and metal can packages. Mil-Std-883 product and data sheets are available upon request.

Pinouts

HA7-2500/02/02 (CERAMIC MINI-DIP)
HA3-2505 (PLASTIC MINI-DIP)
TOP VIEW

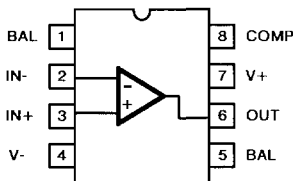

HA2-2500/02/05 (TO-99 METAL CAN)
TOP VIEW

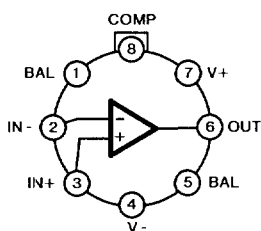

Schematic

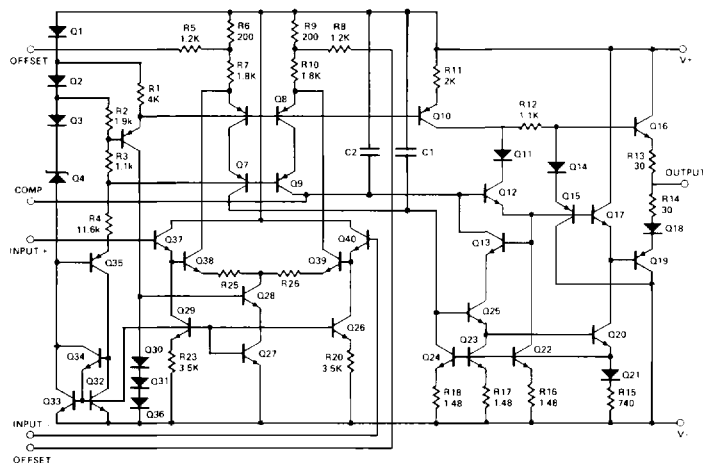

Specifications HA-2500/2502/2505

Absolute Maximum Ratings (Note 6)

Voltage Between V+ and V- Terminals 40.0V	Operating Temperature Range
Differential Input Voltage..... $\pm 15.0V$	HA-2510:2512 $-55^{\circ}C \leq T_A \leq +125^{\circ}C$
Peak Output Current..... 50mA	HA-2515..... $0^{\circ}C \leq T_A \leq +75^{\circ}C$
Internal Power Dissipation 300mW	Storage Temperature Range $-65^{\circ}C \leq T_A \leq +150^{\circ}C$
Lead Solder Temperature (10 Seconds) $+275^{\circ}C$	Maximum Junction Temperature $+175^{\circ}C$

Electrical Specifications V+ = +15V D.C., V- = -15V D.C.

PARAMETER	TEMP.	HA-2500 -55°C to +125°C			HA-2502 -55°C to +125°C			HA-2505 0°C to +75°C			UNITS
		MIN	TYP	MAX	MIN	TYP	MAX	MIN	TYP	MAX	
INPUT CHARACTERISTICS											
Offset Voltage	+25°C		2	5		4	8		4	8	mV
	Full			8			10			10	mV
Offset Voltage Average Drift	Full		20			20			20		$\mu V/^{\circ}C$
Bias Current	+25°C		100	200		125	250		125	250	nA
	Full			400			500			500	nA
Offset Current	+25°C		10	25		20	50		20	50	nA
	Full			50			100			100	nA
Input Resistance (Note 10)	+25°C	25	50		20	50		20	50		M Ω
Common Mode Range	Full	± 10.0			± 10.0			± 10.0			V
TRANSFER CHARACTERISTICS											
Large Signal Voltage Gain (Note 1, 4)	+25°C	20K	30K		15K	25K		15K	25K		V/V
	Full	15K			10K			10K			V/V
Common Mode Rejection Ratio (Note 2)	Full	80	90		74	90		74	90		dB
Gain Bandwidth Product (Note 3)	+25°C		12			12			12		MHz
OUTPUT CHARACTERISTICS											
Output Voltage Swing (Note 1)	Full	± 10.0	± 12.0		± 10.0	± 12.0		± 10.0	± 12.0		V
Output Current (Note 4)	+25°C	± 10	± 20		± 10	± 20		± 10	± 20		mA
Full Power Bandwidth (Notes 4,11)	+25°C	350	500		300	500		300	500		KHz
TRANSIENT RESPONSE											
Rise Time (Notes 1, 5, 7 & 8)	+25°C		25	50		25	50		25	50	ns
Overshoot (Notes 1, 5, 7 & 8)	+25°C		25	40		25	50		25	50	%
Slew Rate (Notes 1, 5, 8 & 12)	+25°C	± 25	± 30		± 20	± 30		± 20	± 30		V/ μs
Settling Time to 0.1% (Notes 1, 5, 8 & 12)	+25°C		0.33			0.33			0.33		μs
POWER SUPPLY CHARACTERISTICS											
Supply Current	+25°C		4	6		4	6		4	6	mA
Power Supply Rejection Ratio (Note 9)	Full	80	90		74	90		74	90		dB

- | | | |
|-------|----------------------|---|
| NOTES | 1 $R_L = 2K\Omega$ | 6 Absolute Maximum Ratings are limiting values, applied individually, beyond which the serviceability of the circuit may be impaired. |
| | 2 $V_{CM} = \pm 10V$ | 7 $V_O = \pm 200mV$ |
| | 3 $A_V = 10$ | 8 See Transient Response Test Circuits and Waveforms |
| | 4 $V_O = \pm 10.0V$ | 9 $\Delta V = \pm 5.0V$ |
| | 5 $C_L = 50pF$ | 10 This parameter value is based on design calculations |
| | | 11 Full Power Bandwidth guaranteed based on slew rate measurement using $FPBW = S.R. / 2 \cdot V_{peak}$ |
| | | 12 $V_{OUT} = \pm 5V$ |

Performance Curves $V_+ = +15\text{VDC}$, $V_- = -15\text{VDC}$, $T_A = +25^\circ\text{C}$, Unless Otherwise Stated

INPUT BIAS AND OFFSET CURRENT vs TEMPERATURE

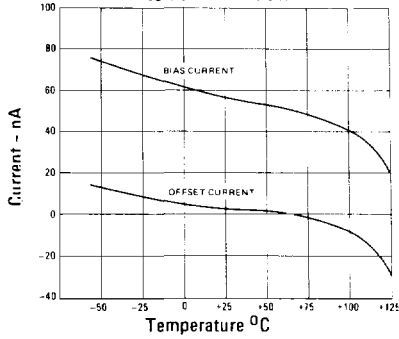

EQUIVALENT INPUT NOISE vs BANDWIDTH

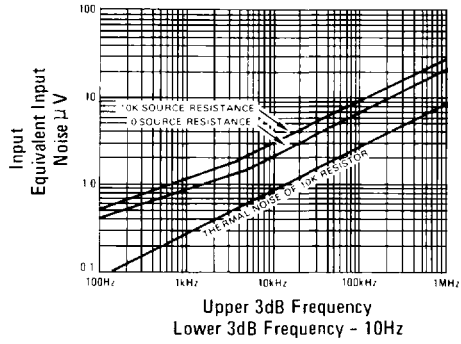

NORMALIZED AC PARAMETERS vs TEMPERATURE

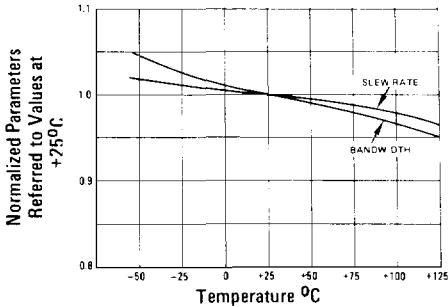

OPEN-LOOP FREQUENCY AND PHASE RESPONSE

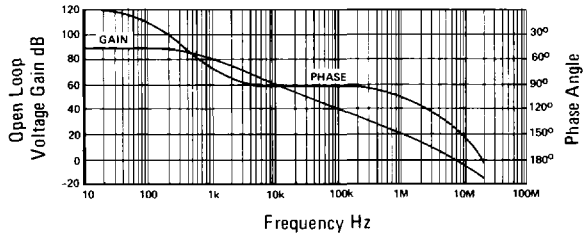

NORMALIZED AC PARAMETERS vs SUPPLY VOLTAGE AT +25 degrees Celsius

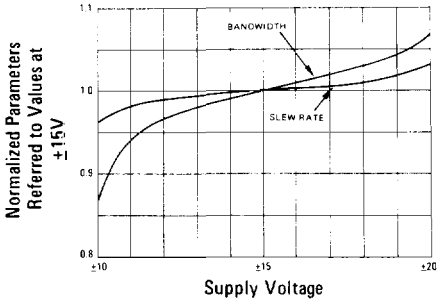

OPEN LOOP FREQUENCY RESPONSE FOR VARIOUS VALUES OF CAPACITORS FROM COMPENSATION PIN TO GROUND

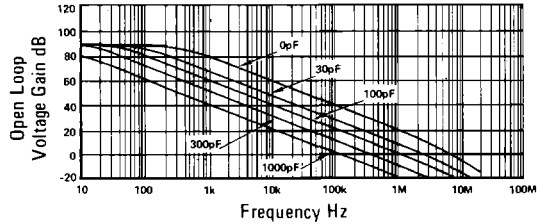

NOTE: External compensation components are not required for stability, but may be added to reduce bandwidth if desired.

OPEN LOOP VOLTAGE GAIN vs TEMPERATURE

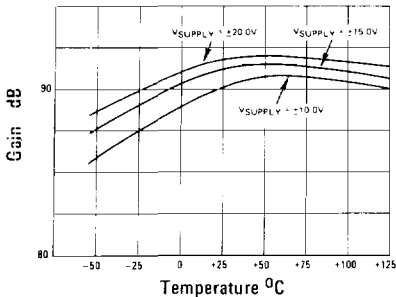

OUTPUT VOLTAGE SWING vs FREQUENCY AT +25 degrees Celsius

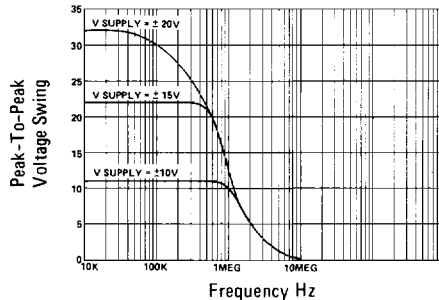

Typical Performance Curves (Continued)
POWER SUPPLY CURRENT
vs TEMPERATURE

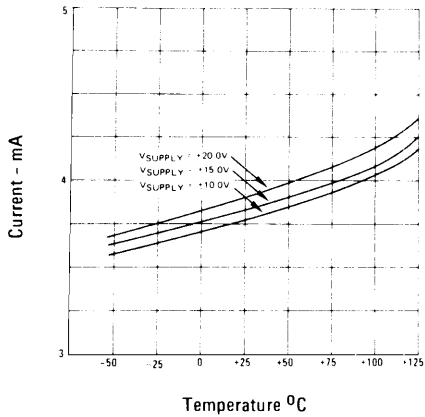

VOLTAGE FOLLOWER PULSE RESPONSE

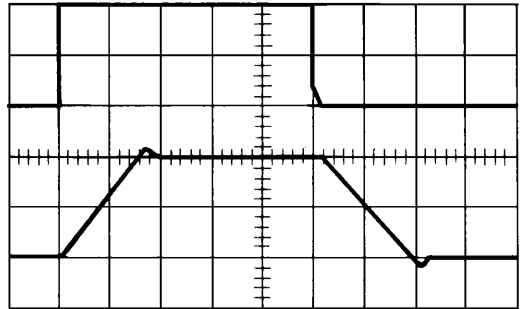

$R_L = 2K\Omega$, $C_L = 50pF$
 Upper Trace: Input
 Lower Trace: Output

Vertical = 5V/Div.
 Horizontal = 200ns/Div.
 $T_A = +25^\circ C$, $V_S = \pm 15.0V$

Test Circuits

SLEW RATE AND
SETTLING TIME

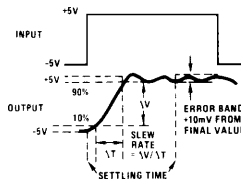

TRANSIENT RESPONSE

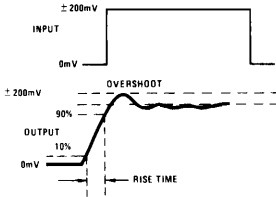

SLEW RATE AND
TRANSIENT RESPONSE

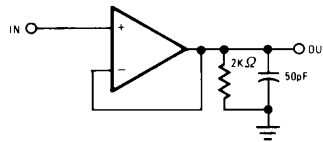

SUGGESTED
VOS ADJUSTMENT

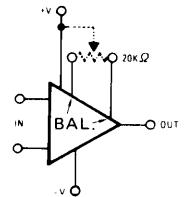

NOTE: Measurement on both positive and negative transitions from 0V to +200mV and 0V to -200mV at the output.

Tested Offset Adjustment Range is $|V_{OS} + 1mV|$ minimum referred to output. Typical ranges is $\pm 6mV$ with $R_T = 20k\Omega$.

Settling Time Circuit

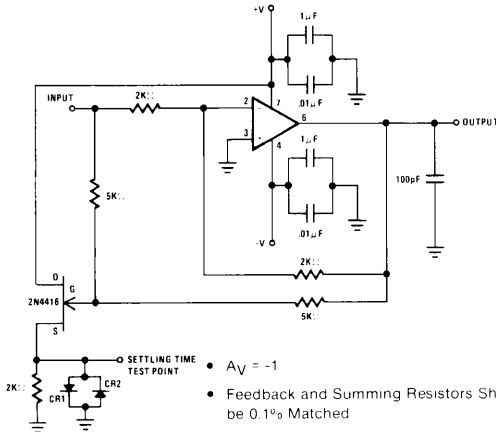

- $A_V = -1$
- Feedback and Summing Resistors Should be 0.1% Matched
- Clipping Diodes CR1 and CR2 are Optional
 HP5082-2810 Recommended

Die Characteristics

Transistor Count	40	
Die Dimensions	57 x 65 x 19 mils	
Substrate Potential	Unbiased	
Process	Bipolar-DI	
Thermal Constants ($^\circ C/W$)	θ_{ja}	θ_{jc}
HA2- Metal Can (-2, -5, -7)	202	56
HA2- Metal Can (-8, /883)	168	52
HA3- Plastic Mini-DIP (-5)	84	34
HA4- Ceramic LCC (/883)	97	35
HA7- Ceramic Mini-DIP (-8, /883)	138	63
HA7- Ceramic Mini-DIP (-2, -5, -7)	204	112