

THESE DRAWINGS ARE THE PROPERTY OF QUALTEK ELECTRONICS AND NOT TO BE REPRODUCED FOR OR COMMUNICATED TO A THIRD PARTY WITHOUT THE EXPRESS WRITTEN PERMISSION OF AN OFFICER OF QUALTEK ELECTRONICS.

REVISION			
REV.	DESCRIPTION	DATE	APPROVED

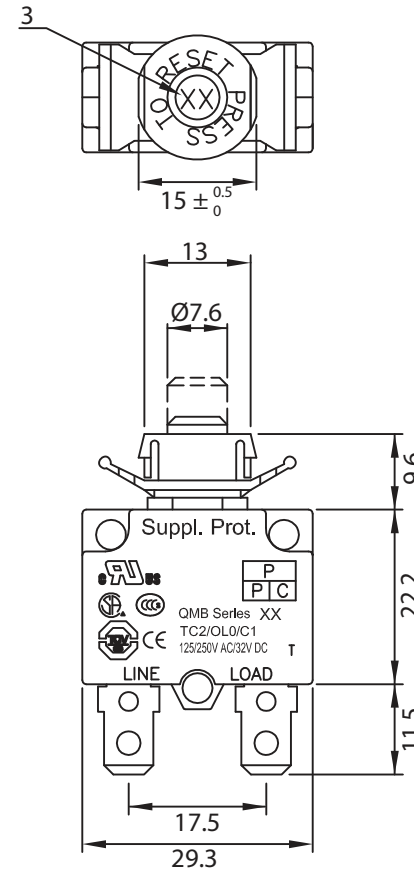
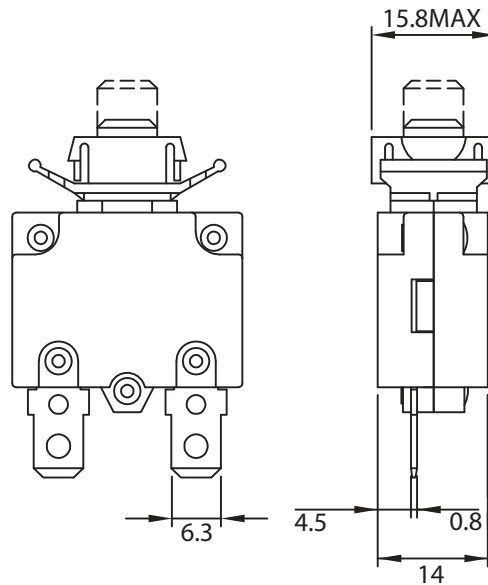
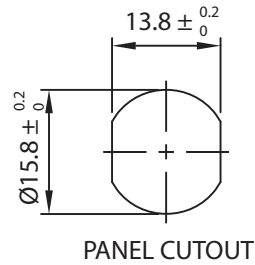

**CONTROLLED**

NOTES:

RATING: 3A 125/250V AC/32V DC  
 PANEL THICKNESS: 0.8mm~2.5mm  
 BUTTON COLOR: BLACK  
 BUTTON PRINT COLOR: WHITE  
 APPROVALS: UL, cUL, TUV, CCC, CE, CSA  
 RoHS COMPLIANT

Dim range (mm)	Tolerance +/- (mm)	Qualtek Electronics Corp. PPC DIVISION		
		Part Number: QMB-033-00ENN-3BA		RoHS Compliant
0-1	0.15	Description: CIRCUIT BREAKER		
1-6	0.20	UNIT: mm		
6-18	0.30	Drawn / Date	Checked / Date	Approved / Date
18-50	0.50			
50-120	0.70	R.Nuti 06-04-14	06-04-15	LY / 06-04-15
120-250	0.90			
250-500	1.20			