



THIS INFORMATION IS CONFIDENTIAL AND PROPRIETARY TO CW INDUSTRIES INCORPORATED AND ITS AFFILIATES. IT MAY NOT BE DISCLOSED TO ANYONE, OTHER THAN CW INDUSTRIES PERSONNEL, WITHOUT WRITTEN AUTHORIZATION FROM CW INDUSTRIES INCORPORATED, SOUTHAMPTON, PENNSYLVANIA USA.

Rating	16(4)A 250V AC   US		<b>Mounting Hole</b> 	<b>Circuit</b> 
	Contact Resistance	50m ohm Max.		
	Insulation Resistance	DC 500V 100M ohm Min.		
	Dielectric Strength	AC 1500V 1 minute		
	Switch Function	4P DPST ON-OFF		
	Operation Temp.	0° C ~ 85° C		

**MATERIAL:**

Frame: Nylon 6/6, Black  
 UL Flame: 94-V0  
 Lever: Metal  
 Terminal: Copper Alloy

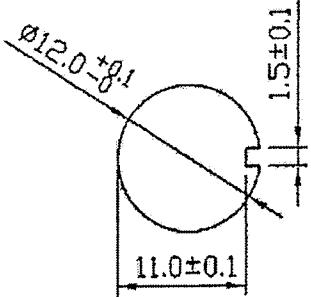
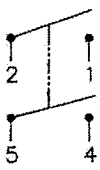
Water proof and Dust Proof  
 to fit IP-56

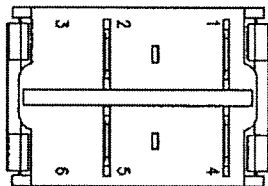
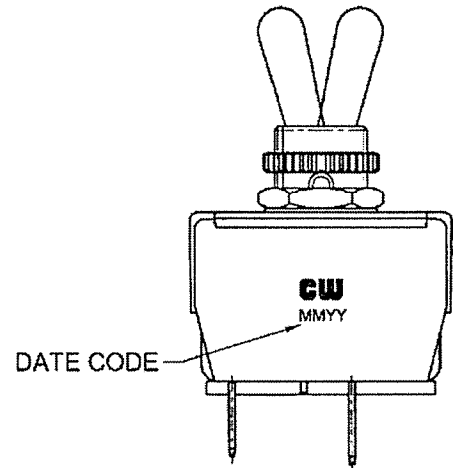
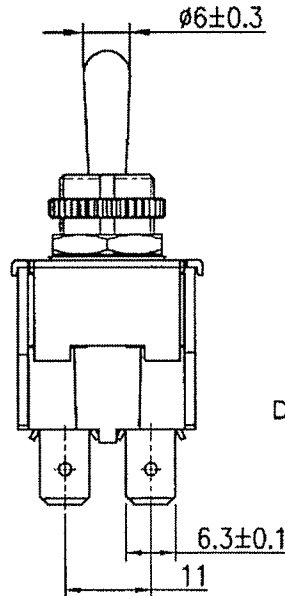
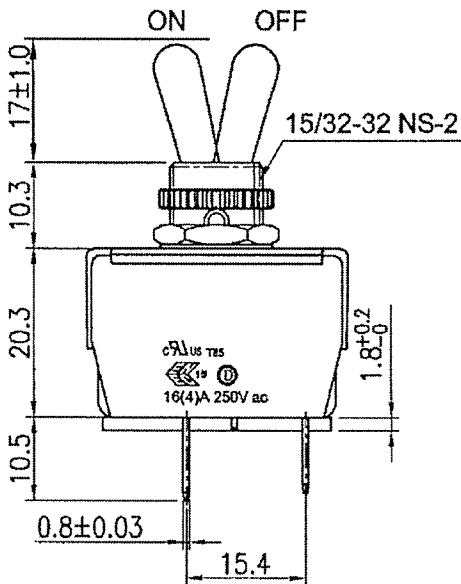
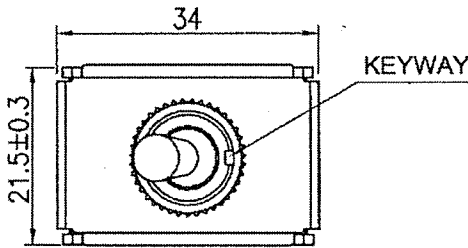

Tolerances Unless Otherwise Specified +/-0.5.

RoHS Compliant

1 Updated material notes.

**CW INDUSTRIES**  
 Southampton, Pa. 18966  
 Tel 215.355.7080/www.cwind.com

Date Drawn: 8/09/12

Rev. 1

Unit: mm

Checked By: *G. Gold*

Title:  
**TOGGLE SWITCH**

CW P/N:  
**GTS448F101AHR**