

REVISIONS

P	LTR	DESCRIPTION	DATE	DWN	APVD
	A	NEW DRAWING	01JUL2019	SR	AP
	BA	DRAWING SCHEDULE ADDED	15FEB2023	DM	AP

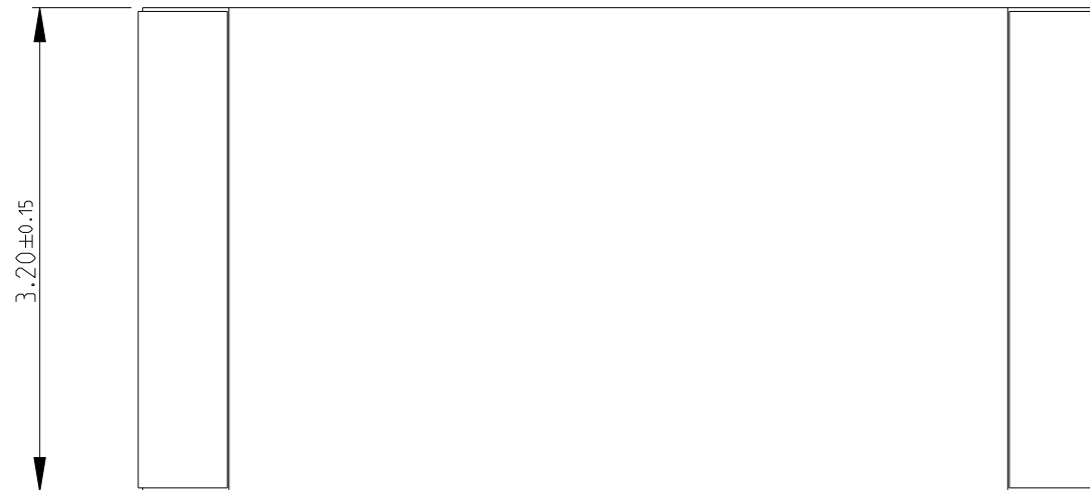

NOTES:

- FOR FURTHER INFORMATION SEE DATA SHEET FOR CRGS SERIES SMD ANTI-SURGE THICK FILM CHIP RESISTOR

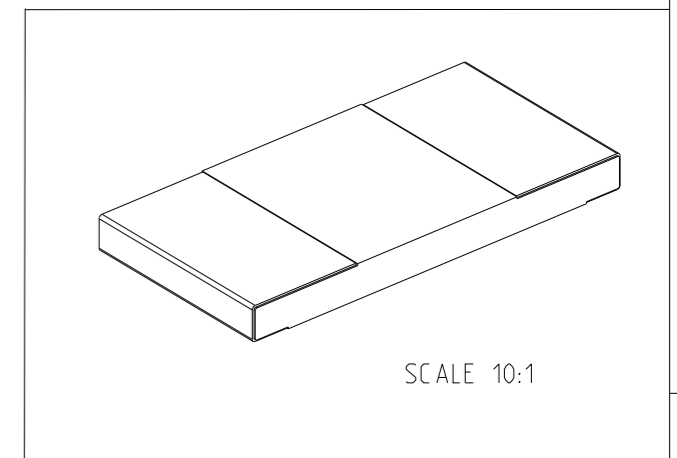
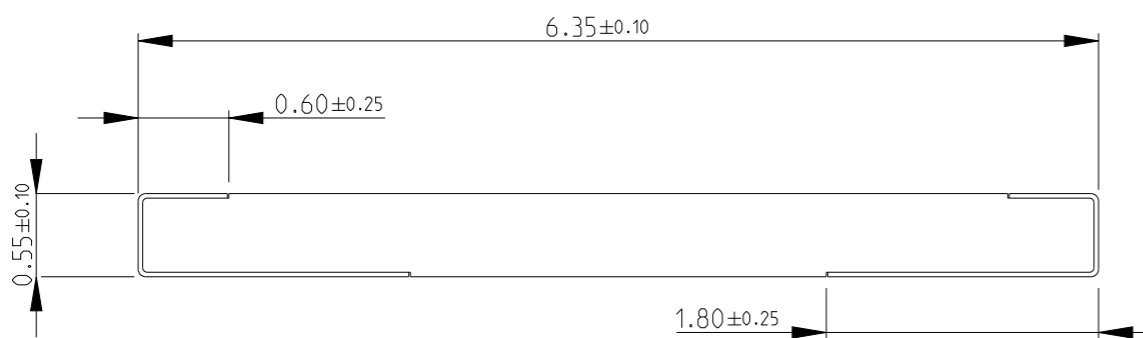

RoHS Compliant

SCALE 10:1

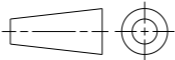
THIS DRAWING IS A CONTROLLED DOCUMENT.		DWN	01JUL2019		 TE Connectivity
		CHK	01JUL2019		
		APVD	01JUL2019		
DIMENSIONS: mm		TOLERANCES UNLESS OTHERWISE SPECIFIED:		NAME	
		0 PLC ±0.5 1 PLC ±0.2 2 PLC ±0.1 3 PLC ± 4 PLC ± ANGLES ±°		SMD ANTI-SURGE THICK FILM RESISTOR TYPE CRGS 2512 SERIES	
MATERIAL		FINISH		PRODUCT SPEC	
-		-		-	
				APPLICATION SPEC	
				-	
				WEIGHT	
				-	
CUSTOMER DRAWING				SIZE	RESTRICTED TO
				A3	-
				CAGE CODE	
				00779	
				DRAWING NO	
				©=2176246	
				SCALE	
				20:1	
				SHEET	
				1 OF 3	
				REV	
				BA	

REVISIONS

P	LTR	DESCRIPTION	DATE	DWN	APVD
	-	SEE SHEET 1	-	-	-

SCHEDULE

TCPN	CATALOGUE NUMBER	PART DESCRIPTION	PART STATUS
2176246-1	CRGS2512J1R0	CRGS2512 5% 1R0	PRODUCTION
2176246-2	CRGS2512J1R2	CRGS2512 5% 1R2	PRODUCTION
2176246-3	CRGS2512J1R5	CRGS2512 5% 1R5	PRODUCTION
2176246-4	CRGS2512J1R8	CRGS2512 5% 1R8	PRODUCTION
2176246-5	CRGS2512J2R2	CRGS2512 5% 2R2	PRODUCTION
2176246-6	CRGS2512J2R7	CRGS2512 5% 2R7	PRODUCTION
2176246-7	CRGS2512J3R3	CRGS2512 5% 3R3	PRODUCTION
2176246-8	CRGS2512J3R9	CRGS2512 5% 3R9	PRODUCTION
2176246-9	CRGS2512J4R7	CRGS2512 5% 4R7	PRODUCTION
1-2176246-0	CRGS2512J5R6	CRGS2512 5% 5R6	PRODUCTION
1-2176246-1	CRGS2512J6R8	CRGS2512 5% 6R8	PRODUCTION
1-2176246-2	CRGS2512J8R2	CRGS2512 5% 8R2	PRODUCTION
1-2176246-3	CRGS2512J10R	CRGS2512 5% 10R	PRODUCTION
1-2176246-4	CRGS2512J12R	CRGS2512 5% 12R	PRODUCTION
1-2176246-5	CRGS2512J15R	CRGS2512 5% 15R	PRODUCTION
1-2176246-6	CRGS2512J18R	CRGS2512 5% 18R	PRODUCTION
1-2176246-7	CRGS2512J22R	CRGS2512 5% 22R	PRODUCTION
1-2176246-8	CRGS2512J27R	CRGS2512 5% 27R	PRODUCTION
1-2176246-9	CRGS2512J33R	CRGS2512 5% 33R	PRODUCTION
2-2176246-0	CRGS2512J39R	CRGS2512 5% 39R	PRODUCTION
2-2176246-1	CRGS2512J47R	CRGS2512 5% 47R	PRODUCTION
2-2176246-2	CRGS2512J56R	CRGS2512 5% 56R	PRODUCTION
2-2176246-3	CRGS2512J68R	CRGS2512 5% 68R	PRODUCTION
2-2176246-4	CRGS2512J82R	CRGS2512 5% 82R	PRODUCTION
2-2176246-5	CRGS2512J100R	CRGS2512 5% 100R	PRODUCTION
2-2176246-6	CRGS2512J120R	CRGS2512 5% 120R	PRODUCTION
2-2176246-7	CRGS2512J150R	CRGS2512 5% 150R	PRODUCTION
2-2176246-8	CRGS2512J180R	CRGS2512 5% 180R	PRODUCTION
2-2176246-9	CRGS2512J220R	CRGS2512 5% 220R	PRODUCTION
3-2176246-0	CRGS2512J270R	CRGS2512 5% 270R	PRODUCTION

SCHEDULE

TCPN	CATALOGUE NUMBER	PART DESCRIPTION	PART STATUS
3-2176246-1	CRGS2512J330R	CRGS2512 5% 330R	PRODUCTION
3-2176246-2	CRGS2512J390R	CRGS2512 5% 390R	PRODUCTION
3-2176246-3	CRGS2512J470R	CRGS2512 5% 470R	PRODUCTION
3-2176246-4	CRGS2512J560R	CRGS2512 5% 560R	PRODUCTION
3-2176246-5	CRGS2512J680R	CRGS2512 5% 680R	PRODUCTION
3-2176246-6	CRGS2512J820R	CRGS2512 5% 820R	PRODUCTION
3-2176246-7	CRGS2512J1K0	CRGS2512 5% 1K0	PRODUCTION
3-2176246-8	CRGS2512J1K2	CRGS2512 5% 1K2	PRODUCTION
3-2176246-9	CRGS2512J1K5	CRGS2512 5% 1K5	PRODUCTION
4-2176246-0	CRGS2512J1K8	CRGS2512 5% 1K8	PRODUCTION
4-2176246-1	CRGS2512J2K2	CRGS2512 5% 2K2	PRODUCTION
4-2176246-2	CRGS2512J2K7	CRGS2512 5% 2K7	PRODUCTION
4-2176246-3	CRGS2512J3K3	CRGS2512 5% 3K3	PRODUCTION
4-2176246-4	CRGS2512J3K9	CRGS2512 5% 3K9	PRODUCTION
4-2176246-5	CRGS2512J4K7	CRGS2512 5% 4K7	PRODUCTION
4-2176246-6	CRGS2512J5K6	CRGS2512 5% 5K6	PRODUCTION
4-2176246-7	CRGS2512J6K8	CRGS2512 5% 6K8	PRODUCTION
4-2176246-8	CRGS2512J8K2	CRGS2512 5% 8K2	PRODUCTION
4-2176246-9	CRGS2512J10K	CRGS2512 5% 10K	PRODUCTION
5-2176246-0	CRGS2512J12K	CRGS2512 5% 12K	PRODUCTION
5-2176246-1	CRGS2512J15K	CRGS2512 5% 15K	PRODUCTION
5-2176246-2	CRGS2512J18K	CRGS2512 5% 18K	PRODUCTION
5-2176246-3	CRGS2512J22K	CRGS2512 5% 22K	PRODUCTION
5-2176246-4	CRGS2512J27K	CRGS2512 5% 27K	PRODUCTION
5-2176246-5	CRGS2512J33K	CRGS2512 5% 33K	PRODUCTION
5-2176246-6	CRGS2512J39K	CRGS2512 5% 39K	PRODUCTION
5-2176246-7	CRGS2512J47K	CRGS2512 5% 47K	PRODUCTION
5-2176246-8	CRGS2512J56K	CRGS2512 5% 56K	PRODUCTION
5-2176246-9	CRGS2512J68K	CRGS2512 5% 68K	PRODUCTION
6-2176246-0	CRGS2512J82K	CRGS2512 5% 82K	PRODUCTION

THIS DRAWING IS A CONTROLLED DOCUMENT.

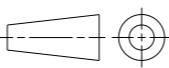
DIMENSIONS: mm	TOLERANCES UNLESS OTHERWISE SPECIFIED:
	0 PLC ±0.5 1 PLC ±0.2 2 PLC ±0.1 3 PLC ± 4 PLC ± ANGLES ±5°
MATERIAL	FINISH
-	-

DWN	01JUL2019
SUPREETH R	
CHK	01JUL2019
ALLAN.P	
APVD	01JUL2019
ALLAN.P	
PRODUCT SPEC	
-	
APPLICATION SPEC	
-	
WEIGHT	-
CUSTOMER DRAWING	



NAME
SMD ANTI-SURGE THICK FILM RESISTOR TYPE CRGS 2512 SERIES

SIZE	CAGE CODE	DRAWING NO	RESTRICTED TO
A3	00779	©=2176246	-
SCALE	SHEET	OF	REV
20:1	2	3	BA

REVISIONS

P	LTR	DESCRIPTION	DATE	DWN	APVD
-		SEE SHEET 1	-	-	-

SCHEDULE

TCPN	CATALOGUE NUMBER	PART DESCRIPTION	PART STATUS
6-2176246-1	CRGS2512J100K	CRGS2512 5% 100K	PRODUCTION
6-2176246-2	CRGS2512J120K	CRGS2512 5% 120K	PRODUCTION
6-2176246-3	CRGS2512J150K	CRGS2512 5% 150K	PRODUCTION
6-2176246-4	CRGS2512J180K	CRGS2512 5% 180K	PRODUCTION
6-2176246-5	CRGS2512J220K	CRGS2512 5% 220K	PRODUCTION
6-2176246-6	CRGS2512J270K	CRGS2512 5% 270K	PRODUCTION
6-2176246-7	CRGS2512J330K	CRGS2512 5% 330K	PRODUCTION
6-2176246-8	CRGS2512J390K	CRGS2512 5% 390K	PRODUCTION
6-2176246-9	CRGS2512J470K	CRGS2512 5% 470K	PRODUCTION
7-2176246-0	CRGS2512J560K	CRGS2512 5% 560K	PRODUCTION
7-2176246-1	CRGS2512J680K	CRGS2512 5% 680K	PRODUCTION
7-2176246-2	CRGS2512J820K	CRGS2512 5% 820K	PRODUCTION
7-2176246-3	CRGS2512J1M0	CRGS2512 5% 1M0	PRODUCTION
7-2176246-4	CRGS2512J1M2	CRGS2512 5% 1M2	PRODUCTION
7-2176246-5	CRGS2512J1M5	CRGS2512 5% 1M5	PRODUCTION
7-2176246-6	CRGS2512J1M8	CRGS2512 5% 1M8	PRODUCTION
7-2176246-7	CRGS2512J2M2	CRGS2512 5% 2M2	PRODUCTION
7-2176246-8	CRGS2512J2M7	CRGS2512 5% 2M7	PRODUCTION
7-2176246-9	CRGS2512J3M3	CRGS2512 5% 3M3	PRODUCTION
8-2176246-0	CRGS2512J3M9	CRGS2512 5% 3M9	PRODUCTION
8-2176246-1	CRGS2512J4M7	CRGS2512 5% 4M7	PRODUCTION
8-2176246-2	CRGS2512J5M6	CRGS2512 5% 5M6	PRODUCTION
8-2176246-3	CRGS2512J6M8	CRGS2512 5% 6M8	PRODUCTION
8-2176246-4	CRGS2512J8M2	CRGS2512 5% 8M2	PRODUCTION
8-2176246-5	CRGS2512J10M	CRGS2512 5% 10M	PRODUCTION
8-2176246-6	CRGS2512J300R	CRGS2512 5% 300R	PRODUCTION
8-2176246-7	CRGS2512J9K1	CRGS2512 5% 9K1	PRODUCTION

THIS DRAWING IS A CONTROLLED DOCUMENT.

DIMENSIONS:
mm

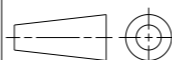

MATERIAL

TOLERANCES UNLESS OTHERWISE SPECIFIED:

- 0 PLC ±0.5
- 1 PLC ±0.2
- 2 PLC ±0.1
- 3 PLC ±
- 4 PLC ±
- ANGLES ±°
- FINISH

DWN SUPREETH R 01JUL2019

CHK ALLAN.P 01JUL2019

APVD ALLAN.P 01JUL2019

PRODUCT SPEC

APPLICATION SPEC

WEIGHT

CUSTOMER DRAWING



TE Connectivity

NAME
SMD ANTI-SURGE THICK FILM
RESISTOR TYPE CRGS 2512 SERIES

SIZE CAGE CODE DRAWING NO RESTRICTED TO

A3 00779 C-2176246

SCALE 20:1 SHEET 3 OF 3 REV BA