

ISL59605-SPI-EVALZ

Evaluation Board (with Serial Interface) Operation (Rev 1.0 to 4.0)

AN1588  
Rev 3.00  
Aug 29, 2012

**Description**

The ISL59605-SPI-EVALZ board is designed to allow evaluation of the ISL5960x (MegaQ™) family of parts, as well as provide the reference schematic and PCB layout of a MegaQ™ implementation on a 4-layer PCB. In addition to the MegaQ™ equalization path, the board features a USB interface that allows access to and control of MegaQ™ internal configuration registers, enabling a few more features than are available when using the stand-alone configuration (see the [ISL59605](#) datasheet for more details). *This Application Note is for revisions 1.0 to 4.0 of the ISL59605-SPI-EVALZ board. For revision 5.0 of the evaluation board, see [AN1775](#). The board revision number is found in the top right corner on the top side of the board.*

**Initial Set-Up**

This application note first describes how to set-up and use this evaluation board in a stand-alone configuration, then explains how to install the software and use the Windows GUI to read and write MegaQ™ internal registers.

**Power Connections**

The power pins are located on the lower left of the evaluation board (see Figure 1). The board requires a 5V power supply capable of supplying at least 150mA. Because of the high amount of high-frequency gain required to equalize long cables, excessive noise on the power supply may introduce noise on the output signal or cause difficulty locking at longer distances. Power supplies with linear regulators are preferable to switching regulators, however, switching supplies may work acceptably well if they are adequately filtered.

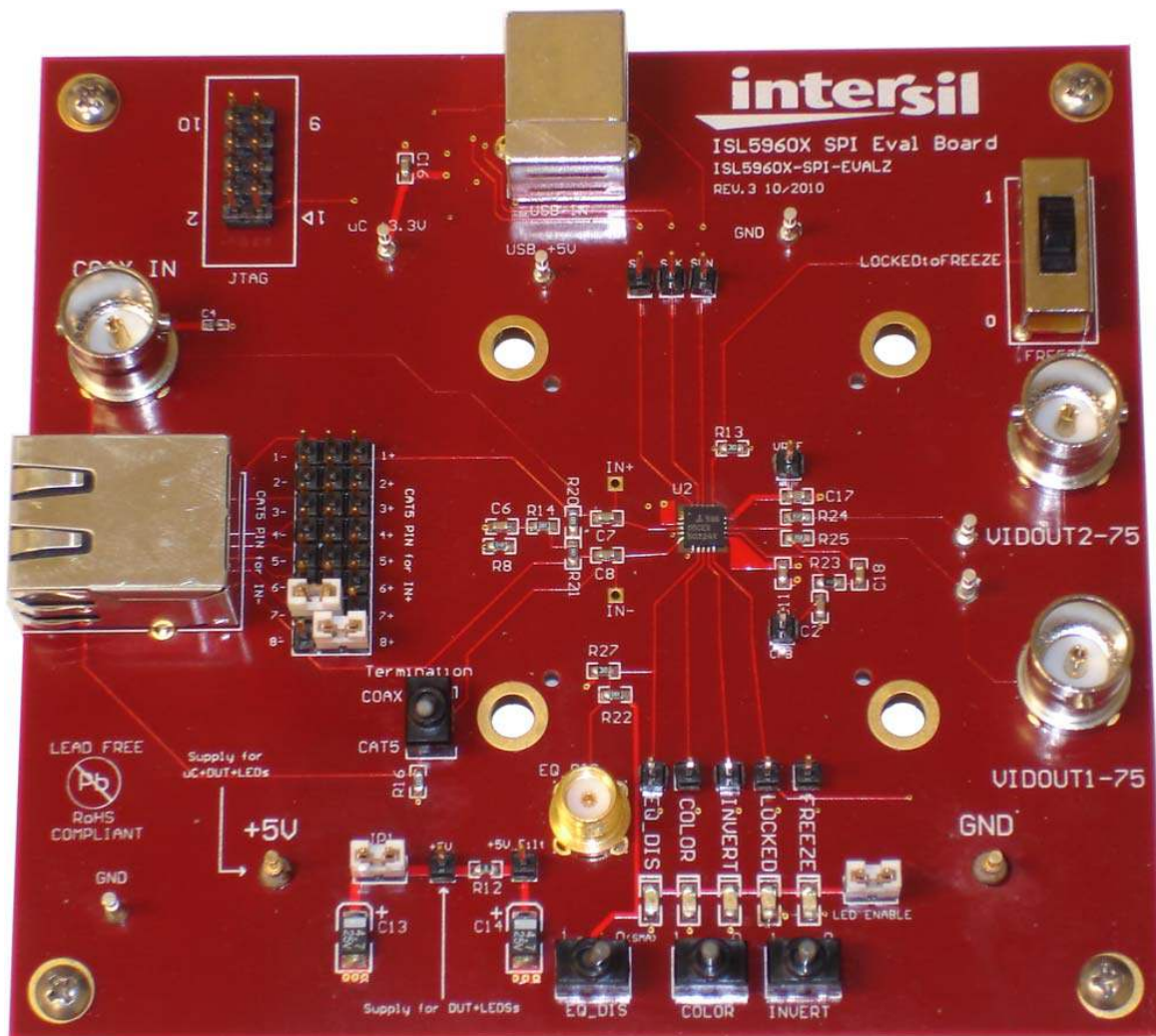

## Jumpers

There are several jumpers that need to be configured for proper operation of the evaluation board. JP1 is located just to the right of the +5V power connection. It needs to be in place for power to get to MegaQ™ and the LEDs. The jumper may be removed and replaced with an ammeter to measure the current consumed by MegaQ™ and (optionally) the LEDs. **JP1 must be shorted (either with a jumper or an ammeter) for the evaluation board to function!**

The LED Enable jumper selects whether the LEDs are grounded (i.e. will light-up when a MegaQ™ output goes high) or floating (will not light-up or consume current). To measure MegaQ™ current without the LEDs, remove the LED Enable jumper.

The large 3x8 header block is described in the next section.

The JTAG header on the upper left is used to program the microcontroller during production and is not used when operating the evaluation board. Do not connect anything to the JTAG header.

## Input Connections

Unshielded twisted pair (UTP) signals arrive via the RJ-45 connector on the left. The input signal can arrive on any arbitrary combination of pins, though it should usually be one of the standard Cat x pairs of 1 and 2, 3 and 6, 4 and 5, or 7 and 8. The

3x8 header block to the right of the RJ-45 jack is used to assign which Cat x pin goes to the positive MegaQ™ input (in Figure 1, pin 8), and which goes to the negative input (pin 7). The “Termination” switch to the lower right of the jumper block should be switched to “CAT5” (as shown in Figure 1). Do not attach a coax cable while trying to receive a signal over Cat x.

Coax signals are connected through the “COAX IN” BNC connector on the upper left. When using coax signals, set the “Termination” switch to “COAX” and ensure that no Cat x cables are attached to the RJ45 connector.

The IN+ and IN- test points near U1 can be used to view the input signals at the input to the MegaQ™ chip.

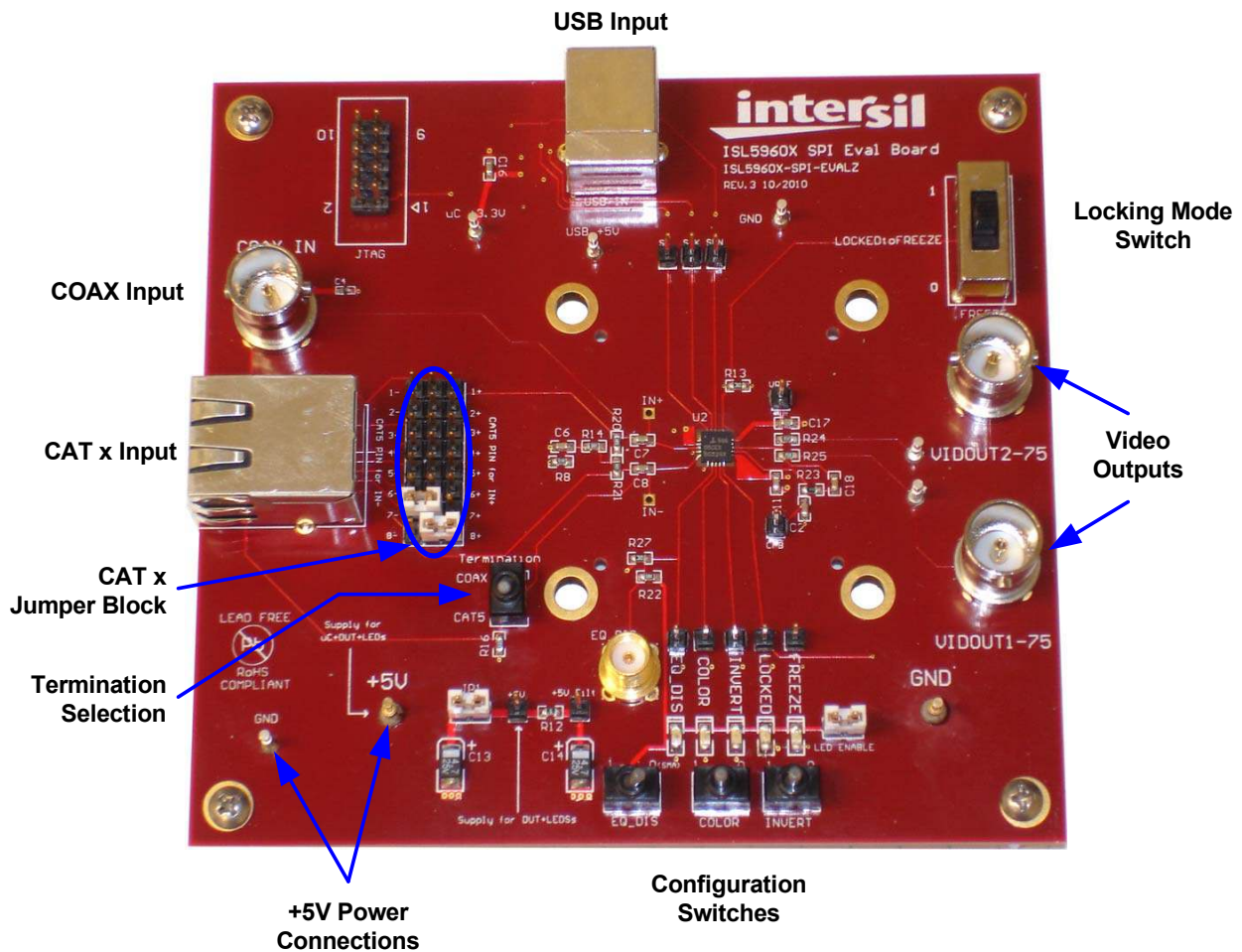

FIGURE 1. EXTERNAL CONNECTIONS AND SWITCHES

## Output Connections

Standard 75Ω composite video is available at the “VIDOUT1-75” and “VIDOUT2-75” BNC connectors on the right, as well as the 2 test pins between R24/R25 and the BNC outputs.

## Switch Settings

There are several switches on the evaluation board that can be used to put MegaQ™ in its different operational modes. Figure 1 shows all the switches in their recommended positions for stand-alone operation:

- **“EQ\_DIS” (EQ Disable):** This can be used to disable the EQ so an external source can drive a signal over the cable. This switch should be set to the “0” position for normal operation. To drive EQ Disable with a high frequency logic signal, put the “EQ\_DIS” switch into the “0” position (terminating the signal into 50Ω) and apply the signal to the SMB connector above the “EQ\_DIS” switch. Note: The switch used may have a middle “open” position, but it should always be set low or high.
- **COLOR:** The Color signal can be an input or an output (see datasheet for more information). The default position for automatic color detection is the middle position (“F” for floating, i.e. not 0 or 1).
- **INVERT:** The Invert signal can be an input or an output (see datasheet for more info). The default position for automatic inversion detection and correction is the middle position (“F” for floating, i.e. not 0 or 1).
- **FREEZE:** The “FREEZE” switch determines the operational mode. The recommended mode for stand-alone operation is “Lock Until Reset”, which is the middle (“LOCKEDtoFREEZE”) position. To put MegaQ™ in the Continuous Update mode, slide the switch down to the “0” position. The “0” position should also be used when you are controlling MegaQ™ through the serial interface. The “1” position freezes the equalizer in its current state. See the datasheet for more detailed information on the locking modes.

## LEDs

There are 5 LEDs at the bottom of the board that indicate the current state of the EQ\_DIS, COLOR, INVERT, LOCKED, and FREEZE signals, as well as test pins for that signal directly above. The LEDs are only enabled when the LED ENABLE jumper is in place. When the LEDs are illuminated, they will draw additional supply current from the 5V supply. To accurately measure the supply current of the ISL5960x without including any LED current, remove the LED ENABLE jumper to disable the LEDs and place an ammeter in place of the JP1 jumper to measure the supply current to MegaQ™ only.

## Software Installation

The next section explains how to install the GUI (Graphical User Interface) software, configure the hardware for software control, attach the board to the PC via USB, and use the GUI to control MegaQ™.

### Notes

This software was developed on and will work 32-bit Windows XP. It *may* also work on some 32-bit Windows 7 platforms. **The USB driver used is not compatible with any 64-bit version of Windows.**

The software is called “ISL59605 Evaluation Software”, but it is designed to work with the entire MegaQ™ family: from the ISL59601 through the ISL59605. Some features supported by the software, such as longer equalization lengths and the noise filtering option in register 0x05, are only available on some versions of MegaQ™.

This documentation contains screen captures of the software at the time this manual was written. Subsequent software versions may appear different.

### Software Installation

The ISL59605-SPI-EVALZ software may be installed from a CD-ROM accompanying the hardware or from an installer file downloaded from the Intersil web site.

Launch the "ISL59605\_Installer.exe" file and follow the instructions. The default installation will add an "Intersil" directory to the "Start Menu/Programs" tree. That directory will contain a shortcut to the ISL59605 executable and an uninstaller.

The default install option installs the main program files in the C:\Program Files\Intersil\ISL59605 directory, however the location can be customized if desired. The USB driver file “windrvr6.sys” will be placed into the C:\WINDOWS\system32\drivers directory, and “usb\_interface.inf” will be installed in C:\WINDOWS\INF.

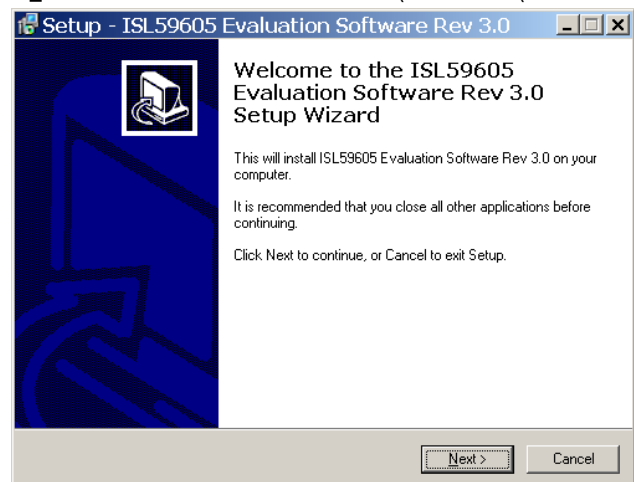
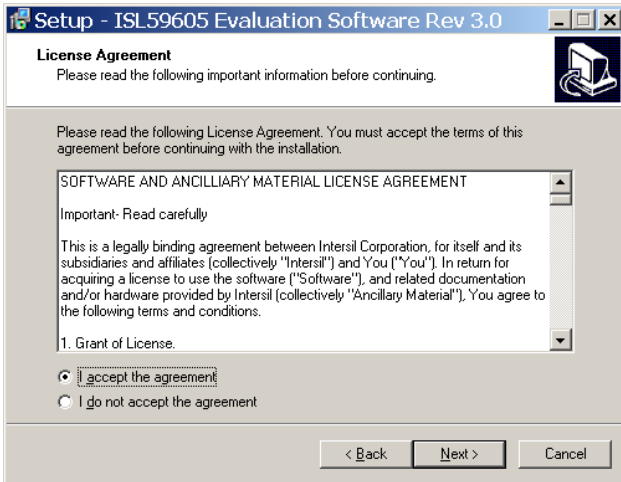

FIGURE 2. INSTALLER WINDOW



Press **Next** to continue to the license agreement.



**FIGURE 3. LICENSE AGREEMENT**

Read the license agreement, choose to accept (or not accept) the license agreement, then click **Next**.

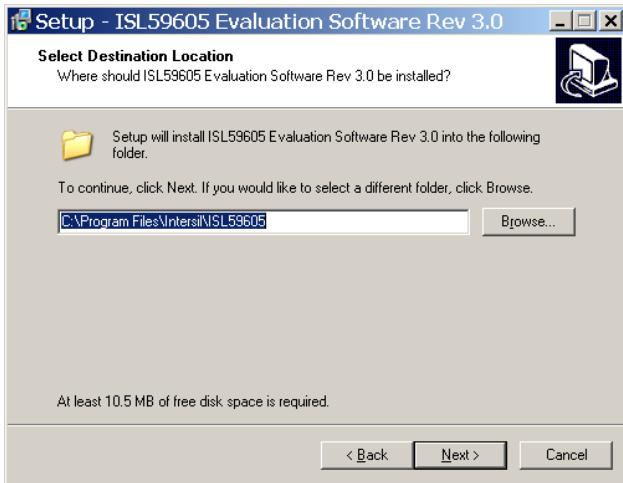

**FIGURE 4. INSTALLATION DIRECTORY**

By default, the installer will put the evaluation software under **C:\Program Files\Intersil\ISL59605** directory. To use a different directory, select the **Browse** button. Press **Next** to continue to the Start Menu Folder screen.

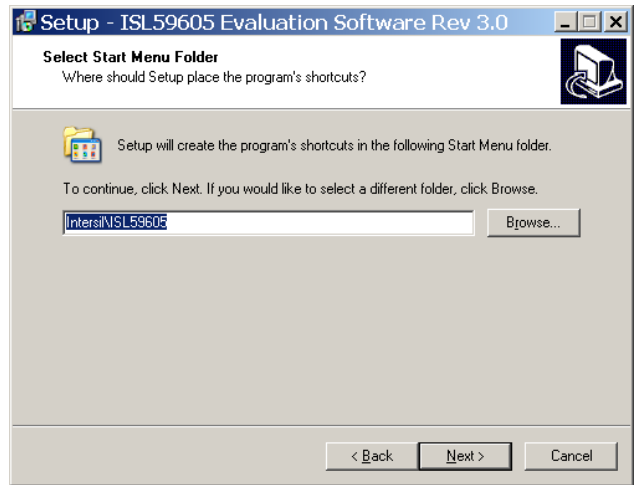

**FIGURE 5. START MENU FOLDER**

Press **Next** to create the Intersil folder in the Start Menu. Press

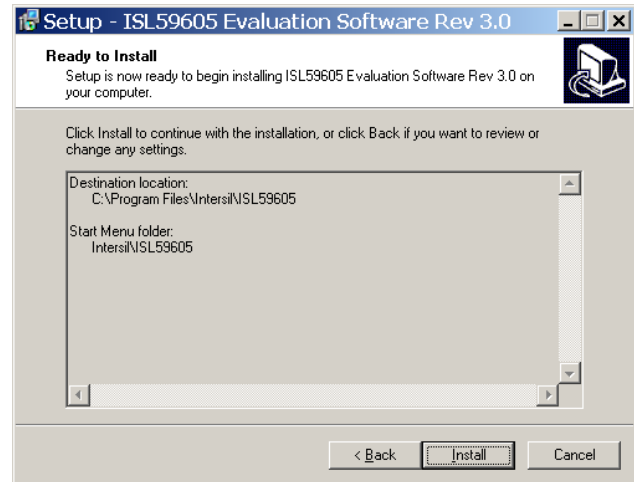

**FIGURE 6. BEGIN INSTALLATION**

Install to copy all the necessary files onto the PC.

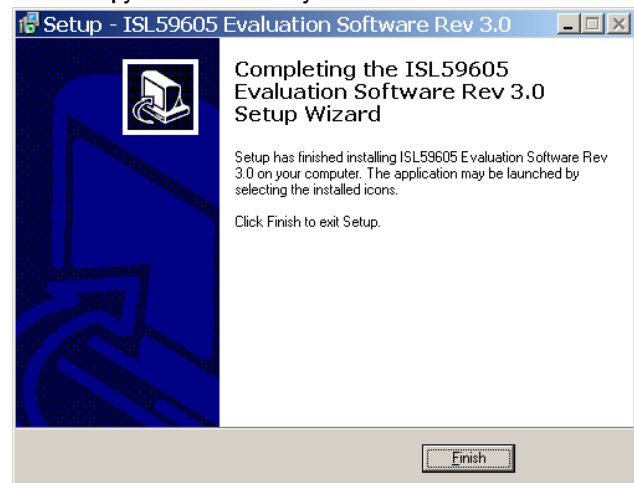

**FIGURE 7. COMPLETION SCREEN**

Click **Finish** to complete installation. Re-boot the PC if requested.

## Hardware Setup

After the software and USB drivers have been installed, the evaluation board must be configured and powered for its initial connection to the PC.

1. Verify that all the switches are in the correct position as described in "Switch Settings" on page 3, except for the FREEZE switch. Set the FREEZE switch to the "0" position to enable software control of the ISL5960x.
2. Verify that JP1 is shorted (either with a jumper or an ammeter) so power will be applied to the IC.
3. Apply power to the +5V and GND posts.
4. Connect the evaluation board to the PC with a USB cable.

## USB Driver Installation

When the evaluation board is initially connected to the PC, Windows XP may display this window:



FIGURE 8. FOUND NEW HARDWARE

If this box appears, select "No, not this time", then click **Next**, causing this screen to appear:



FIGURE 9. SOFTWARE SOURCE SELECTION

Verify that "Install the software automatically" is selected and press **Next**.

The Hardware Wizard will automatically locate and install the driver for the ISL59605:

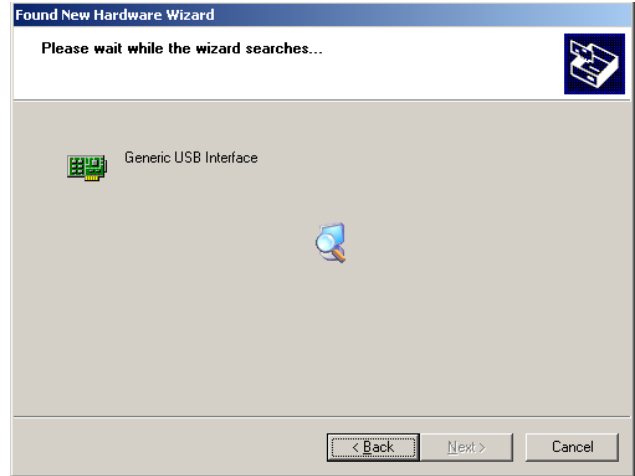

FIGURE 10. FINDING DRIVER

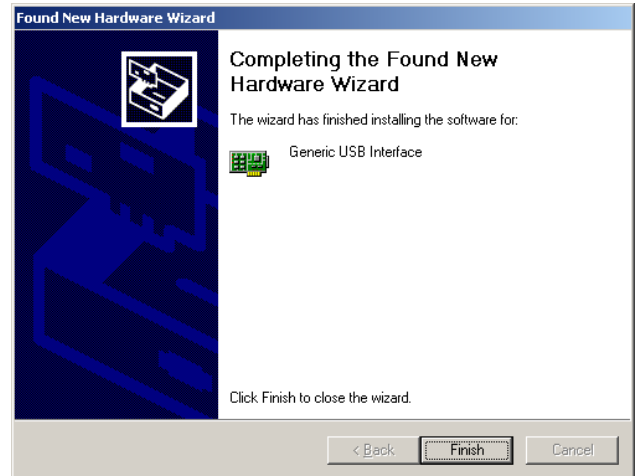

FIGURE 11. DRIVER IS INSTALLED

Click **Finish** to complete the installation.

On XP systems, a pop-up message may appear displaying the status of the ISL59605 hardware:

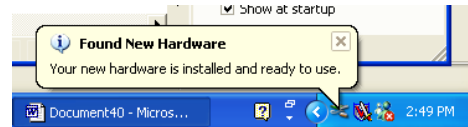

FIGURE 12. HARDWARE INSTALLED NOTIFICATION

## Using the Software

Launch the software (the default location is Start Menu/Programs/Intersil/ISL59605).

After the program has launched, you should see the following screen:

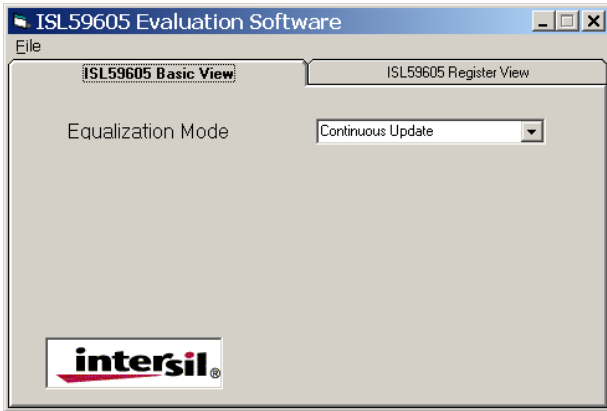

FIGURE 13. BASIC VIEW

### ISL59605 Basic View

Basic View is a simple interface for controlling the Equalization Mode.

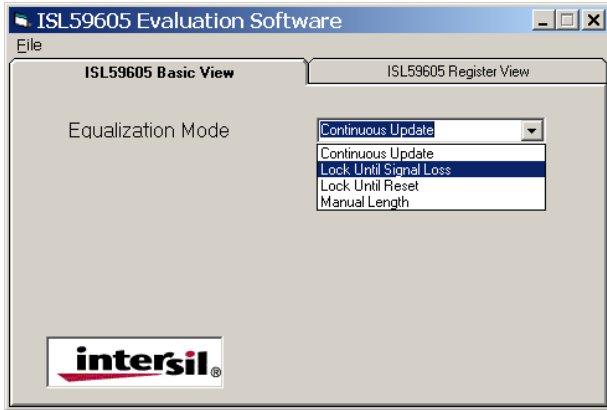

FIGURE 14. EQUALIZATION MODE SELECTION

Using this tab, the user can select between the four equalization modes. The first three modes are various forms of automatic equalization, the last is manual length control (not a particularly useful feature, since the auto EQ almost always equalizes as well as or better than manual, but it may be of some experimental interest):

1. Continuous Update (also available in stand-alone)
2. Lock until Signal Loss
3. Lock until Reset (also available in stand-alone)
4. Manual Length

When the "Manual Length" mode is selected, the slider becomes active and the equalization may be manually adjusted to match the length of cable. In manual mode, the Cable Type also needs to be set. The length control is calibrated for Cat 5/6 cable, not coax. Length settings longer than the part is capable of (e.g. 4000 feet with an ISL59601) will have no effect - a part can not equalize farther than the distance it is designed to go.

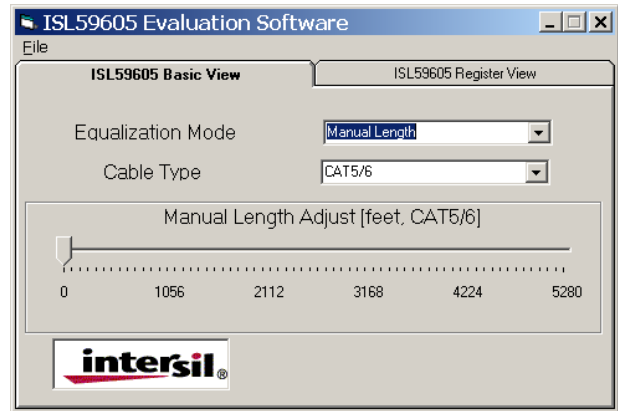

FIGURE 15. BASIC VIEW OPTIONS FOR MANUAL MODE

## ISL59605 Register View

This tab allows user to directly see and modify the contents of the MegaQ™ registers. To update the register contents, click **Read All Registers**.

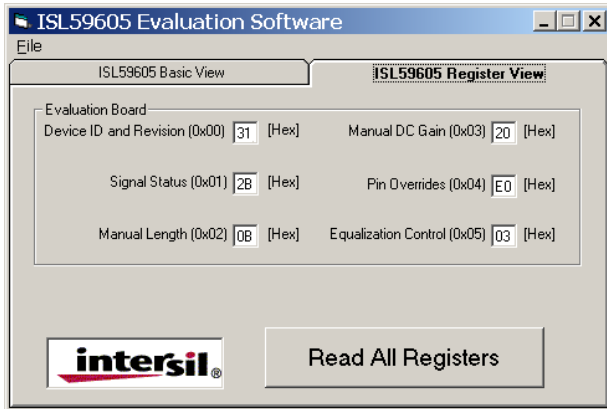

FIGURE 16. REGISTER VIEW

To change a register value, simply type the desired hexadecimal number into the appropriate box. To change both digits of the 2-digit hex number, select both digits with the mouse or by double-clicking inside the text box (03), then quickly type both digits of the desired value. If you type too slowly (more than ~1 second between the first and second digit), the first digit typed will become the lower nibble, and the higher nibble will be 0. To change one nibble using the keyboard, select the high nibble (03) or the low nibble (03) and type the new hexadecimal value. It is not necessary to press the Enter button; the software will automatically send the new value to the ISL59605-SPI-EVALZ Evaluation board.

You can also increment and decrement the register values using the keyboard:

- Up Arrow Key: Increment by 1
- Down Arrow Key: Decrement by 1
- Page Up Key: Increment by 16 (increment high nibble by 1)
- Page Down Key: Decrement by 16 (decrement high nibble by 1)

## ISL59605 Detailed Register View

Right-clicking on any register label brings up a detailed bit-level description of each register. If the register has individual bit functions, they will come up as check boxes that can be checked or unchecked.

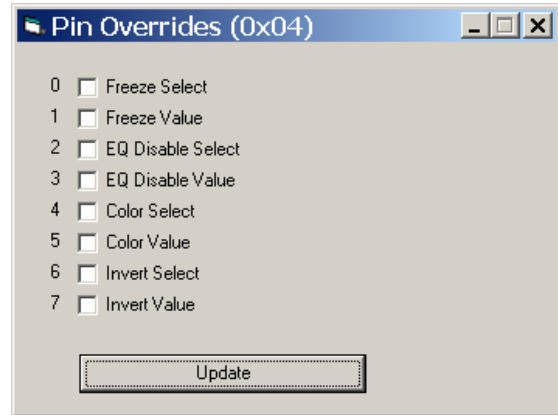

FIGURE 17. PIN OVERRIDE

If the register has grouped bits, they come up as text boxes that can be written to with the desired hex values:

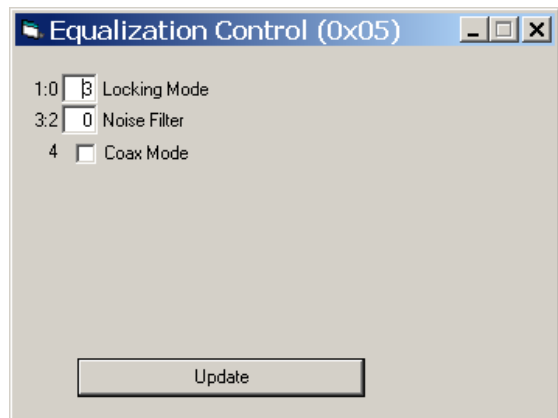

FIGURE 18. EQUALIZATION CONTROL

After the desired data has been entered, click "Update" to send the data to the device. The register view will be automatically updated.

## Saving and Loading Registers

To save all the registers values to a text delimited file, select the "Save Registers" option from the File menu.

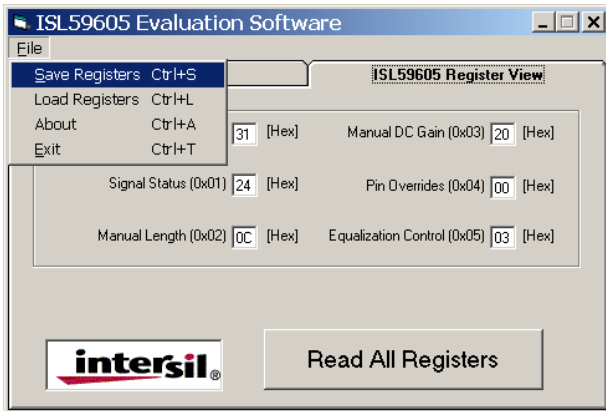

FIGURE 19. SAVING A REGISTER SET

Enter a filename and extension when prompted, and the program will save the file with that extension.

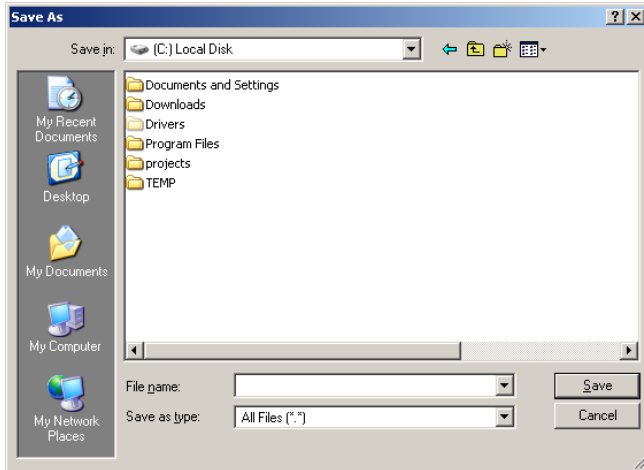

FIGURE 20. REGISTER SAVE DIALOG

Once saved, register files can be loaded using the "Load Registers" function.

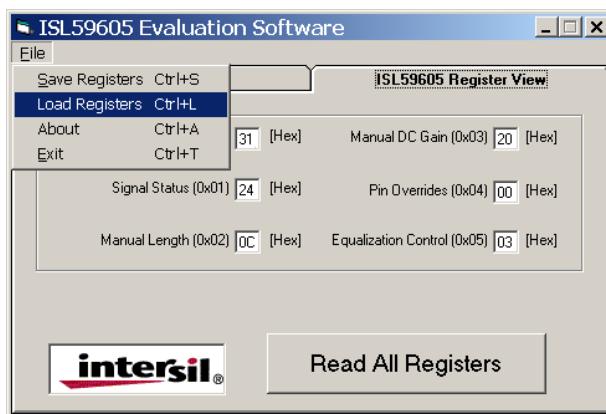

FIGURE 21. LOADING A REGISTER SET

Please refer to the ISL59605 datasheet for a more detailed description of the registers.

## Related Documents

- ISL5960x Datasheet ([FN6739](#))
- ISL59605-SPI-EVALZ Evaluation Board (with Serial Interface) Operation (Rev 5.0) ([AN1775](#))
- ISL59605-Catx-EVZ Evaluation Board ([AN1780](#))
- ISL59603-Coax-EVZ Evaluation Board ([AN1776](#))

## Troubleshooting

### Analog (ISL5960x) Troubleshooting

1. Verify that all the switches are in the correct position as described in "Switch Settings" on page 3.
2. Verify that JP1 is shorted (either with a jumper or an ammeter) so power will be applied to the IC.
3. Verify that there is 5V across the power supply pins, and that the board is drawing ~80mA of current. If you are seeing less current, JP1 may be open or the EQ\_DIS switch may be set to the wrong position.
4. Probe the IN+ and IN- pins for a video signal. For Cat x inputs, you should see a signal on both inputs (with IN- being the inverse of the signal on IN+). For coax inputs, you should see a signal on IN+ and a DC voltage on IN-. If you do not see the expected signals, inspect your cables, video sources, etc. For Cat x signals, verify that the jumpers in the jumper block are set correctly. If you are not certain which pair of Cat x wires is carrying the signal, you can probe the middle row of 8 pins in the jumper block, where you should see the signal on 2 of them.
5. If you see the correct input signal on IN+ and IN- but are still not seeing a valid output signal, toggle the INVERT switch high and low and then back to the center position to reset the chip.
6. Probe the VIDOUT2-75 test pin with a scope to see if there is a video signal. If you see a composite video signal, inspect your cables, video receiver, etc.
7. Verify that the FREEZE switch is in the correct position: "0" or "LOCKEDtoFREEZE" for stand-alone operation; "0" for software control.

### USB Driver Troubleshooting

The software should be able to communicate with the evaluation board as soon as it is launched. If there is a communication problem, the following dialog box may be displayed:



FIGURE 22. DEVICE NOT CONNECTED



After rebooting the PC, please verify that the following files are in the following locations:

- windrvr6.sys in C:\WINDOWS\system32\Driver
- usb\_interface.inf in C:\WINDOWS\INF
- . . . . . ISL59605.exe in C:\Program Files\Intersil\ISL59605

If you do see this dialog, open the Windows Control Panel. Double-click on the "System" icon, select the "Hardware" tab, then click on Device Manager:

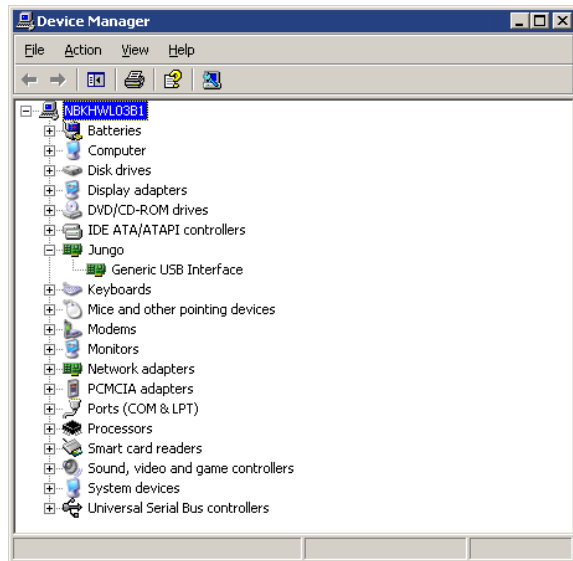
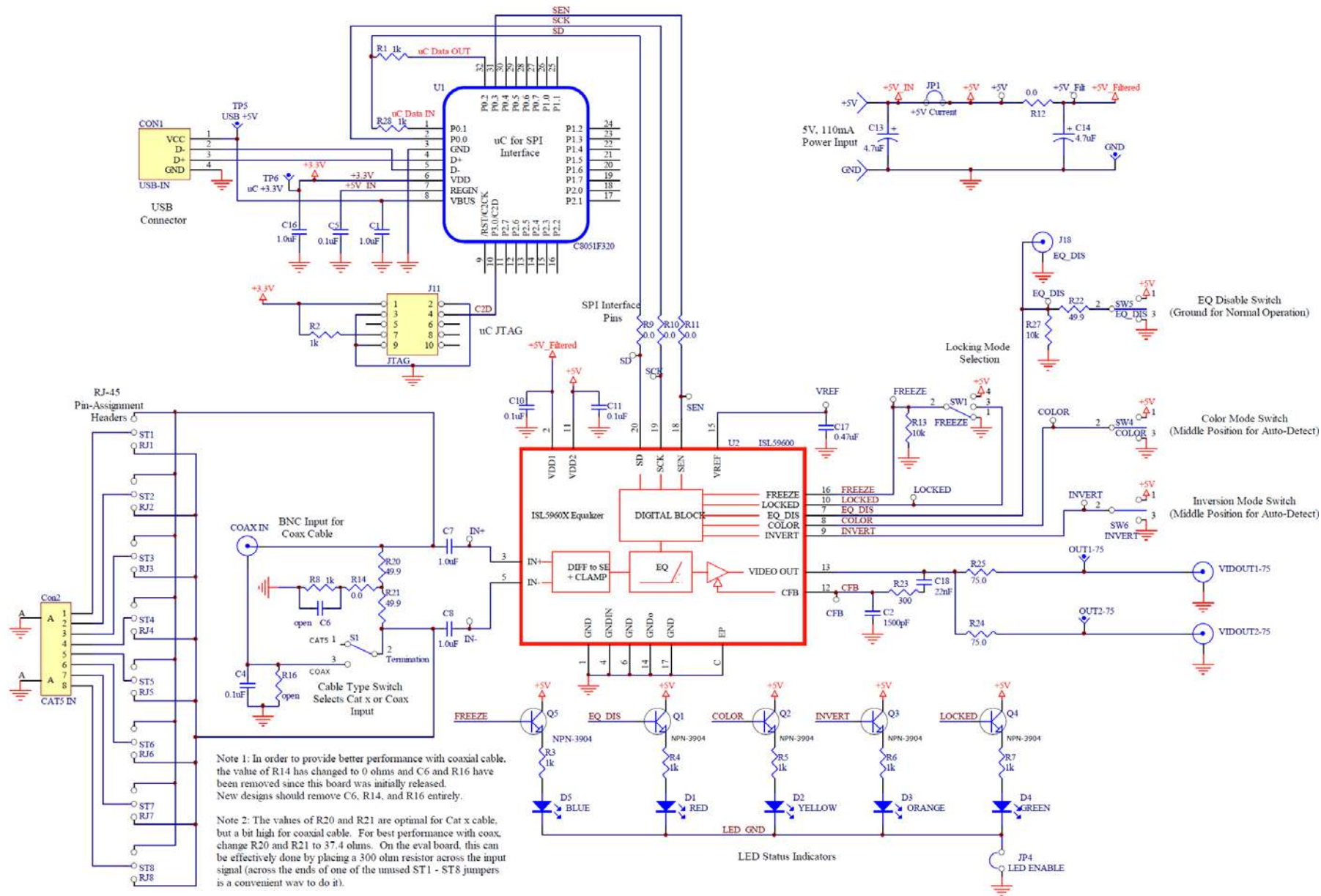

FIGURE 23. DEVICE MANAGER

There should be a "Jungo" entry, with an "Generic USB Interface" sub category. This indicates the driver is properly installed and is communicating with the evaluation board. If this is not visible, or there are any error messages, try the following actions:

- Verify that the evaluation board has power and the USB cable is connecting the evaluation board and the PC.
- Disconnect then reconnect the USB cable. You should hear 2 tones from the PC's speakers when the USB device is enumerated.
- Cycle power to the board.
- Close all instances of the ISL59605 application and restart the software. Restart the PC if necessary.
- If none of this works, try installing the software on a different PC isolate the cause to the PC vs. the evaluation board.
- Note: The ISL59605-SPI-EVALZ Evaluation Board has a USB Vendor ID (VID) of 0x09AA and Product ID (PID) of 0x200D.

# ISL59605-SPI-EVALZ Evaluation Board Schematic



Note 1: In order to provide better performance with coaxial cable, the value of R14 has changed to 0 ohms and C6 and R16 have been removed since this board was initially released. New designs should remove C6, R14, and R16 entirely.

Note 2: The values of R20 and R21 are optimal for Cat x cable, but a bit high for coaxial cable. For best performance with coax, change R20 and R21 to 37.4 ohms. On the eval board, this can be effectively done by placing a 300 ohm resistor across the input signal (across the ends of one of the unused ST1 - ST8 jumpers is a convenient way to do it).

## ISL59605-SPI-EVALZ Board Layout

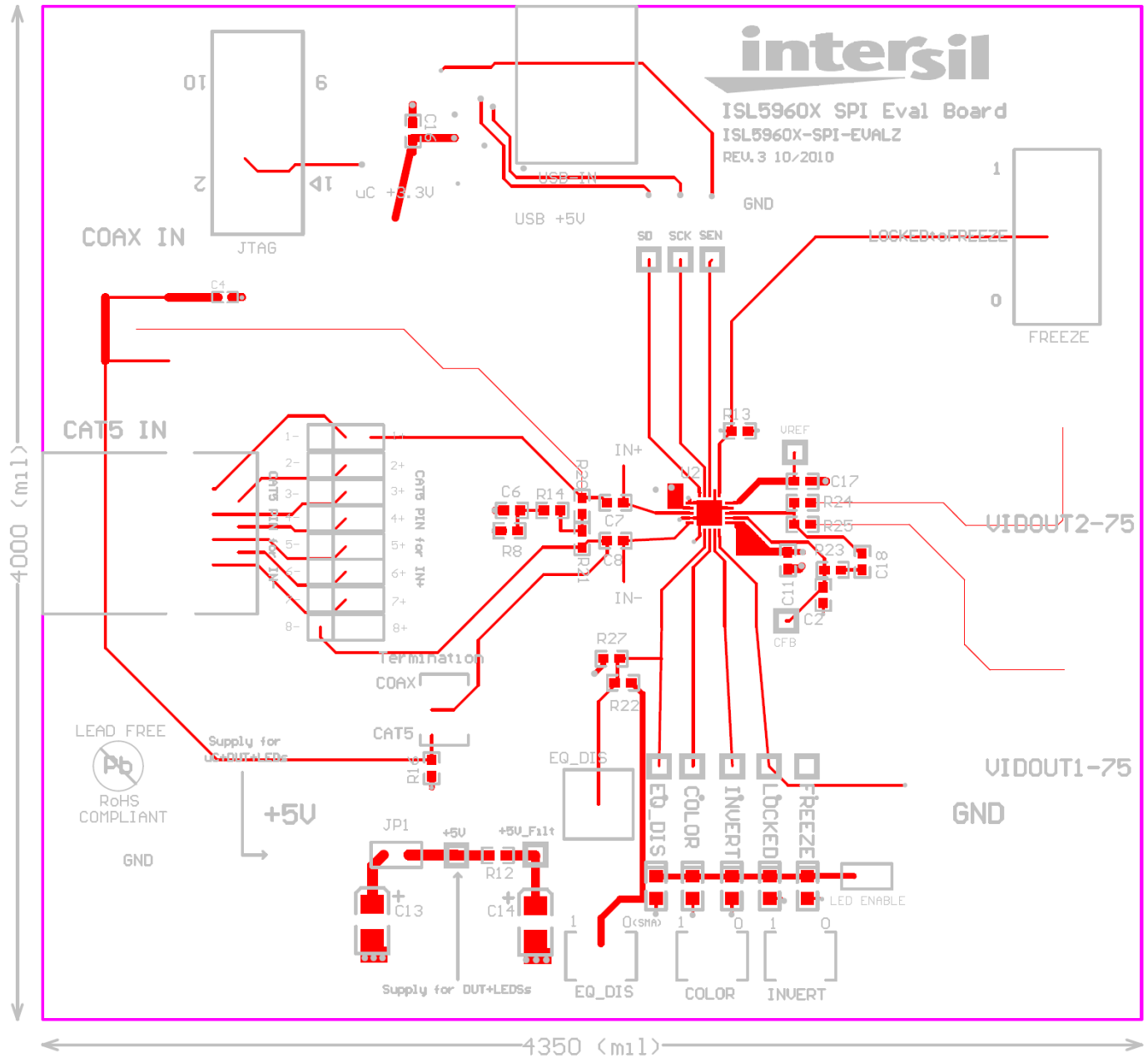

FIGURE 24. PCB TOP LAYER WITH SILKSCREEN

# ISL59605-SPI-EVALZ Board Layout (Continued)

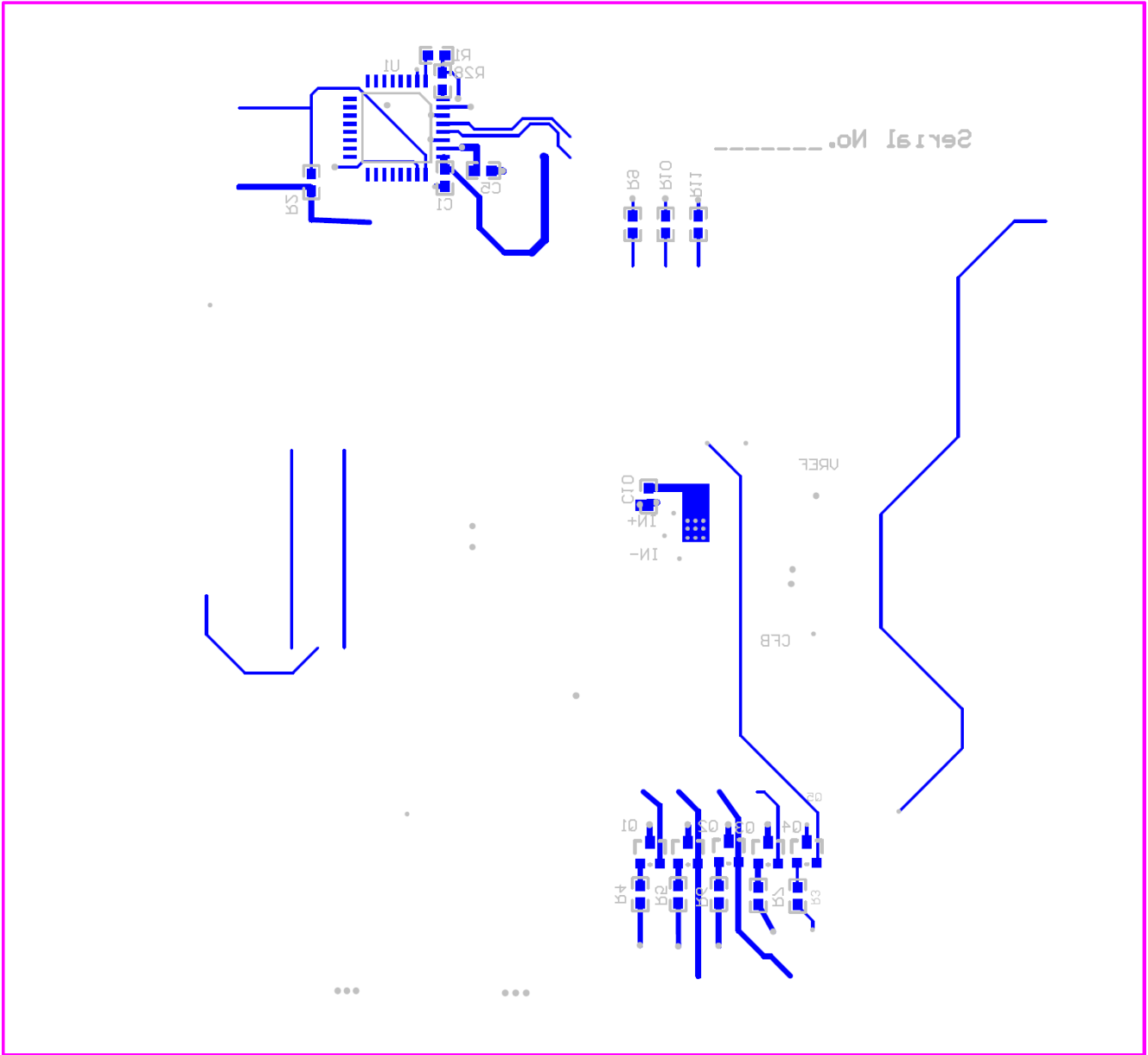

FIGURE 25. PCB BOTTOM LAYER WITH SILKSCREEN

# ISL59605-SPI-EVALZ Board Layout (Continued)

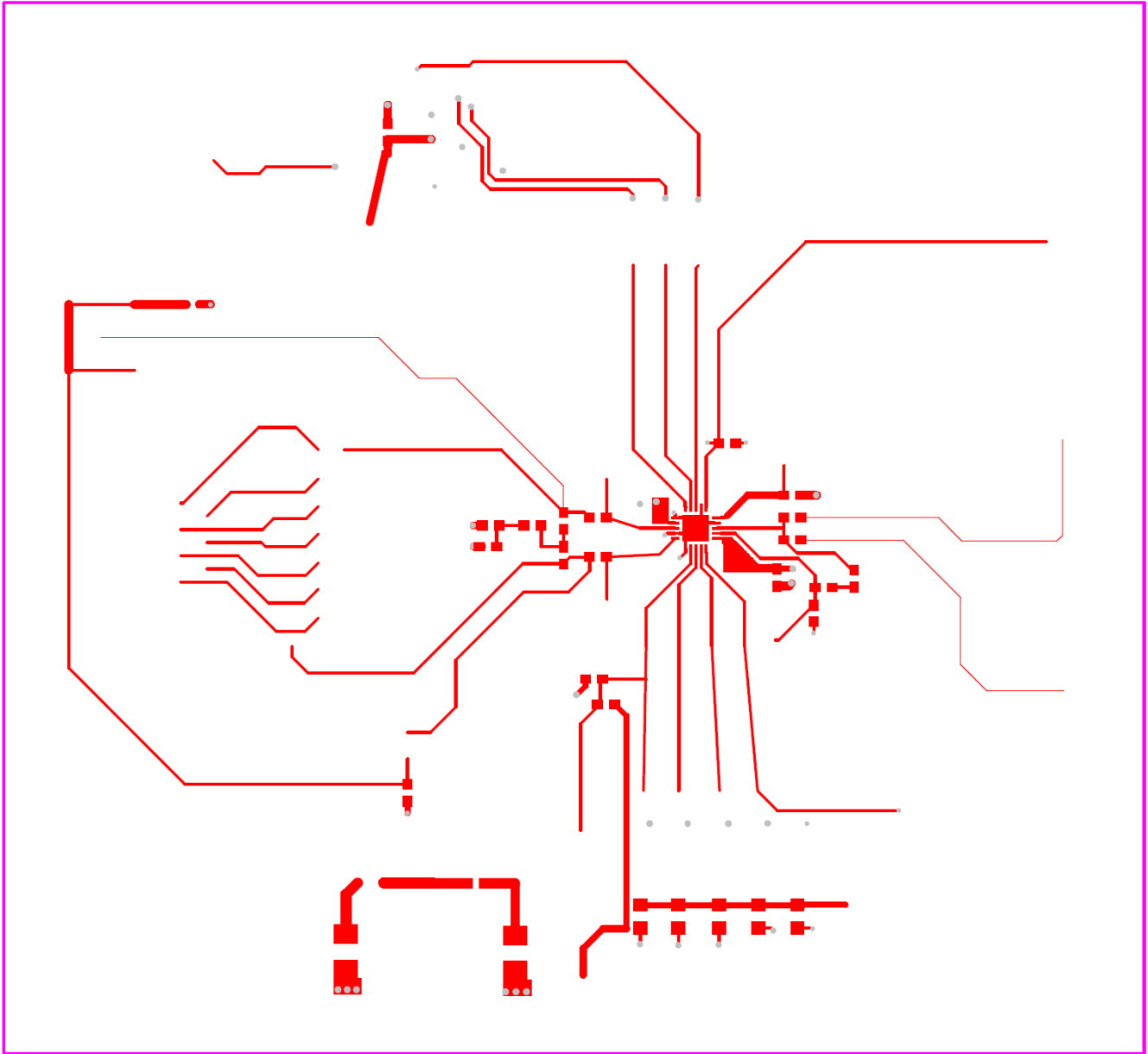

FIGURE 26. PCB TOP LAYER



# ISL59605-SPI-EVALZ Board Layout (Continued)

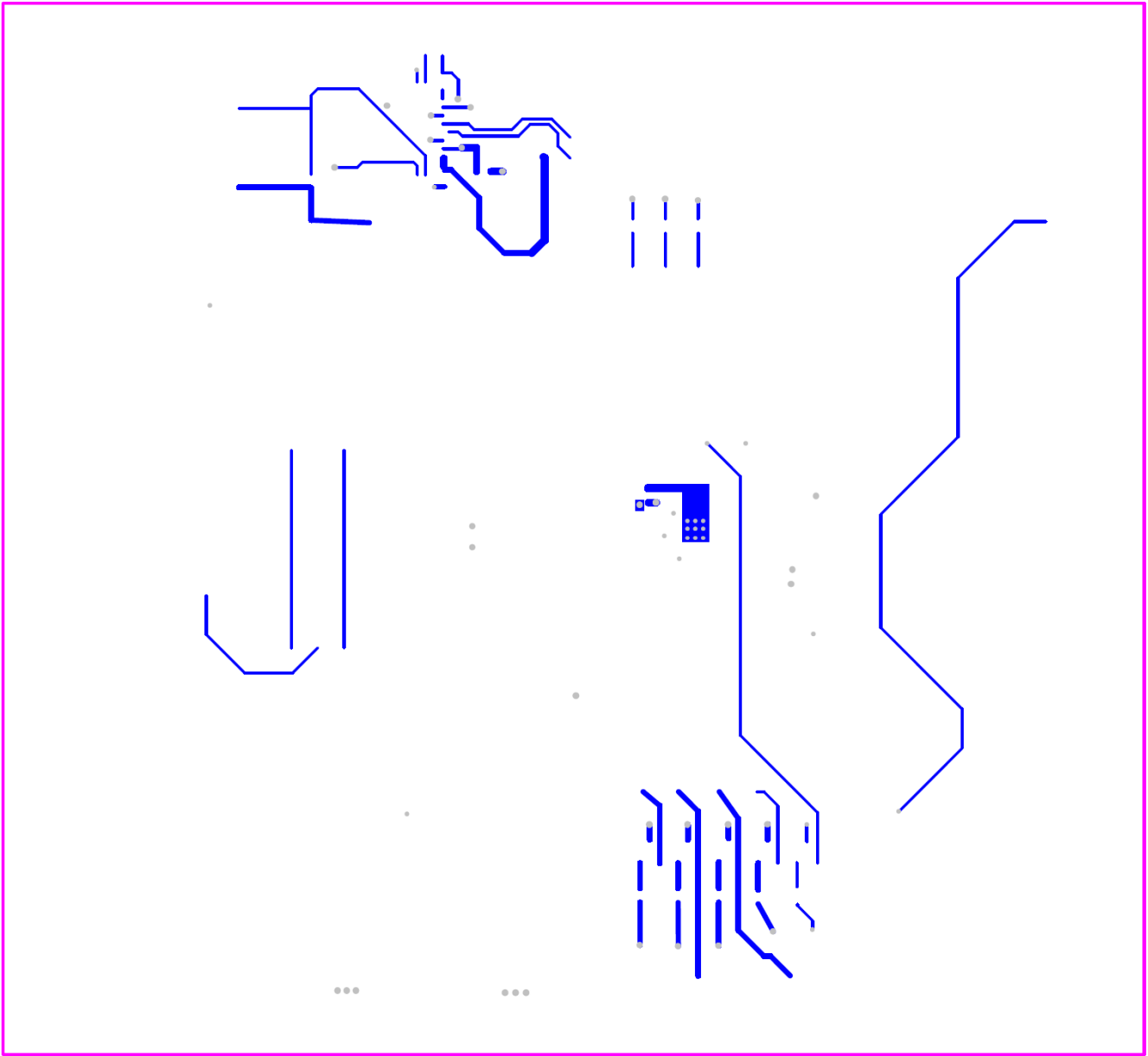

FIGURE 27. PCB BOTTOM LAYER

# ISL59605-SPI-EVALZ Board Layout (Continued)

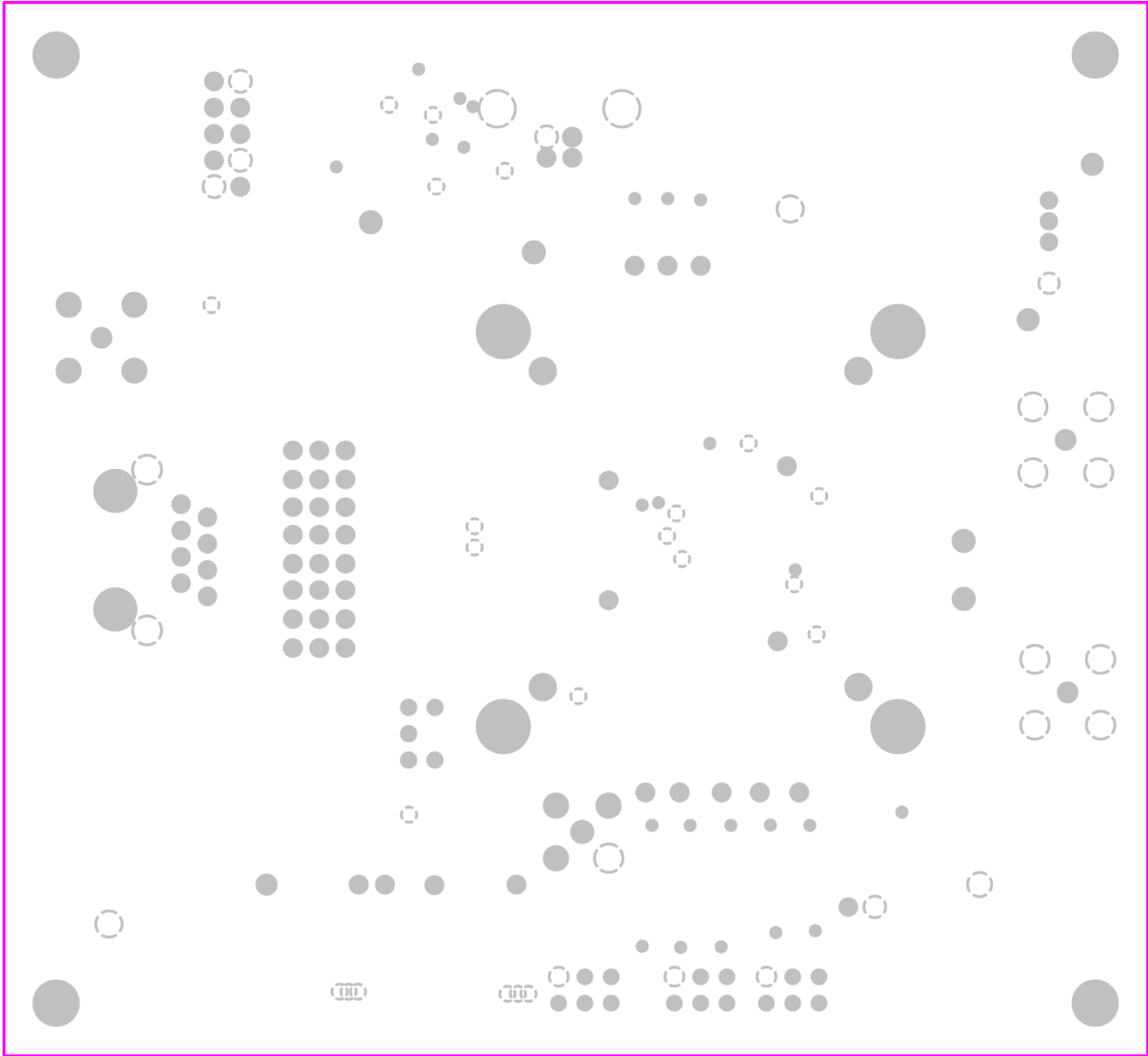

FIGURE 28. PCB INTERNAL PLANE 1 (GROUND)

# ISL59605-SPI-EVALZ Board Layout (Continued)

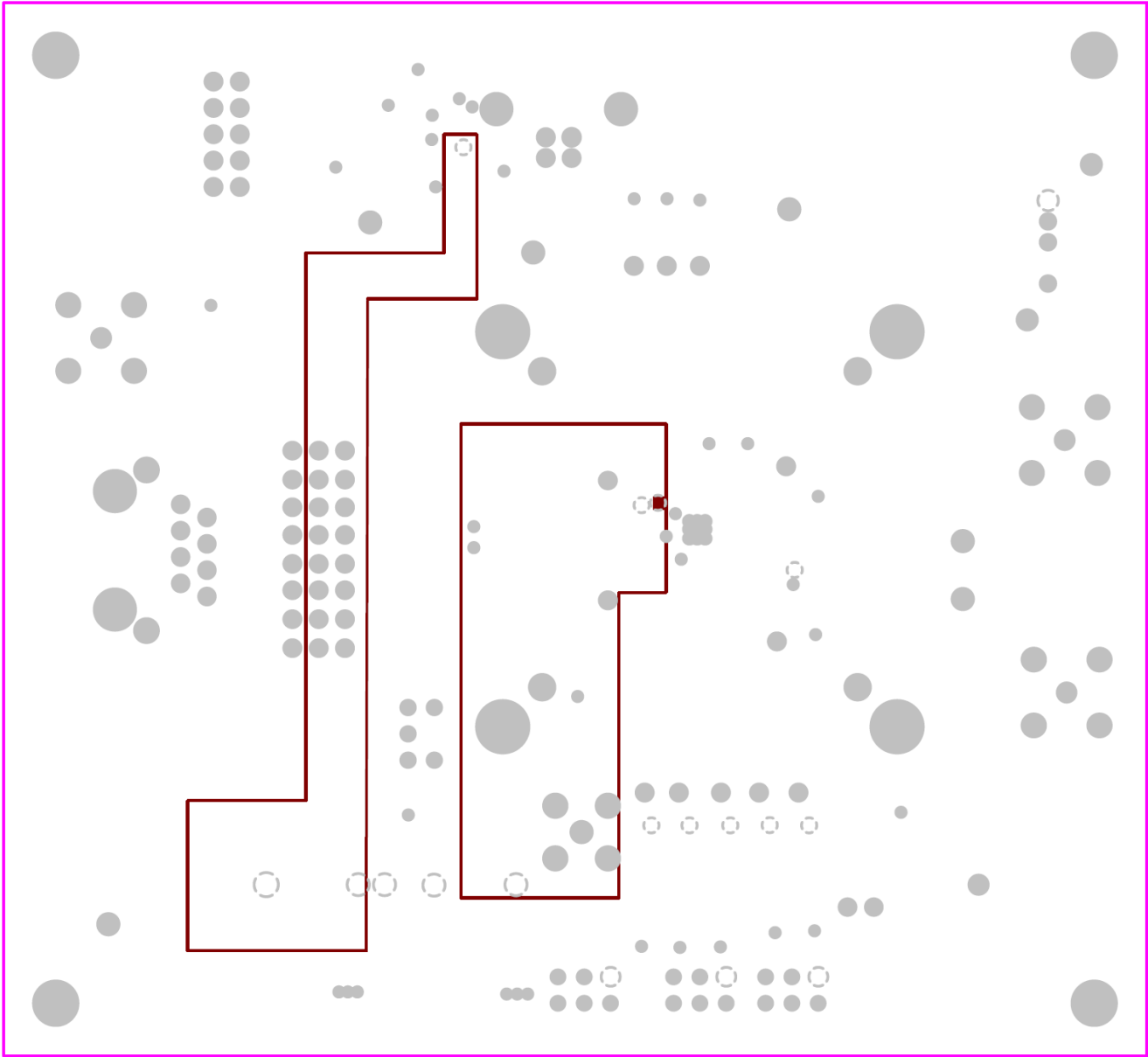

FIGURE 29. PCB INTERNAL PLANE 2 (POWER)

## Bill of Materials

QUANTITY	COMPONENT NAME	VALUE	FOOTPRINT
1	U2	ISL59605	QFN20 4MM
4	C1, C7, C8, C16	1.0 $\mu$ F	603
1	C2	1500pF	603
1	C4	0.1 $\mu$ F	402
4	C5, C6, C10, C11	0.1 $\mu$ F	603
2	C13, C14	4.7 $\mu$ F	3528
1	C17	0.47 $\mu$ F	603
1	C18	22nF	603
1	CON1	USB TYPE B FEMALE	USB TYPE-B(926)
1	CON2	CAT5 IN	Modular-8S
1	D1	RED	LED-0805
1	D2	YELLOW	LED-0805
1	D3	ORANGE	LED-0805
1	D4	GREEN	LED-0805
1	D5	BLUE	LED-0805
14	J1, J4, J5, J6, J7, J8, J12, J13, J15, J16, J17, J19, J20, J21	TEST POINTS	HEADER-1 PIN
2	J2, J3	POWER SUPPLY POSTS	POWERPOST
1	J11	JTAG	HEADER-10P SHROUDED
1	J18	SMB CONNECTOR	SMC/SMB
2	JP1, JP4	2-PIN JUMPER	JUMPER-2PIN
3	P1, P2, P3	BNC	BNC
5	Q1, Q2, Q3, Q4, Q5	NPN-3904	SOT-23
9	R1, R2, R3, R4, R5, R6, R7, R8, R28	1k	603
4	R9, R10, R11, R12	0	603
2	R13, R27	10k	603
1	R14	50	603
1	R16	10	603
3	R20, R21, R22	49.9	603
1	R23	300	603
2	R24, R25	75	603
1	S1	SP2T SWITCH	SWITCH-TOGGLE-GT11MCKE
1	SW1	FREEZE	SWITCH SP3T SLIDE-TH
3	SW4, SW5, SW6	SP2T SWITCH WITH NC	SWITCH-G13AP-ON-OFF-ON
8	ST1, ST2, ST3, ST4, ST5, ST6, ST7, ST8	3 PIN JUMPER	JUMPER-3PIN
6	TP1, TP2, TP5, TP6, TP14, TP15	GND	TESTPOINT
1	U1	C8051F320	LQFP32

## Notice

1. Descriptions of circuits, software and other related information in this document are provided only to illustrate the operation of semiconductor products and application examples. You are fully responsible for the incorporation or any other use of the circuits, software, and information in the design of your product or system. Renesas Electronics disclaims any and all liability for any losses and damages incurred by you or third parties arising from the use of these circuits, software, or information.
2. Renesas Electronics hereby expressly disclaims any warranties against and liability for infringement or any other claims involving patents, copyrights, or other intellectual property rights of third parties, by or arising from the use of Renesas Electronics products or technical information described in this document, including but not limited to, the product data, drawings, charts, programs, algorithms, and application examples.
3. No license, express, implied or otherwise, is granted hereby under any patents, copyrights or other intellectual property rights of Renesas Electronics or others.
4. You shall not alter, modify, copy, or reverse engineer any Renesas Electronics product, whether in whole or in part. Renesas Electronics disclaims any and all liability for any losses or damages incurred by you or third parties arising from such alteration, modification, copying or reverse engineering.
5. Renesas Electronics products are classified according to the following two quality grades: "Standard" and "High Quality". The intended applications for each Renesas Electronics product depends on the product's quality grade, as indicated below.  
"Standard": Computers; office equipment; communications equipment; test and measurement equipment; audio and visual equipment; home electronic appliances; machine tools; personal electronic equipment; industrial robots; etc.  
"High Quality": Transportation equipment (automobiles, trains, ships, etc.); traffic control (traffic lights); large-scale communication equipment; key financial terminal systems; safety control equipment; etc.  
Unless expressly designated as a high reliability product or a product for harsh environments in a Renesas Electronics data sheet or other Renesas Electronics document, Renesas Electronics products are not intended or authorized for use in products or systems that may pose a direct threat to human life or bodily injury (artificial life support devices or systems; surgical implantations; etc.), or may cause serious property damage (space system; undersea repeaters; nuclear power control systems; aircraft control systems; key plant systems; military equipment; etc.). Renesas Electronics disclaims any and all liability for any damages or losses incurred by you or any third parties arising from the use of any Renesas Electronics product that is inconsistent with any Renesas Electronics data sheet, user's manual or other Renesas Electronics document.
6. When using Renesas Electronics products, refer to the latest product information (data sheets, user's manuals, application notes, "General Notes for Handling and Using Semiconductor Devices" in the reliability handbook, etc.), and ensure that usage conditions are within the ranges specified by Renesas Electronics with respect to maximum ratings, operating power supply voltage range, heat dissipation characteristics, installation, etc. Renesas Electronics disclaims any and all liability for any malfunctions, failure or accident arising out of the use of Renesas Electronics products outside of such specified ranges.
7. Although Renesas Electronics endeavors to improve the quality and reliability of Renesas Electronics products, semiconductor products have specific characteristics, such as the occurrence of failure at a certain rate and malfunctions under certain use conditions. Unless designated as a high reliability product or a product for harsh environments in a Renesas Electronics data sheet or other Renesas Electronics document, Renesas Electronics products are not subject to radiation resistance design. You are responsible for implementing safety measures to guard against the possibility of bodily injury, injury or damage caused by fire, and/or danger to the public in the event of a failure or malfunction of Renesas Electronics products, such as safety design for hardware and software, including but not limited to redundancy, fire control and malfunction prevention, appropriate treatment for aging degradation or any other appropriate measures. Because the evaluation of microcomputer software alone is very difficult and impractical, you are responsible for evaluating the safety of the final products or systems manufactured by you.
8. Please contact a Renesas Electronics sales office for details as to environmental matters such as the environmental compatibility of each Renesas Electronics product. You are responsible for carefully and sufficiently investigating applicable laws and regulations that regulate the inclusion or use of controlled substances, including without limitation, the EU RoHS Directive, and using Renesas Electronics products in compliance with all these applicable laws and regulations. Renesas Electronics disclaims any and all liability for damages or losses occurring as a result of your noncompliance with applicable laws and regulations.
9. Renesas Electronics products and technologies shall not be used for or incorporated into any products or systems whose manufacture, use, or sale is prohibited under any applicable domestic or foreign laws or regulations. You shall comply with any applicable export control laws and regulations promulgated and administered by the governments of any countries asserting jurisdiction over the parties or transactions.
10. It is the responsibility of the buyer or distributor of Renesas Electronics products, or any other party who distributes, disposes of, or otherwise sells or transfers the product to a third party, to notify such third party in advance of the contents and conditions set forth in this document.
11. This document shall not be reprinted, reproduced or duplicated in any form, in whole or in part, without prior written consent of Renesas Electronics.
12. Please contact a Renesas Electronics sales office if you have any questions regarding the information contained in this document or Renesas Electronics products.  
(Note 1) "Renesas Electronics" as used in this document means Renesas Electronics Corporation and also includes its directly or indirectly controlled subsidiaries.  
(Note 2) "Renesas Electronics product(s)" means any product developed or manufactured by or for Renesas Electronics.

(Rev.4.0-1 November 2017)



### SALES OFFICES

Renesas Electronics Corporation

<http://www.renesas.com>

Refer to "<http://www.renesas.com/>" for the latest and detailed information.

**Renesas Electronics America Inc.**  
1001 Murphy Ranch Road, Milpitas, CA 95035, U.S.A.  
Tel: +1-408-432-8888, Fax: +1-408-434-5351

**Renesas Electronics Canada Limited**  
9251 Yonge Street, Suite 8309 Richmond Hill, Ontario Canada L4C 9T3  
Tel: +1-905-237-2004

**Renesas Electronics Europe Limited**  
Dukes Meadow, Millboard Road, Bourne End, Buckinghamshire, SL8 5FH, U.K  
Tel: +44-1628-651-700, Fax: +44-1628-651-804

**Renesas Electronics Europe GmbH**  
Arcadiastrasse 10, 40472 Düsseldorf, Germany  
Tel: +49-211-6503-0, Fax: +49-211-6503-1327

**Renesas Electronics (China) Co., Ltd.**  
Room 1709 Quantum Plaza, No.27 ZhichunLu, Haidian District, Beijing, 100191 P. R. China  
Tel: +86-10-8235-1155, Fax: +86-10-8235-7679

**Renesas Electronics (Shanghai) Co., Ltd.**  
Unit 301, Tower A, Central Towers, 555 Langao Road, Putuo District, Shanghai, 200333 P. R. China  
Tel: +86-21-2226-0888, Fax: +86-21-2226-0999

**Renesas Electronics Hong Kong Limited**  
Unit 1601-1611, 16/F., Tower 2, Grand Century Place, 193 Prince Edward Road West, Mongkok, Kowloon, Hong Kong  
Tel: +852-2265-6688, Fax: +852-2886-9022

**Renesas Electronics Taiwan Co., Ltd.**  
13F, No. 363, Fu Shing North Road, Taipei 10543, Taiwan  
Tel: +886-2-8175-9600, Fax: +886-2-8175-9670

**Renesas Electronics Singapore Pte. Ltd.**  
80 Bendemeer Road, Unit #06-02 Hyflux Innovation Centre, Singapore 339949  
Tel: +65-6213-0200, Fax: +65-6213-0300

**Renesas Electronics Malaysia Sdn.Bhd.**  
Unit 1207, Block B, Menara Amcorp, Amcorp Trade Centre, No. 18, Jln Persiaran Barat, 46050 Petaling Jaya, Selangor Darul Ehsan, Malaysia  
Tel: +60-3-7955-9390, Fax: +60-3-7955-9510

**Renesas Electronics India Pvt. Ltd.**  
No.777C, 100 Feet Road, HAL 2nd Stage, Indiranagar, Bangalore 560 038, India  
Tel: +91-80-67208700, Fax: +91-80-67208777

**Renesas Electronics Korea Co., Ltd.**  
17F, KAMCO Yangjae Tower, 262, Gangnam-daero, Gangnam-gu, Seoul, 06265 Korea  
Tel: +82-2-558-3737, Fax: +82-2-558-5338