

φ10 Cylinder Bracket L1 - Blue

SKU: 62435 Weight: 15.00 Gram

φ10 Cylinder Bracket L1 is suitable for cylinders with a bore size of 10mm (such as [Makeblock Double Acting Mini Cylinder MI10X60CA](#)). As a L-shaped bracket, it can be installed on the head, the bottom, or both sides of a cylinder. The long-hole design ensures the bracket to be compatible with Beam0824 and Beam 2424, hence realizes the function of fixing the cylinder.

Features:

- Diameter of the big round hole: φ12.2;
- Diameter of the long holes: φ4.1;
- Length of the long hole: 8mm.

Size Chart (mm):

Product Dimension Height/Width/Length: 24 x 18 x 26 mm (0.94 x 0.71 x 1.02 inch)

Package Dimension Height/Width/Length: 80 x 130 x 18 mm (3.15 x 5.12 x 0.71 inch)

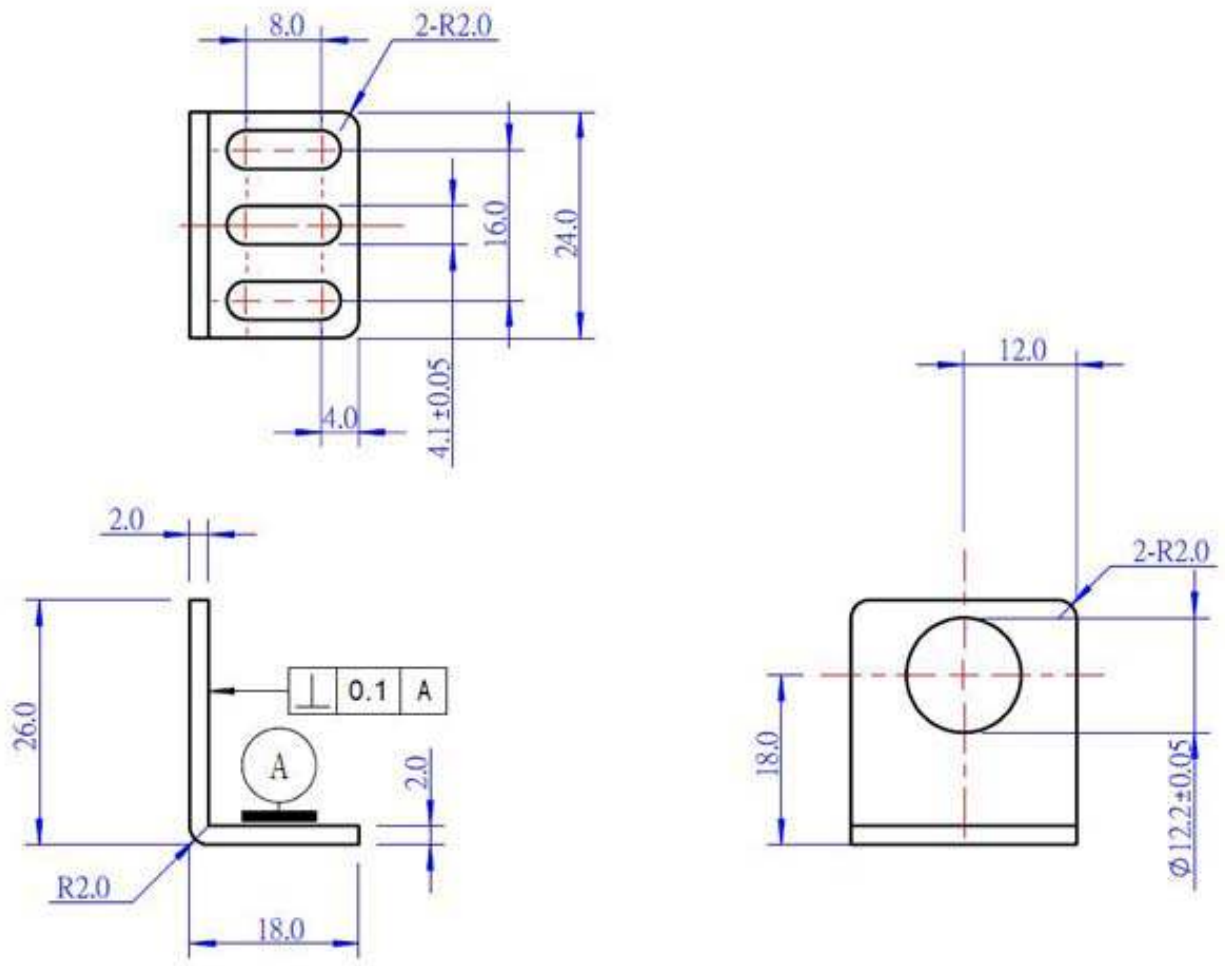

Part List:

1 x $\phi 10$ Cylinder Bracket L1 - Blue