



Bridgelux® Gen 8 Vero® 13 Array

Product Data Sheet DS421



Introduction

Vero® Series



The Vero® Series is a revolutionary advancement in chip on board (COB) light source technology and innovation, simplifying the luminaire design and manufacturing processes. Vero Chip on Board (COB) LED arrays are available in four LES configurations, engineered to enable new degrees of flexibility and reliability over a broad range of electrical currents. Vero arrays deliver increased lumen density to enable improved beam control and precision lighting with 2 and 3 SDCM color control standard for clean and consistent uniform lighting.

Vero products include an onboard connector port that enables a solder-free electrical interconnect, and simple mounting features for plug-and-play installation.

Features

- On board connector port
- Top side part number markings
- Efficacy of 178 lm/W typical, 3000K 80 CRI
- Reliable operation at up to 3x nominal current, 30% increase in maximum lumens per LES size
- Wide selection of CCT options (2700K-6500K) with minimum 70, 80 and 90 CRI options
- Uniform high-quality illumination
- 2 and 3 SDCM binning options (2700K – 4000K)
- Forward voltage bin codes (backside marking)
- Thermally isolated solder pads
- 10-Year warranty

Benefits

- Solder free installation and field upgradability
- Improved inventory management and quality control
- Enables high efficiency lighting systems and lower operating costs
- Supports the trend toward luminaire miniaturization and delivers enhanced optical control
- Design flexibility for a broad range of lighting applications
- Clean white light without pixelation
- Uniform consistent white light
- Design flexibility for multi-source applications
- Enhanced ease of use and installation
- Design with confidence

Contents

Product Feature Map	2
Product Nomenclature	2
Product Selection Guide	3
Performance at Commonly Used Drive Currents	7
Electrical Characteristics	16
Eye Safety	17
Absolute Maximum Ratings	18
Performance Curves	19
Typical Radiation Pattern	21
Typical Color Spectrum	22
Mechanical Dimensions	23
Color Binning Information	24
Packaging and Labeling	25
Design Resources	27
Precautions	27
Disclaimers	27
About Bridgelux	28

Product Feature Map

Vero 13 is the second smallest form factor in the Vero family of the next generation solid state light sources. In addition to delivering the performance and light quality required for many lighting applications, Vero incorporates

several features to simplify the design integration and manufacturing process, accelerate time to market and reduce system costs. Please visit www.bridgelux.com for more information on the Vero Series family of products.

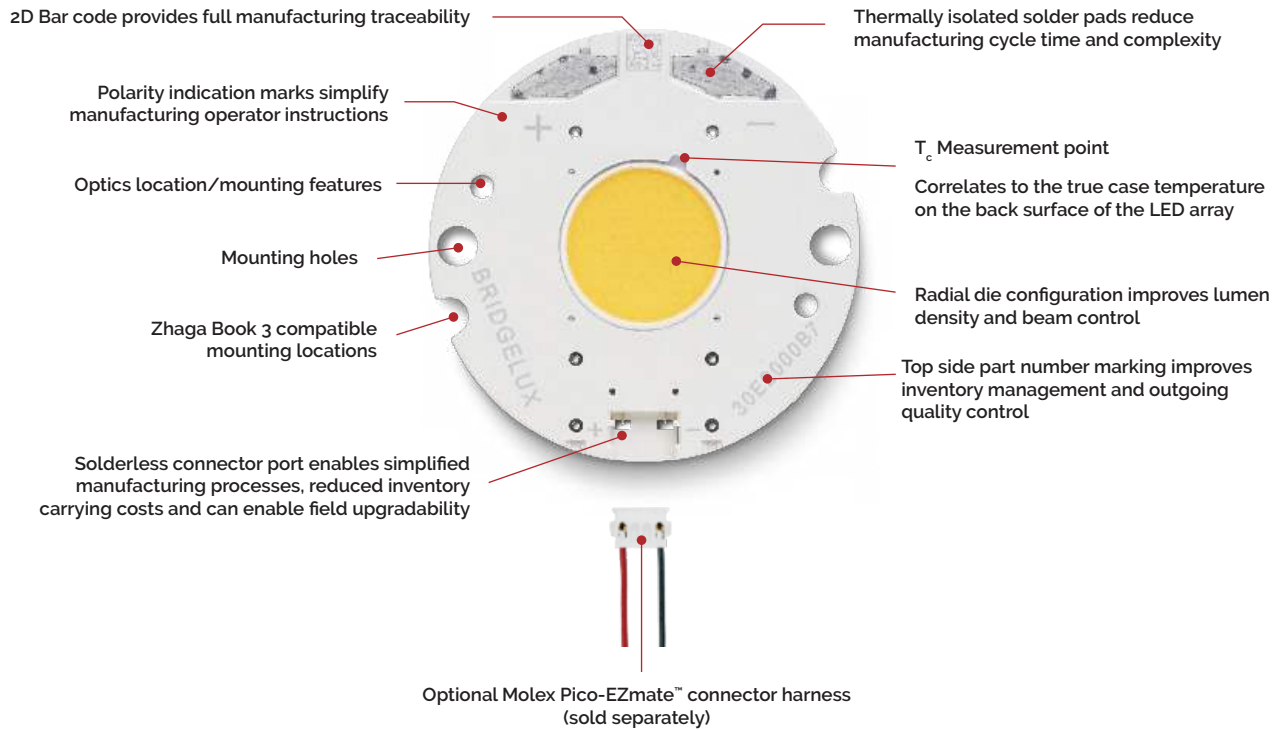

Product Nomenclature

The part number designation for Bridgelux Vero LED arrays is explained as follows:

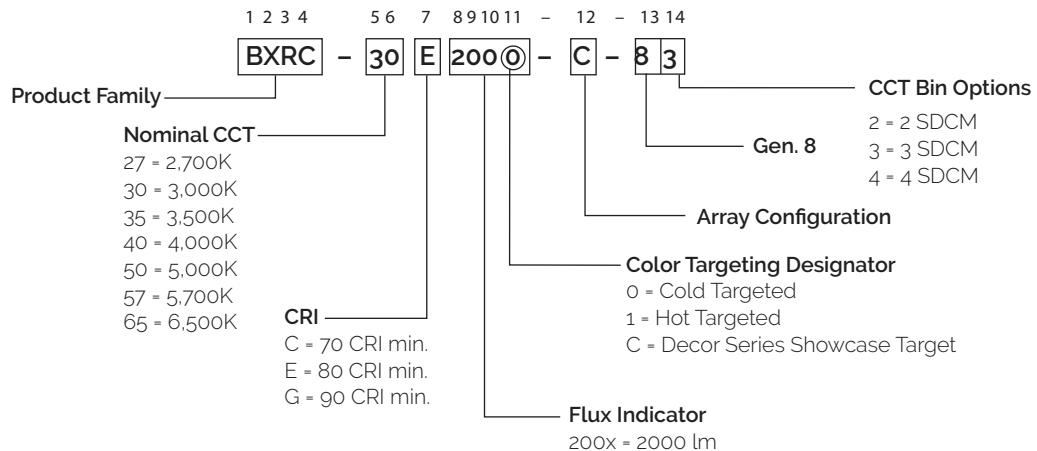

Product Selection Guide

The following product configurations are available:

Table 1: Selection Guide, Pulsed Measurement Data ($T_j = T_c = 25^\circ\text{C}$)

Part Number	Nominal CCT ¹ (K)	CRI ²	Nominal Drive Current ³ (mA)	Typical Pulsed Flux ^{4,5,6} $T_c = 25^\circ\text{C}$ (lm)	Minimum Pulsed Flux ^{6,7} $T_c = 25^\circ\text{C}$ (lm)	Typical V_f (V)	Typical Power (W)	Typical Efficacy (lm/W)
BXRC-27E2000-B-8x	2700	80	350	1963	1767	33.4	11.7	168
BXRC-27E2000-C-8x	2700	80	500	2805	2524	33.4	16.7	168
BXRC-27E2000-D-8x	2700	80	400	2068	1861	30.9	12.4	167
BXRC-27G2000-B-8x	2700	90	350	1620	1458	33.4	11.7	139
BXRC-27G2000-C-8x	2700	90	500	2314	2082	33.4	16.7	139
BXRC-27G2000-D-8x	2700	90	400	1706	1535	30.9	12.4	138
BXRC-27G20Ho-B-8x	2700	90	350	1690	1521	33.4	11.7	145
BXRC-27G20Ho-C-8x	2700	90	500	2414	2172	33.4	16.7	145
BXRC-27G20Ho-D-8x	2700	90	400	1780	1602	30.9	12.4	144
BXRC-30C2001-B-8x	3000	70	350	2184	1966	33.4	11.7	187
BXRC-30C2001-C-8x	3000	70	500	3120	2808	33.4	16.7	187
BXRC-30C2001-D-8x	3000	70	400	2300	2070	30.9	12.4	186
BXRC-30E2000-B-8x	3000	80	350	2086	1877	33.4	11.7	178
BXRC-30E2000-C-8x	3000	80	500	2980	2682	33.4	16.7	178
BXRC-30E2000-D-8x	3000	80	400	2197	1977	30.9	12.4	178
BXRC-30G2000-B-8x	3000	90	350	1693	1524	33.4	11.7	145
BXRC-30G2000-C-8x	3000	90	500	2419	2177	33.4	16.7	145
BXRC-30G2000-D-8x	3000	90	400	1783	1605	30.9	12.4	144
BXRC-30G20Ho-B-8x	3000	90	350	1773	1596	33.4	11.7	152
BXRC-30G20Ho-C-8x	3000	90	500	2533	2280	33.4	16.7	152
BXRC-30G20Ho-D-8x	3000	90	400	1867	1681	30.9	12.4	151
BXRC-35E2000-B-8x	3500	80	350	2135	1922	33.4	11.7	183
BXRC-35E2000-C-8x	3500	80	500	3050	2745	33.4	16.7	183
BXRC-35E2000-D-8x	3500	80	400	2249	2024	30.9	12.4	182
BXRC-35G2000-B-8x	3500	90	350	1755	1579	33.4	11.7	150
BXRC-35G2000-C-8x	3500	90	500	2507	2256	33.4	16.7	150
BXRC-35G2000-D-8x	3500	90	400	1848	1663	30.9	12.4	150
BXRC-40C2001-B-8x	4000	70	350	2246	2021	33.4	11.7	192
BXRC-40C2001-C-8x	4000	70	500	3208	2887	33.4	16.7	192
BXRC-40C2001-D-8x	4000	70	400	2365	2129	30.9	12.4	191
BXRC-40E2000-B-8x	4000	80	350	2147	1933	33.4	11.7	184
BXRC-40E2000-C-8x	4000	80	500	3068	2761	33.4	16.7	184
BXRC-40E2000-D-8x	4000	80	400	2262	2035	30.9	12.4	183

Notes for Table 1:

- Nominal CCT as defined by ANSI C78.377-2011. Products with a CCT of 5000K-6500K are hot targeted to $T_c = 85^\circ\text{C}$.
- CRI values are minimums for all products. Minimum Rg value for 80 CRI products is 0, the minimum Rg value for 90 CRI products is 50, the minimum Rg value for 97 CRI products is 93. Bridgelux maintains a ± 3 tolerance on CRI and Rg values.
- Drive current is referred to as nominal drive current.
- Products tested under pulsed condition (10ms pulse width) at nominal test current where T_j (junction temperature) - T_c (case temperature) = 25°C .
- Typical performance values are provided as a reference only and are not a guarantee of performance.
- Bridgelux maintains a $\pm 7\%$ tolerance on flux measurements.
- Minimum flux values at the nominal test current are guaranteed by 100% test.

Product Selection Guide

Table 1: Selection Guide, Pulsed Measurement Data ($T_j = T_c = 25^\circ\text{C}$) (continued)

Part Number	Nominal CCT ¹ (K)	CRI ²	Nominal Drive Current ³ (mA)	Typical Pulsed Flux ^{4,5,6} $T_c = 25^\circ\text{C}$ (lm)	Minimum Pulsed Flux ^{6,7} $T_c = 25^\circ\text{C}$ (lm)	Typical V_f (V)	Typical Power (W)	Typical Efficacy (lm/W)
BXRC-40G2000-B-8x	4000	90	350	1792	1612	33.4	11.7	153
BXRC-40G2000-C-8x	4000	90	500	2559	2303	33.4	16.7	153
BXRC-40G2000-D-8x	4000	90	400	1887	1698	30.9	12.4	153
BXRC-50C2001-B-8x	5000	70	350	2258	2032	33.4	11.7	193
BXRC-50C2001-C-8x	5000	70	500	3225	2903	33.4	16.7	193
BXRC-50C2001-D-8x	5000	70	400	2378	2140	30.9	12.4	192
BXRC-50E2001-B-8x	5000	80	350	2172	1955	33.4	11.7	186
BXRC-50E2001-C-8x	5000	80	500	3103	2792	33.4	16.7	186
BXRC-50E2001-D-8x	5000	80	400	2287	2059	30.9	12.4	185
BXRC-50G2001-B-8x	5000	90	350	1877	1690	33.4	11.7	161
BXRC-50G2001-C-8x	5000	90	500	2682	2414	33.4	16.7	161
BXRC-50G2001-D-8x	5000	90	400	1977	1780	30.9	12.4	160
BXRC-57C2001-B-8x	5700	70	350	2196	1977	33.4	11.7	188
BXRC-57C2001-C-8x	5700	70	500	3138	2824	33.4	16.7	188
BXRC-57C2001-D-8x	5700	70	400	2313	2082	30.9	12.4	187
BXRC-57E2001-B-8x	5700	80	350	2086	1877	33.4	11.7	178
BXRC-57E2001-C-8x	5700	80	500	2980	2682	33.4	16.7	178
BXRC-57E2001-D-8x	5700	80	400	2197	1977	30.9	12.4	178
BXRC-65C2001-B-8x	6500	70	350	2196	1977	33.4	11.7	188
BXRC-65C2001-C-8x	6500	70	500	3138	2824	33.4	16.7	188
BXRC-65C2001-D-8x	6500	70	400	2313	2082	30.9	12.4	187
BXRC-65E2001-B-8x	6500	80	350	2111	1899	33.4	11.7	181
BXRC-65E2001-C-8x	6500	80	500	3015	2714	33.4	16.7	181
BXRC-65E2001-D-8x	6500	80	400	2223	2001	30.9	12.4	180

Notes for Table 1:

- Nominal CCT as defined by ANSI C78.377-2011. Products with a CCT of 5000K-6500K are hot targeted to $T_c = 85^\circ\text{C}$.
- CRI values are minimums for all products. Minimum Rg value for 80 CRI products is 0, the minimum Rg value for 90 CRI products is 50. Bridgelux maintains a ± 3 tolerance on CRI and Rg values.
- Drive current is referred to as nominal drive current.
- Products tested under pulsed condition (10ms pulse width) at nominal test current where T_j (junction temperature) - T_c (case temperature) = 25°C .
- Typical performance values are provided as a reference only and are not a guarantee of performance.
- Bridgelux maintains a $\pm 7\%$ tolerance on flux measurements.
- Minimum flux values at the nominal test current are guaranteed by 100% test.

Product Selection Guide

Table 2: Selection Guide, Stabilized DC Performance ($T_c = 85^\circ\text{C}$)^{4,5}

Part Number	Nominal CCT ¹ (K)	CRI ²	Nominal Drive Current ³ (mA)	Typical DC Flux ^{4,5} $T_c = 85^\circ\text{C}$ (lm)	Minimum DC Flux ⁶ $T_c = 85^\circ\text{C}$ (lm)	Typical V_f (V)	Typical Power (W)	Typical Efficacy (lm/W)
BXRC-27E2000-B-8x	2700	80	350	1767	1590	32.7	11.4	154
BXRC-27E2000-C-8x	2700	80	500	2524	2272	32.7	16.3	154
BXRC-27E2000-D-8x	2700	80	400	1861	1675	30.2	12.1	154
BXRC-27G2000-B-8x	2700	90	350	1458	1312	32.7	11.4	127
BXRC-27G2000-C-8x	2700	90	500	2082	1874	32.7	16.3	127
BXRC-27G2000-D-8x	2700	90	400	1535	1382	30.2	12.1	127
BXRC-27G20Ho-B-8x	2700	90	350	1521	1369	32.7	11.4	133
BXRC-27G20Ho-C-8x	2700	90	500	2172	1955	32.7	16.3	133
BXRC-27G20Ho-D-8x	2700	90	400	1602	1441	30.2	12.1	132
BXRC-30C2001-B-8x	3000	70	350	1966	1769	32.7	11.4	172
BXRC-30C2001-C-8x	3000	70	500	2808	2527	32.7	16.3	172
BXRC-30C2001-D-8x	3000	70	400	2070	1863	30.2	12.1	171
BXRC-30E2000-B-8x	3000	80	350	1877	1690	32.7	11.4	164
BXRC-30E2000-C-8x	3000	80	500	2682	2414	32.7	16.3	164
BXRC-30E2000-D-8x	3000	80	400	1977	1780	30.2	12.1	164
BXRC-30G2000-B-8x	3000	90	350	1524	1372	32.7	11.4	133
BXRC-30G2000-C-8x	3000	90	500	2177	1959	32.7	16.3	133
BXRC-30G2000-D-8x	3000	90	400	1605	1445	30.2	12.1	133
BXRC-30G20Ho-B-8x	3000	90	350	1596	1436	32.7	11.4	140
BXRC-30G20Ho-C-8x	3000	90	500	2280	2052	32.7	16.3	140
BXRC-30G20Ho-D-8x	3000	90	400	1681	1513	30.2	12.1	139
BXRC-35E2000-B-8x	3500	80	350	1922	1729	32.7	11.4	168
BXRC-35E2000-C-8x	3500	80	500	2745	2471	32.7	16.3	168
BXRC-35E2000-D-8x	3500	80	400	2024	1821	30.2	12.1	167
BXRC-35G2000-B-8x	3500	90	350	1579	1421	32.7	11.4	138
BXRC-35G2000-C-8x	3500	90	500	2256	2030	32.7	16.3	138
BXRC-35G2000-D-8x	3500	90	400	1663	1497	30.2	12.1	138
BXRC-40C2001-B-8x	4000	70	350	2021	1819	32.7	11.4	177
BXRC-40C2001-C-8x	4000	70	500	2887	2598	32.7	16.3	177
BXRC-40C2001-D-8x	4000	70	400	2129	1916	30.2	12.1	176
BXRC-40E2000-B-8x	4000	80	350	1933	1739	32.7	11.4	169
BXRC-40E2000-C-8x	4000	80	500	2761	2485	32.7	16.3	169
BXRC-40E2000-D-8x	4000	80	400	2035	1832	30.2	12.1	168
BXRC-40G2000-B-8x	4000	90	350	1612	1451	32.7	11.4	141
BXRC-40G2000-C-8x	4000	90	500	2303	2073	32.7	16.3	141
BXRC-40G2000-D-8x	4000	90	400	1698	1528	30.2	12.1	140

Notes for Table 2:

- Nominal CCT as defined by ANSI C78.377-2011. Products with a CCT of 5000K-6500K are hot targeted to $T_c = 85^\circ\text{C}$.
- CRI values are minimums for all other products. Minimum Rg value for 80 CRI products is 0, the minimum Rg value for 90 CRI products is 50. Bridgelux maintains a ± 3 tolerance on CRI and Rg values.
- Drive current is referred to as nominal drive current.
- Typical stabilized DC performance values are provided as reference only and are not a guarantee of performance.
- Typical performance is estimated based on operation under DC (direct current) with LED array mounted onto a heat sink with thermal interface material and the case temperature maintained at 85°C . Based on Bridgelux test setup, values may vary depending on the thermal design of the luminaire and/or the exposed environment to which the product is subjected.
- Minimum flux values at elevated temperatures are provided for reference only and are not guaranteed by 100% production testing. Based on Bridgelux test setup, values may vary depending on the thermal design of the luminaire and/or the exposed environment to which the product is subjected.

Product Selection Guide

Table 2: Selection Guide, Stabilized DC Performance ($T_c = 85^\circ\text{C}$)^{4,5} (continued)

Part Number	Nominal CCT ¹ (K)	CRI ²	Nominal Drive Current ³ (mA)	Typical DC Flux ^{4,5} $T_c = 85^\circ\text{C}$ (lm)	Minimum DC Flux ⁶ $T_c = 85^\circ\text{C}$ (lm)	Typical V_f (V)	Typical Power (W)	Typical Efficacy (lm/W)
BXRC-50C2001-B-8x	5000	70	350	2032	1829	32.7	11.4	178
BXRC-50C2001-C-8x	5000	70	500	2903	2613	32.7	16.3	178
BXRC-50C2001-D-8x	5000	70	400	2140	1926	30.2	12.1	177
BXRC-50E2001-B-8x	5000	80	350	1955	1759	32.7	11.4	171
BXRC-50E2001-C-8x	5000	80	500	2792	2513	32.7	16.3	171
BXRC-50E2001-D-8x	5000	80	400	2059	1853	30.2	12.1	170
BXRC-50G2001-B-8x	5000	90	350	1690	1521	32.7	11.4	148
BXRC-50G2001-C-8x	5000	90	500	2414	2172	32.7	16.3	148
BXRC-50G2001-D-8x	5000	90	400	1780	1602	30.2	12.1	147
BXRC-57C2001-B-8x	5700	70	350	1977	1779	32.7	11.4	173
BXRC-57C2001-C-8x	5700	70	500	2824	2542	32.7	16.3	173
BXRC-57C2001-D-8x	5700	70	400	2082	1874	30.2	12.1	172
BXRC-57E2001-B-8x	5700	80	350	1877	1690	32.7	11.4	164
BXRC-57E2001-C-8x	5700	80	500	2682	2414	32.7	16.3	164
BXRC-57E2001-D-8x	5700	80	400	1977	1780	30.2	12.1	164
BXRC-65C2001-B-8x	6500	70	350	1977	1779	32.7	11.4	173
BXRC-65C2001-C-8x	6500	70	500	2824	2542	32.7	16.3	173
BXRC-65C2001-D-8x	6500	70	400	2082	1874	30.2	12.1	172
BXRC-65E2001-B-8x	6500	80	350	1899	1710	32.7	11.4	166
BXRC-65E2001-C-8x	6500	80	500	2714	2442	32.7	16.3	166
BXRC-65E2001-D-8x	6500	80	400	2001	1801	30.2	12.1	165

Notes for Table 2:

- Nominal CCT as defined by ANSI C78.377-2011. Products with a CCT of 5000K-6500K are not targeted to $T_c = 85^\circ\text{C}$.
- CRI values are minimums for all other products. Minimum Rg value for 80 CRI products is 0, the minimum Rg value for 90 CRI products is 50. Bridgelux maintains a ± 3 tolerance on CRI and Rg values.
- Drive current is referred to as nominal drive current.
- Typical stabilized DC performance values are provided as reference only and are not a guarantee of performance.
- Typical performance is estimated based on operation under DC (direct current) with LED array mounted onto a heat sink with thermal interface material and the case temperature maintained at 85°C . Based on Bridgelux test setup, values may vary depending on the thermal design of the luminaire and/or the exposed environment to which the product is subjected.
- Minimum flux values at elevated temperatures are provided for reference only and are not guaranteed by 100% production testing. Based on Bridgelux test setup, values may vary depending on the thermal design of the luminaire and/or the exposed environment to which the product is subjected.

Performance at Commonly Used Drive Currents

Vero LED arrays are tested to the specifications shown using the nominal drive currents in Table 1. Vero may also be driven at other drive currents dependent on specific application design requirements. The performance at any drive current can be derived from the current vs. voltage characteristics shown in Figures 1, 2 & 3 and the flux vs. current characteristics shown in Figures 4, 5 & 6. The performance at commonly used drive currents is summarized in Table 3.

Table 3: Product Performance at Commonly Used Drive Currents

Part Number	CRI	Drive Current ¹ (mA)	Typical V _f T _c = 25°C (V)	Typical Power T _c = 25°C (W)	Typical Flux ² T _c = 25°C (lm)	Typical DC Flux ³ T _c = 85°C (lm)	Typical Efficacy T _c = 25°C (lm/W)
BXRC-27E2000-B-8x	80	175	32.4	5.7	1019	917	179
		260	32.9	8.6	1476	1329	173
		350	33.4	11.7	1963	1767	168
		450	33.9	15.3	2478	2230	162
		700	35.2	24.6	3750	3375	152
		1250	37.6	47.0	6363	5727	135
BXRC-27E2000-C-8x	80	250	32.5	8.1	1455	1310	179
		375	33.0	12.4	2128	1916	172
		500	33.4	16.7	2805	2524	168
		630	33.9	21.4	3473	3126	163
		1000	35.2	35.2	5357	4821	152
		1750	37.5	65.7	8928	8035	136
BXRC-27E2000-D-8x	80	200	30.0	6.0	1073	965	179
		300	30.4	9.1	1569	1412	172
		400	30.9	12.3	2068	1861	168
		500	31.3	15.6	2542	2287	163
		800	32.5	26.0	3950	3555	152
		1250	34.1	42.7	5947	5352	139
BXRC-27G2000-B-8x	90	175	32.4	5.7	840	756	148
		260	32.9	8.6	1218	1096	142
		350	33.4	11.7	1620	1458	139
		450	33.9	15.3	2044	1840	134
		700	35.2	24.6	3094	2784	126
		1250	37.6	47.0	5250	4725	112
BXRC-27G2000-C-8x	90	250	32.5	8.1	1200	1080	148
		375	33.0	12.4	1756	1580	142
		500	33.4	16.7	2314	2082	138
		630	33.9	21.4	2866	2579	134
		1000	35.2	35.2	4420	3978	126
		1750	37.5	65.7	7366	6629	112
BXRC-27G2000-D-8x	90	200	30.0	6.0	885	797	148
		300	30.4	9.1	1295	1165	142
		400	30.9	12.3	1706	1535	138
		500	31.3	15.6	2097	1887	134
		800	32.5	26.0	3258	2933	125
		1250	34.1	42.7	4906	4416	115

Notes for Table 3:

1. Alternate drive currents in Table 3 are provided for reference only and are not a guarantee of performance.
2. Bridgelux maintains a ± 7% tolerance on flux measurements.
3. Typical stabilized DC performance values are provided as reference only and are not a guarantee of performance.

Performance at Commonly Used Drive Currents

Table 3: Product Performance at Commonly Used Drive Currents (Continued)

Part Number	CRI	Drive Current ¹ (mA)	Typical V _f T _c = 25°C (V)	Typical Power T _c = 25°C (W)	Typical Flux ² T _c = 25°C (lm)	Typical DC Flux ³ T _c = 85°C (lm)	Typical Efficacy T _c = 25°C (lm/W)
BXRC-27G20H0-B-8x	90	175	32.4	5.7	877	789	154
		260	32.9	8.6	1271	1144	149
		350	33.4	11.7	1690	1521	145
		450	33.9	15.3	2133	1920	140
		700	35.2	24.6	3227	2905	131
		1250	37.6	47.0	5476	4929	117
BXRC-27G20H0-C-8x	90	250	32.5	8.1	1252	1127	154
		375	33.0	12.4	1832	1649	148
		500	33.4	16.7	2414	2172	144
		630	33.9	21.4	2989	2690	140
		1000	35.2	35.2	4610	4149	131
		1750	37.5	65.7	7684	6916	117
BXRC-27G20H0-D-8x	90	200	30.0	6.0	923	831	154
		300	30.4	9.1	1350	1215	148
		400	30.9	12.3	1780	1602	144
		500	31.3	15.6	2187	1969	140
		800	32.5	26.0	3399	3059	131
		1250	34.1	42.7	5118	4606	120
BXRC-30C2001-B-8x	70	175	32.4	5.7	1133	1020	200
		260	32.9	8.6	1643	1478	192
		350	33.4	11.7	2184	1966	187
		450	33.9	15.3	2757	2481	181
		700	35.2	24.6	4172	3755	169
		1250	37.6	47.0	7079	6371	151
BXRC-30C2001-C-8x	70	250	32.5	8.1	1619	1457	199
		375	33.0	12.4	2368	2131	192
		500	33.4	16.7	3120	2808	187
		630	33.9	21.4	3864	3478	181
		1000	35.2	35.2	5960	5364	169
		1750	37.5	65.7	9933	8939	151
BXRC-30C2001-D-8x	70	200	30.0	6.0	1193	1074	199
		300	30.4	9.1	1746	1571	191
		400	30.9	12.3	2300	2070	186
		500	31.3	15.6	2828	2545	181
		800	32.5	26.0	4394	3954	169
		1250	34.1	42.7	6616	5954	155
BXRC-30E2000-B-8x	80	175	32.4	5.7	1082	974	191
		260	32.9	8.6	1569	1412	183
		350	33.4	11.7	2086	1877	178
		450	33.9	15.3	2633	2370	172
		700	35.2	24.6	3984	3586	162
		1250	37.6	47.0	6761	6085	144

Notes for Table 3:

1. Alternate drive currents in Table 3 are provided for reference only and are not a guarantee of performance.
2. Bridgelux maintains a ± 7% tolerance on flux measurements.
3. Typical stabilized DC performance values are provided as reference only and are not a guarantee of performance.

Performance at Commonly Used Drive Currents

Table 3: Product Performance at Commonly Used Drive Currents (Continued)

Part Number	CRI	Drive Current ¹ (mA)	Typical V _f T _c = 25°C (V)	Typical Power T _c = 25°C (W)	Typical Flux ² T _c = 25°C (lm)	Typical DC Flux ³ T _c = 85°C (lm)	Typical Efficacy T _c = 25°C (lm/W)
BXRC-30E2000-C-8x	80	250	32.5	8.1	1546	1391	190
		375	33.0	12.4	2261	2035	183
		500	33.4	16.7	2980	2682	178
		630	33.9	21.4	3691	3321	173
		1000	35.2	35.2	5692	5123	162
		1750	37.5	65.7	9486	8538	144
BXRC-30E2000-D-8x	80	200	30.0	6.0	1140	1026	190
		300	30.4	9.1	1667	1500	183
		400	30.9	12.3	2197	1977	178
		500	31.3	15.6	2700	2430	173
		800	32.5	26.0	4196	3777	161
		1250	34.1	42.7	6319	5687	148
BXRC-30G2000-B-8x	90	175	32.4	5.7	878	791	155
		260	32.9	8.6	1273	1146	149
		350	33.4	11.7	1693	1524	145
		450	33.9	15.3	2137	1924	140
		700	35.2	24.6	3234	2911	131
		1250	37.6	47.0	5488	4939	117
BXRC-30G2000-C-8x	90	250	32.5	8.1	1255	1129	155
		375	33.0	12.4	1836	1652	149
		500	33.4	16.7	2419	2177	145
		630	33.9	21.4	2996	2696	140
		1000	35.2	35.2	4621	4158	131
		1750	37.5	65.7	7701	6931	117
BXRC-30G2000-D-8x	90	200	30.0	6.0	925	833	154
		300	30.4	9.1	1353	1218	148
		400	30.9	12.3	1783	1605	145
		500	31.3	15.6	2192	1973	140
		800	32.5	26.0	3406	3066	131
		1250	34.1	42.7	5129	4616	120
BXRC-30G20H0-B-8x	90	175	32.4	5.7	920	828	162
		260	32.9	8.6	1333	1200	156
		350	33.4	11.7	1773	1596	152
		450	33.9	15.3	2238	2014	147
		700	35.2	24.6	3387	3048	138
		1250	37.6	47.0	5747	5172	122
BXRC-30G20H0-C-8x	90	250	32.5	8.1	1314	1183	162
		375	33.0	12.4	1922	1730	156
		500	33.4	16.7	2533	2280	152
		630	33.9	21.4	3137	2823	147
		1000	35.2	35.2	4838	4354	137
		1750	37.5	65.7	8063	7257	123

Notes for Table 3:

1. Alternate drive currents in Table 3 are provided for reference only and are not a guarantee of performance.
2. Bridgelux maintains a ± 7% tolerance on flux measurements.
3. Typical stabilized DC performance values are provided as reference only and are not a guarantee of performance.

Performance at Commonly Used Drive Currents

Table 3: Product Performance at Commonly Used Drive Currents (Continued)

Part Number	CRI	Drive Current ¹ (mA)	Typical V_f $T_c = 25^\circ\text{C}$ (V)	Typical Power $T_c = 25^\circ\text{C}$ (W)	Typical Flux ² $T_c = 25^\circ\text{C}$ (lm)	Typical DC Flux ³ $T_c = 85^\circ\text{C}$ (lm)	Typical Efficacy $T_c = 25^\circ\text{C}$ (lm/W)
BXRC-30G20H0-D-8x	90	200	30.0	6.0	969	872	162
		300	30.4	9.1	1417	1275	155
		400	30.9	12.3	1867	1681	151
		500	31.3	15.6	2295	2066	147
		800	32.5	26.0	3567	3210	137
		1250	34.1	42.7	5371	4834	126
BXRC-35E2000-B-8x	80	175	32.4	5.7	1108	997	195
		260	32.9	8.6	1606	1445	188
		350	33.4	11.7	2135	1922	183
		450	33.9	15.3	2695	2426	177
		700	35.2	24.6	4078	3670	166
		1250	37.6	47.0	6920	6228	147
BXRC-35E2000-C-8x	80	250	32.5	8.1	1582	1424	195
		375	33.0	12.4	2315	2083	187
		500	33.4	16.7	3050	2745	182
		630	33.9	21.4	3777	3400	177
		1000	35.2	35.2	5826	5243	165
		1750	37.5	65.7	9710	8739	148
BXRC-35E2000-D-8x	80	200	30.0	6.0	1167	1050	195
		300	30.4	9.1	1706	1536	187
		400	30.9	12.3	2249	2024	182
		500	31.3	15.6	2764	2488	177
		800	32.5	26.0	4295	3866	165
		1250	34.1	42.7	6467	5821	152
BXRC-35G2000-B-8x	90	175	32.4	5.7	910	819	160
		260	32.9	8.6	1320	1188	154
		350	33.4	11.7	1755	1579	150
		450	33.9	15.3	2215	1993	145
		700	35.2	24.6	3352	3016	136
		1250	37.6	47.0	5687	5118	121
BXRC-35G2000-C-8x	90	250	32.5	8.1	1300	1170	160
		375	33.0	12.4	1902	1712	154
		500	33.4	16.7	2507	2256	150
		630	33.9	21.4	3104	2794	145
		1000	35.2	35.2	4788	4309	136
		1750	37.5	65.7	7980	7182	121
BXRC-35G2000-D-8x	90	200	30.0	6.0	959	863	160
		300	30.4	9.1	1402	1262	154
		400	30.9	12.3	1848	1663	150
		500	31.3	15.6	2272	2044	145
		800	32.5	26.0	3530	3177	136
		1250	34.1	42.7	5315	4784	125

Notes for Table 3:

1. Alternate drive currents in Table 3 are provided for reference only and are not a guarantee of performance.
2. Bridgelux maintains a $\pm 7\%$ tolerance on flux measurements.
3. Typical stabilized DC performance values are provided as reference only and are not a guarantee of performance.

Performance at Commonly Used Drive Currents

Table 3: Product Performance at Commonly Used Drive Currents (Continued)

Part Number	CRI	Drive Current ¹ (mA)	Typical V _f T _c = 25°C (V)	Typical Power T _c = 25°C (W)	Typical Flux ² T _c = 25°C (lm)	Typical DC Flux ³ T _c = 85°C (lm)	Typical Efficacy T _c = 25°C (lm/W)
BXRC-40C2001-B-8x	70	175	32.4	5.7	1165	1048	205
		260	32.9	8.6	1689	1520	197
		350	33.4	11.7	2246	2021	192
		450	33.9	15.3	2834	2551	186
		700	35.2	24.6	4289	3860	174
		1250	37.6	47.0	7278	6550	155
BXRC-40C2001-C-8x	70	250	32.5	8.1	1664	1498	205
		375	33.0	12.4	2434	2191	197
		500	33.4	16.7	3208	2887	192
		630	33.9	21.4	3973	3575	186
		1000	35.2	35.2	6127	5514	174
		1750	37.5	65.7	10212	9191	155
BXRC-40C2001-D-8x	70	200	30.0	6.0	1227	1104	205
		300	30.4	9.1	1795	1615	197
		400	30.9	12.3	2365	2129	192
		500	31.3	15.6	2907	2616	186
		800	32.5	26.0	4517	4066	174
		1250	34.1	42.7	6802	6122	159
BXRC-40E2000-B-8x	80	175	32.4	5.7	1114	1003	196
		260	32.9	8.6	1615	1453	189
		350	33.4	11.7	2147	1933	184
		450	33.9	15.3	2711	2439	178
		700	35.2	24.6	4102	3691	167
		1250	37.6	47.0	6960	6264	148
BXRC-40E2000-C-8x	80	250	32.5	8.1	1591	1432	196
		375	33.0	12.4	2328	2095	188
		500	33.4	16.7	3068	2761	184
		630	33.9	21.4	3799	3419	178
		1000	35.2	35.2	5859	5273	166
		1750	37.5	65.7	9765	8789	149
BXRC-40E2000-D-8x	80	200	30.0	6.0	1173	1056	196
		300	30.4	9.1	1716	1545	188
		400	30.9	12.3	2262	2035	183
		500	31.3	15.6	2780	2502	178
		800	32.5	26.0	4320	3888	166
		1250	34.1	42.7	6505	5854	152
BXRC-40G2000-B-8x	90	175	32.4	5.7	929	836	164
		260	32.9	8.6	1347	1213	157
		350	33.4	11.7	1792	1612	153
		450	33.9	15.3	2261	2035	148
		700	35.2	24.6	3422	3080	139
		1250	37.6	47.0	5806	5226	124

Notes for Table 3:

1. Alternate drive currents in Table 3 are provided for reference only and are not a guarantee of performance.
2. Bridgelux maintains a ± 7% tolerance on flux measurements.
3. Typical stabilized DC performance values are provided as reference only and are not a guarantee of performance.

Performance at Commonly Used Drive Currents

Table 3: Product Performance at Commonly Used Drive Currents (Continued)

Part Number	CRI	Drive Current ¹ (mA)	Typical V _f T _c = 25°C (V)	Typical Power T _c = 25°C (W)	Typical Flux ² T _c = 25°C (lm)	Typical DC Flux ³ T _c = 85°C (lm)	Typical Efficacy T _c = 25°C (lm/W)
BXRC-40G2000-C-8x	90	250	32.5	8.1	1328	1195	164
		375	33.0	12.4	1942	1748	157
		500	33.4	16.7	2559	2303	153
		630	33.9	21.4	3170	2853	148
		1000	35.2	35.2	4888	4400	139
		1750	37.5	65.7	8147	7332	124
BXRC-40G2000-D-8x	90	200	30.0	6.0	979	881	163
		300	30.4	9.1	1432	1289	157
		400	30.9	12.3	1887	1698	153
		500	31.3	15.6	2319	2087	148
		800	32.5	26.0	3604	3244	139
		1250	34.1	42.7	5427	4884	127
BXRC-50C2001-B-8x	70	175	32.4	5.7	1171	1054	206
		260	32.9	8.6	1698	1528	198
		350	33.4	11.7	2258	2032	193
		450	33.9	15.3	2850	2565	187
		700	35.2	24.6	4312	3881	175
		1250	37.6	47.0	7318	6586	156
BXRC-50C2001-C-8x	70	250	32.5	8.1	1673	1506	206
		375	33.0	12.4	2448	2203	198
		500	33.4	16.7	3225	2903	193
		630	33.9	21.4	3994	3595	187
		1000	35.2	35.2	6161	5545	175
		1750	37.5	65.7	10268	9241	156
BXRC-50C2001-D-8x	70	200	30.0	6.0	1234	1110	206
		300	30.4	9.1	1805	1624	198
		400	30.9	12.3	2378	2140	193
		500	31.3	15.6	2923	2631	187
		800	32.5	26.0	4542	4088	175
		1250	34.1	42.7	6839	6155	160
BXRC-50E2001-B-8x	80	175	32.4	5.7	1127	1014	198
		260	32.9	8.6	1633	1470	191
		350	33.4	11.7	2172	1955	186
		450	33.9	15.3	2741	2467	180
		700	35.2	24.6	4148	3734	168
		1250	37.6	47.0	7039	6335	150
BXRC-50E2001-C-8x	80	250	32.5	8.1	1610	1449	198
		375	33.0	12.4	2355	2119	190
		500	33.4	16.7	3103	2792	186
		630	33.9	21.4	3842	3458	180
		1000	35.2	35.2	5926	5334	168
		1750	37.5	65.7	9877	8889	150

Notes for Table 3:

1. Alternate drive currents in Table 3 are provided for reference only and are not a guarantee of performance.
2. Bridgelux maintains a ± 7% tolerance on flux measurements.
3. Typical stabilized DC performance values are provided as reference only and are not a guarantee of performance.

Performance at Commonly Used Drive Currents

Table 3: Product Performance at Commonly Used Drive Currents (Continued)

Part Number	CRI	Drive Current ¹ (mA)	Typical V _f T _c = 25°C (V)	Typical Power T _c = 25°C (W)	Typical Flux ² T _c = 25°C (lm)	Typical DC Flux ³ T _c = 85°C (lm)	Typical Efficacy T _c = 25°C (lm/W)
BXRC-50E2001-D-8x	80	200	30.0	6.0	1187	1068	198
		300	30.4	9.1	1736	1562	190
		400	30.9	12.3	2287	2059	185
		500	31.3	15.6	2812	2530	180
		800	32.5	26.0	4369	3932	168
		1250	34.1	42.7	6579	5921	154
BXRC-50G2001-B-8x	90	175	32.4	5.7	974	877	172
		260	32.9	8.6	1412	1271	165
		350	33.4	11.7	1877	1690	161
		450	33.9	15.3	2370	2133	155
		700	35.2	24.6	3586	3227	146
		1250	37.6	47.0	6085	5476	129
BXRC-50G2001-C-8x	90	250	32.5	8.1	1391	1252	171
		375	33.0	12.4	2035	1832	165
		500	33.4	16.7	2682	2414	160
		630	33.9	21.4	3321	2989	155
		1000	35.2	35.2	5123	4610	145
		1750	37.5	65.7	8538	7684	130
BXRC-50G2001-D-8x	90	200	30.0	6.0	1026	923	171
		300	30.4	9.1	1500	1350	164
		400	30.9	12.3	1977	1780	160
		500	31.3	15.6	2430	2187	155
		800	32.5	26.0	3777	3399	145
		1250	34.1	42.7	5687	5118	133
BXRC-57C2001-B-8x	70	175	32.4	5.7	1139	1026	201
		260	32.9	8.6	1652	1487	193
		350	33.4	11.7	2196	1977	188
		450	33.9	15.3	2772	2495	182
		700	35.2	24.6	4195	3776	170
		1250	37.6	47.0	7119	6407	151
BXRC-57C2001-C-8x	70	250	32.5	8.1	1628	1465	200
		375	33.0	12.4	2381	2143	193
		500	33.4	16.7	3138	2824	188
		630	33.9	21.4	3886	3497	182
		1000	35.2	35.2	5993	5394	170
		1750	37.5	65.7	9989	8990	152
BXRC-57C2001-D-8x	70	200	30.0	6.0	1200	1080	200
		300	30.4	9.1	1755	1580	192
		400	30.9	12.3	2313	2082	187
		500	31.3	15.6	2843	2559	182
		800	32.5	26.0	4419	3977	170
		1250	34.1	42.7	6653	5988	156

Notes for Table 3:

1. Alternate drive currents in Table 3 are provided for reference only and are not a guarantee of performance.
2. Bridgelux maintains a ± 7% tolerance on flux measurements.
3. Typical stabilized DC performance values are provided as reference only and are not a guarantee of performance.

Performance at Commonly Used Drive Currents

Table 3: Product Performance at Commonly Used Drive Currents (Continued)

Part Number	CRI	Drive Current ¹ (mA)	Typical V_f $T_c = 25^\circ\text{C}$ (V)	Typical Power $T_c = 25^\circ\text{C}$ (W)	Typical Flux ² $T_c = 25^\circ\text{C}$ (lm)	Typical DC Flux ³ $T_c = 85^\circ\text{C}$ (lm)	Typical Efficacy $T_c = 25^\circ\text{C}$ (lm/W)
BXRC-57E2001-B-8x	80	175	32.4	5.7	1082	974	191
		260	32.9	8.6	1569	1412	183
		350	33.4	11.7	2086	1877	178
		450	33.9	15.3	2633	2370	172
		700	35.2	24.6	3984	3586	162
		1250	37.6	47.0	6761	6085	144
BXRC-57E2001-C-8x	80	250	32.5	8.1	1546	1391	190
		375	33.0	12.4	2261	2035	183
		500	33.4	16.7	2980	2682	178
		630	33.9	21.4	3691	3321	173
		1000	35.2	35.2	5692	5123	162
		1750	37.5	65.7	9486	8538	144
BXRC-57E2001-D-8x	80	200	30.0	6.0	1140	1026	190
		300	30.4	9.1	1667	1500	183
		400	30.9	12.3	2197	1977	178
		500	31.3	15.6	2700	2430	173
		800	32.5	26.0	4196	3777	161
		1250	34.1	42.7	6319	5687	148
BXRC-65C2001-B-8x	70	175	32.4	5.7	1139	1026	201
		260	32.9	8.6	1652	1487	193
		350	33.4	11.7	2196	1977	188
		450	33.9	15.3	2772	2495	182
		700	35.2	24.6	4195	3776	170
		1250	37.6	47.0	7119	6407	151
BXRC-65C2001-C-8x	70	250	32.5	8.1	1628	1465	200
		375	33.0	12.4	2381	2143	193
		500	33.4	16.7	3138	2824	188
		630	33.9	21.4	3886	3497	182
		1000	35.2	35.2	5993	5394	170
		1750	37.5	65.7	9989	8990	152
BXRC-65C2001-D-8x	70	200	30.0	6.0	1200	1080	200
		300	30.4	9.1	1755	1580	192
		400	30.9	12.3	2313	2082	187
		500	31.3	15.6	2843	2559	182
		800	32.5	26.0	4419	3977	170
		1250	34.1	42.7	6653	5988	156
BXRC-65E2001-B-8x	80	175	32.4	5.7	1095	985	193
		260	32.9	8.6	1587	1428	185
		350	33.4	11.7	2111	1899	181
		450	33.9	15.3	2664	2398	175
		700	35.2	24.6	4031	3628	164
		1250	37.6	47.0	6840	6156	146

Notes for Table 3:

1. Alternate drive currents in Table 3 are provided for reference only and are not a guarantee of performance.
2. Bridgelux maintains a $\pm 7\%$ tolerance on flux measurements.
3. Typical stabilized DC performance values are provided as reference only and are not a guarantee of performance.

Performance at Commonly Used Drive Currents

Table 3: Product Performance at Commonly Used Drive Currents (Continued)

Part Number	CRI	Drive Current ¹ (mA)	Typical V_f $T_c = 25^\circ\text{C}$ (V)	Typical Power $T_c = 25^\circ\text{C}$ (W)	Typical Flux ² $T_c = 25^\circ\text{C}$ (lm)	Typical DC Flux ³ $T_c = 85^\circ\text{C}$ (lm)	Typical Efficacy $T_c = 25^\circ\text{C}$ (lm/W)
BXRC-65E2001-C-8x	80	250	32.5	8.1	1564	1408	193
		375	33.0	12.4	2288	2059	185
		500	33.4	16.7	3015	2714	180
		630	33.9	21.4	3734	3361	175
		1000	35.2	35.2	5759	5183	164
		1750	37.5	65.7	9598	8638	146
BXRC-65E2001-D-8x	80	200	30.0	6.0	1153	1038	192
		300	30.4	9.1	1687	1518	185
		400	30.9	12.3	2223	2001	180
		500	31.3	15.6	2732	2459	175
		800	32.5	26.0	4246	3821	163
		1250	34.1	42.7	6393	5754	150

Notes for Table 3:

1. Alternate drive currents in Table 3 are provided for reference only and are not a guarantee of performance.
2. Bridgelux maintains a $\pm 7\%$ tolerance on flux measurements.
3. Typical stabilized DC performance values are provided as reference only and are not a guarantee of performance.

Electrical Characteristics

Table 4: Electrical Characteristics

Part Number	Drive Current (mA)	Forward Voltage Pulsed, $T_c = 25^\circ\text{C}$ (V) ^{1, 2, 3, 8}			Typical Coefficient of Forward Voltage ⁴ $\Delta V_f / \Delta T_c$ (mV/ $^\circ\text{C}$)	Typical Thermal Resistance Junction to Case ^{5,6} R_{j-c} ($^\circ\text{C}/\text{W}$)	Driver Selection Voltages ⁷ (V)	
		Minimum	Typical	Maximum			V_f Min. Hot $T_c = 105^\circ\text{C}$ (V)	V_f Max. Cold $T_c = -40^\circ\text{C}$ (V)
BXRC-xxx200x-B-8x	350	30.9	33.4	35.9	-10.77	0.22	30.0	36.6
	1250	34.8	37.6	40.4	-12.13	0.34	33.8	41.2
BXRC-xxx200x-C-8x	500	30.9	33.4	35.9	-10.77	0.19	30.0	36.6
	1750	34.7	37.5	40.3	-12.10	0.29	33.7	41.1
BXRC-xxx200x-D-8x	400	28.6	30.9	33.2	-9.97	0.25	27.8	33.9
	1250	31.5	34.1	36.7	-11.00	0.38	30.7	37.4

Notes for Table 4:

- Parts are tested in pulsed conditions, $T_c = 25^\circ\text{C}$. Pulse width is 10ms.
- Voltage minimum and maximum are provided for reference only and are not a guarantee of performance.
- Bridgelux maintains a tester tolerance of $\pm 0.10\text{V}$ on forward voltage measurements.
- Typical coefficient of forward voltage tolerance is $\pm 0.1\text{mV}$ for nominal current.
- Thermal resistance values are based from test data of a 3000K 80 CRI product.
- Thermal resistance value was calculated using total electrical input power; optical power was not subtracted from input power. The thermal interface material used during testing is not included in the thermal resistance value.
- V_f min hot and max cold values are provided as reference only and are not guaranteed by test. These values are provided to aid in driver design and selection over the operating range of the product.
- This product has been designed and manufactured per IEC 62031:2014. This product has passed dielectric withstand voltage testing at 1140 V. The working voltage designated for the insulation is 70V d.c. The maximum allowable voltage across the array must be determined in the end product application.

Eye Safety

Table 5: Eye Safety Risk Group (RG) Classifications

Part Number	Drive Current (mA)	CCT			
		2700K/3000K	4000K ²	5000K ³	6500K ⁴
BXRC-xxx200x-B-8x	800	RG1	RG1	RG1	RG1
	1110	RG1	RG1	RG1	RG2
	1250	RG1	RG1	RG2	RG2
BXRC-xxx200x-C-8x	800	RG1	RG1	RG1	RG1
	1110	RG1	RG1	RG1	RG2
	1470	RG1	RG1	RG2	RG2
	1750	RG1	RG2	RG2	RG2
BXRC-xxx200x-D-8x	865	RG1	RG1	RG1	RG1
	1195	RG1	RG1	RG1	RG2
	1250	RG1	RG1	RG2	RG2

Notes for Table 5:

1. Eye safety classification for the use of Bridgelux V Series LED arrays is in accordance with specification IEC/TR 62778: Application of IEC 62471 for the assessment of blue light hazard to light sources and luminaires.
2. For products classified as RG2 at 4000K, Ethr- 1980 lx.
3. For products classified as RG2 at 5000K Ethr- 1530 lx.
4. For products classified as RG2 at 6500K, Ethr- 1170 lx.
5. Please contact your Bridgelux sales representative for Ethr values at specific drive currents and CCTs not listed.

Absolute Maximum Ratings

Table 6: Maximum Ratings

Parameter	Maximum Rating		
LED Junction Temperature (T _j)	150°C		
Storage Temperature	-40°C to +105°C		
Operating Case Temperature ¹ (T _c)	105°C		
Soldering Temperature ²	300°C or lower for a maximum of 6 seconds		
	BXRC-xxx200x-B-8x	BXRC-xxx200x-C-8x	BXRC-xxx200x-D-8x
Maximum Drive Current ³	1250 mA	1750 mA	1250 mA
Maximum Peak Pulsed Drive Current ⁴	1400 mA	1960 mA	1400 mA
Maximum Reverse Voltage ⁵	-60V	-60V	-55V

Notes for Table 6:

1. For IEC 62717 requirement, please consult your Bridgelux sales representative.
2. Refer to Bridgelux Application Note AN31: Assembly Considerations for Bridgelux Vero LED Arrays.
3. Arrays may be driven at higher currents however lumen maintenance may be reduced and warranty will not apply.
4. Bridgelux recommends a maximum duty cycle of 10% and pulse width of 20 ms when operating LED Arrays at maximum peak pulsed current specified. Maximum peak pulsed currents indicate values where LED Arrays can be driven without catastrophic failures.
5. Light emitting diodes are not designed to be driven in reverse voltage and will not produce light under this condition. Maximum rating provided for reference only.

Performance Curves

Figure 1: Vero 13B Drive Current vs. Voltage

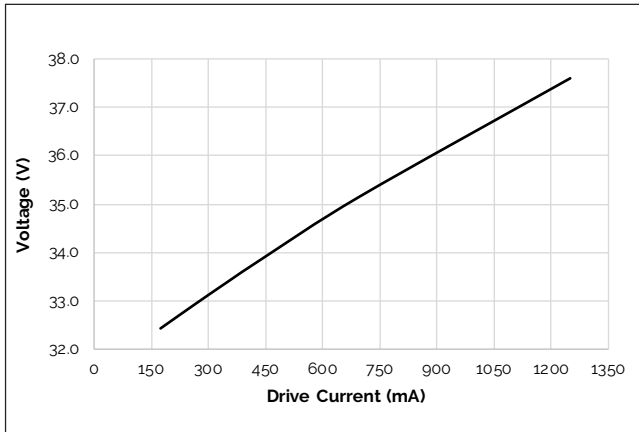

Figure 2: Vero 13C Drive Current vs. Voltage

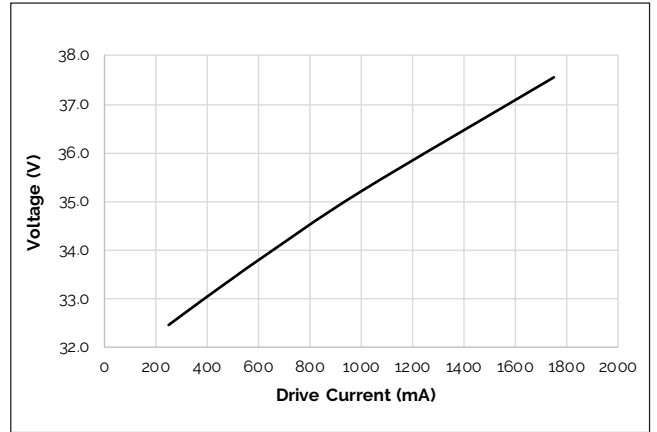

Figure 3: Vero 13D Drive Current vs. Voltage

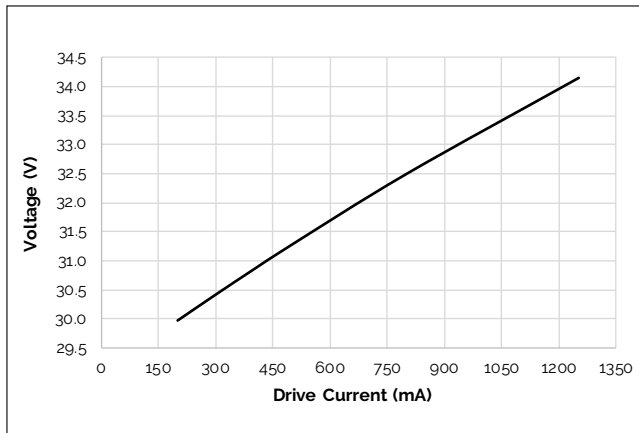

Figure 4: Vero 13B Typical Relative Flux vs. Current

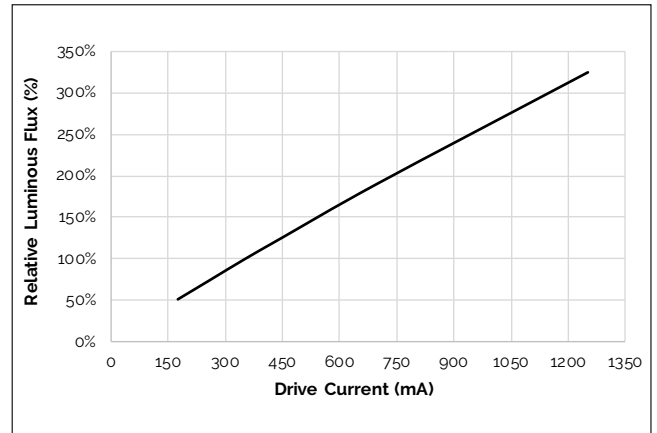

Figure 5: Vero 13C Typical Relative Flux vs. Current

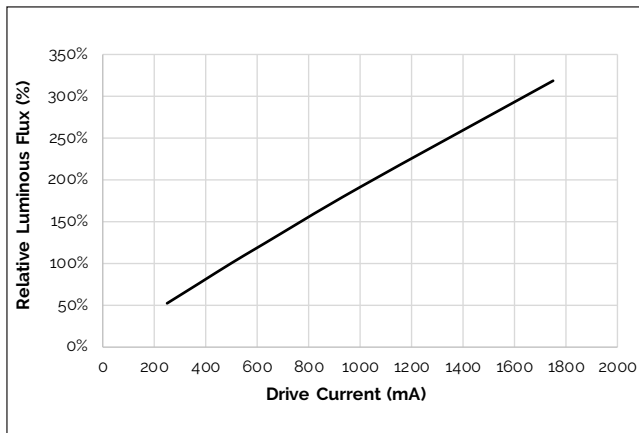
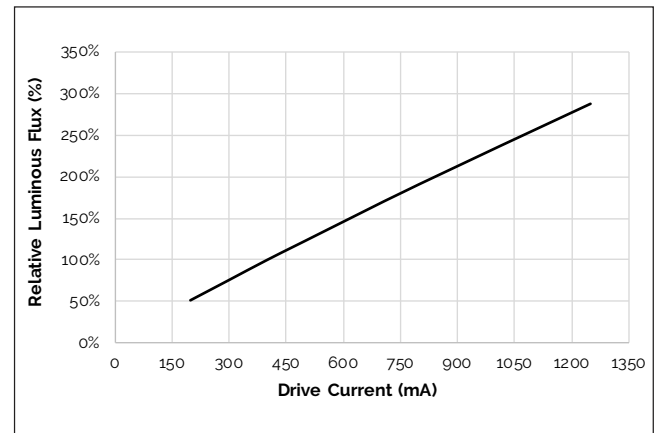

Figure 6 Vero 13D Typical Relative Flux vs. Current



Note for Figure 1-6:

1. Bridgelux does not recommend driving high power LEDs at low currents. Doing so may produce unpredictable results. Pulse width modulation (PWM) is recommended for dimming effects.
2. Products tested under pulsed condition (10ms pulse width) at nominal test current where T_j (junction temperature) = T_c (case temperature) = 25°C.

Performance Curves

Figure 7: Typical DC Flux vs. Case Temperature

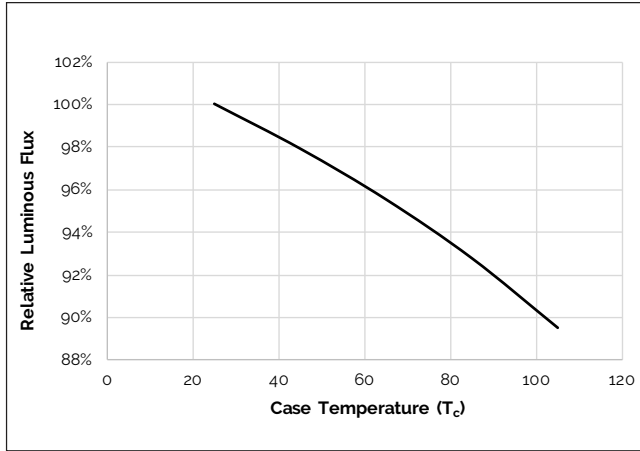

Figure 8: Typical DC ccy Shift vs. Case Temperature

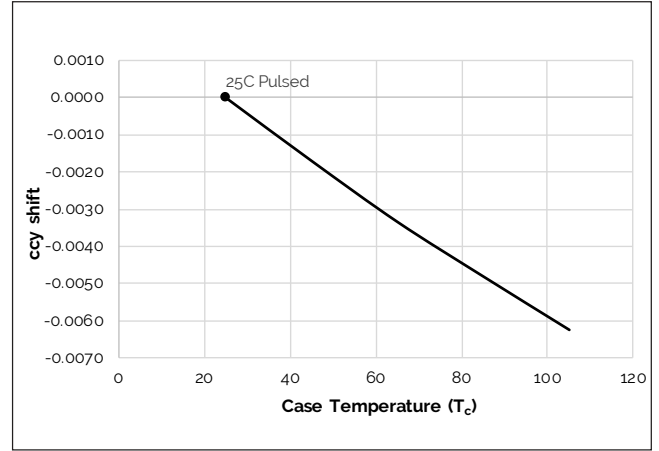
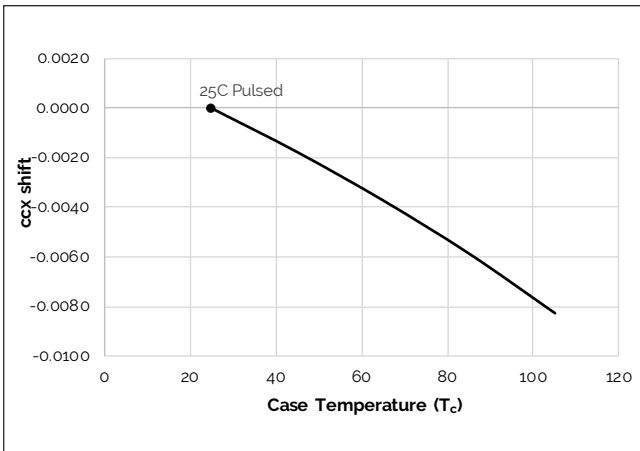

Figure 9: Typical DC ccx Shift vs. Case Temperature



Notes for Figures 7-9:

1. Characteristics shown for warm white based on 3000K and 80 CRI.
2. Characteristics shown for neutral white based on 4000K and 80 CRI.
3. Characteristics shown for cool white based on 5000K and 70 CRI.
4. For other color SKUs, the shift in color will vary. Please contact your Bridgelux Sales Representative for more information.

Typical Radiation Pattern

Figure 10: Typical Spatial Radiation Pattern

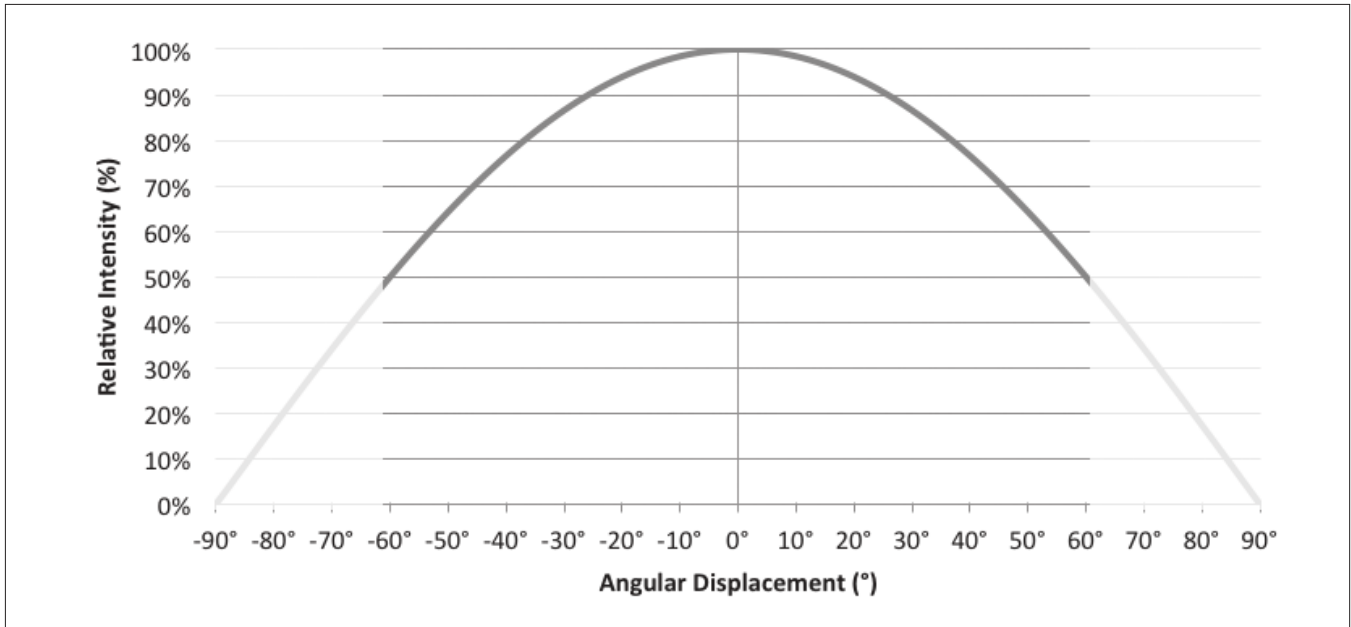

Note for Figure 10:

1. Typical viewing angle is 120°.
2. The viewing angle is defined as the off axis angle from the centerline where intensity is ½ of the peak value.

Figure 11: Typical Polar Radiation Pattern

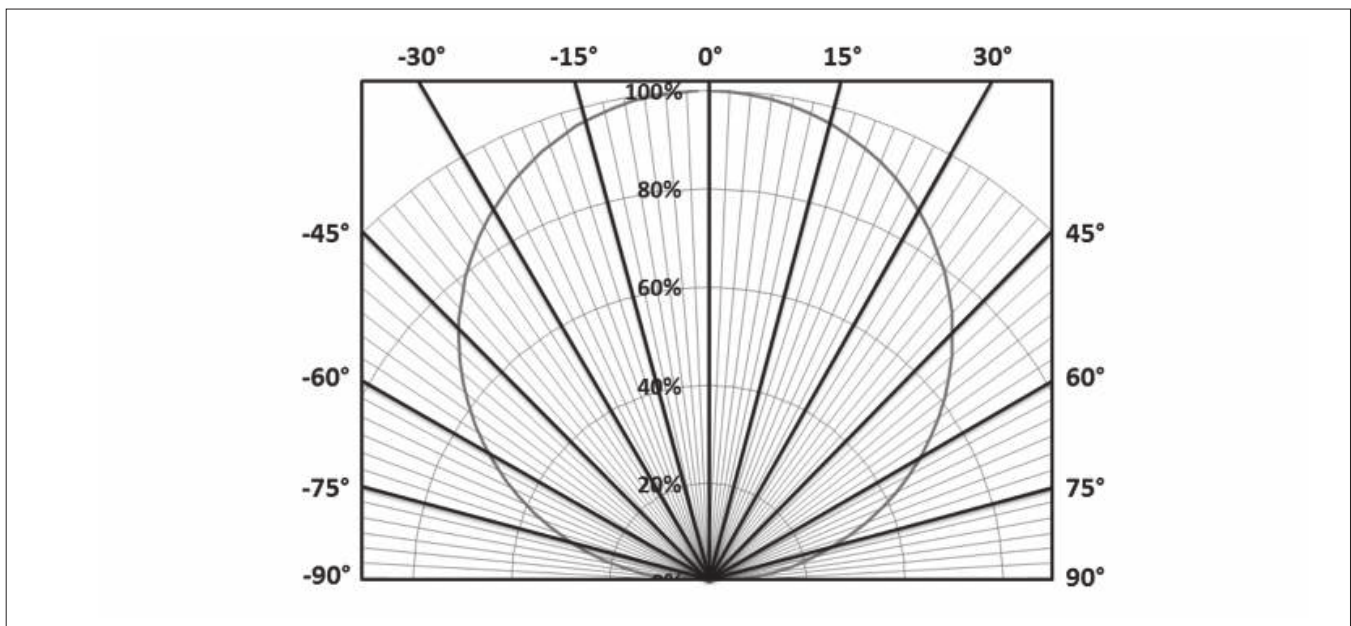

Typical Color Spectrum

Figure 12: Typical Color Spectrum

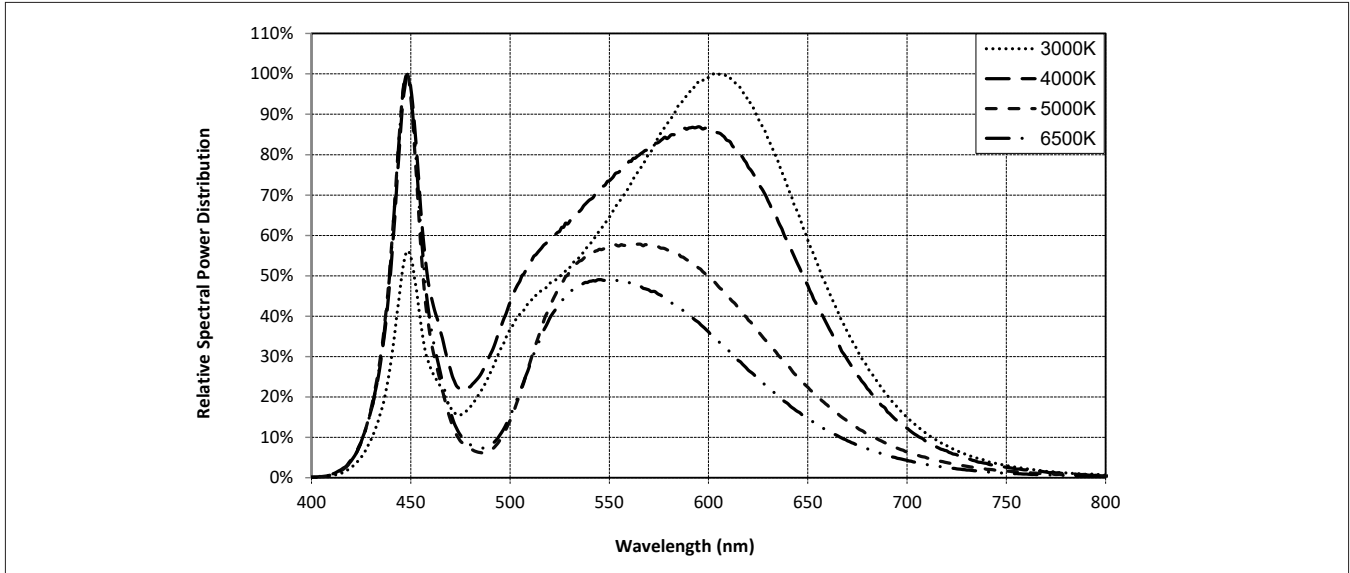

Note for Figure 12:

1. Color spectra measured at nominal current for $T_j = T_c = 25^\circ\text{C}$.
2. Color spectra shown is 3000K and 80 CRI.
3. Color spectra shown is 4000K and 80 CRI.
4. Color spectra shown is 5000K and 70 CRI.
4. Color spectra shown is 6500K and 70 CRI.

Mechanical Dimensions

Figure 13: Drawing for Vero 13 LED Array

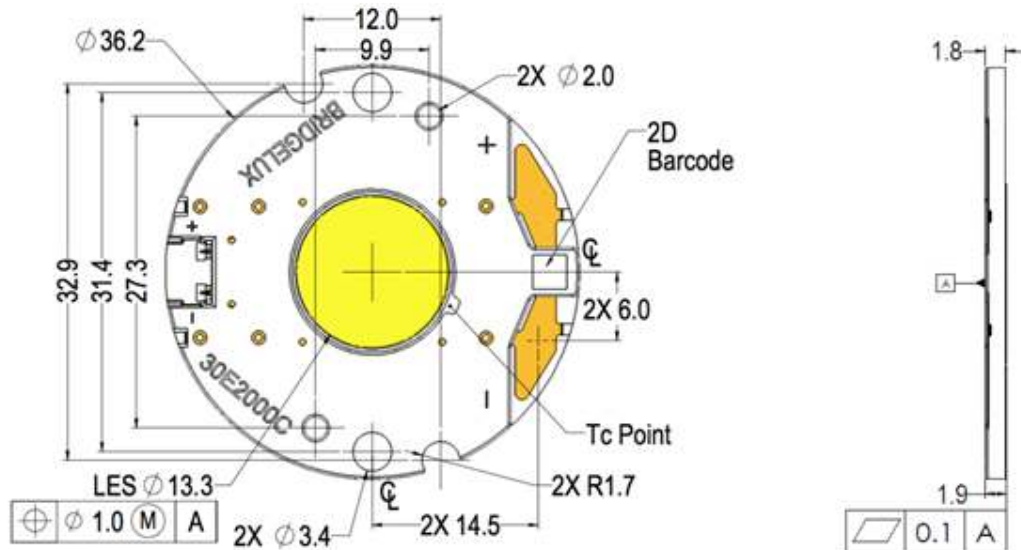

Notes for Figure 13:

1. Drawings are not to scale.
2. Drawing dimensions are in millimeters.
3. Unless otherwise specified, tolerances are $\pm 0.1\text{mm}$.
4. Mounting holes (2X) are for M2.5 screws.
5. Bridgelux recommends two tapped holes for mounting screws with $31.4 \pm 0.10\text{mm}$ center-to-center spacing.
6. Screws with flat shoulders (pan, dome, button, round, truss, mushroom) provide optimal torque control. Do NOT use flat, countersink, or raised head screws.
7. Solder pads and connector port are labeled "+" and "-" to denote positive and negative, respectively.
8. It is not necessary to provide electrical connections to both the solder pads and the connector port. Either set may be used depending on application specific design requirements.
9. Refer to Application Notes AN30 and AN31 for product handling, mounting and heat sink recommendations.
10. The optical center of the LED Array is nominally defined by the mechanical center of the array to a tolerance of $\pm 0.2\text{mm}$.
11. Bridgelux maintains a flatness of 0.10mm across the mounting surface of the array.

Color Binning Information

Figure 14: Warm and Neutral White Test Bins in xy Color Space

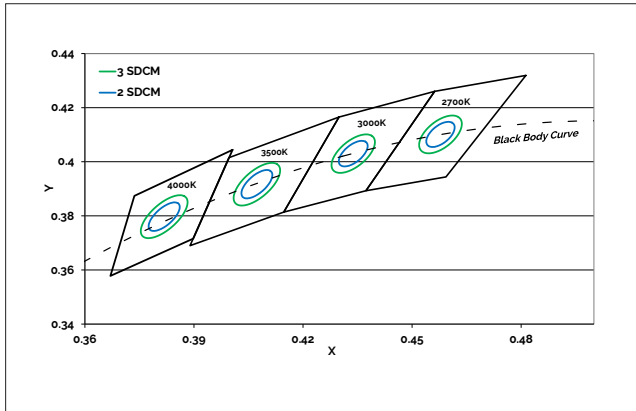

Note: Pulsed Test Conditions, $T_c = 25^\circ\text{C}$

Figure 15: Cool White Test Bins in xy Color Space

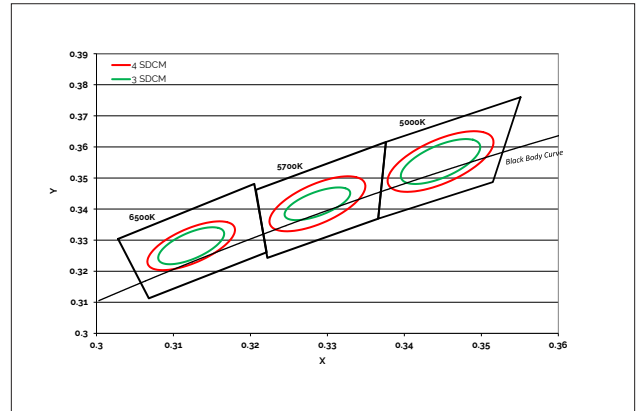

Note: Pulsed Test Conditions, $T_c = 25^\circ\text{C}$

Table 7: Warm and Neutral White xy Bin Coordinates and Associated Typical CCT

Bin Code	2700K	3000K	3500K	4000K
ANSI Bin (for reference only)	(2580K - 2870K)	(2870K - 3220K)	(3220K - 3710K)	(3710K - 4260K)
83 (3 SDCM)	(2651K - 2794K)	(2968K - 3136K)	(3369K - 3586K)	(3851K - 4130K)
82 (2 SDCM)	(2674K - 2769K)	(2995K - 3107K)	(3404K - 3548K)	(3895K - 4081K)
Center Point (x,y)	(0.4578, 0.4101)	(0.4338, 0.403)	(0.4073, 0.3917)	(0.3818, 0.3797)

Table 8: Cool White xy Bin Coordinates and Associated Typical CCT (product is hot targeted to $T_c = 85^\circ\text{C}$)

Bin Code	5000K	5700K	6500K
ANSI Bin (for reference only)	(4745K - 5311K)	(5312K - 6022K)	(6022K - 7042K)
84 (4 SDCM)	(4801K - 5282K)	(5829K - 5481K)	(6270K - 6765K)
83 (3 SDCM)	(4835K - 5215K)	(5490K - 5820K)	(6250K - 6745K)
Center Point (x,y)	(0.3447, 0.3553)	(0.3287, 0.3417)	(0.3123, 0.3282)

Packaging and Labeling

Figure 16: Drawing for Vero 13 Packaging Tray

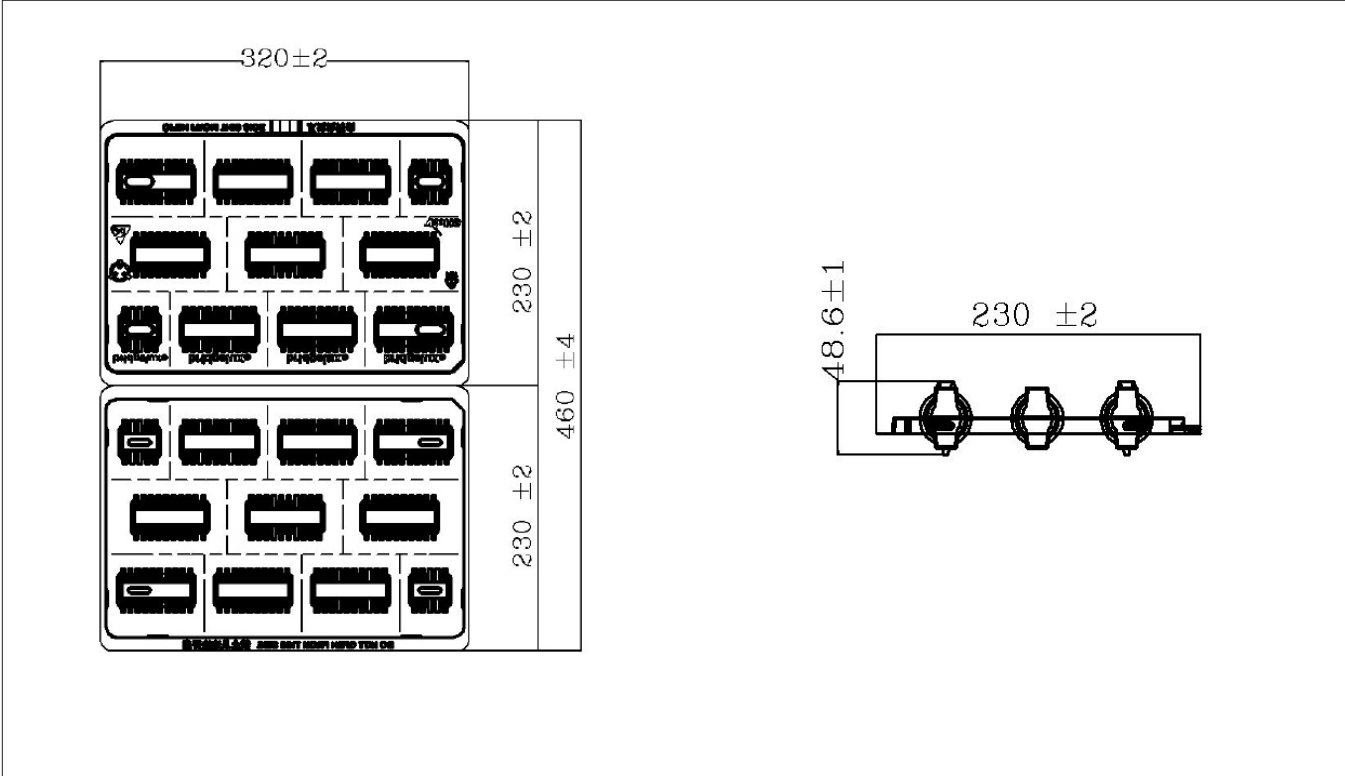

- Notes for Figure 16:
- 1. Dimensions are in millimeters.
 - 2. Drawings are not to scale.

Packaging and Labeling

Figure 17: Vero Series Packaging and Labeling

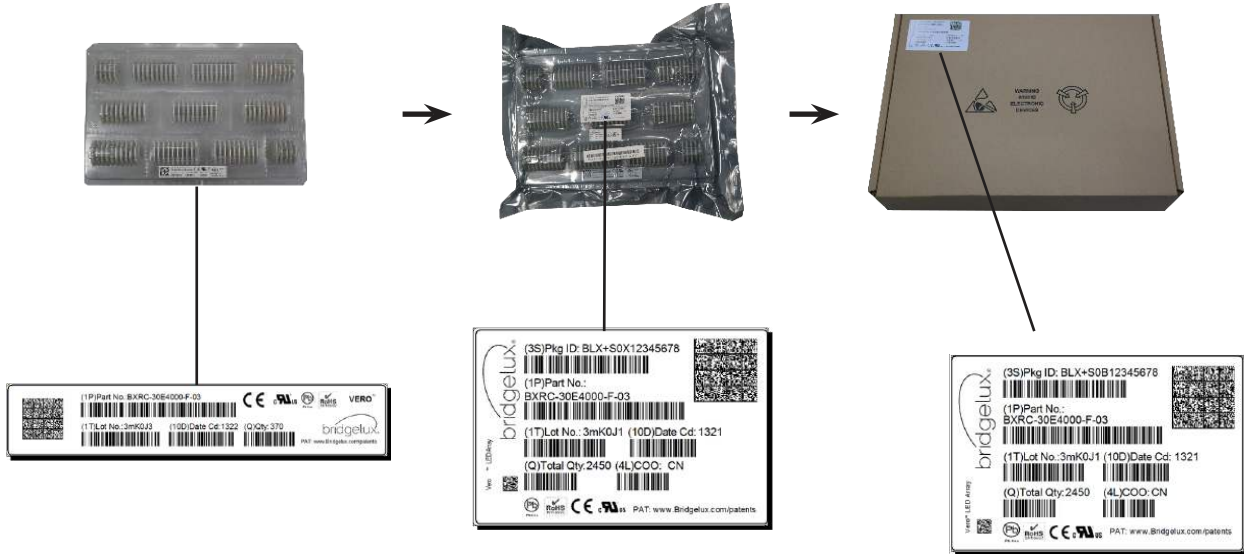

Notes for Figure 17:

1. Each tray holds 100 COBs.
2. Each tray is vacuum sealed in an anti-static bag and placed in its own box.
3. Each tray, bag and box is to be labeled as shown above.

Figure 18: Gen. 8 Product Labeling

Bridgelux COB arrays have laser markings on the back side of the substrate to help with product identification. In addition to the product identification markings, Bridgelux COB arrays also contain markings for internal Bridgelux manufacturing use only. The image below shows which markings are for customer use and which ones are for Bridgelux internal use only. The Bridgelux internal manufacturing markings are subject to change without notice, however these will not impact the form, function or performance of the COB array.



Customer Use- 2D Barcode
Scannable barcode provides product part number and other Bridgelux internal production information.

Customer Use- Product part number

30E2000C 83 2F

Customer Use- V, Bin Code included to enable greater luminaire design flexibility. Refer to ANG2 for bin code definitions.

Design Resources

Application Notes

Bridgelux has developed a comprehensive set of application notes and design resources to assist customers in successfully designing with the Vero product family of LED array products. For all available application notes visit www.bridgelux.com.

Optical Source Models

Optical source models and ray set files are available for all Bridgelux products. For a list of available formats, visit www.bridgelux.com.

3D CAD Models

Three dimensional CAD models depicting the product outline of all Bridgelux Vero LED arrays are available in both IGS and STEP formats. Please contact your Bridgelux sales representative for assistance.

LM80

LM80 testing has been completed and the LM80 report is now available. Please contact your Bridgelux sales representative for LM-80 report.

Precautions

CAUTION: CHEMICAL EXPOSURE HAZARD

Exposure to some chemicals commonly used in luminaire manufacturing and assembly can cause damage to the LED array. Please consult Bridgelux Application Note AN31 for additional information.

CAUTION: RISK OF BURN

Do not touch the Vero LED array during operation. Allow the array to cool for a sufficient period of time before handling. The Vero LED array may reach elevated temperatures such that could burn skin when touched.

CAUTION

CONTACT WITH LIGHT EMITTING SURFACE (LES)

Avoid any contact with the LES. Do not touch the LES of the LED array or apply stress to the LES (yellow phosphor resin area). Contact may cause damage to the LED array.

Optics and reflectors must not be mounted in contact with the LES (yellow phosphor resin area). Optical devices may be mounted on the top surface of the plastic housing of the Vero LED array. Use the mechanical features of the LED array housing, edges and/or mounting holes to locate and secure optical devices as needed.

Disclaimers

MINOR PRODUCT CHANGE POLICY

The rigorous qualification testing on products offered by Bridgelux provides performance assurance. Slight cosmetic changes that do not affect form, fit, or function may occur as Bridgelux continues product optimization.

STANDARD TEST CONDITIONS

Unless otherwise stated, array testing is performed at the nominal drive current.

About Bridgelux: Bridging Light and Life™

At Bridgelux, we help companies, industries and people experience the power and possibility of light. Since 2002, we've designed LED solutions that are high performing, energy efficient, cost effective and easy to integrate. Our focus is on light's impact on human behavior, delivering products that create better environments, experiences and returns—both experiential and financial. And our patented technology drives new platforms for commercial and industrial luminaires.

For more information about the company, please visit
bridgelux.com
twitter.com/Bridgelux
facebook.com/Bridgelux
youtube.com/user/Bridgelux
linkedin.com/company/bridgelux-inc-_2
WeChat ID: BridgeluxInChina



46430 Fremont Boulevard
Fremont, CA 94538 U.S.A.
Tel (925) 583-8400
www.bridgelux.com

© 2020 Bridgelux, Inc. All rights reserved. Product specifications are subject to change without notice. Bridgelux, the Bridgelux stylized logo design, Vero, V Series and V Series HD are registered trademarks, and Decor Series is a trademark of Bridgelux, Inc. All other trademarks are the property of their respective owners.

Bridgelux Gen 8 Vero 13 Array Series Product Data Sheet DS421 Rev. A (07/2020)