

PMC15

PMC 15 E -1 -□

① ② ③ ④ ⑤



- ① Series name
- ② Output wattage
- ③ UL recognized, TÜV approved, CSA certified : E
- ④ Output voltage combination
- ⑤ Optional *1
C :with Coating
G :Low leakage current

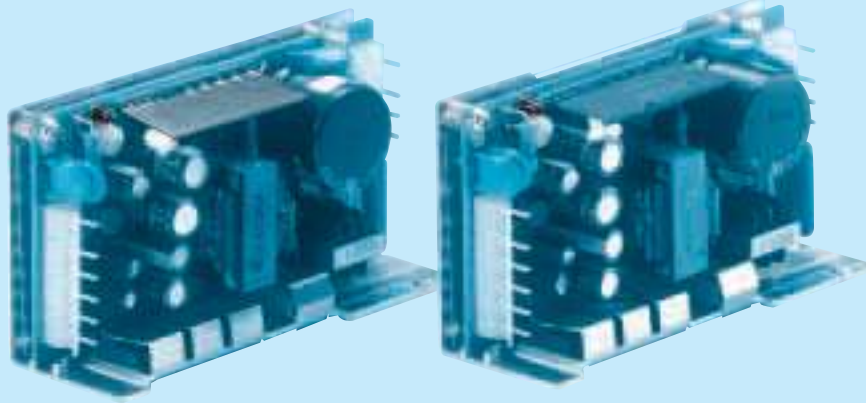

PMC

MODEL		PMC15E-1	PMC15E-2	PMC15E-3
DC OUTPUT	V1	+5V 2.0A	+5V 2.0A	+5V 2.0A
	V2	+12V 0.3A	+15V 0.3A	+12V 0.3A
	V3	-12V 0.2A	-15V 0.2A	-5V 0.2A

SPECIFICATIONS

	MODEL	PMC15E-1			PMC15E-2			PMC15E-3			
INPUT	VOLTAGE[V]	AC85 - 264 1ϕ or DC110 - 370									
	CURRENT[A]	ACIN 100V	0.4typ (Io=100%) Universal Input								
		ACIN 200V	0.2typ (Io=100%) Universal Input								
	FREQUENCY[Hz]	47 - 440 or DC									
	EFFICIENCY[%]	ACIN 100V	65typ (Io=100%)								
	INRUSH CURRENT[A]	ACIN 100V	20typ (Io=100%) (At cold start)								
OUTPUT	VOLTAGE[V]	+5	+12	-12	+5	+15	-15	+5	+12	-5	
	CURRENT[A]	2.0	0.3	0.2	2.0	0.3	0.2	2.0	0.3	0.2	
	MINIMUM CURRENT[A]	0.1	0	0	0.1	0	0	0.1	0	0	
	LINE REGULATION[mV]	20max	48max	48max	20max	60max	60max	20max	48max	20max	
	LOAD REGULATION[mV]	100max	120max	120max	100max	150max	150max	100max	120max	50max	
	RIPPLE[mVp-p]	100max	60max	60max	100max	60max	60max	100max	60max	60max	
	RIPPLE NOISE[mVp-p]	120max	150max	150max	120max	150max	150max	120max	150max	150max	
	TEMPERATURE REGULATION[mV]	0 to +50°C	50max	350max	350max	50max	350max	350max	50max	350max	350max
	START-UP TIME[ms]	100max (ACIN 85V, Io=100%)									
	HOLD-UP TIME[ms]	10typ (ACIN 85V, Io=100%)									
PROTECTION CIRCUIT	OVERCURRENT PROTECTION	Works over 105% of rating and recovers automatically									
	INPUT-OUTPUT	AC3,000V 1minute, Cutoff current = 10mA, DC500V 50MΩmin (At Room Temperature)									
ISOLATION	INPUT-CASE	AC2,000V 1minute, Cutoff current = 10mA, DC500V 50MΩmin (At Room Temperature)									
	OUTPUT-CASE	AC500V 1minute, Cutoff current = 100mA, DC500V 50MΩmin (At Room Temperature)									
	OUTPUT-OUTPUT(V1-V2,V3)	AC100V 1minute, Cutoff current = 100mA, DC100V 10MΩmin (At Room Temperature)									
ENVIRONMENT	OPERATING TEMP.,HUMID.AND ALTITUDE	0 to +65°C, 20 - 90%RH (Non condensing) (Refer to DERATING CURVE), 3,000m (10,000feet) max									
	STORAGE TEMP.,HUMID.AND ALTITUDE	-20 to +75°C, 20 - 90%RH (Non condensing), 9,000m (30,000feet) max									
	VIBRATION	10 - 55Hz, 19.6m/s ² (2G), 3minutes period, 30minutes each along X, Y and Z axis									
	IMPACT	196.1m/s ² (20G), 11ms, once each X, Y and Z axis									
SAFETY AND NOISE REGULATIONS	AGENCY APPROVALS	UL60950-1, CSA C22.2 No.60950-1, EN60950-1, EN50178 Complies with IEC60950-1 and DEN-AN									
	CONDUCTED NOISE	Complies with FCC-B									

*1 Please contact us about safety approvals for the model with option.
* Series/Parallel operation with other model is not possible.

External view

(PIN CONNECTION)

CN1	PIN NO.	INPUT
	1	FG
2	AC (L)	
3	NC	
4	AC (N)	

CN2	PIN NO.	OUTPUT
	1	NC
2	G1	
3	V1	
4	V3	
5	G2	
6	V2	

※V1 is Isolated from V2 and V3.

I/O Connector	Mating Connector	Terminal
CN1	10-31-1048	10-63-3044
CN2	10-31-1068	10-63-3064

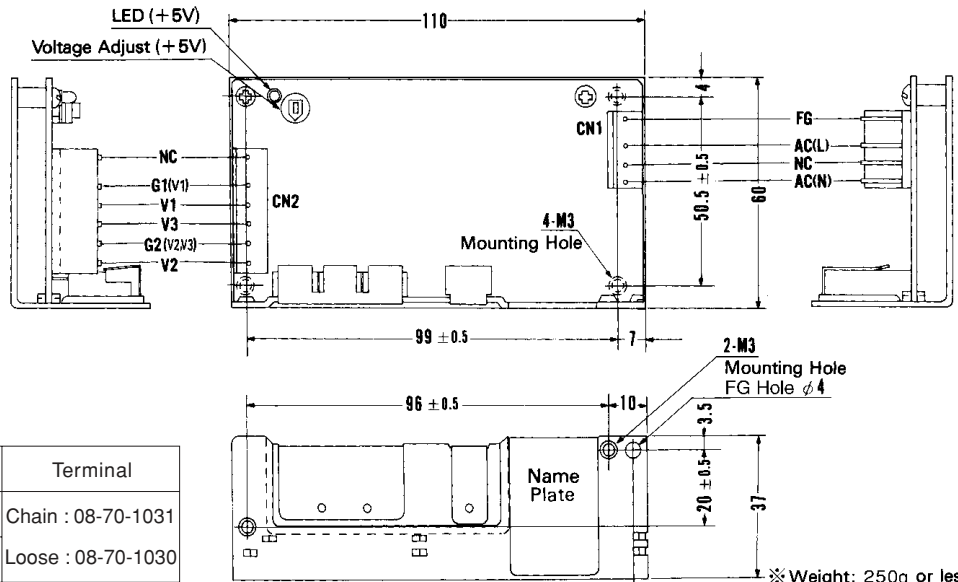

(Mfr : Molex)

※ Weight: 250g or less.
 ※ Tolerance: ±1
 ※ Dimensions in mm.
 ※ Mounting torque : 0.49N·m (5.0 kgf·cm) max

Performance data

■ STATIC CHARACTERISTICS (PMC15E-1)

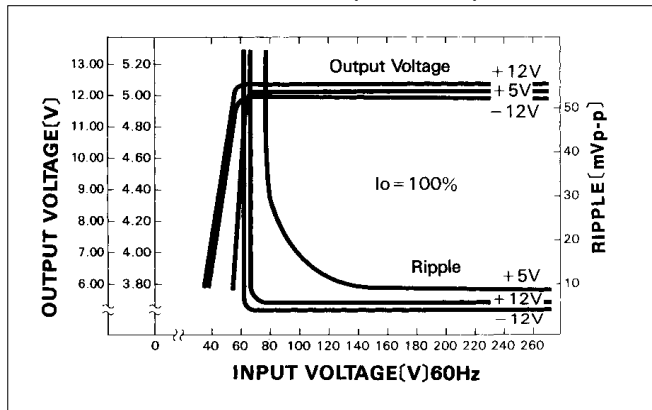

■ RISE TIME & FALL TIME (PMC15E-1)

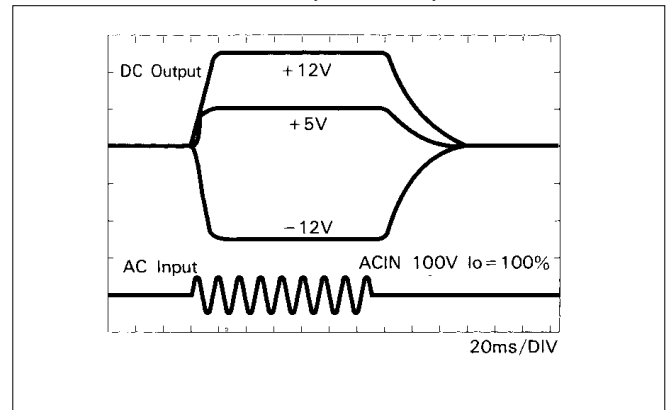

■ OVERCURRENT CHARACTERISTICS (PMC15E-1)

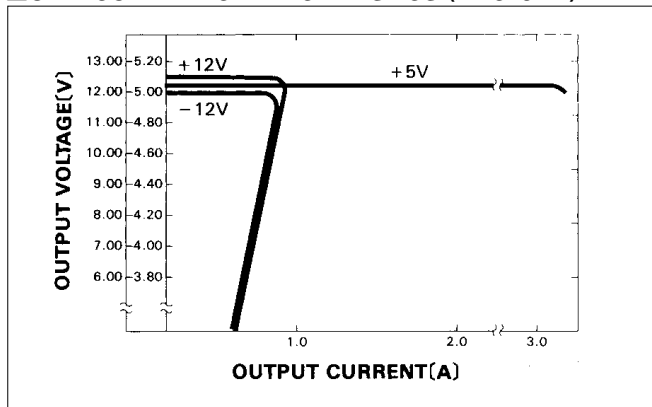

■ DERATING CURVE

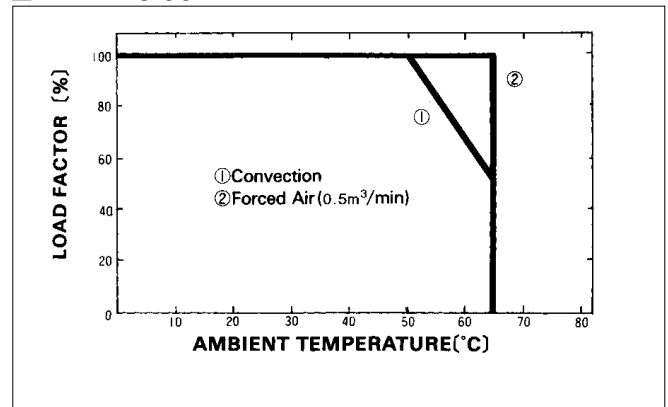

PMC30

PMC 30 E -1 -□

① ② ③ ④ ⑤



- ① Series name
- ② Output wattage
- ③ UL recognized, TÜV approved, CSA certified : E
- ④ Output voltage combination
- ⑤ Optional *1
C :with Coating
G :Low leakage current

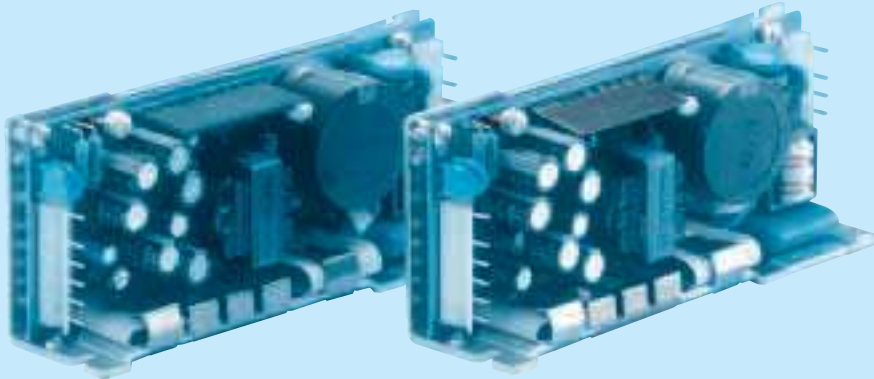

PMC

MODEL	PMC30E-1	PMC30E-2
DC OUTPUT	V1	+5V 3.0A
	V2	+12V 1.2A
	V3	-12V 0.3A

SPECIFICATIONS

	MODEL	PMC30E-1	PMC30E-2				
INPUT	VOLTAGE[V]	AC85 - 264 1φ or DC110 - 370					
	CURRENT[A]	ACIN 100V	0.8typ (Io=100%) Universal Input				
		ACIN 200V	0.4typ (Io=100%) Universal Input				
	FREQUENCY[Hz]	47 - 440 or DC					
	EFFICIENCY[%]	ACIN 100V	65typ (Io=100%)				
	INRUSH CURRENT[A]	ACIN 100V	25typ (Io=100%) (At cold start)				
OUTPUT	VOLTAGE[V]	+5	+12	-12	+5	+15	-15
	CURRENT[A]	3.0	1.2	0.3	3.0	0.7	0.5
	MINIMUM CURRENT[A]	0.3	0	0	0.3	0	0
	LINE REGULATION[mV]	20max	48max	48max	20max	60max	60max
	LOAD REGULATION[mV]	100max	120max	150max	100max	120max	150max
	RIPPLE[mVp-p]	100max	120max	60max	100max	120max	100max
	RIPPLE NOISE[mVp-p]	120max	150max	150max	120max	150max	150max
	TEMPERATURE REGULATION[mV]	0 to +50°C	50max	350max	350max	50max	350max
	START-UP TIME[ms]	100max (ACIN 85V, Io=100%)					
	HOLD-UP TIME[ms]	10typ (ACIN 85V, Io=100%)					
OUTPUT VOLTAGE ADJUSTMENT RANGE[V]	5.00 - 5.25	Fixed	Fixed	5.00 - 5.25	Fixed	Fixed	
OUTPUT VOLTAGE SETTING[V]	—	11.4 to 12.6	-11.4 to -12.6	—	14.25 to 15.75	-14.25 to -15.75	
PROTECTION CIRCUIT	OVERCURRENT PROTECTION	Works over 105% of rating and recovers automatically					
ISOLATION	INPUT-OUTPUT	AC3,000V 1minute, Cutoff current = 10mA, DC500V 50MΩmin (At Room Temperature)					
	INPUT-CASE	AC2,000V 1minute, Cutoff current = 10mA, DC500V 50MΩmin (At Room Temperature)					
	OUTPUT-CASE	AC500V 1minute, Cutoff current = 100mA, DC500V 50MΩmin (At Room Temperature)					
	OUTPUT-OUTPUT(V1-V2,V3)	AC100V 1minute, Cutoff current = 100mA, DC100V 10MΩmin (At Room Temperature)					
ENVIRONMENT	OPERATING TEMP.,HUMID.AND ALTITUDE	0 to +65°C, 20 - 90%RH (Non condensing) (Refer to DERATING CURVE), 3,000m (10,000feet) max					
	STORAGE TEMP.,HUMID.AND ALTITUDE	-20 to +75°C, 20 - 90%RH (Non condensing), 9,000m (30,000feet) max					
	VIBRATION	10 - 55Hz, 19.6m/s ² (2G), 3minutes period, 30minutes each along X, Y and Z axis					
	IMPACT	196.1m/s ² (20G), 11ms, once each X, Y and Z axis					
SAFETY AND NOISE REGULATIONS	AGENCY APPROVALS	UL60950-1, CSA1402C, EN60950-1, EN50178 Complies with IEC60950-1 and DEN-AN					
	CONDUCTED NOISE	Complies with FCC-B					

*1 Please contact us about safety approvals for the model with option.
* Series/Parallel operation with other model is not possible.

External view

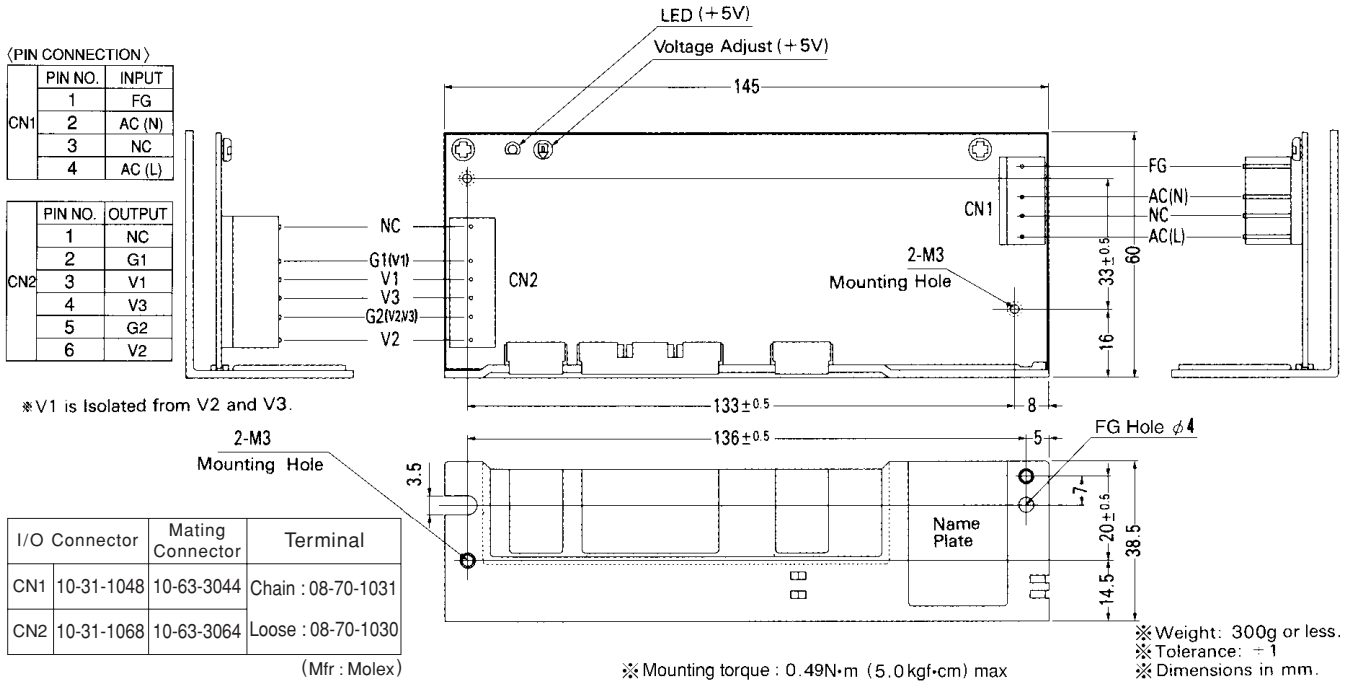

PMC

Performance data

■ STATIC CHARACTERISTICS (PMC30E-1)

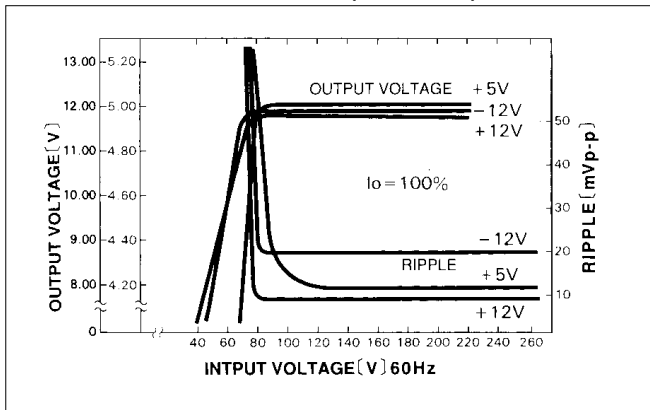

■ RISE TIME & FALL TIME (PMC30E-1)

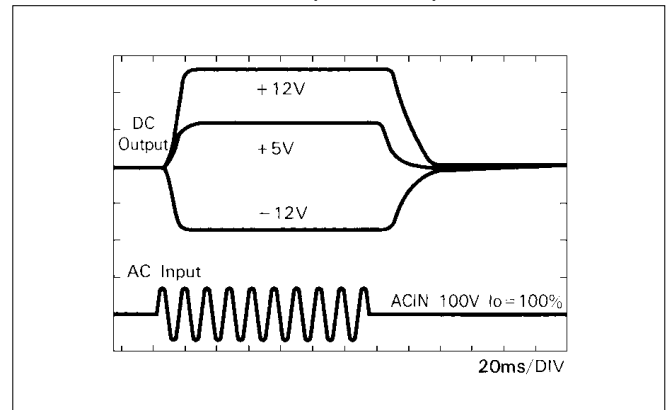

■ OVERCURRENT CHARACTERISTICS (PMC30E-1)

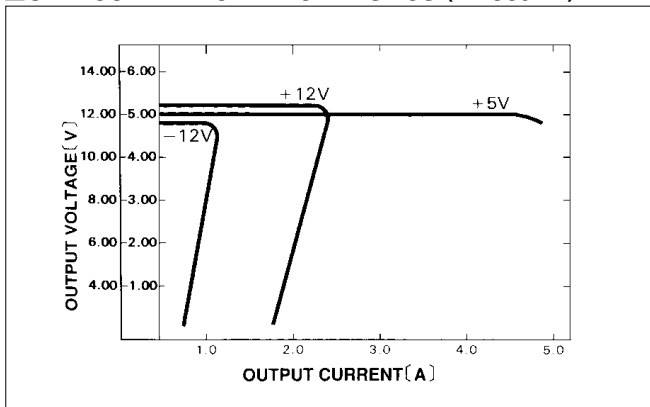

■ DERATING CURVE

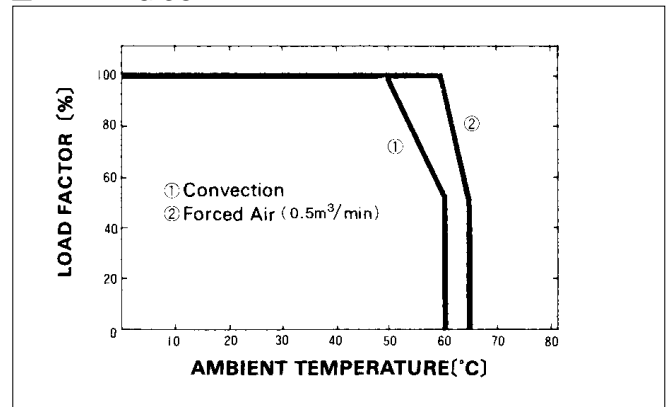

PMC50

PMC 50 E -1 -XULA -□

① ② ③ ④ ⑤

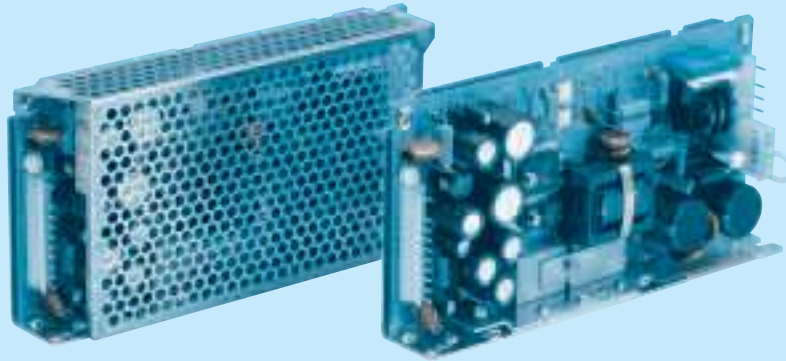

- ① Series name
- ② Output wattage
- ③ UL recognized, TÜV approved, CSA certified : E
- ④ Output voltage combination
- ⑤ Optional *1
C :with Coating
N :with Cover

PMC

MODEL		PMC50E-1-XULA	PMC50E-2-XULA	PMC50E-4-XULA
DC OUTPUT	V1	+5V 5.0A	+5V 5.0A	+5V 7.0A
	V2	+12V 1.25(Peak 2.0)A	+15V 1.0A	+12V 0.7(Peak 1.5)A
	V3	-12V 0.35A	-15V 0.35A	-12V 0.2A

SPECIFICATIONS

	MODEL	PMC50E-1-XULA			PMC50E-2-XULA			PMC50E-4-XULA			
INPUT	VOLTAGE[V]	AC85 - 132 / 170 - 264 1φ (User-selectable) or DC220 - 370									
	CURRENT[A]	ACIN 100V	1.4typ (Io=100%) User-selectable								
		ACIN 200V	0.7typ (Io=100%) User-selectable								
	FREQUENCY[Hz]	47 - 440									
	EFFICIENCY[%]	ACIN 100V	70typ (Io=100%)								
	INRUSH CURRENT[A]	ACIN 100V	20typ (Io=100%) (At cold start)								
ACIN 200V		40typ (Io=100%) (At cold start)									
OUTPUT	VOLTAGE[V]	+5	+12	-12	+5	+15	-15	+5	+12	-12	
	CURRENT[A]	0.75 - 5	0-1.25(Peak2.0)	0 - 0.35	0.75 - 5	0 - 1.0	0 - 0.35	0.75 - 7	0-0.7(Peak1.5)	0 - 0.2	
	MINIMUM CURRENT[A]	0.75	0	0	0.75	0	0	0.75	0	0	
	LINE REGULATION[mV]	20max	48max	48max	20max	60max	60max	20max	48max	48max	
	LOAD REGULATION[mV]	40max	150max	150max	40max	150max	150max	40max	150max	150max	
	RIPPLE[mVp-p]	80max	120max	120max	80max	120max	120max	80max	120max	120max	
	RIPPLE NOISE[mVp-p]	120max	150max	150max	120max	150max	150max	120max	150max	150max	
	TEMPERATURE REGULATION[mV]	0 to +50°C	50max	350max	350max	50max	350max	350max	50max	350max	350max
	START-UP TIME[ms]	100max (ACIN 85V, Io=100%)									
	HOLD-UP TIME[ms]	10typ (ACIN 85V, Io=100%) 20typ (ACIN 100V, Io=100%)									
	OUTPUT VOLTAGE ADJUSTMENT RANGE[V]	5.00 - 5.25	Fixed	Fixed	5.00 - 5.25	Fixed	Fixed	5.00 - 5.25	Fixed	Fixed	
OUTPUT VOLTAGE SETTING[V]	—	11.4 to 12.6	-11.4 to -12.6	—	14.25 to 15.75	-14.25 to -15.75	—	11.4 to 12.6	-11.4 to -12.6		
PROTECTION CIRCUIT	OVERCURRENT PROTECTION	Works at over 105% of rating (V2 works at peak current)and recovers automatically									
	OVERVOLTAGE PROTECTION	Works at 115 - 140% of rating (+5V)									
ISOLATION	INPUT-OUTPUT	AC3,000V 1minute, Cutoff current = 10mA, DC500V 50MΩmin (At Room Temperature)									
	INPUT-FG	AC2,000V 1minute, Cutoff current = 10mA, DC500V 50MΩmin (At Room Temperature)									
	OUTPUT-FG	AC500V 1minute, Cutoff current = 100mA, DC500V 50MΩmin (At Room Temperature)									
	OUTPUT-OUTPUT(V1-V2,V3)	AC100V 1minute, Cutoff current = 100mA, DC100V 10MΩmin (At Room Temperature)									
ENVIRONMENT	OPERATING TEMP.,HUMID.AND ALTITUDE	-10 to +65°C, 20 - 95%RH (Non condensing) (Refer to DERATING CURVE), 3,000m (10,000feet) max									
	STORAGE TEMP.,HUMID.AND ALTITUDE	-25 to +75°C, 20 - 95%RH (Non condensing), 9,000m (30,000feet) max									
	VIBRATION	10 - 55Hz, 19.6m/s ² (2G), 3minutes period, 30minutes each along X, Y and Z axis									
	IMPACT	196.1m/s ² (20G), 11ms, once each X, Y and Z axis									
SAFETY AND NOISE REGULATIONS	AGENCY APPROVALS	UL60950-1, CSA C22.2 No.60950-1, EN60950-1, EN50178 Complies with IEC60950-1 and DEN-AN									
	CONDUCTED NOISE	Complies with FCC-B									

*1 Please contact us about safety approvals for the model with option.
* Series/Parallel operation with other model is not possible.
* When units are operated with chassis and cover, derating is required.

External view

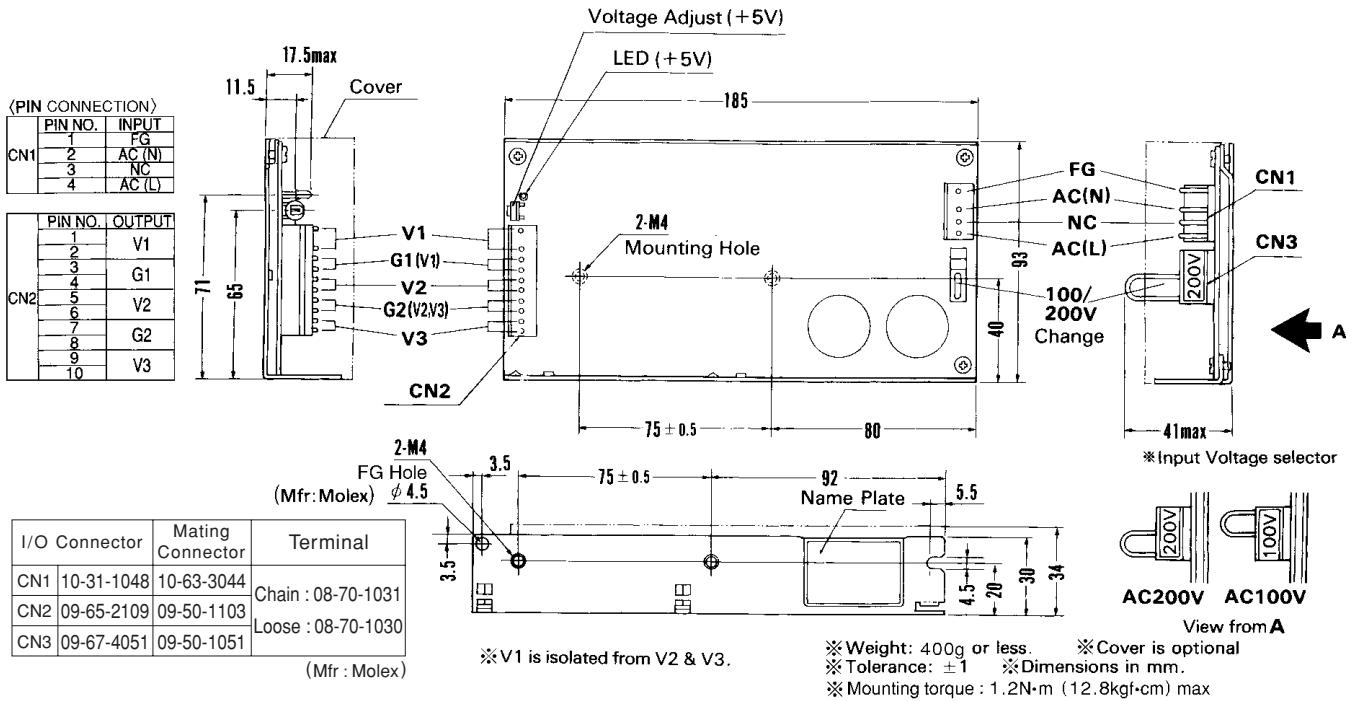

Performance data

■ STATIC CHARACTERISTICS (PMC50E-1-XULA)

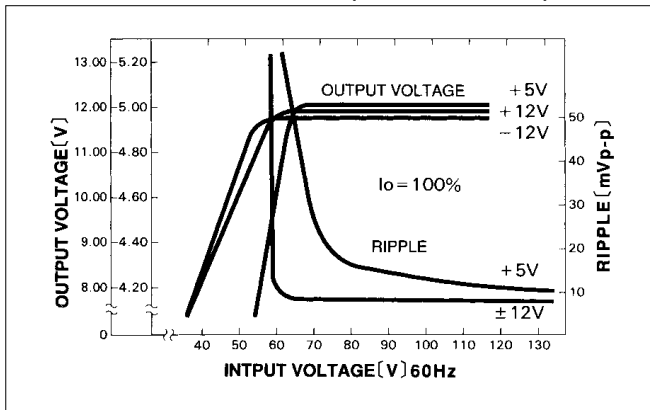

■ RISE TIME & FALL TIME (PMC50E-1-XULA)

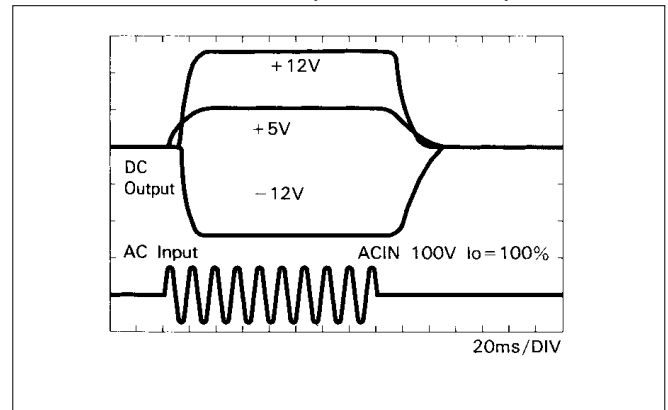

■ OVERCURRENT CHARACTERISTICS (PMC50E-1-XULA)

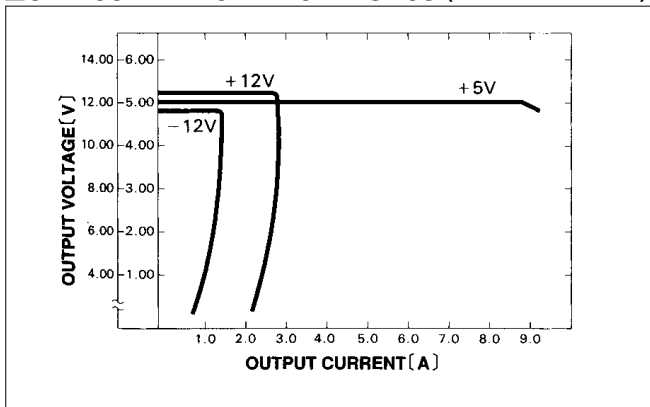

■ DERATING CURVE

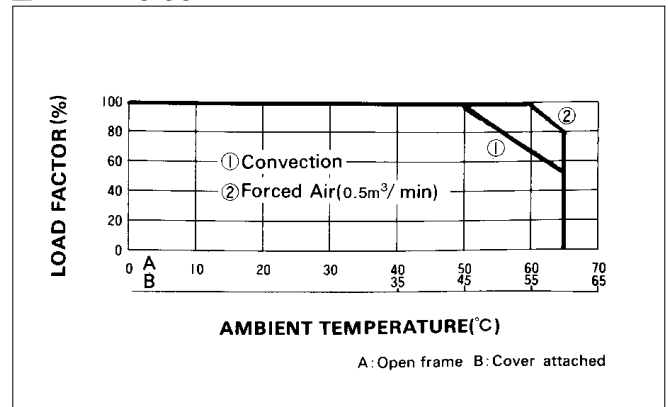

PMC75

PMC 75 E -1 -□

① ② ③ ④ ⑤



- ① Series name
- ② Output wattage
- ③ UL recognized, TÜV approved, CSA certified : E
- ④ Output voltage combination
- ⑤ Optional *1
C :with Coating
G :Low leakage current
J :Connector type
N :with Cover

PMC

MODEL		PMC75E-1	PMC75E-2	PMC75E-4
DC OUTPUT	V1	+5V 8.0A	+5V 8.0A	+5V 6.0A
	V2	+12V 2.5A	+15V 1.8A	+12V 3.2A
	V3	-12V 0.5A	-15V 0.5A	-12V 0.5A

SPECIFICATIONS

	MODEL	PMC75E-1			PMC75E-2			PMC75E-4			
INPUT	VOLTAGE[V]	AC85 - 132 / 170 - 264 1φ (User-selectable) or DC220 - 370									
	CURRENT[A]	ACIN 100V	1.8typ (Io=100%) User-selectable								
		ACIN 200V	1.0typ (Io=100%) User-selectable								
	FREQUENCY[Hz]	47 - 440									
	EFFICIENCY[%]	ACIN 100V	75typ (Io=100%)								
	INRUSH CURRENT[A]	ACIN 100V	15typ (Io=100%)								
ACIN 200V		30typ (Io=100%)									
OUTPUT	VOLTAGE[V]	+5	+12	-12	+5	+15	-15	+5	+12	-12	
	CURRENT[A]	8	2.5	0.5	8	1.8	0.5	6	3.2	0.5	
	MINIMUM CURRENT[A]	1.5	0	0	1.5	0	0	1.5	0	0	
	LINE REGULATION[mV]	20max	48max	48max	20max	60max	60max	20max	48max	48max	
	LOAD REGULATION[mV]	40max	100max	150max	40max	120max	150max	40max	100max	150max	
	RIPPLE[mVp-p]	80max	120max	120max	80max	120max	120max	80max	120max	120max	
	RIPPLE NOISE[mVp-p]	120max	150max	150max	120max	150max	150max	120max	150max	150max	
	TEMPERATURE REGULATION[mV]	0 to +50°C	50max	120max	350max	50max	150max	350max	50max	120max	350max
	START-UP TIME[ms]	200max (ACIN 85V, Io=100%)									
	HOLD-UP TIME[ms]	10typ (ACIN 85V, Io=100%) 20typ (ACIN 100V, Io=100%)									
PROTECTION CIRCUIT	OVERCURRENT PROTECTION	Works over 105% of rating and recovers automatically									
	OVERVOLTAGE PROTECTION	Works at 115 - 140% of rating (+5V)									
	ISOLATION	INPUT-OUTPUT	AC3,000V 1minute, Cutoff current = 10mA, DC500V 50MΩmin (At Room Temperature)								
ISOLATION	INPUT-FG	AC2,000V 1minute, Cutoff current = 10mA, DC500V 50MΩmin (At Room Temperature)									
	OUTPUT-FG	AC500V 1minute, Cutoff current = 100mA, DC500V 50MΩmin (At Room Temperature)									
	OUTPUT-OUTPUT(V1-V2,V3)	AC100V 1minute, Cutoff current = 100mA, DC100V 10MΩmin (At Room Temperature)									
ENVIRONMENT	OPERATING TEMP.,HUMID.AND ALTITUDE	-10 to +65°C, 20 - 95%RH (Non condensing) (Refer to DERATING CURVE), 3,000m (10,000feet) max									
	STORAGE TEMP.,HUMID.AND ALTITUDE	-25 to +75°C, 20 - 95%RH (Non condensing), 9,000m (30,000feet) max									
	VIBRATION	10 - 55Hz, 19.6m/s ² (2G), 3minutes period, 30minutes each along X, Y and Z axis									
	IMPACT	196.1m/s ² (20G), 11ms, once each X, Y and Z axis									
SAFETY AND NOISE REGULATIONS	AGENCY APPROVALS	UL60950-1, CSA C22.2 No.60950-1, EN60950-1, EN50178 Complies with IEC60950-1 and DEN-AN									
	CONDUCTED NOISE	Complies with FCC-B									

*1 Please contact us about safety approvals for the model with option.
* Series/Parallel operation with other model is not possible.
* When units are operated with chassis and cover, derating is required.

External view

(PIN CONNECTION)

PIN NO.	INPUT
1	FG
2	AC(L)
3	NC
4	AC(N)

PIN NO.	OUTPUT
1	V1
2	G1
3	V2
4	G2
5	V3
6	
7	
8	
9	
10	

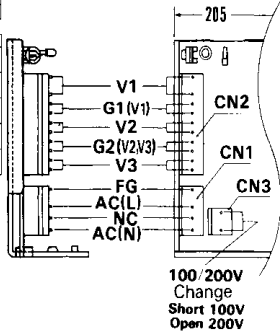

I/O Connector	Mating Connector	Terminal
CN1	10-31-1048	10-63-3044
CN2	09-65-2109	09-50-1103
CN3	10-31-1028	10-63-3024

Chain : 08-70-1031
Loose : 08-70-1030

(Mfr : Molex)

Connector type

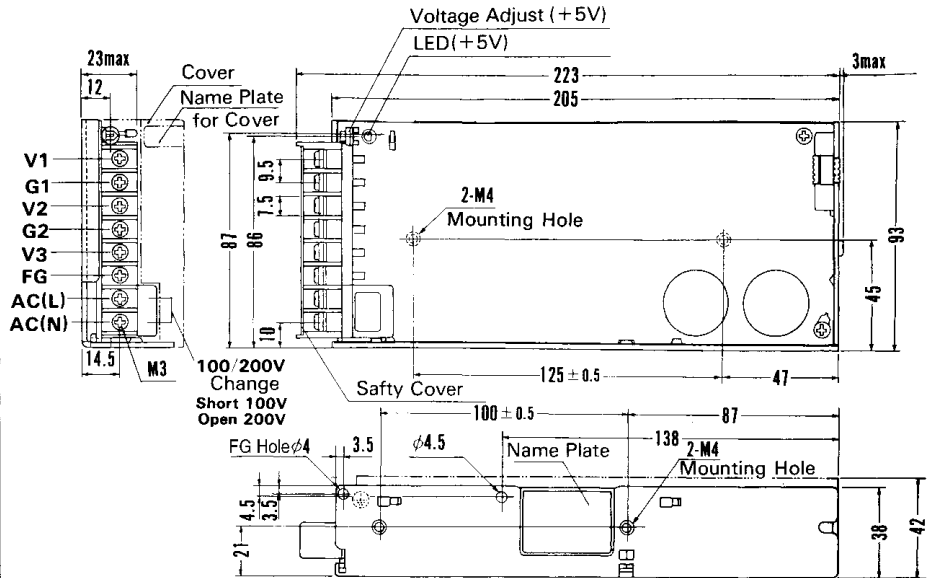

※V1 is isolated from V2 & V3.

- ※ Weight: 600g or less.
- ※ Tolerance: ± 1
- ※ Mounting torque : 1.2N·m (12.8kgf·cm) max
- ※ Cover is optional
- ※ Dimensions in mm

Barrier strip type

Performance data

■ STATIC CHARACTERISTICS (PMC75E-1)

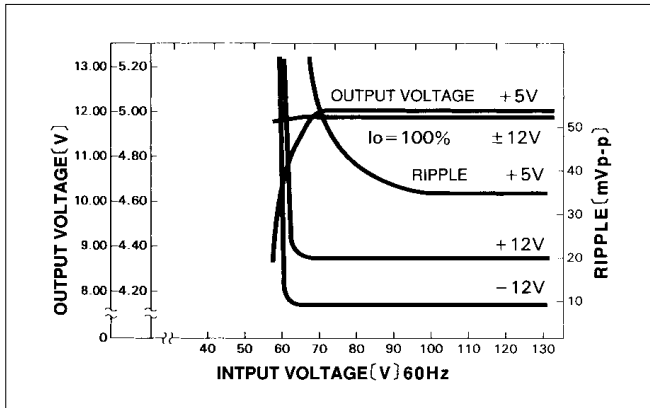

■ RISE TIME & FALL TIME (PMC75E-1)

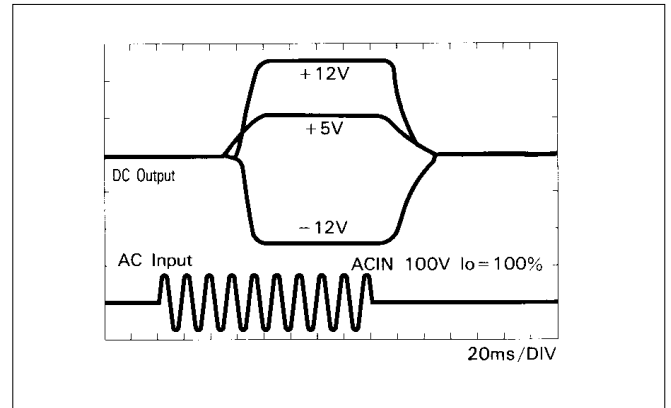

■ OVERCURRENT CHARACTERISTICS (PMC75E-1)

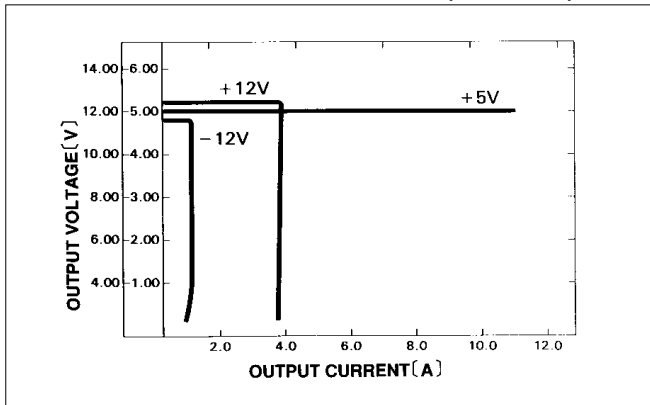

■ DERATING CURVE

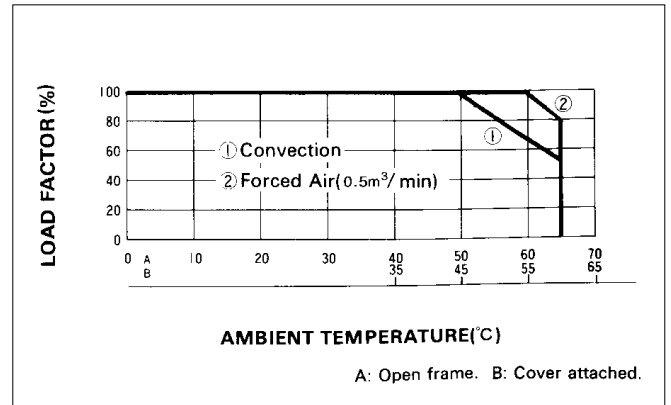

PMC100

PMC 100 E -1 -□

① ② ③ ④ ⑤

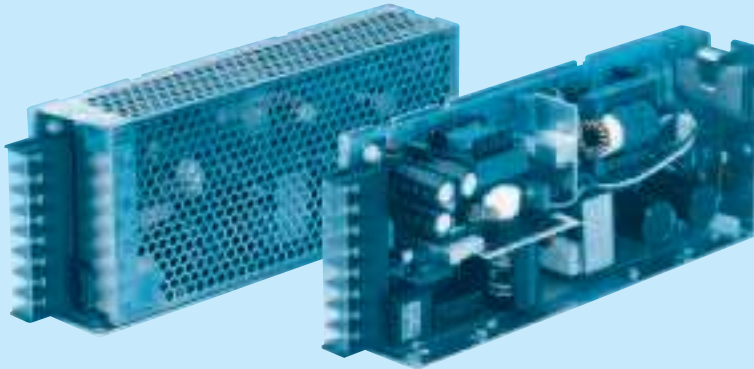

- ① Series name
- ② Output wattage
- ③ UL recognized, TÜV approved, CSA certified : E
- ④ Output voltage combination
- ⑤ Optional *1
G : Low leakage current
J : Connector type
N : with Cover

PMC

MODEL		PMC100E-1	PMC100E-2	PMC100E-4
DC OUTPUT	V1	+5V 13.0A	+5V 13.0A	+5V 8.0A
	V2	+12V 2.0A	+15V 1.5A	+12V 4.0A
	V3	-12V 1.0A	-15V 1.0A	-12V 1.0A

SPECIFICATIONS

	MODEL	PMC100E-1			PMC100E-2			PMC100E-4			
INPUT	VOLTAGE[V]	AC85 - 132 / 170 - 264 1φ (User-selectable) or DC220 - 370									
	CURRENT[A]	ACIN 100V	2.4typ (Io=100%) User-selectable								
		ACIN 200V	1.4typ (Io=100%) User-selectable								
	FREQUENCY[Hz]	47 - 440									
	EFFICIENCY[%]	ACIN 100V	75typ (Io=100%)								
	INRUSH CURRENT[A]	ACIN 100V	15typ (Io=100%)								
ACIN 200V		30typ (Io=100%)									
OUTPUT	VOLTAGE[V]	+5	+12	-12	+5	+15	-15	+5	+12	-12	
	CURRENT[A]	13	2	1	13	1.5	1	8	4	1	
	MINIMUM CURRENT[A]	1.5	0	0	1.5	0	0	1.5	0	0	
	LINE REGULATION[mV]	20max	48max	48max	20max	60max	60max	20max	48max	48max	
	LOAD REGULATION[mV]	40max	100max	150max	40max	120max	150max	40max	100max	150max	
	RIPPLE[mVp-p]	80max	120max	120max	80max	120max	120max	80max	120max	120max	
	RIPPLE NOISE[mVp-p]	120max	150max	150max	120max	150max	150max	120max	150max	150max	
	TEMPERATURE REGULATION[mV]	0 to +50°C	50max	120max	350max	50max	150max	350max	50max	120max	350max
	START-UP TIME[ms]	200max (ACIN 85V, Io=100%)									
	HOLD-UP TIME[ms]	10typ (ACIN 85V, Io=100%) 20typ (ACIN 100V, Io=100%)									
	OUTPUT VOLTAGE ADJUSTMENT RANGE[V]	5.00 - 5.25	Fixed	Fixed	5.00 - 5.25	Fixed	Fixed	5.00 - 5.25	Fixed	Fixed	
OUTPUT VOLTAGE SETTING[V]	—	11.4 to 12.6	-11.4 to -12.6	—	14.25 to 15.75	-14.25 to -15.75	—	11.4 to 12.6	-11.4 to -12.6		
PROTECTION CIRCUIT	OVERCURRENT PROTECTION	Works over 105% of rating and recovers automatically									
	OVERVOLTAGE PROTECTION	Works at 115 - 140% of rating (+5V)									
ISOLATION	INPUT-OUTPUT	AC3,000V 1minute, Cutoff current = 10mA, DC500V 50MΩmin (At Room Temperature)									
	INPUT-FG	AC2,000V 1minute, Cutoff current = 10mA, DC500V 50MΩmin (At Room Temperature)									
	OUTPUT-FG	AC500V 1minute, Cutoff current = 100mA, DC500V 50MΩmin (At Room Temperature)									
	OUTPUT-OUTPUT(V1-V2,V3)	AC100V 1minute, Cutoff current = 100mA, DC100V 10MΩmin (At Room Temperature)									
ENVIRONMENT	OPERATING TEMP., HUMID. AND ALTITUDE	-10 to +65°C, 20 - 95%RH (Non condensing) (Refer to DERATING CURVE), 3,000m (10,000feet)									
	STORAGE TEMP., HUMID. AND ALTITUDE	-25 to +75°C, 20 - 95%RH (Non condensing) 9,000m (30,000feet) max									
	VIBRATION	10 - 55Hz, 19.6m/s ² (2G), 3minutes period, 30minutes each along X, Y and Z axis									
	IMPACT	196.1m/s ² (20G), 11ms, once each X, Y and Z axis									
SAFETY AND NOISE REGULATIONS	AGENCY APPROVALS	UL60950-1, CSA1402C, EN60950-1, EN50178 Complies with IEC60950-1 and DEN-AN									
	CONDUCTED NOISE	Complies with FCC-B									

*1 Please contact us about safety approvals for the model with option.
* Series/Parallel operation with other model is not possible.
* When units are operated with chassis and cover, derating is required.

External view

(PIN CONNECTION)

PIN NO.	INPUT
1	FG
2	AC(L)
3	NC
4	AC(N)

PIN NO.	OUTPUT
1	V1
2	G1
3	V2
4	G2
5	V3
6	
7	
8	
9	
10	

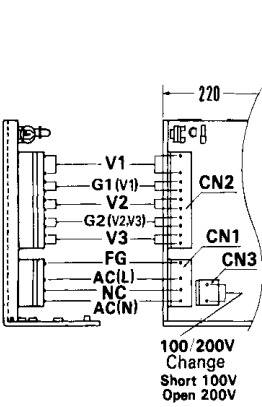

100/200V Change
Short 100V
Open 200V

I/O Connector	Mating Connector	Terminal
CN1	10-31-1048	10-63-3044
CN2	09-65-2109	09-50-1103
CN3	10-31-1028	10-63-3024

(Mfr: Molex)

Connector type

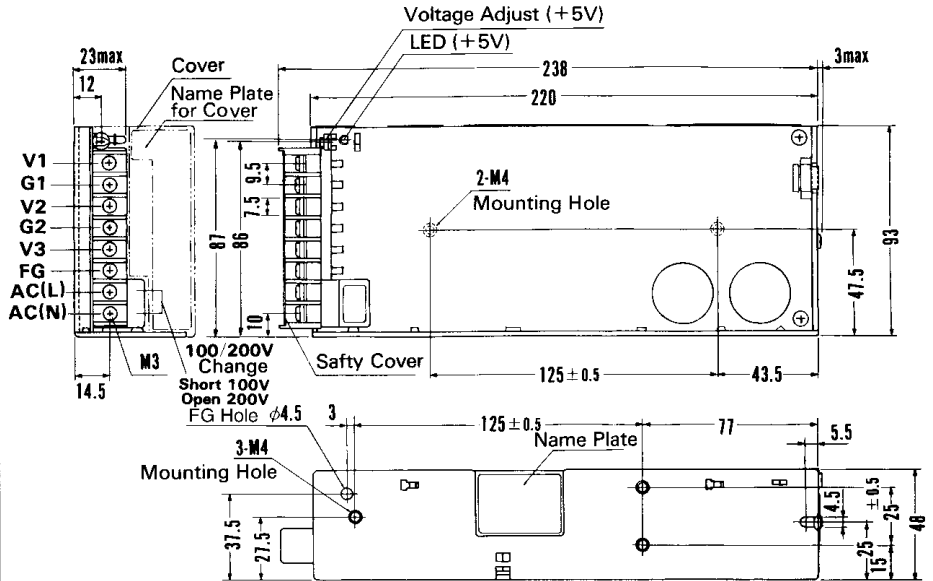

※ V1 is isolated from V2 & V3.

※ Weight: 750g or less. ※ Cover is optional
 ※ Tolerance: ±1 ※ Dimensions in mm.
 ※ Mounting torque: 1.2N·m (12.8kgf·cm) max

Barrier strip type

Performance data

■ STATIC CHARACTERISTICS (PMC100E-1)

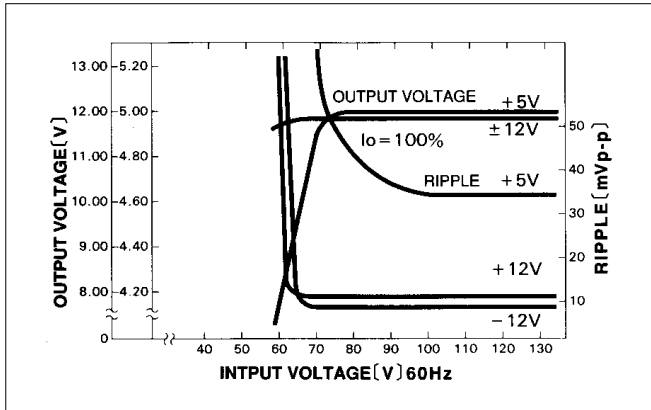

■ RISE TIME & FALL TIME (PMC100E-1)

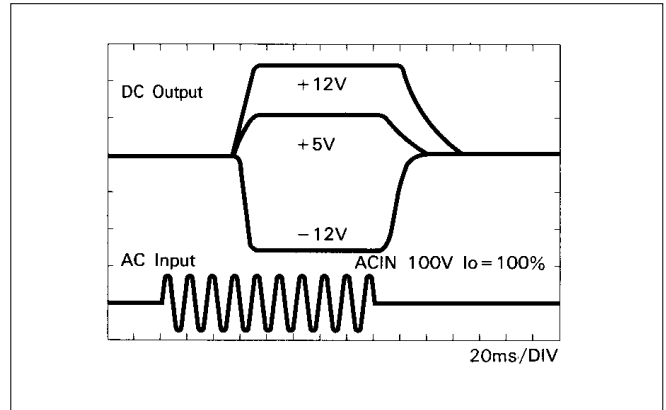

■ OVERCURRENT CHARACTERISTICS (PMC100E-1)

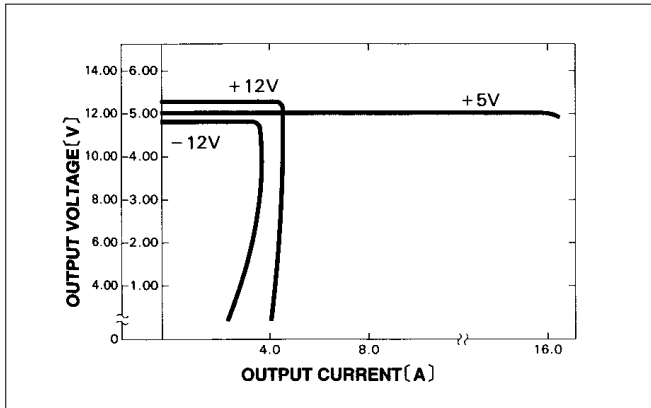

■ DERATING CURVE

