

MMBT2907A-G (PNP)

RoHS Device

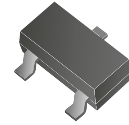

Features

- Epitaxial planar die construction
- Device is designed as a general purpose amplifier and switching.
- Useful dynamic range exceeds to 600mA As a switch and to 100MHz as an amplifier.

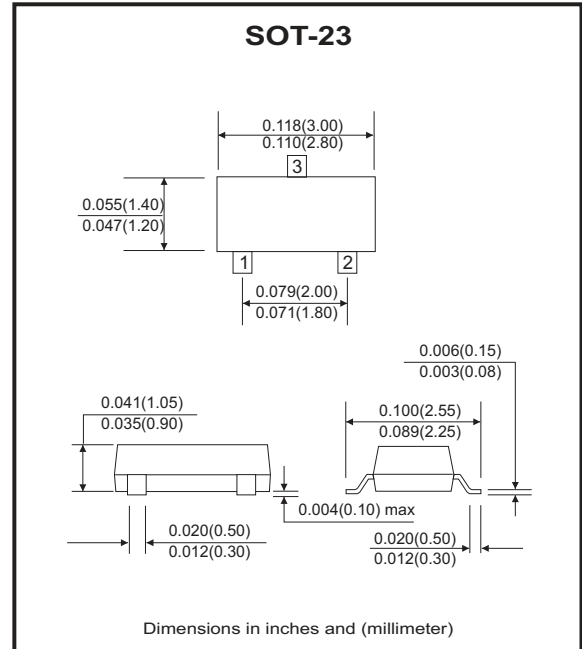
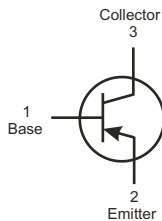

Maximum Ratings (at Ta=25°C unless otherwise noted)

Parameter	Symbol	Value	Units
Collector-Base voltage	V_{CB0}	-60	V
Collector-Emitter voltage	V_{CEO}	-60	V
Emitter-Base voltage	V_{EBO}	-5	V
Collector current-continuous	I_C	-600	mA
Total device dissipation	P_D	250	mW
Thermal resistance, junction to ambient	$R_{\theta JA}$	500	°C/W
Junction temperature	T_J	150	°C
Storage temperature range	T_{STG}	-55 to +150	°C

Company reserves the right to improve product design , functions and reliability without notice.

Electrical Characteristics (@TA=25°C unless otherwise noted)

Parameter	Symbol	Conditions	Min.	Max.	Units
Collector-Base breakdown voltage	$V_{(BR)CBO}$	$I_C = -10\mu A, I_E = 0$	-60		V
Collector-Emitter breakdown voltage (Note 1)	$V_{(BR)CEO}$	$I_C = -10mA, I_B = 0$	-60		V
Emitter-Base breakdown voltage	$V_{(BR)EBO}$	$I_E = -10\mu A, I_C = 0$	-5		V
Collector cut-off current	I_{CBO}	$V_{CB} = -50V, I_E = 0$		-20	nA
Base cut-off current	I_{EBO}	$V_{EB} = -3V, I_C = 0$		-10	nA
Collector cut-off current	I_{CEX}	$V_{CE} = -30V, V_{BE(off)} = -0.5V$		-50	nA
DC current gain	$h_{FE(1)}$	$V_{CE} = -10V, I_C = -150mA$	100	300	
	$h_{FE(2)}$	$V_{CE} = -10V, I_C = -0.1mA$	75		
	$h_{FE(3)}$	$V_{CE} = -10V, I_C = -1mA$	100		
	$h_{FE(4)}$	$V_{CE} = -10V, I_C = -10mA$	100		
	$h_{FE(5)}$	$V_{CE} = -10V, I_C = -500mA$	50		
Collector-Emitter saturation voltage (Note 1)	$V_{CE(sat)}$	$I_C = -150mA, I_B = -15mA$ $I_C = -500mA, I_B = -50mA$		-0.4 -1.6	V
Base-Emitter saturation voltage (Note 1)	$V_{BE(sat)}$	$I_C = -150mA, I_B = -15mA$ $I_C = -500mA, I_B = -50mA$		-1.3 -2.6	V
Transition frequency	f_T	$V_{CE} = -20V, I_C = -50mA$ $f = 100MHz$	200		MHz
Delay time	t_d	$V_{CE} = -30V$ $I_C = -150mA, I_{B1} = -15mA$		10	nS
Rise time	t_r			25	nS
Storage time	t_s	$V_{CE} = -6V, I_C = -150mA$ $I_{B1} = -I_{B2} = -15mA$		225	nS
Fall time	t_f			60	nS

Notes:

1. Pulse test: Pulse Width $\leq 300\mu s$, Duty Cycle $\leq 2.0\%$.

Company reserves the right to improve product design, functions and reliability without notice.

RATING AND CHARACTERISTIC CURVES (MMBT2907A-G)

Fig.1 - Static Characteristic

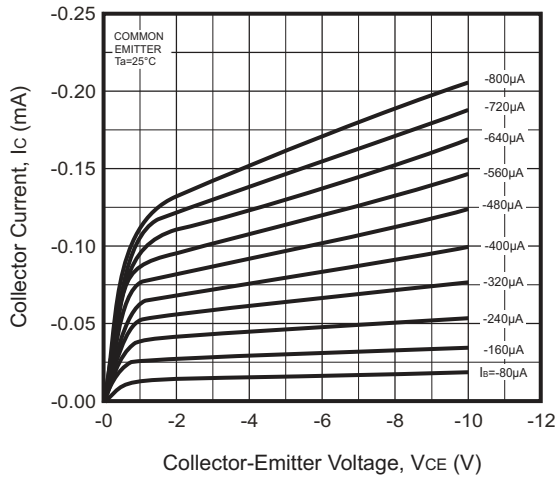

Fig.2 - hFE — Ic

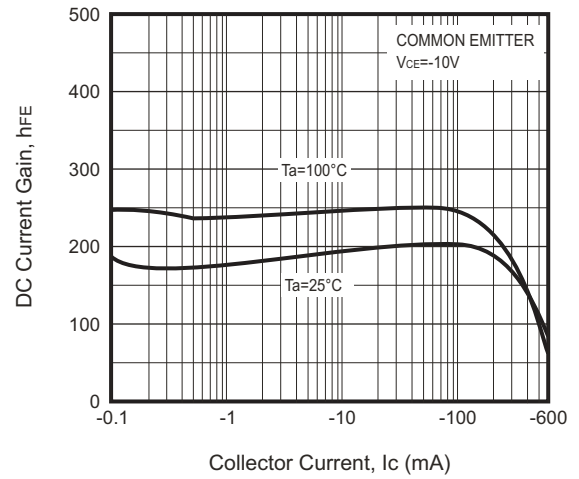

Fig.3 - VCEsat — Ic

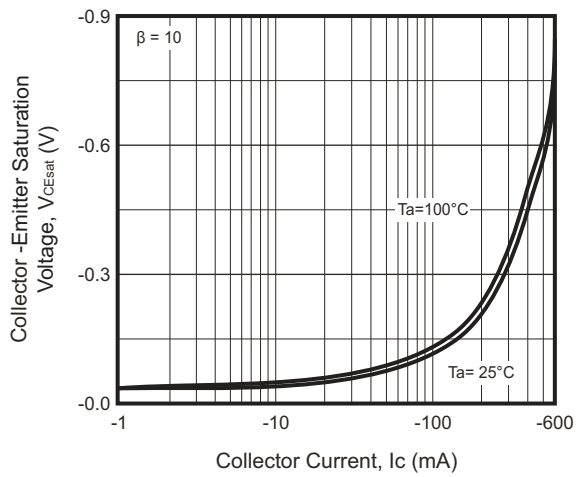
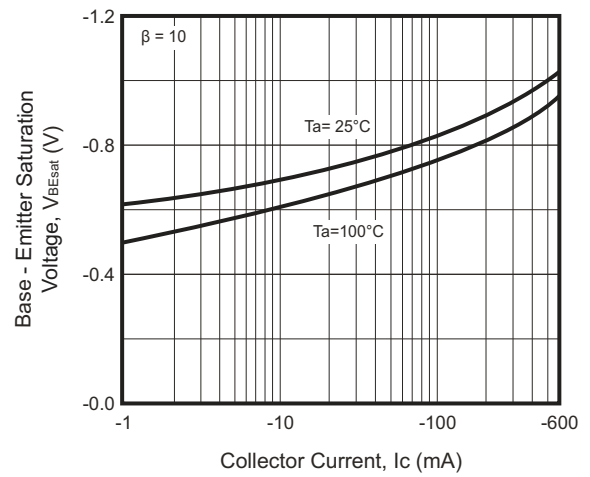

Fig.4 - VBEsat — Ic



Company reserves the right to improve product design , functions and reliability without notice.

RATING AND CHARACTERISTIC CURVES (MMBT2907A-G)

Fig.5 - I_c — V_{BE}

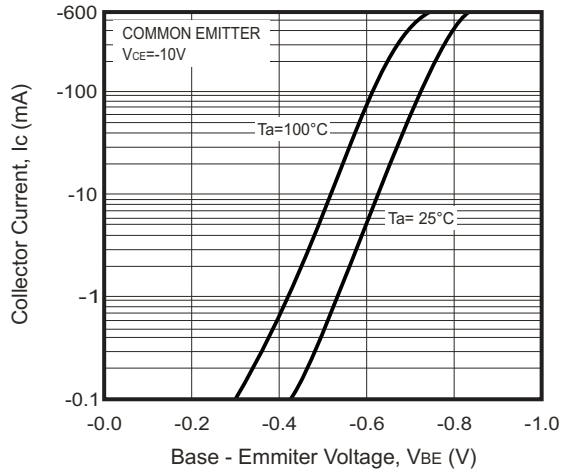

Fig.6 - C_{ob}/C_{ib} — V_{CB}/V_{EB}

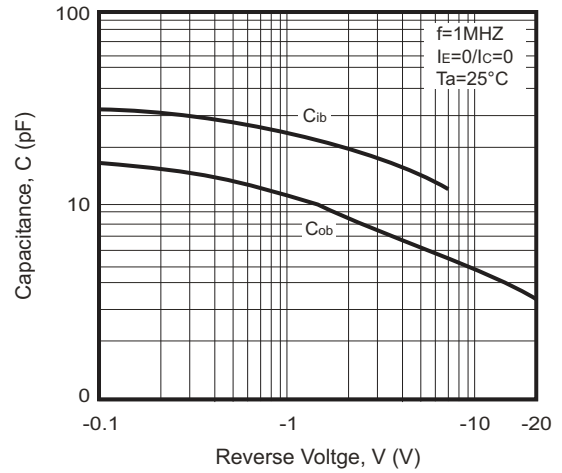
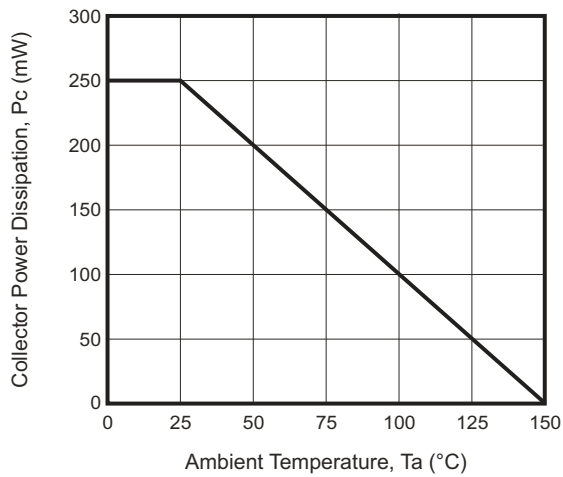
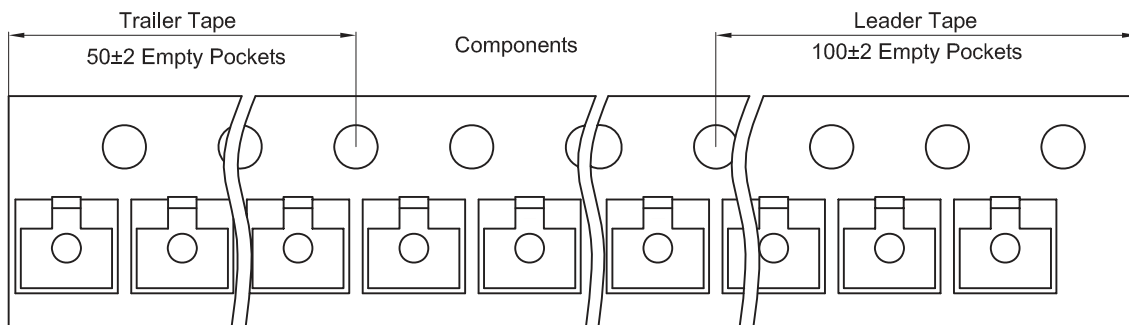
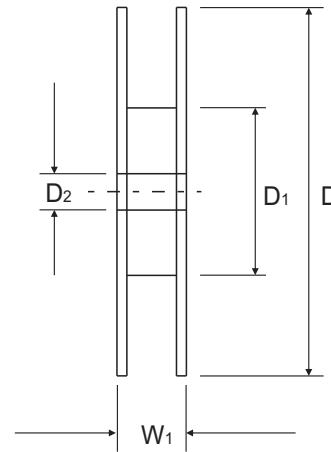
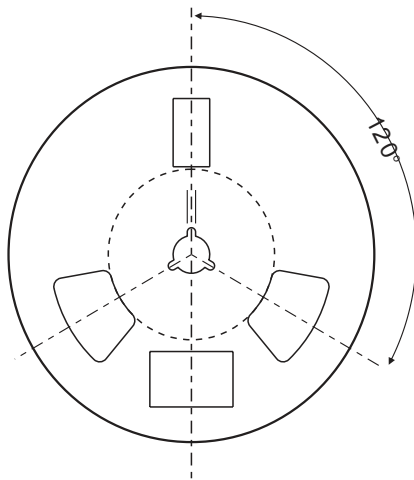
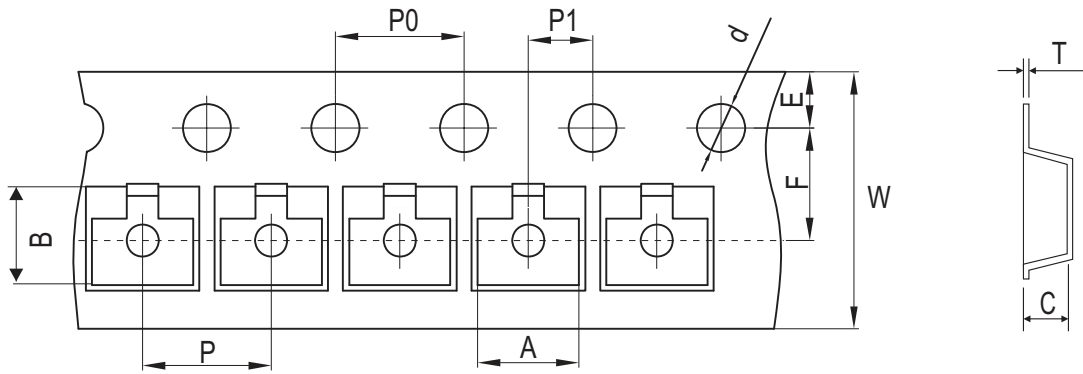

Fig.7 - P_c — T_a



Company reserves the right to improve product design , functions and reliability without notice.

Reel Taping Specification



SOT-23	SYMBOL	A	B	C	d	D	D1	D2
	(mm)	3.15 ± 0.10	2.77 ± 0.10	1.22 ± 0.10	Φ1.50 ± 0.10	178 ± 2.00	54.40 ± 1.00	13.00 ± 1.00
	(inch)	0.124 ± 0.004	0.109 ± 0.004	0.048 ± 0.004	Φ0.059 ± 0.004	7.008 ± 0.079	2.142 ± 0.039	0.512 ± 0.039

SOT-23	SYMBOL	E	F	P	P0	P1	W	W1
	(mm)	1.75 ± 0.10	3.50 ± 0.10	4.00 ± 0.10	4.00 ± 0.10	2.00 ± 0.10	8.00 + 0.30 / - 0.10	12.30 ± 1.00
	(inch)	0.069 ± 0.004	0.138 ± 0.004	0.157 ± 0.004	0.157 ± 0.004	0.079 ± 0.004	0.315 + 0.012 / - 0.004	0.484 ± 0.039

Company reserves the right to improve product design , functions and reliability without notice.

Marking Code

Part Number	Marking Code
MMBT2907A-G	2F

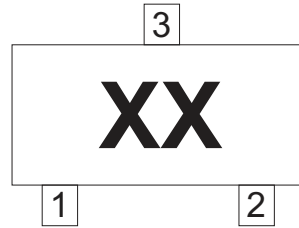

xx = Product type marking code

Suggested PAD Layout

SIZE	SOT-23	
	(mm)	(inch)
A	0.80	0.031
B	1.90	0.075
C	2.02	0.080
D	2.82	0.111

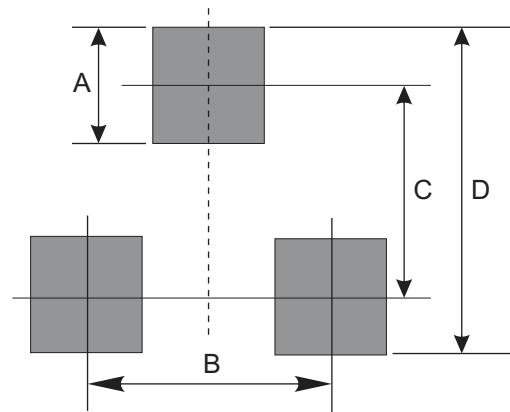

Standard Packaging

Case Type	REEL PACK	
	REEL (pcs)	Reel Size (inch)
SOT-23	3,000	7

Company reserves the right to improve product design , functions and reliability without notice.