

DESCRIPTION

The EV8869S-L-00A is used for demonstrating the performance of MPS's MP8869S. MP8869S is a highly integrated and high frequency synchronous step-down switcher with I²C control interface. It is optimized to support up to 12A continuous/15A peak output current over an input supply range from 2.85V to 18V with excellent load and line regulation.

COT control operation provides fast transient response and eases loop stabilization. In I²C control loop, the output voltage level can be controlled, on-the fly through an I²C serial interface. Output voltage range can be adjusted from 0.6V to 1.108V in 4mV steps. Voltage scaling slew rate, enable and power saving mode are also selectable through the I²C interface. Full protection features include over voltage, over-current protection and thermal shut down.

The MP8869S is available in QFN-14(3mmx4mm) package.

ELECTRICAL SPECIFICATION

Parameter	Symbol	Value	Units
Input Voltage	V _{IN}	2.85– 18	V
Output Voltage	V _{OUT}	1	V
Continuous Output Current	I _{OUT}	12	A
Peak Output Current	I _{OUT}	15	A

FEATURES

- Vout Adjustable up to 5.5V using FB pin
- Wide 2.85V-to-18V Operating Input Range
- 12A Continuous/15A Peak Output Current
- 1% Internal Reference Accuracy
- I²C Programmable Output Range from 0.6V to 1.108V in 4mV Steps with Slew Rate Control
- 5% Accuracy Output Voltage and Output Current Read Back Via I²C
- Selectable PFM/PWM Mode and Adjustable Frequency & Current Limit Through I²C
- 4 Different I²C Address Selectable
- External Soft Start
- Open Drain Power Good Indication
- Output Over Voltage Protection
- Hiccup/Latch off OCP Protection
- QFN-14(3mmx4mm) Package

APPLICATIONS

- Solid State Driver (SSD)
- Flat-Panel Television and Monitors
- Digital Set-Top Boxes
- Distributed Power Systems

All MPS parts are lead-free, halogen free, and adhere to the RoHS directive. For MPS green status, please visit MPS website under Quality Assurance. "MPS" and "The Future of Analog IC Technology" are Registered Trademarks of Monolithic Power Systems, Inc.

EV8869S-L-00A EVALUATION BOARD



(4 layer PCB, 8.5cmx8.5cm)

Board Number	MPS IC Number
EV8869S-L-00A	MP8869SGL

Efficiency vs. Output Current
V_{OUT}=1V, L=1.5μH, DCR=2.1mΩ

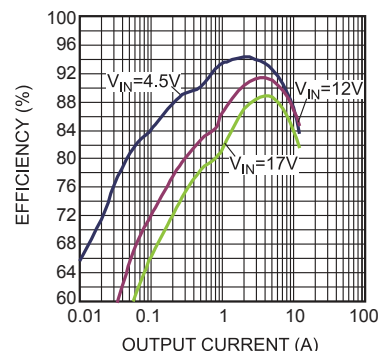

EVALUATION BOARD SCHEMATIC

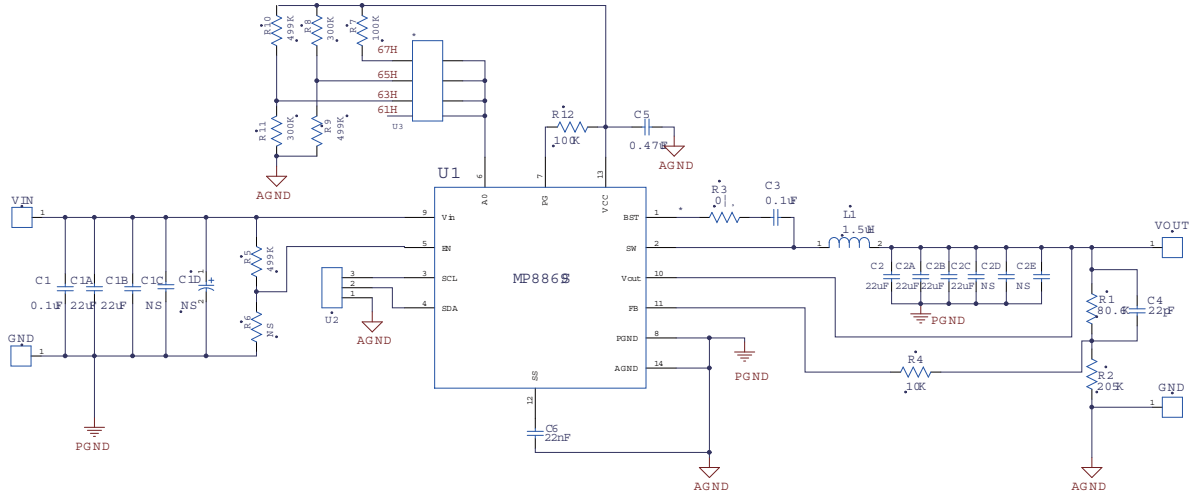

EV8869S-L-00A BILL OF MATERIALS

Qty	Ref	Value	Description	Package	Manufacturer	Manufacturer P/N
1	R1	80.6k	Film Res,1%	0603	ROYAL	RC0603FR-0780K6L
1	R2	205k	Film Res,1%	0603	ROYAL	RL0603FR-07205KL
1	R3	0 Ω	Film Res,1%	0603	ROYAL	RC0603FR-070RL
1	R4	10k	Film Res,1%	0603	ROYAL	RL0603FR-0710KL
3	R5, R9, R10	499k	Film Res,1%	0603	ROYAL	RL0603FR-07499KL
0	R6	NS				
2	R7,R12	100k	Film Res,1%	0603	ROYAL	RL0603FR-07100KL
2	R8,R11	300k	Film Res,1%	0603	ROYAL	RL0603FR-07300KL
2	C1, C3	0.1μF	Ceramic Cap, 25V,X7R	0603	muRata	GRM188R71E104KA01D
2	C1A,C1B,	22μF	Ceramic Cap,25V,X5R	1206	muRata	GRM31CR61E226KE15L
4	C2,C2A, C2B,C2C	22μF	Ceramic Cap , 25V,X5R	0805	muRata	GRM21BR61E226ME44L
0	C1C,C1D, C2D,C2E	NS				
1	C4	22pF	Ceramic Cap, 50V, X7R	0603	muRata	GRM1885C1H220JA01D
1	C5	0.47μF	Ceramic Cap,16V,X7R	0603	muRata	GRM188R71C474KA88D
1	C6	22nF	Ceramic Cap,16V,X7R	0603	muRata	GRM188R71C223KA01D
1	L1	1.5μH	Inductor, DCR=2.1mΩ	SMD	Wurth	7443320150
1	U1	MP8869 S	Step-Down Converter with I2C Interface	QFN14 (3*4)	MPS	MP8869SGL
1	U2	Jumper	3 pin jumper	DIP	any	
1	U3	Switch-4	Switch-4	SMD	Wurth	416 131 160 804

EVB TEST RESULTS

Performance waveforms are tested on the evaluation board.

$V_{IN} = 12V$, $V_{OUT} = 1V$, $L = 1.5\mu H$, $F_S = 500kHz$, Auto PFM/PWM mode, $T_A = 25^\circ C$, unless otherwise noted.

Enabled Supply Current vs. Input Voltage

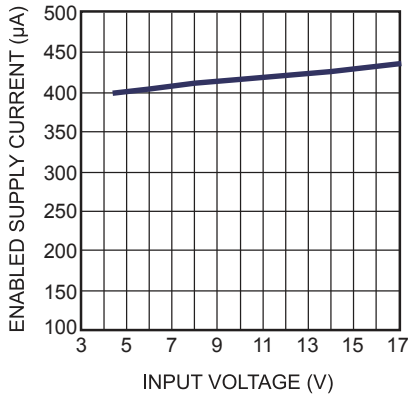

Disabled Supply Current vs. Input Voltage

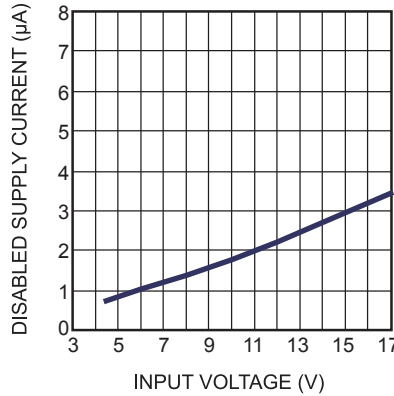

V_{IN} UVLO Rising Threshold vs. Temperature

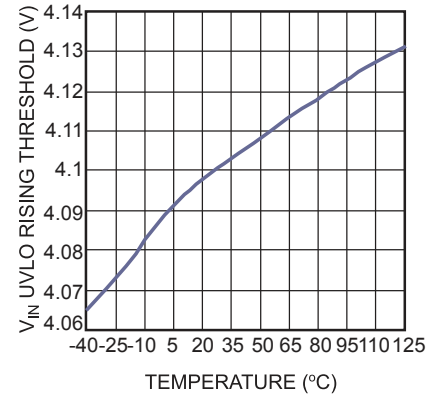

EN Rising Threshold vs. Temperature

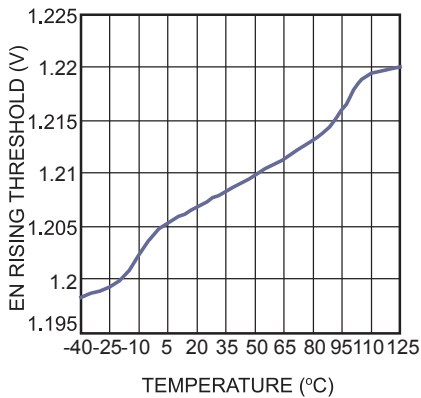

Reference Voltage vs. Temperature

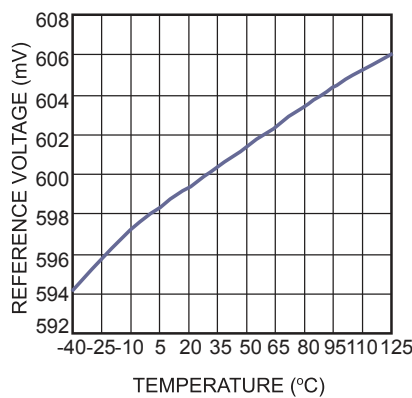

Line Regulation vs. Input Voltage

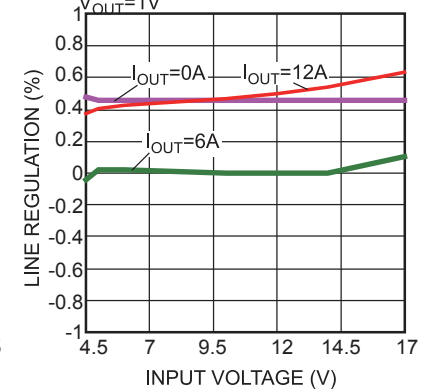

Efficiency vs. Output Current
 $V_{OUT}=1V$, $L=1.5\mu H$, $DCR=2.1m\Omega$

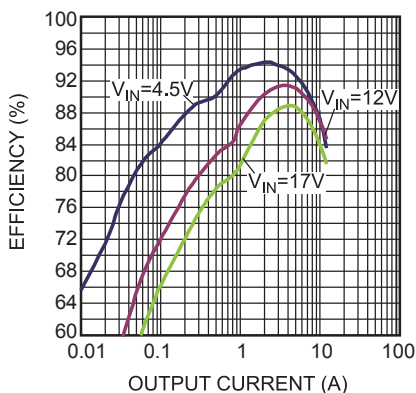

Efficiency vs. Output Current
 $V_{OUT}=1.2V$, $L=1.5\mu H$, $DCR=2.1m\Omega$

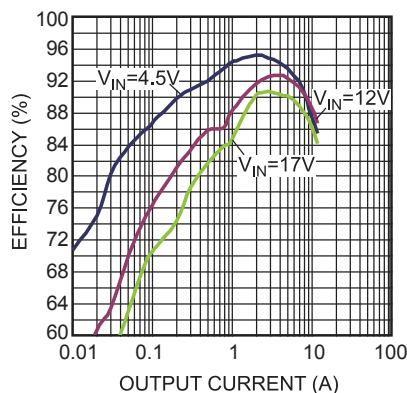

Efficiency vs. Output Current
 $V_{OUT}=1.5V$, $L=1.5\mu H$, $DCR=2.1m\Omega$

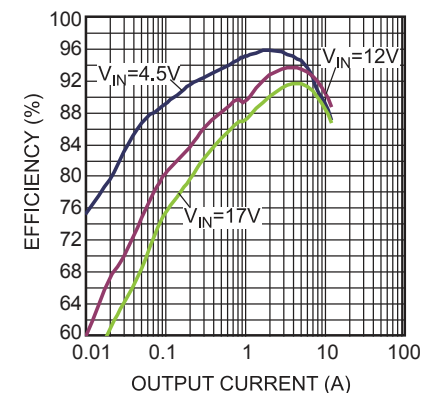

EVB TEST RESULTS (continued)

Performance waveforms are tested on the evaluation board.

$V_{IN} = 12V$, $V_{OUT} = 1V$, $L = 1.5\mu H$, $F_S = 500kHz$, Auto PFM/PWM mode, $T_A = 25^\circ C$, unless otherwise noted.

Efficiency vs. Output Current
 $V_{OUT}=1.8V$, $L=1.5\mu H$, $DCR=2.1m\Omega$

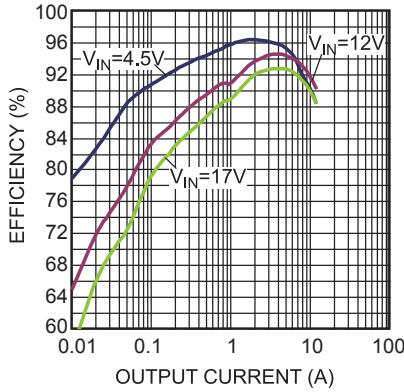

Efficiency vs. Output Current
 $V_{OUT}=2.5V$, $L=2.2\mu H$, $DCR=3m\Omega$

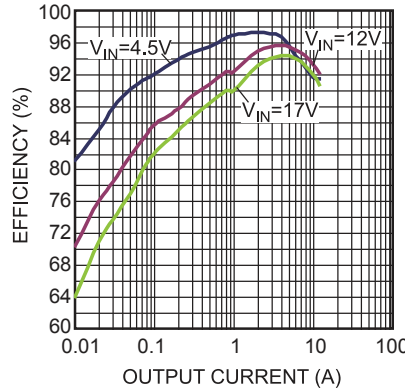

Efficiency vs. Output Current
 $V_{OUT}=3.3V$, $L=2.2\mu H$, $DCR=3m\Omega$

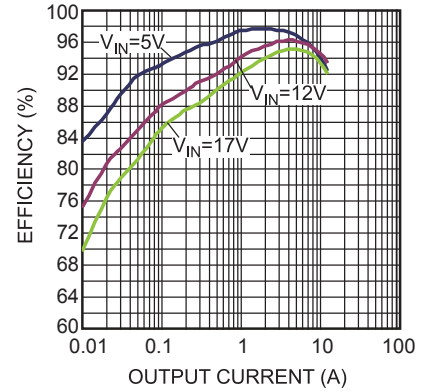

Efficiency vs. Output Current
 $V_{OUT}=5V$, $L=3.3\mu H$, $DCR=4.4m\Omega$

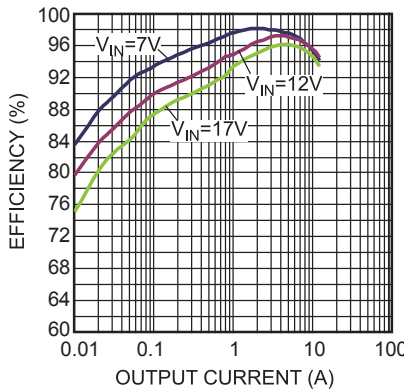

Load Regulation vs. Output Current
 $V_{OUT}=1V$

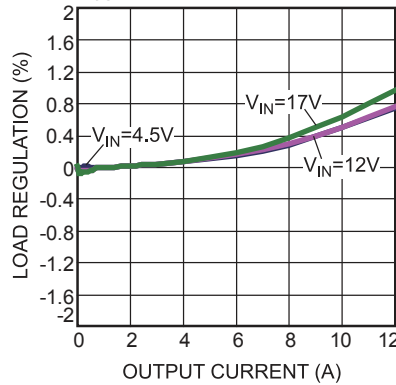

Load Regulation vs. Output Current
 $V_{OUT}=1.2V$

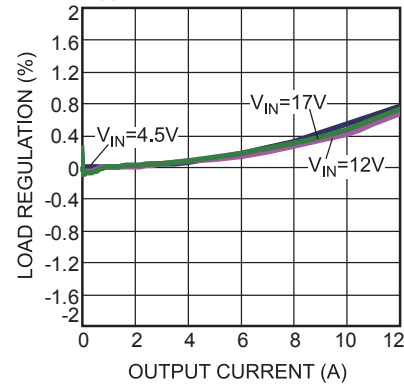

Load Regulation vs. Output Current
 $V_{OUT}=1.5V$

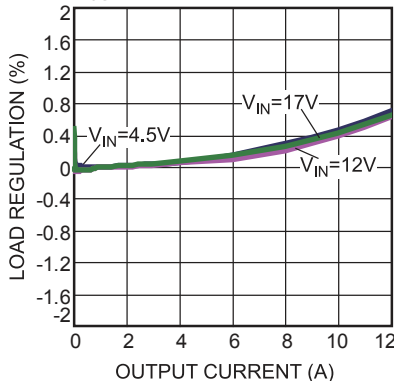

Load Regulation vs. Output Current
 $V_{OUT}=1.8V$

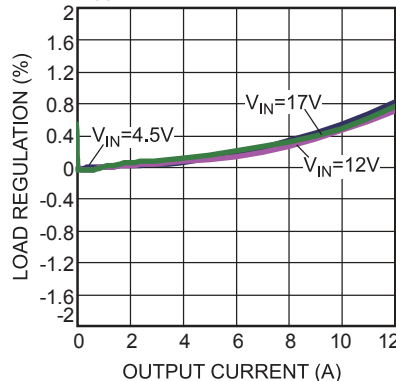

Load Regulation vs. Output Current
 $V_{OUT}=2.5V$

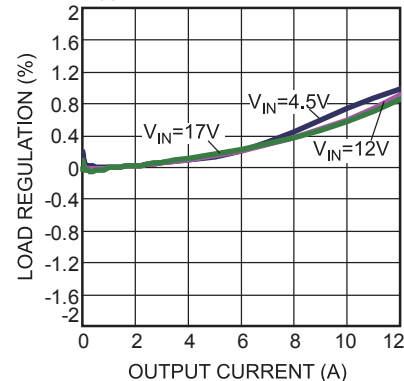

EVB TEST RESULTS *(continued)*

Performance waveforms are tested on the evaluation board.

$V_{IN} = 12V$, $V_{OUT} = 1V$, $L = 1.5\mu H$, $F_S = 500kHz$, Auto PFM/PWM mode, $T_A = 25^\circ C$, unless otherwise noted.

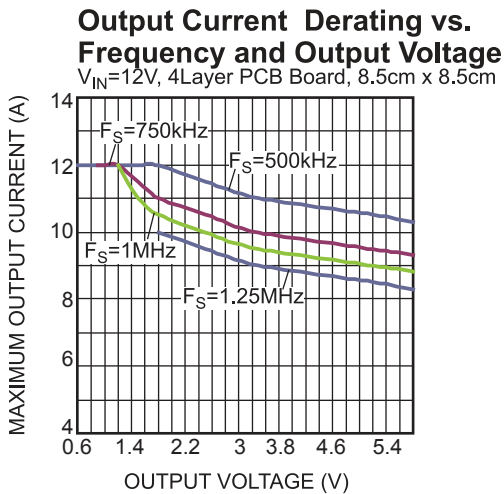
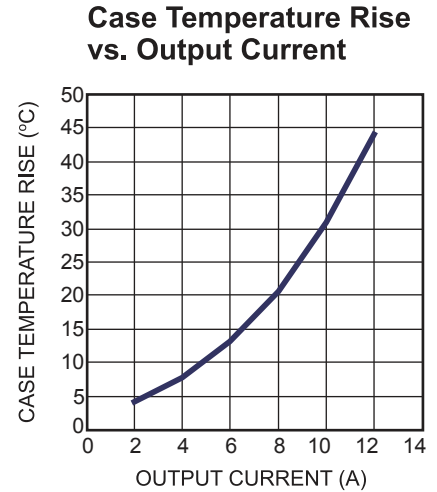
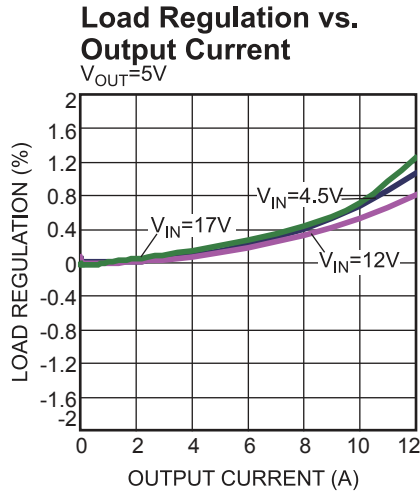
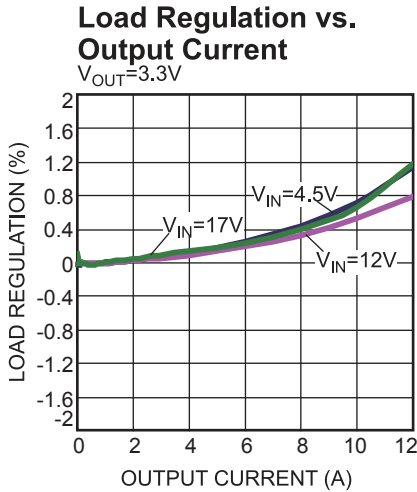

EVB TEST RESULTS (continued)

Performance waveforms are tested on the evaluation board.

$V_{IN} = 12V$, $V_{OUT} = 1V$, $L = 1.5\mu H$, $F_S = 500kHz$, Auto PFM/PWM mode, $T_A = 25^\circ C$, unless otherwise noted.

Input/Output Ripple

$I_{OUT} = 0A$

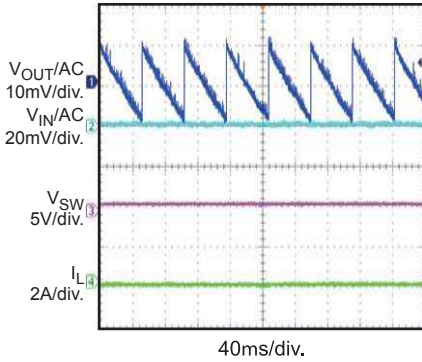

Input/Output Ripple

$I_{OUT} = 0A$

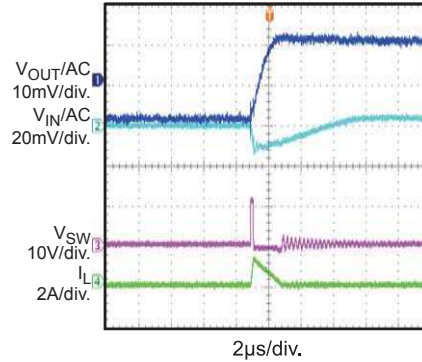

Input/Output Ripple

$I_{OUT} = 0A$, Forced PWM Mode

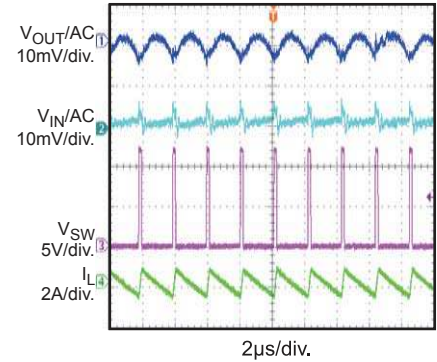

Input/Output Ripple

$I_{OUT} = 12A$

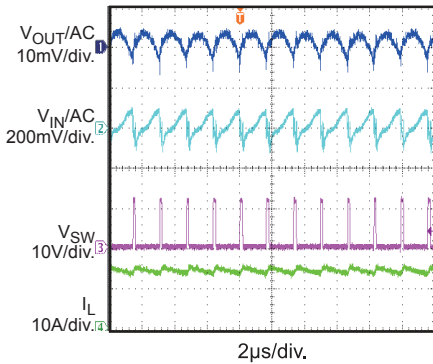

Start-Up through Input Voltage

$I_{OUT} = 0A$

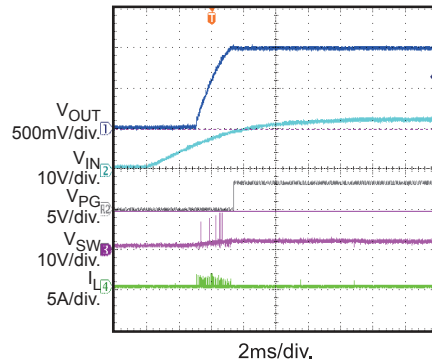

Start-Up through Input Voltage

$I_{OUT} = 12A$

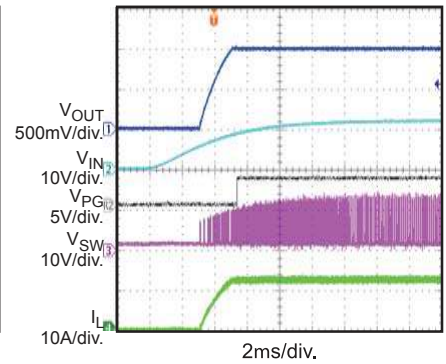

Shutdown through Input Voltage

$I_{OUT} = 0A$

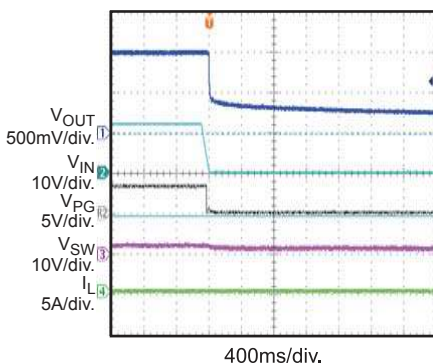

Shutdown through Input Voltage

$I_{OUT} = 12A$

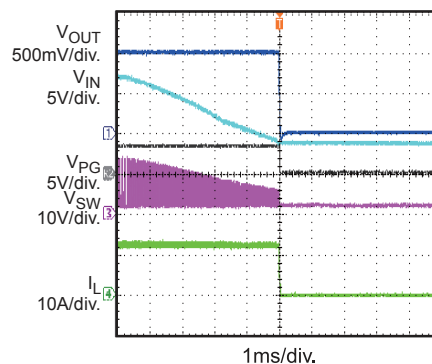

Start-Up through EN

$I_{OUT} = 0A$

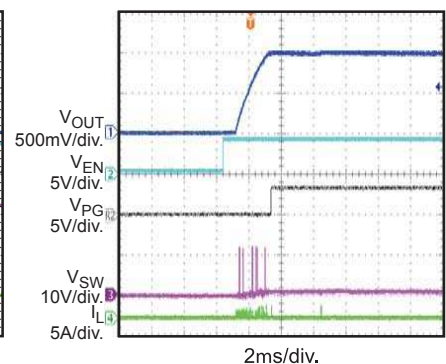

EVB TEST RESULTS (continued)

Performance waveforms are tested on the evaluation board.

$V_{IN} = 12V$, $V_{OUT} = 1V$, $L = 1.5\mu H$, $F_S = 500kHz$, Auto PFM/PWM mode, $T_A = 25^\circ C$, unless otherwise noted.

Start-Up through EN

$I_{OUT} = 12A$

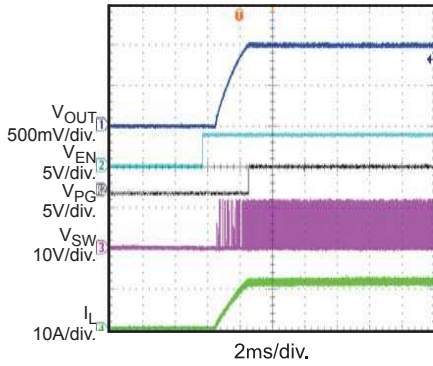

Shutdown through EN

$I_{OUT} = 0A$

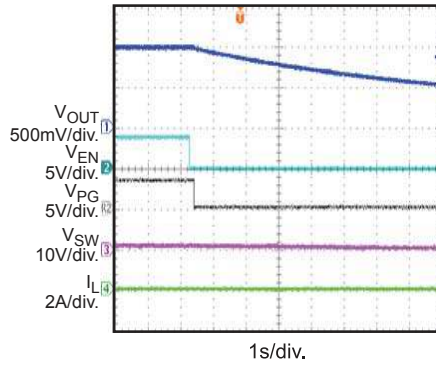

Shutdown through EN

$I_{OUT} = 12A$

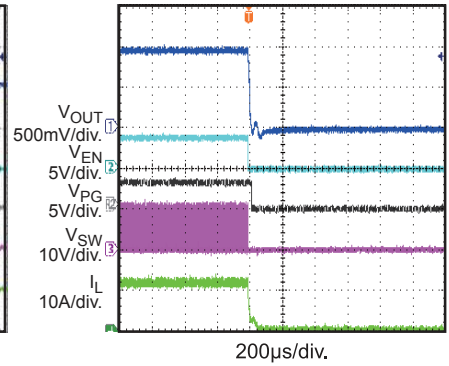

Load Transient

$I_{OUT} = 6A-12A$

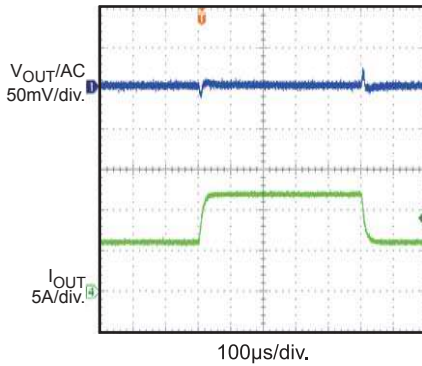

I²C Control Slew Rate

$I_{OUT}=0A$, Slew Rate=20mV/µs, PWM Mode, Output from 0.9V to 1.2V

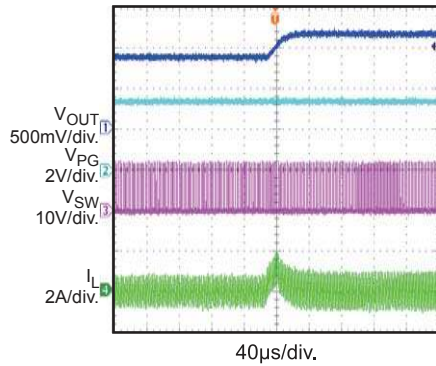

I²C Control Slew Rate

$I_{OUT}=0A$, Slew Rate=20mV/µs, PWM Mode, Output from 1.2V to 0.9V

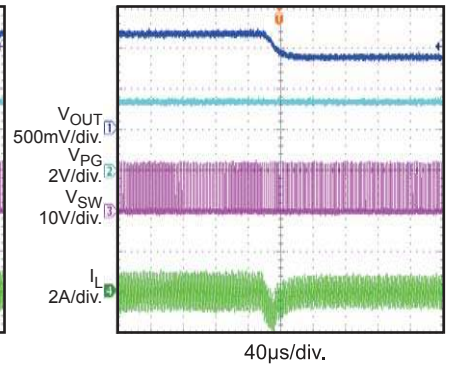

I²C Control Slew Rate

$I_{OUT}=12A$, Slew Rate=20mV/µs, PWM Mode, Output from 0.9V to 1.2V

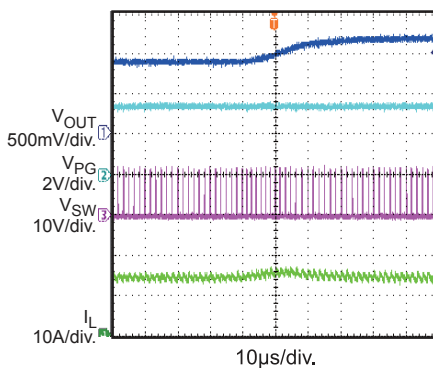

I²C Control Slew Rate

$I_{OUT}=12A$, Slew Rate=20mV/µs, PWM Mode, Output from 1.2V to 0.9V

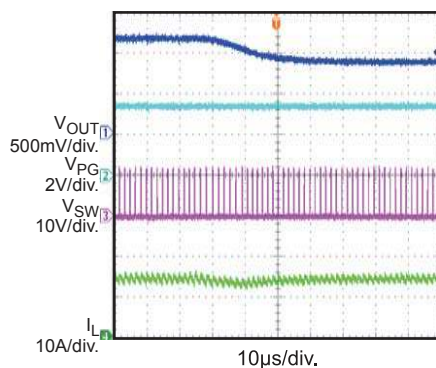

Short-Circuit Protection Entry

$I_{OUT} = 0A$

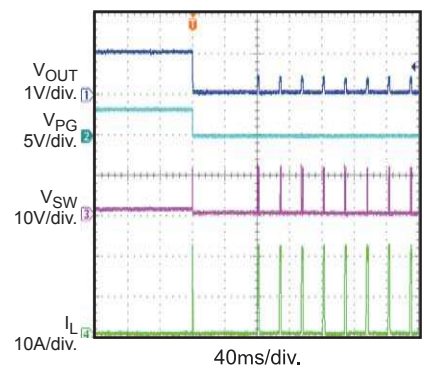

EVB TEST RESULTS *(continued)*

Performance waveforms are tested on the evaluation board.

$V_{IN} = 12V$, $V_{OUT} = 1V$, $L = 1.5\mu H$, $F_S = 500kHz$, Auto PFM/PWM mode, $T_A = 25^\circ C$, unless otherwise noted.

Short-Circuit Protection Recovery
 $I_{OUT} = 0A$

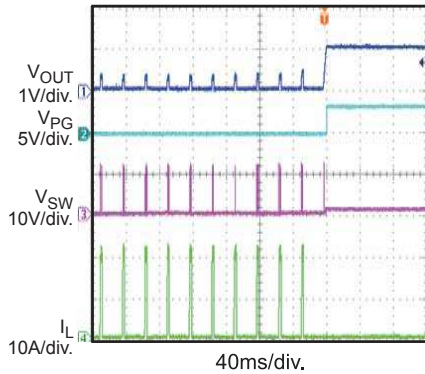

Short-Circuit Protection Steady State
 Short Output to GND

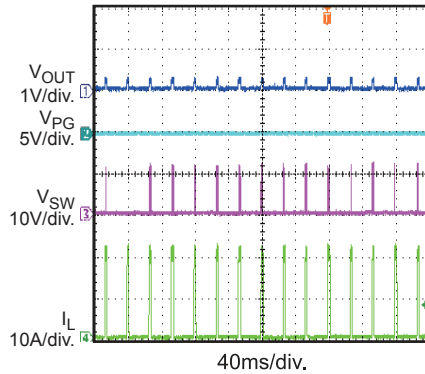

Short-Circuit Protection Entry, Latch Off Mode
 $I_{OUT} = 0A$

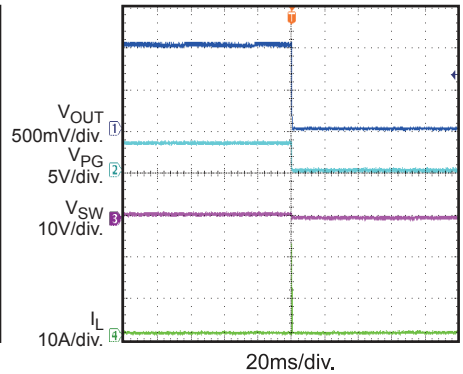

PRINTED CIRCUIT BOARD LAYER

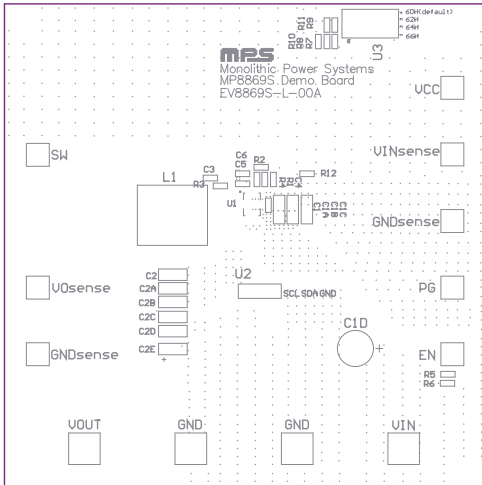

Figure 1: Top Silk Layer

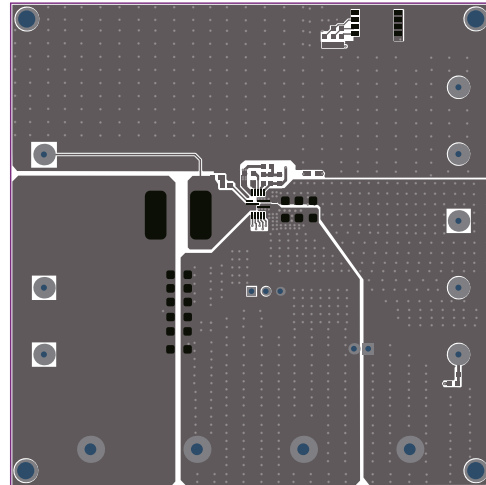

Figure 2: Top Layer

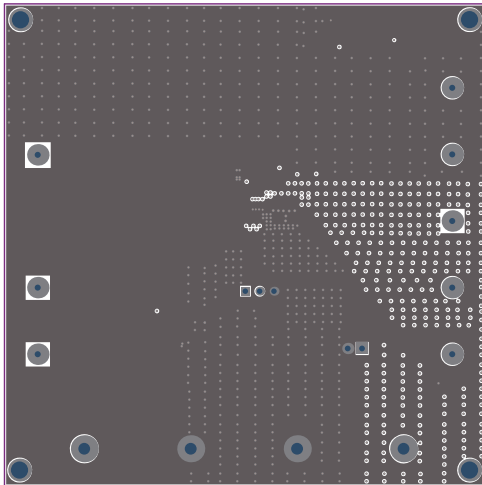

Figure 3: Inner 1 Layer

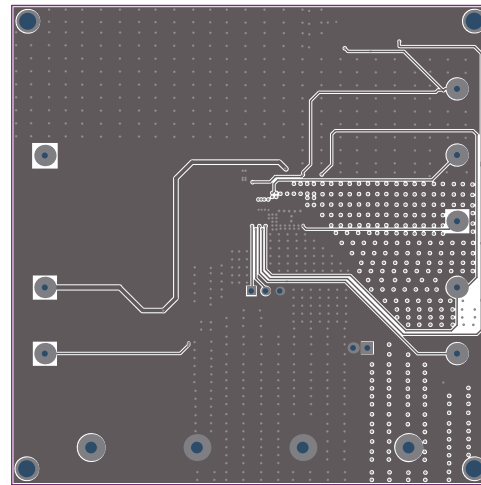

Figure 4: Inner 2 Layer

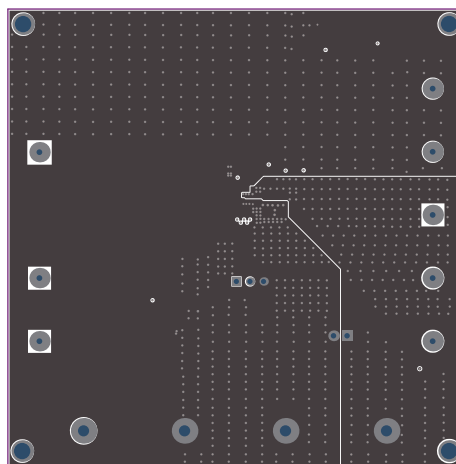

Figure 5: Bottom Layer

QUICK START GUIDE

1. Connect the positive and negative terminals of the load to the VOUT and GND pins, respectively.
2. Preset the power supply output between 2.85V and 18V, and then turn off the power supply.
3. Connect the positive and negative terminals of the power supply output to the VIN and GND pins, respectively.
4. Turn the power supply on. The board will automatically start up.
5. To use the Enable function, apply a digital input to the EN pin. Drive EN higher than 1.3V to turn on the regulator, or less than 0.99V to turn it off.
6. To program I²C function, connect SCL, SDA and GND to I²C start kit board. Connect I²C start kit board to computer and run MP8869S GUI software to program MP8869S I²C register.

NOTICE: The information in this document is subject to change without notice. Please contact MPS for current specifications. Users should warrant and guarantee that third party Intellectual Property rights are not infringed upon when integrating MPS products into any application. MPS will not assume any legal responsibility for any said applications.