

Product Range



Rotary Switches

- **Wire hooking versions:**
MRC Series
- **PCB versions:**
MRJ and 6000 Series

Main features:

- Adjustable stop on 1, 2 and 3 pole
- Different output coding
- Wiping contacts
- Metal shaft
- with or without knob
- PCB terminal versions
- Splashproof versions

Rotary Switches



MRC Series, 500m Amppage 12



MRJ Series, 0.4 VApage 15



6000 Seriespage 18

MRC Series, 500m Amp

Features

- 36° throw
- Adjustable stop on 1, 2, and 3 pole
- Insert molded terminals
- Wiping contacts



Typical performance characteristics

Contact timing non-shorting
 Contact rating 500 mA @ 125 VAC or 28 VDC resistive
 Electrical life up to 10,000 cycles @ full contact rating
 up to 25,000 cycles @ 150 mA @125 VAC
 or 250 mA @ 28 VDC
 Contact resistance, initial 50 mOhms max.
 Insulation resistance 100 MOhms min.
 Dielectric strength 1,000 Vrms @ sea level
 Rotation torque 9.8 Ncm max
 Plunger/actuator travel 36°

Environmental specification

Operating temperature -20°C to 80°C
 Storage temperature -20°C to 100°C
 Solder heat resistance manual: 270°C for 3 seconds
 wave: 245°C for 3 seconds

Material specifications

Contacts silver
 Case material aluminum
 Actuator material brass
 Terminals/fixed contacts silver plated brass
 Terminal seal insert molded, DAP base
 Bushing nickel plated brass

Product key		Typical product key		MRC	110	04
Type						
MRC	Rotary switches, 500m Amp					
Number of poles, positions						
110	1 pole, 2 to 10 positions	33	3 poles, 2 to 3 positions			
25	2 poles, 2 to 5 positions	42	4 poles, 2 positions (fixed)			
Knob						
S	shaft, no knob	blank	knob included			
Material						
04	RoHS compliant					

MRC Series, 500m Amp (Continued)

Number of poles, positions



110 1 pole, 2-10 positions, shaft without knob



MRC110S04

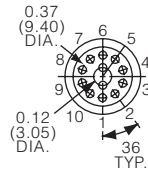

* Two common terminals are internally shorted. Use either one.

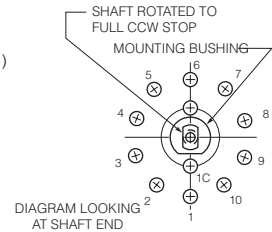
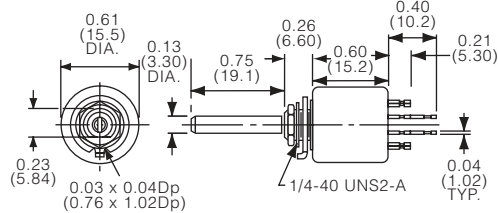

110 1 pole, 2-10 positions, with knob



MRC11004

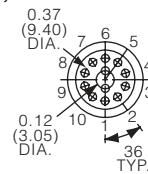

* Two common terminals are internally shorted. Use either one.

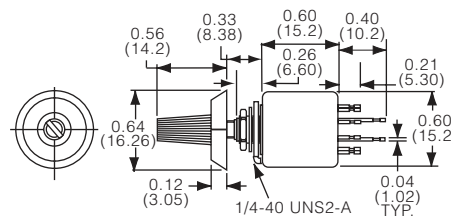

Knob not sold separately

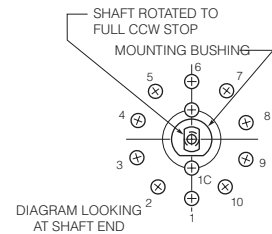

25 2 pole, 2-5 positions, shaft without knob



MRC25S04

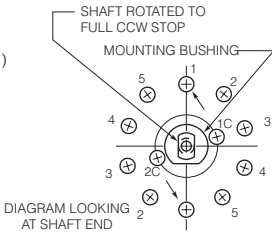
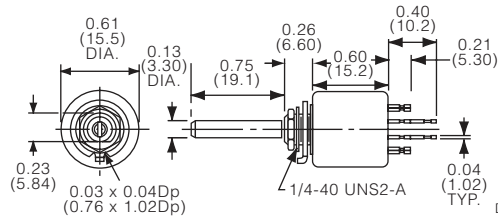
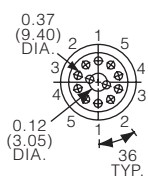

25 2 pole, 2-5 positions, with knob



MRC2504

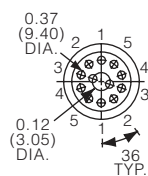

Knob not sold separately

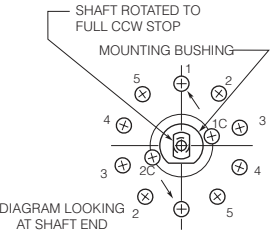
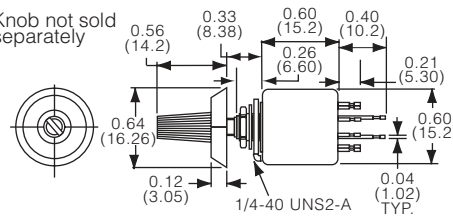

33 3 pole, 2-3 positions, shaft without knob



MRC33S04

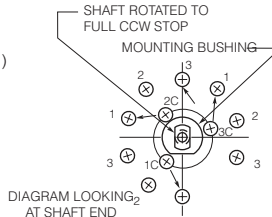
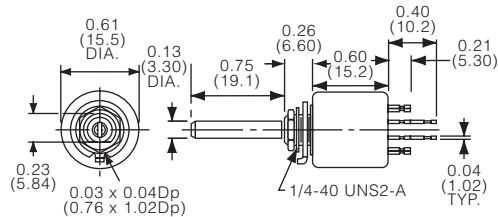
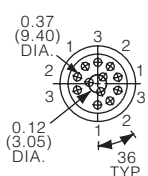

MRC Series, 500m Amp (Continued)

33 3 pole, 2-3 positions, with knob



MRC3304

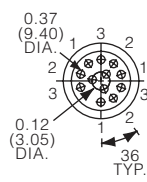

Knob not sold separately

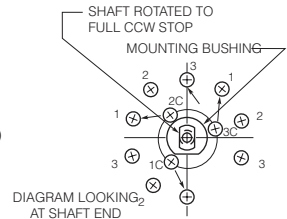
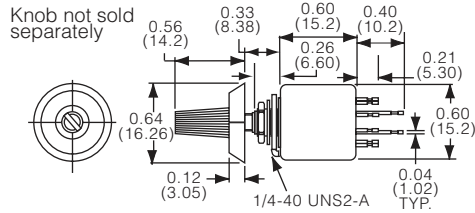

42 4 pole, 2 positions, shaft without knob



MRC42S04

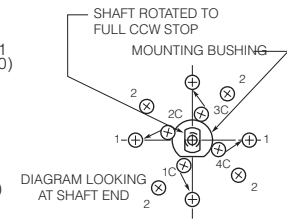
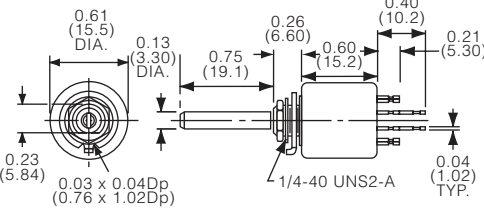
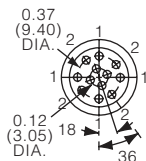

42 4 pole, 2 positions, with knob



MRC4204

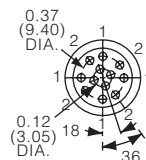

Knob not sold separately

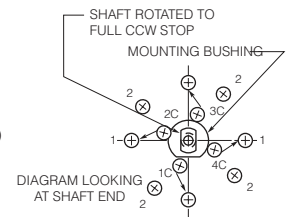
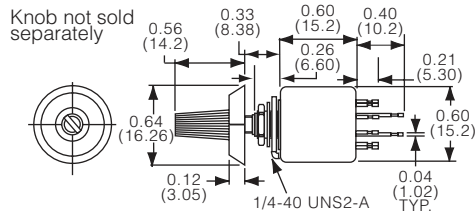

Mounting

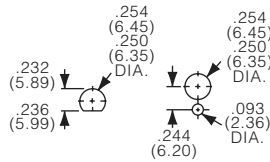

Product key	Poles	Positions	Knob	Part Number
MRC11004	1 pole	2 to 10	yes	1825495-1
MRC110S04			no	1825496-1
MRC2504	2 pole	2 to 5	yes	1825497-1
MRC25S04			no	1825498-1
MRC3304	3 pole	2 to 3	yes	1825499-1
MRC33S04			no	1825500-1
MRC4204	4 pole	2 (fixed)	yes	1825501-1
MRC42S04			no	1825502-1

MRJ Series, 0.4 VA

Features

- 30° throw
- PC mount
- Splashproof versions



Typical performance characteristics

Contact timing non-shorting
 Contact rating 0.4 VA max. @ 20 VDC or peak VAC
 Electrical life up to 10,000 cycles @ full contact rating
 up to 30,000 cycles @ 0.1 mA, 12 VDC
 Contact resistance, initial 30 mOhms max.
 Insulation resistance 10,000 MOhms min.
 Dielectric strength 1,000 Vrms @ sea level
 Rotation torque 100 Nmm (14 inch oz) max.
 Plunger/actuator travel 30°C

Environmental specification

Operating temperature -20°C to 70°C
 Storage temperature -20°C to 70°C
 Solder heat resistance 285°C ± 3°C for 15 seconds

Material specifications

Contacts gold plate over nickel plate
 Case material zinc die cast
 Actuator material brass
 Terminals/fixed contacts gold plated
 Terminal seal molded-in epoxy base
 Process seal MRJB and MRJE

Product key

Typical product key

MRJ B 112 04

Type

MRJ Rotary switches, 0.4 VA

Actuator shaft

blank standard shaft
E standard shaft, splashproof
B screwdriver slot, splashproof

Number of poles, positions

standard
112 1 pole, 2 to 12, adjustable or continuous rotation
26 2 poles, 2 to 6, adjustable
34 3 poles, 2 to 4, adjustable
43 4 poles, 2 to 3, adjustable
splashproof
112 1 pole, 12 continuous rotation (splashproof)
26 2 poles, 6 fixed (splashproof)
34 3 poles, 4 fixed (splashproof)
43 4 poles, 3 fixed (splashproof)

Material

04 RoHS compliant

MRJ Series, 0.4 VA (Continued)

Actuator shaft



blank standard shaft, adjustable



MRJ2604

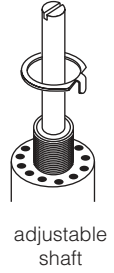
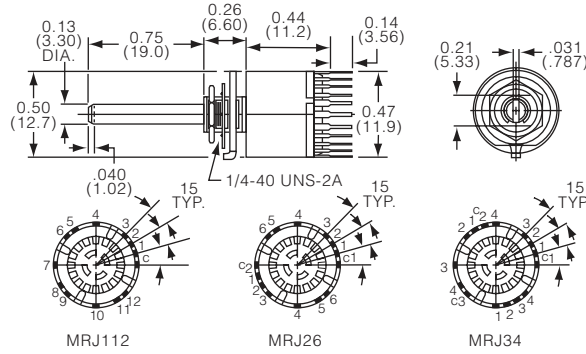

adjustable shaft

E standard shaft, splashproof



MRJE2604

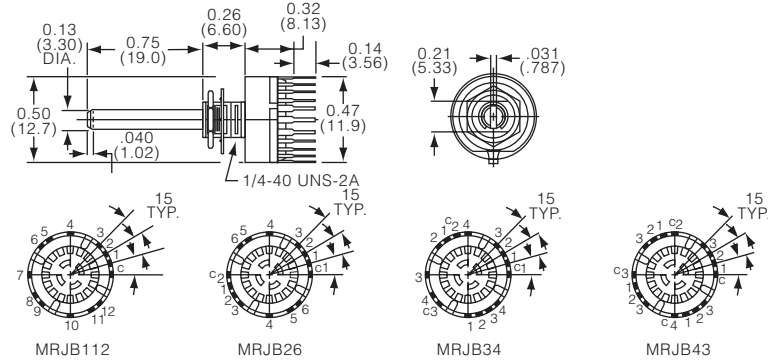

B screwdriver slot, splashproof



MRJB2604

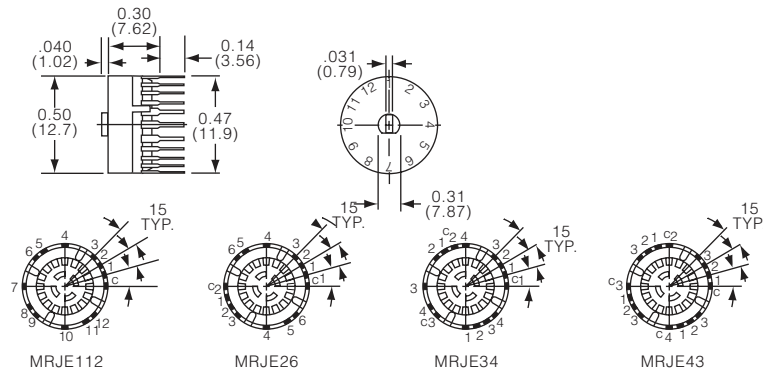

Mounting

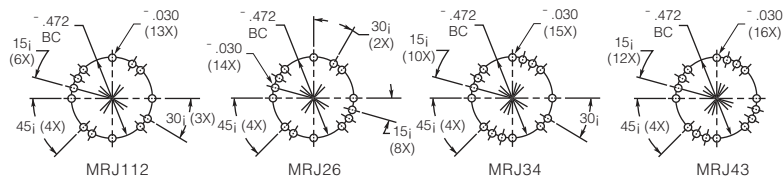

MRJ Series, 0.4 VA (Continued)

Mounting

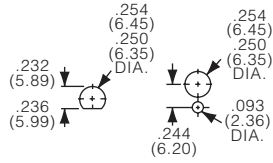

Product key	Actuator shaft	Poles	Positions	Pos. conditions	Part Number
MRJ11204	standard shaft	1 pole	2 to 12 or 12	adjustable or cont. rot.	1825535-1
MRJ2604		2 pole	2 to 6		adjustable
MRJ3404		3 pole	2 to 4		1825535-3
MRJ4304		4 pole	2 to 3		1825535-4
MRJB11204	standard shaft	1 pole	12	continous rotation	1825536-1
MRJB2604	splashproof	2 pole	6	fixed	1825536-2
MRJB3404		3 pole	4		1825536-3
MRJB4304		4 pole	3		1825536-4
MRJE11204	screwdriver slot splashproof	1 pole	12	continous rotation	1825537-1
MRJE2604		2 pole	6		fixed
MRJE3404		3 pole	4		1825537-3
MRJE4304		4 pole	3		1825537-4

6000 Series

Features

- Compact design
- Positive detent action
- Variety of outputs
- Large readable characters



Typical performance characteristics

Contact timing non-shorting
 Contact rating 0.4 VA max. @ 20 VDC or peak VAC
 Electrical life 10,000 cycles @ full contact rating
 30,000 cycles @ 0.1 mA, 12 VDC
 Contact resistance, initial 30 mOhms max.
 Insulation resistance 10,000 MOhms min.
 Dielectric strength 1,000 Vrms @ sea level
 Rotation torque 100 Nmm (14 inch oz) max.
 Plunger/actuator travel 30°
 Product specification 108-7514
 Instruction sheet 408-7523
 Application specification 114-7005

Environmental specification

Operating temperature -18°C to 88°C
 Storage temperature -45°C to 88°C
 Humidity +40°C and 95% RH for 96 hours

Material specifications

Contacts phosphor bronze, gold over nickel plated
 Solder tabs and pins beryllium copper, tin plated
 Coded switches beryllium copper, tin plated
 Single pole switches brass, tin plated
 Structural parts thermoplastic

6000 Series, rotary switches, pc mount

8 position, binary coded octal (BCO) Part Numbers 435174-1, 1-435174-1

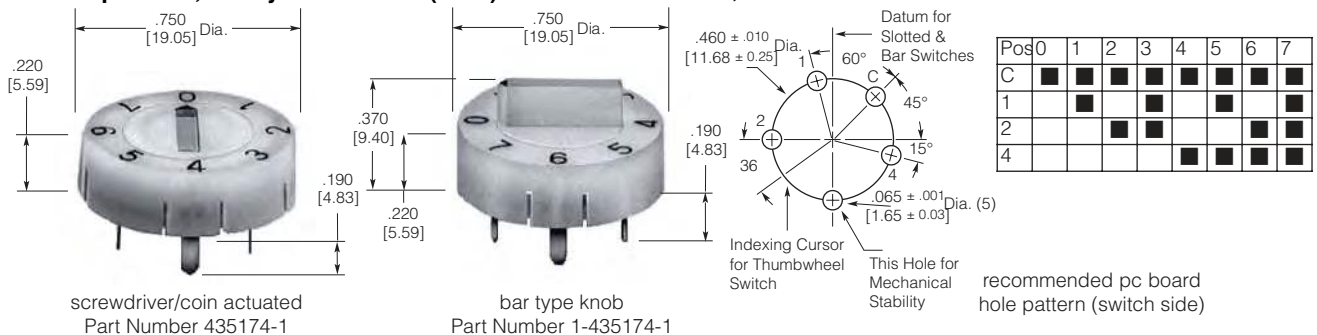

6000 Series (Continued)

10 position, binary coded decimal (BCD) Part Numbers 435005-1, 435123-1, 435128-1



screwdriver/coin actuated
Part Number 435005-1

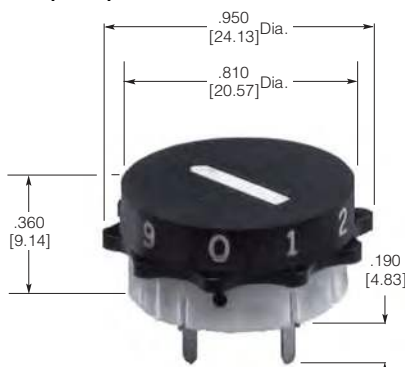

thumbwheel
Part Number 435128-1



bar type knob
Part Number 1-435123-1

recommended pc board hole pattern (switch side)

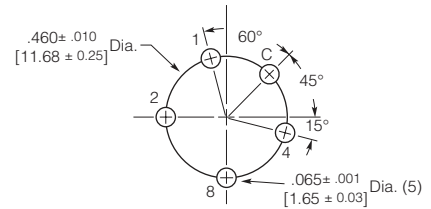

Pos	0	1	2	3	4	5	6	7	8	9
C	■	■	■	■	■	■	■	■	■	■
1		■		■		■		■		■
2			■	■			■	■		
4					■	■	■	■		
8									■	■

10 position, single pole Part Numbers 1-435097-1, 2-435097-1, 435097-1, 435097-2

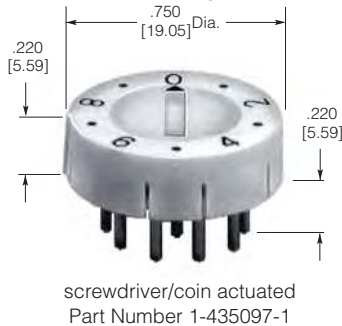

screwdriver/coin actuated
Part Number 1-435097-1

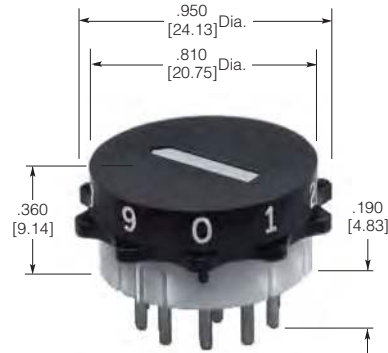

thumbwheel
Part Number 435097-1 (shown)
Part Number 435097-2 (with numbers 1-10)

recommended pc board hole pattern (switch side)

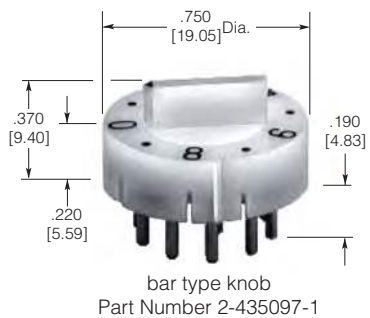
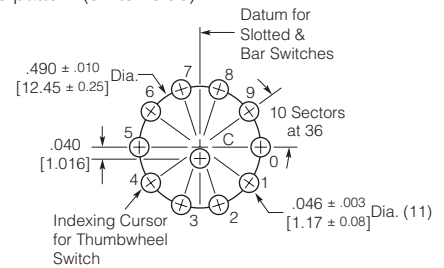

bar type knob
Part Number 2-435097-1

P.	0	1	2	3	4	5	6	7	8	9
C	■	■	■	■	■	■	■	■	■	■
0	■									
1		■								
2			■							
3				■						
4					■					
5						■				
6							■			
7								■		
8									■	
9										■

6000 Series (Continued)

16 position, hexadecimal Part Numbers 1-435167-1, 2-435167-1

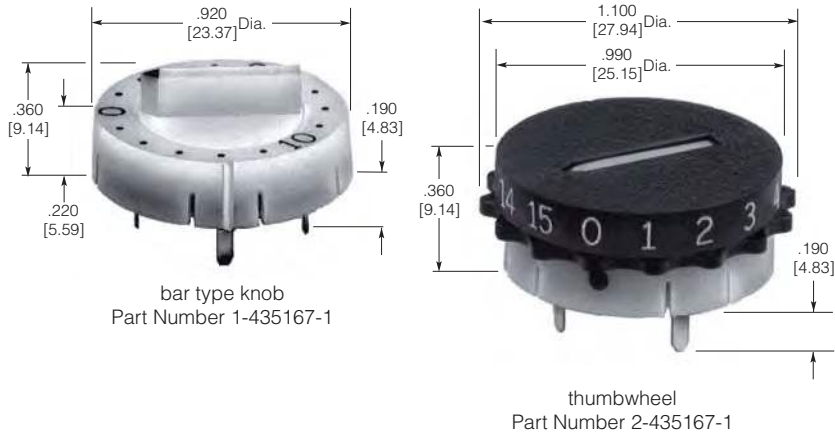

recommended pc board hole pattern (switch side)

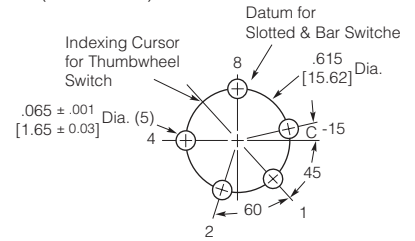

P.	0	1	2	3	4	5	6	7	8	9	10	11	12	13	14	15
C	■	■	■	■	■	■	■	■	■	■	■	■	■	■	■	■
1		■				■				■				■		
2			■	■			■	■			■	■				■
4					■	■							■	■		
8										■	■	■	■	■	■	■

Positions	Actuator type	Coding	Part Number
10	screwdriver/coin	single pole	1-435097-1
16	bar	hexadecimal	1-435167-1
8		binary coded octal	1-435174-1
10		single pole	2-435097-1
16	thumbwheel	hexadecimal	2-435167-1
10	screwdriver/coin	BCD	435005-1
10	thumbwheel	single pole	435097-1
10	bar	BCD	435123-1
8	screwdriver/coin	binary coded octal	435174-1