

PART NUMBER
134-1000-038

REV	ECO	DATE
1	INITIAL RELEASE	04SEP2020

NOTES:

1. MATERIAL AND FINISH:

- 1.1 BODY: STAINLESS STEEL, PASSIVATED
- 1.2 CONTACT: BERYLLIUM COPPER, GOLD PLATE
- 1.3 INSULATOR: ULTEM 1000, AMBER

2. ELECTRICAL SPECIFICATIONS:

- 2.1 IMPEDANCE: 50 OHMS NOMINAL
- 2.2 FREQUENCY RANGE: DC~50 GHz
- 2.3 VSWR: 1.30 MAX
- 2.4 DIELECTRIC WITHSTANDING VOLTAGE: 250 VRMS MIN
- 2.5 INSULATION RESISTANCE: 3500 MEGOHM MIN
- 2.6 CONTACT RESISTANCE:
 - 2.6.1 CENTER CONTACT - 6.0 MILLIOHM MAX
 - 2.6.2 OUTER CONDUCTOR - 2.0 MILLIOHM MAX

3. MECHANICAL SPECIFICATIONS:

- 3.1 ENGAGE/DISENGAGE FORCE: 0.23 Nm MAX (2.4MM)
2.5 LBS MAX/4.5 LBS MAX (SMP3)
- 3.2 CONTACT RETENTION: 20 N MIN
- 3.3 DURABILITY: 500 CYCLES MIN (2.4MM)
100 CYCLES MIN (SMP3)

4. ENVIRONMENTAL:

- (MEETS OR EXCEEDS THE APPLICABLE PARAGRAPH OF MIL-PRF-39012)
- 4.1 THERMAL SHOCK: MIL-STD-202, METHOD 107, CONDITION B
- 4.2 OPERATING TEMPERATURE: -65°C TO 165°C
- 4.3 MOISTURE RESISTANCE: MIL-STD-202, METHOD 106
- 4.4 MECHANICAL SHOCK: MIL-STD-202, METHOD 213, CONDITION I
- 4.5 VIBRATION: MIL-STD-202, METHOD 204, CONDITION D

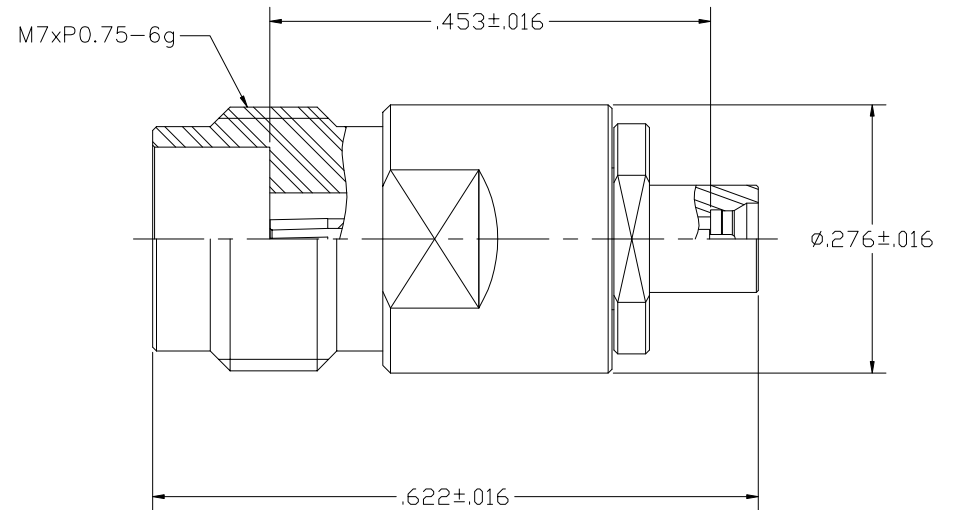

 <p>This PROPRIETARY Document is property of Cinch Connectivity Solutions. It is confidential in nature, non-transferable, and leased with the clear understanding that it is not traced or copied without permission and is returnable upon demand.</p> <p>INTERPRET DRAWING IN ACCORDANCE WITH ASME Y14.5-2009.</p>	Model No:	134-1000-038	JOHNSON	
	RoHS <input checked="" type="checkbox"/>	Cage Code	Title: ADAPTER ASSEMBLY, 2.4MM FEMALE TO SMP3 MALE	
	(EU)2015/863 COMPLIANT	3RD ANGLE PROJECTION	Drawing No.	REV.
	UNLESS OTHERWISE SPECIFIED UNITS: INCH	Drawn by: TOMMY REN	134-1000-038	1
	Date: 09/04/2020	Size B	DO NOT SCALE DRAWING	Workmanship Std: NONE
	ANGLES ±5°			Sheet 1 OF 1