

SAC-4P-M12MS/3,0-544/M12FS BK - Sensor/actuator cable



1326630

<https://www.phoenixcontact.com/us/products/1326630>

Please be informed that the data shown in this PDF document is generated from our online catalog. Please find the complete data in the user documentation. Our general terms of use for downloads are valid.



Sensor/actuator cable, 4-position, PVC, gray, Plug straight M12, coding: A, on Socket straight M12, coding: A, cable length: 3 m

Commercial data

Item number	1326630
Packing unit	1 pc
Sales key	BF13
Product key	BF1ICB
GTIN	4063151618032
Weight per piece (including packing)	22.22 g
Weight per piece (excluding packing)	22.22 g
Country of origin	US

SAC-4P-M12MS/3,0-544/M12FS BK - Sensor/actuator cable



1326630

<https://www.phoenixcontact.com/us/products/1326630>

Technical data

Product properties

Product type	Sensor/actuator cable
Number of positions	4
Application	Standard, U.S. cables
No. of cable outlets	1
Shielded	no
Coding	A

Insulation characteristics

Overvoltage category	II
Degree of pollution	3

Material specifications

Flammability rating according to UL 94	HB
Seal material	NBR
Material of grip body	TPU, hardly inflammable, self-extinguishing
Contact material	CuSn
Contact surface material	Ni/Au
Contact carrier material	TPU GF
Material for screw connection	Zinc die-cast, nickel-plated
Outer sheath, material	PVC

Electrical properties

Contact resistance	$\leq 5 \text{ m}\Omega$
Insulation resistance	$\geq 10 \text{ M}\Omega$
Nominal voltage U_N	250 V AC
	250 V DC
Nominal current I_N	4 A
Protective circuit	unwired

Mechanical properties

Mechanical data

Insertion/withdrawal cycles	≥ 100
-----------------------------	------------

Signaling

Status display	No
Status display present	No

Connection data

Conductor connection

Tightening torque	0.4 Nm (M12 connector)
-------------------	------------------------

SAC-4P-M12MS/3,0-544/M12FS BK - Sensor/actuator cable



1326630

<https://www.phoenixcontact.com/us/products/1326630>

Connector

Connection 1

Type	Plug straight M12
Number of positions	4
Coding type	A
Number of positions	4

Connection 2

Type	Socket straight M12
Number of positions	4
Coding type	A
Number of positions	4

Cable/line

Cable length	3 m
--------------	-----

PVC gray 105 °C [544]

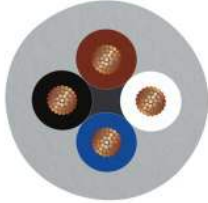
Dimensional drawing	
Cable weight	40 kg/km
UL AWM Style	2517 (105 °C / 300 V)
Number of positions	4
Cable type	PVC gray 105 °C [544]
Conductor structure signal line	30x 1.30 mm
AWG signal line	22
Wire diameter incl. insulation	1.27 mm ±0.03 mm
External cable diameter	5 mm ±0.2 mm
Outer sheath, material	PVC
External sheath, color	gray
Conductor material	Tin-plated Cu litz wires
Material wire insulation	PVC
Single wire, color	brown, white, blue, black
Overall twist	3 wires, twisted
Max. conductor resistance	max. 50.5 Ω/km (20 °C)
Insulation resistance	≥ (550 M Ohms/m @ 500V)
Nominal voltage, cable	300 V
Minimum bending radius, flexible installation	12 x D

SAC-4P-M12MS/3,0-544/M12FS BK - Sensor/actuator cable



1326630

<https://www.phoenixcontact.com/us/products/1326630>

Flame resistance	FT4
Other resistance	UV resistant
Special properties	UL standards PLTC and ITC
Ambient temperature (operation)	-30 °C ... 105 °C (cable, fixed installation)
	-5 °C ... 105 °C (Cable, flexible installation)
	-30 °C ... 105 °C (cable, fixed installation)

Environmental and real-life conditions

Ambient conditions

Degree of protection	IP65
	IP67
	IP68
Ambient temperature (operation)	-25 °C ... 90 °C (Plug / socket)

Standards and regulations

Standard designation	M12 connector
Standards/specifications	IEC 61076-2-101

SAC-4P-M12MS/3,0-544/M12FS BK - Sensor/actuator cable



1326630

<https://www.phoenixcontact.com/us/products/1326630>

Drawings

Schematic diagram

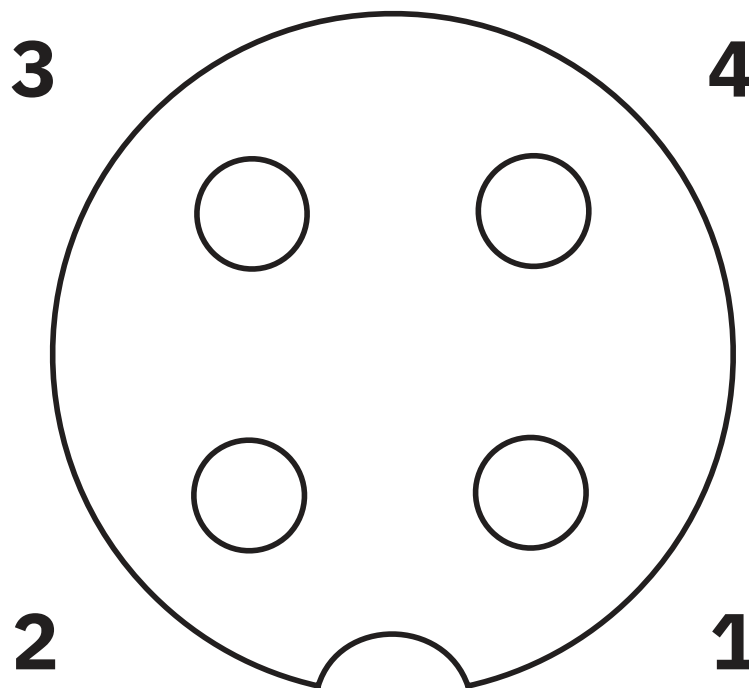

Pin assignment M12 socket, 4-pos., A-coded, view female side

SAC-4P-M12MS/3,0-544/M12FS BK - Sensor/actuator cable



1326630

<https://www.phoenixcontact.com/us/products/1326630>

Dimensional drawing

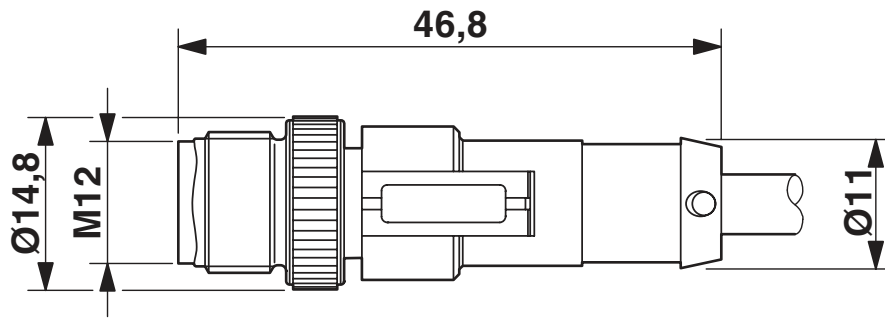

Plug, M12 x 1, straight, shielded

Dimensional drawing

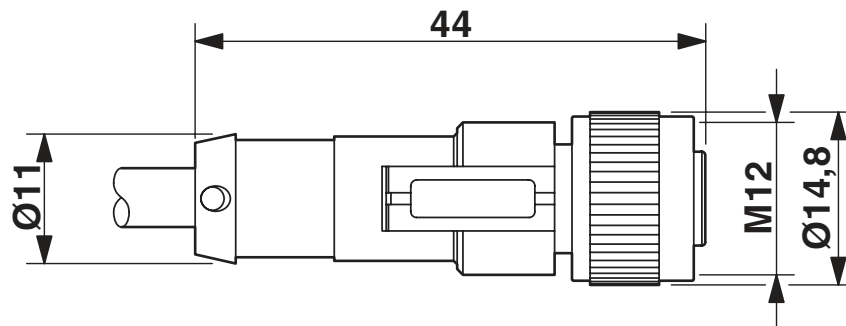

M12 x 1 socket, straight

SAC-4P-M12MS/3,0-544/M12FS BK - Sensor/actuator cable



1326630

<https://www.phoenixcontact.com/us/products/1326630>

Schematic diagram

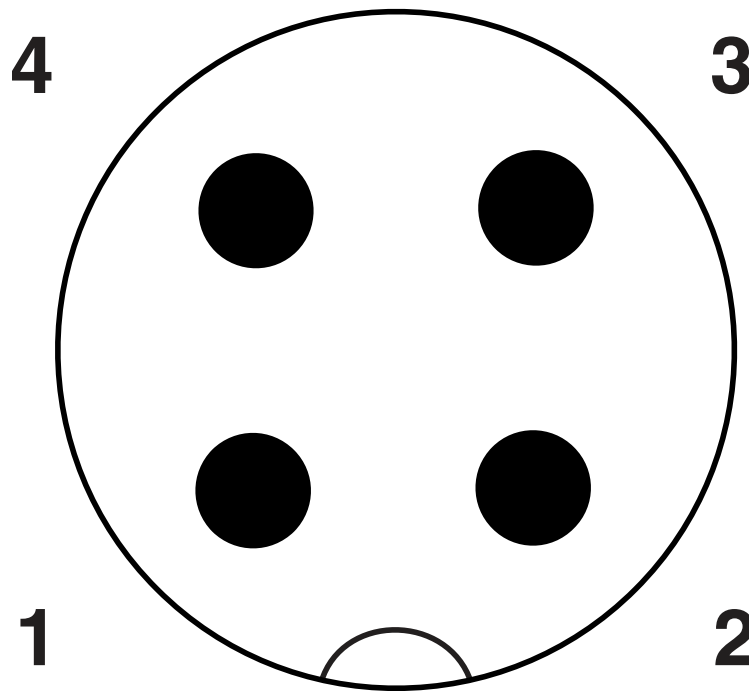

Pin assignment M12 plug, 4-pos., A-coded, view plug side

Circuit diagram

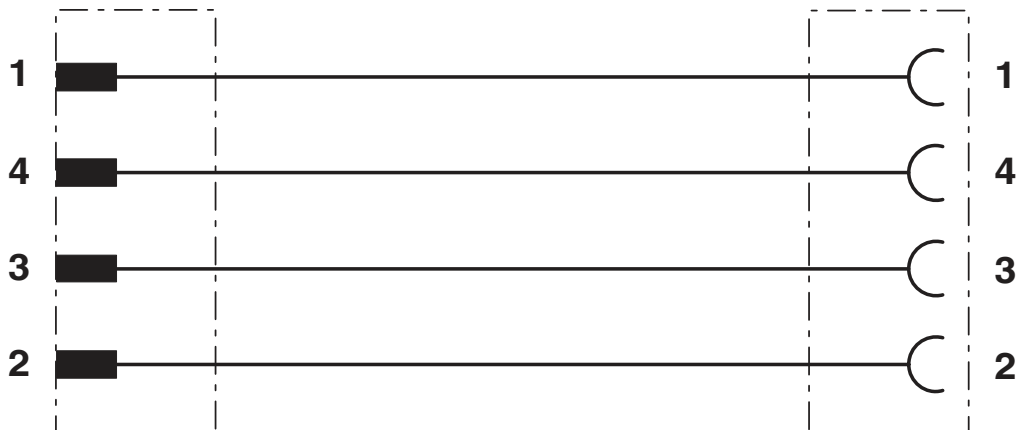

SAC-4P-M12MS/3,0-544/M12FS BK - Sensor/actuator cable



1326630

<https://www.phoenixcontact.com/us/products/1326630>

Classifications

ECLASS

ECLASS-11.0	27060311
ECLASS-12.0	27060311
ECLASS-13.0	27060311

ETIM

ETIM 8.0	EC001855
----------	----------

SAC-4P-M12MS/3,0-544/M12FS BK - Sensor/actuator cable



1326630

<https://www.phoenixcontact.com/us/products/1326630>

Accessories

PROT-M12 FS-PA-CHAIN - Sealing cap

1430873

<https://www.phoenixcontact.com/us/products/1430873>

M12 sealing cap made of plastic with fixing band, for sensor cables, for free M12 plugs



SAC-M12-EXCLIP-M - Locking clip

1558988

<https://www.phoenixcontact.com/us/products/1558988>

Locking clip for the pin side of sensor/actuator cables with M12 connector and M12 connectors for assembly, for knurl diameter: 15 mm or for Allen key with a wrench size of 14 mm, prevents the disconnection of plug-in connections without tools



SAC-4P-M12MS/3,0-544/M12FS BK - Sensor/actuator cable



1326630

<https://www.phoenixcontact.com/us/products/1326630>

PROT-M12 MS-PA-CHAIN - Screw plug

1430899

<https://www.phoenixcontact.com/us/products/1430899>

M12 sealing cap with fixing band, for sensor cables, for free M12 sockets



SAC-M12-EXCLIP-F - Locking clip

1558991

<https://www.phoenixcontact.com/us/products/1558991>

Locking clip for the socket side of sensor/actuator cables with M12 connector and M12 connectors for assembly, for knurl diameter: 15 mm or for Allen key with a wrench size of 14 mm, prevents the disconnection of plug-in connections without tools



SAC-4P-M12MS/3,0-544/M12FS BK - Sensor/actuator cable



1326630

<https://www.phoenixcontact.com/us/products/1326630>

TSD 04 SAC - Torque screwdriver

1208429

<https://www.phoenixcontact.com/us/products/1208429>



Torque screwdriver, with preset torque of 0.4 Nm and 4 mm hexagonal drive for M12 connectors

TSD-M 1,2NM - Torque screwdriver

1212224

<https://www.phoenixcontact.com/us/products/1212224>



Torque screw driver, accuracy as per EN ISO 6789 standard, adjustable from 0.3 - 1.2 Nm

SAC-4P-M12MS/3,0-544/M12FS BK - Sensor/actuator cable



1326630

<https://www.phoenixcontact.com/us/products/1326630>

TSD-M SAC-BIT ADAPTER - Adapter insert

1212600

<https://www.phoenixcontact.com/us/products/1212600>



Adapter bit for TSD-M...torque tools, E6.3-1/4" drive with 4 mm hexagon to accommodate SAC bits

SAC BIT M12-D15 - Tool

1208432

<https://www.phoenixcontact.com/us/products/1208432>



Nut for assembling sensor/actuator cables with M12 connector and M12 connectors for assembly, with a knurl diameter of 15 mm, for 4 mm hexagonal drive

Phoenix Contact 2023 © - all rights reserved
<https://www.phoenixcontact.com>

Phoenix Contact USA
586 Fulling Mill Road
Middletown, PA 17057, United States
(+717) 944-1300
info@phoenixcon.com