

FEATURES

- Current sink: 120 mA
- 2-wire, (I²C-compatible) 1.8 V serial interface
- 10-bit resolution
- Integrated current sense resistor
- Power supply: 2.7 V to 5.5 V
- Guaranteed monotonic over all codes
- Power down to: 0.5 μ A typical
- Internal reference
- Ultralow noise preamplifier
- Power-down function
- Power-on reset
- Available in 3 \times 3 array WLCSP package

APPLICATIONS

Consumer

- Lens autofocus
- Image stabilization
- Optical zoom
- Shutters
- Iris/exposure
- Neutral density (ND) filters
- Lens covers
- Camera phones
- Digital still cameras
- Camera modules
- Digital video cameras/camcorders
- Camera-enabled devices
- Security cameras
- Web/PC cameras

Industrial

- Heater control
- Fan control
- Cooler (Peltier) control
- Solenoid control
- Valve control
- Linear actuator control
- Light control
- Current loop control

GENERAL DESCRIPTION

The AD5398A is a single, 10-bit digital-to-analog converter (DAC) with a current sink output capability of 120 mA. This device features an internal reference and operates from a single 2.7 V to 5.5 V supply. The DAC is controlled via a 2-wire (1.8 V, I²C[®]-compatible) serial interface that operates at clock rates up to 400 kHz.

The AD5398A incorporates a power-on reset circuit, which ensures the DAC output powers up to 0 V and remains there until a valid write takes place. It has a power-down feature that reduces the current consumption of the device to 0.5 μ A typically.

The AD5398A is designed for autofocus, image stabilization, and optical zoom applications in camera phones, digital still cameras, and camcorders. The AD5398A is also suitable for many industrial applications, such as controlling temperature, light, and movement without derating, over temperatures ranging from -30°C to $+85^{\circ}\text{C}$. The I²C address range for the AD5398A is 0x18 to 0x1F inclusive.

FUNCTIONAL BLOCK DIAGRAM

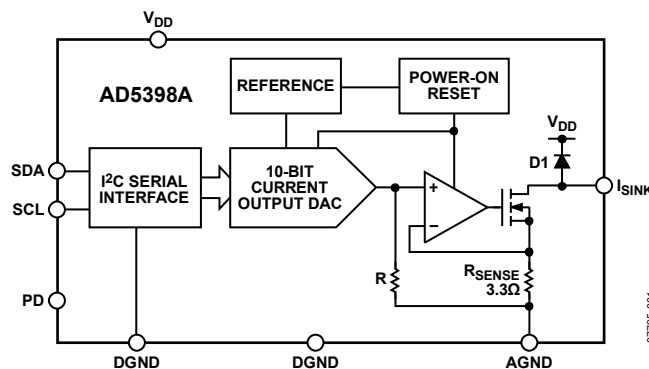

Figure 1.

Rev. 0

Information furnished by Analog Devices is believed to be accurate and reliable. However, no responsibility is assumed by Analog Devices for its use, nor for any infringements of patents or other rights of third parties that may result from its use. Specifications subject to change without notice. No license is granted by implication or otherwise under any patent or patent rights of Analog Devices. Trademarks and registered trademarks are the property of their respective owners.

AD5398A* Product Page Quick Links

Last Content Update: 08/30/2016

[Comparable Parts](#)

View a parametric search of comparable parts

[Documentation](#)

Data Sheet

- AD5398A: 120 mA, Current Sinking, 10-Bit, I²C DAC Data Sheet

[Reference Materials](#)

Solutions Bulletins & Brochures

- Digital to Analog Converters ICs Solutions Bulletin

[Design Resources](#)

- AD5398A Material Declaration
- PCN-PDN Information
- Quality And Reliability
- Symbols and Footprints

[Discussions](#)

View all AD5398A EngineerZone Discussions

[Sample and Buy](#)

Visit the product page to see pricing options

[Technical Support](#)

Submit a technical question or find your regional support number

* This page was dynamically generated by Analog Devices, Inc. and inserted into this data sheet. Note: Dynamic changes to the content on this page does not constitute a change to the revision number of the product data sheet. This content may be frequently modified.

TABLE OF CONTENTS

Features	1	Pin Configuration and Function Descriptions.....	6
Consumer Applications	1	Typical Performance Characteristics	7
Industrial Applications	1	Terminology	9
General Description	1	Theory of Operation	10
Functional Block Diagram	1	Serial Interface	10
Revision History	2	I ² C Bus Operation	10
Specifications.....	3	Data Format	11
AC Specifications.....	4	Power Supply Bypassing and Grounding.....	12
Timing Specifications	4	Applications Information	13
Absolute Maximum Ratings.....	5	Outline Dimensions	14
ESD Caution.....	5	Ordering Guide	14

REVISION HISTORY

10/08—Revision 0: Initial Version

SPECIFICATIONS

$V_{DD} = 2.7\text{ V to }5.5\text{ V}$, $AGND = DGND = 0\text{ V}$, load resistance (R_L) = $25\ \Omega$ connected to V_{DD} ; all specifications T_{MIN} to T_{MAX} , unless otherwise noted.

Table 1.

Parameter	B Version ¹			Unit	Test Conditions/Comments
	Min	Typ	Max		
DC PERFORMANCE					
Resolution		10		Bits	$V_{DD} = 3.6\text{ V to }4.5\text{ V}$; device operates over $2.7\text{ V to }5.5\text{ V}$ with reduced performance
Relative Accuracy ²		± 1.5	± 4	LSB	117 $\mu\text{A}/\text{LSB}$
Differential Nonlinearity ^{2, 3}			± 1	LSB	Guaranteed monotonic over all codes
Zero Code Error ^{2, 4}	0	0.5	1	mA	All 0s loaded to DAC
Offset Error @ Code 16 ²		0.5		mA	
Gain Error ²			± 0.6	% of FSR	at 25°C
Offset Error Drift ^{2, 4, 5}		10		$\mu\text{A}/^\circ\text{C}$	
Gain Error Drift ^{2, 5}		± 0.2	± 0.5	LSB/ $^\circ\text{C}$	
OUTPUT CHARACTERISTICS					
Minimum Sink Current ⁴		3		mA	$V_{DD} = 3.6\text{ V to }4.5\text{ V}$; device operates over $2.7\text{ V to }5.5\text{ V}$; specified maximum sink current may not be achieved
Maximum Sink Current		120		mA	
Output Current During PD ⁵		80		nA	PD = 1
Output Compliance ⁵	0.6		V_{DD}	V	Output voltage range over which maximum 120 mA sink current is available
Output Compliance ⁵	0.48		V_{DD}	V	Output voltage range over which 90 mA sink current is available
Power-Up Time ⁵		20		μs	To 10% of FS, coming out of power-down mode; $V_{DD} = 5\text{ V}$
LOGIC INPUT (PD)⁵					
Input Current			± 1	μA	$V_{DD} = 2.7\text{ V to }5.5\text{ V}$ $V_{DD} = 2.7\text{ V to }5.5\text{ V}$
Input Low Voltage, V_{INL}			0.54	V	
Input High Voltage, V_{INH}	1.26			V	
Pin Capacitance		3		pF	
LOGIC INPUTS (SCL, SDA)⁵					
Input Low Voltage, V_{INL}	-0.3		+0.54	V	$V_{DD} = 2.7\text{ V to }3.6\text{ V}$
Input High Voltage, V_{INH}	1.26		$V_{DD} + 0.3$	V	$V_{DD} = 2.7\text{ V to }3.6\text{ V}$
Input Low Voltage, V_{INL}	-0.3		+0.54	V	$V_{DD} = 3.6\text{ V to }5.5\text{ V}$
Input High Voltage, V_{INH}	1.4		$V_{DD} + 0.3$	V	$V_{DD} = 3.6\text{ V to }5.5\text{ V}$
Input Leakage Current, I_{IN}			± 1	μA	$V_{IN} = 0\text{ V to }V_{DD}$
Input Hysteresis, V_{HYST}	0.05 V_{DD}			V	
Digital Input Capacitance, C_{IN}		6		pF	
Glitch Rejection ⁶			50	ns	Pulse width of spike suppressed
POWER REQUIREMENTS					
V_{DD}	2.7		5.5	V	
I_{DD} (Normal Mode)		0.5	1	mA	I_{DD} specification is valid for all DAC codes; $V_{IH} = V_{DD}$, $V_{IL} = \text{GND}$, $V_{DD} = 5.5\text{ V}$
I_{DD} (Power-Down Mode) ⁷		0.5		μA	$V_{IH} = V_{DD}$, $V_{IL} = \text{GND}$, $V_{DD} = 3\text{ V}$

¹ Temperature range for the B version is -30°C to $+85^\circ\text{C}$.

² See the Terminology section.

³ Linearity is tested using a reduced code range: Code 32 to Code 1023.

⁴ To achieve near zero output current, use the power-down feature.

⁵ Guaranteed by design and characterization; not production tested. PD is active high. SDA and SCL pull-up resistors are tied to 1.8 V.

⁶ Input filtering on both the SCL and SDA inputs suppresses noise spikes that are less than 50 ns.

⁷ PD is active high. When PD is taken high, the AD5389A enters power-down mode.

AD5398A

AC SPECIFICATIONS

$V_{DD} = 2.7\text{ V}$ to 5.5 V , $AGND = DGND = 0\text{ V}$, $R_L = 25\ \Omega$ connected to V_{DD} , unless otherwise noted.

Table 2.

Parameter	B Version ^{1,2}			Unit	Test Conditions/Comments
	Min	Typ	Max		
Output Current Settling Time		250		μs	$V_{DD} = 5\text{ V}$, $R_L = 25\ \Omega$, $L_L = 680\ \mu\text{H}$ $\frac{1}{4}$ scale to $\frac{3}{4}$ scale change (0x100 to 0x300)
Slew Rate		0.3		$\text{mA}/\mu\text{s}$	
Major Code Change Glitch Impulse		0.15		$\text{nA}\cdot\text{sec}$	1 LSB change around major carry
Digital Feedthrough ³		0.06		$\text{nA}\cdot\text{sec}$	

¹ Temperature range for the B version is -30°C to $+85^\circ\text{C}$.

² Guaranteed by design and characterization; not production tested.

³ See the Terminology section.

TIMING SPECIFICATIONS

$V_{DD} = 2.7\text{ V}$ to 5.5 V . All specifications T_{MIN} to T_{MAX} , unless otherwise noted.

Table 3.

Parameter ¹	B Version Limit at T_{MIN} , T_{MAX}	Unit	Description
f_{SCL}	400	kHz max	SCL clock frequency
t_1	2.5	$\mu\text{s min}$	SCL cycle time
t_2	0.6	$\mu\text{s min}$	t_{HIGH} , SCL high time
t_3	1.3	$\mu\text{s min}$	t_{LOW} , SCL low time
t_4	0.6	$\mu\text{s min}$	$t_{HD, STA}$, start/repeated start condition hold time
t_5	100	ns min	$t_{SU, DAT}$, data setup time
t_6^2	0.9	$\mu\text{s max}$	$t_{HD, DAT}$, data hold time
	0	$\mu\text{s min}$	
t_7	0.6	$\mu\text{s min}$	$t_{SU, STA}$, setup time for repeated start
t_8	0.6	$\mu\text{s min}$	$t_{SU, STO}$, stop condition setup time
t_9	1.3	$\mu\text{s min}$	t_{BUF} , bus free time between a stop condition and a start condition
t_{10}	300	ns max	t_R , rise time of both SCL and SDA when receiving
	0	ns min	Can be CMOS driven
t_{11}	250	ns max	t_F , fall time of SDA when receiving
	300	ns max	t_F , fall time of both SCL and SDA when transmitting
	$20 + 0.1 C_b^3$	ns min	
C_b	400	pF max	Capacitive load for each bus line

¹ Guaranteed by design and characterization; not production tested.

² A master device must provide a hold time of at least 300 ns for the SDA signal (referred to the $V_{IH, MIN}$ of the SCL signal) to bridge the undefined region of the SCL falling edge.

³ C_b is the total capacitance of one bus line in pF. t_R and t_F are measured between $0.3 V_{DD}$ and $0.7 V_{DD}$.

Timing Diagram

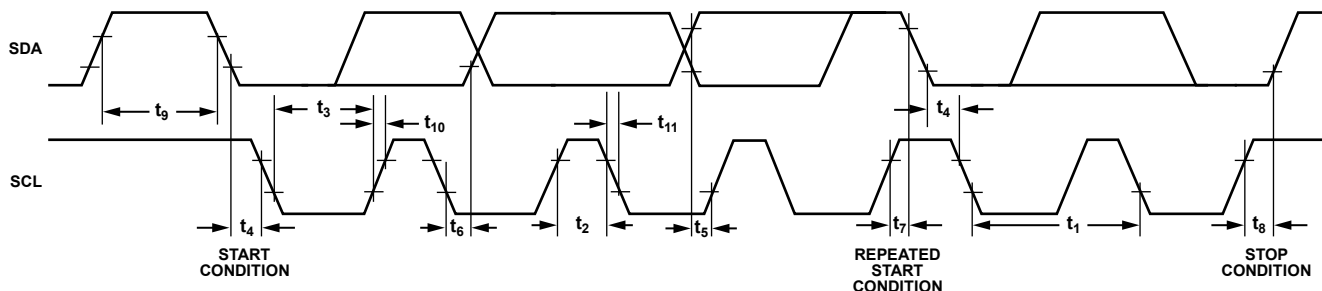

Figure 2. 2-Wire Serial Interface Timing Diagram

07795-002

ABSOLUTE MAXIMUM RATINGS

$T_A = 25^\circ\text{C}$, unless otherwise noted.¹

Table 4.

Parameter	Rating
V_{DD} to AGND	-0.3 V to +7 V
V_{DD} to DGND	-0.3 V to $V_{DD} + 0.3$ V
AGND to DGND	-0.3 V to +0.3 V
SCL, SDA to DGND	-0.3 V to $V_{DD} + 0.3$ V
PD to DGND	-0.3 V to $V_{DD} + 0.3$ V
I_{SINK} to AGND	-0.3 V to $V_{DD} + 0.3$ V
Operating Temperature Range	
Industrial (B Version)	-40°C to +85°C
Storage Temperature Range	-65°C to +150°C
Junction Temperature (T_J max)	150°C
θ_{JA} Thermal Impedance ²	
Mounted on 2-Layer Board	84°C/W
Mounted on 4-Layer Board	48°C/W
Lead Temperature, Soldering	
Maximum Peak Reflow Temperature ³	260°C ($\pm 5^\circ\text{C}$)

¹Transient currents of up to 100 mA do not cause SCR latch-up.

²To achieve the optimum θ_{JA} , it is recommended that the AD5398A be soldered onto a 4-layer board.

³As per JEDEC J-STD-020C.

Stresses above those listed under Absolute Maximum Ratings may cause permanent damage to the device. This is a stress rating only; functional operation of the device at these or any other conditions above those listed in the operational sections of this specification is not implied. Exposure to absolute maximum rating conditions for extended periods may affect device reliability. Only one absolute maximum rating may be applied at any one time.

ESD CAUTION



ESD (electrostatic discharge) sensitive device. Charged devices and circuit boards can discharge without detection. Although this product features patented or proprietary protection circuitry, damage may occur on devices subjected to high energy ESD. Therefore, proper ESD precautions should be taken to avoid performance degradation or loss of functionality.

PIN CONFIGURATION AND FUNCTION DESCRIPTIONS

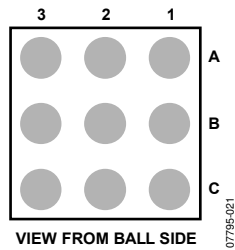

Figure 3. 9-Ball WLCSP Pin Configuration

Table 5. 9-Ball WLCSP Pin Function Description

Pin Number	Mnemonic	Description
A1	I _{SINK}	Output Current Sink.
A2	NC	No Connection.
A3	PD	Power-Down. Asynchronous power-down signal.
B1	AGND	Analog Ground Pin.
B2	DGND	Digital Ground Pin.
B3	SDA	I ² C Interface Signal.
C1	DGND	Digital Ground Pin.
C2	V _{DD}	Digital Supply Voltage.
C3	SCL	I ² C Interface Signal.

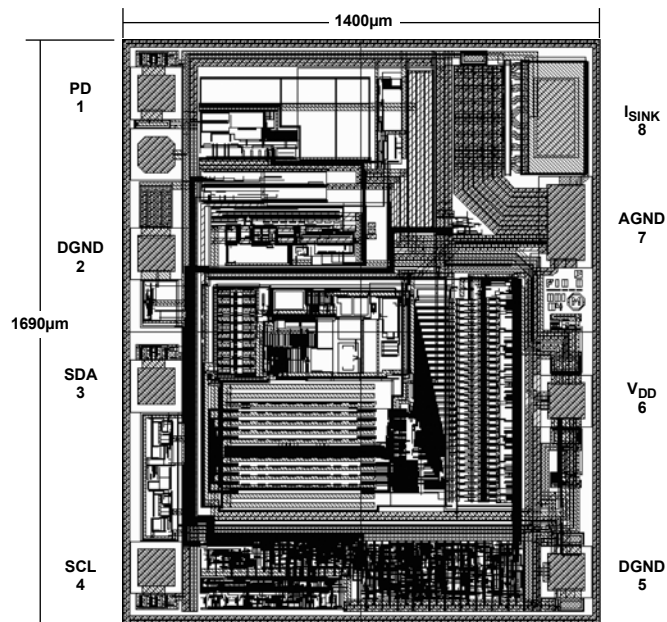

Figure 4. Metallization Photograph
Dimensions shown in µm
Contact Factory for Latest Dimensions

TYPICAL PERFORMANCE CHARACTERISTICS

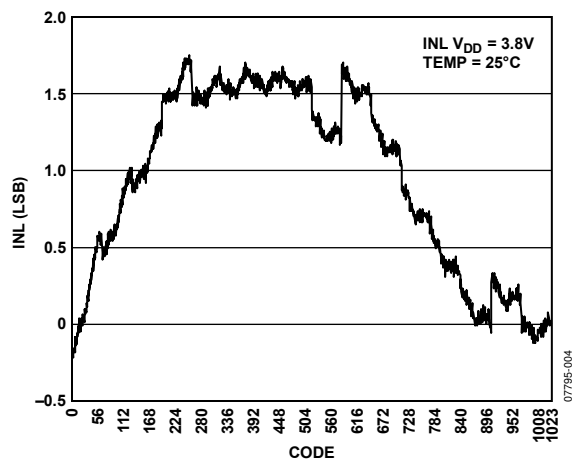

Figure 5. Typical INL vs. Code Plot

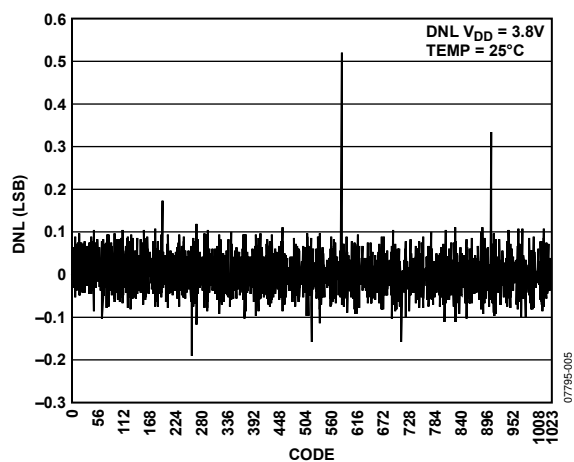

Figure 6. Typical DNL vs. Code Plot

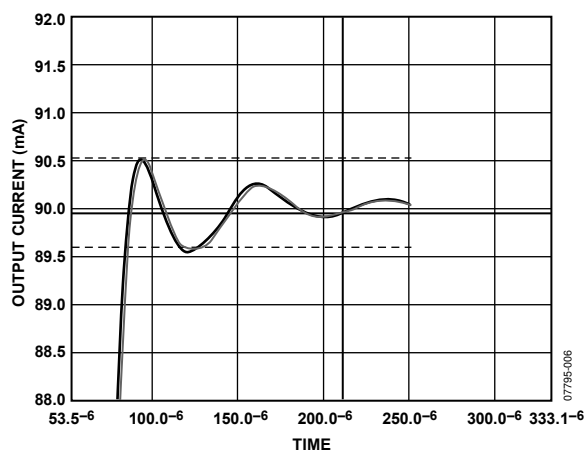

Figure 7. 1/4 to 3/4 Scale Settling Time ($V_{DD} = 3.6 V$)

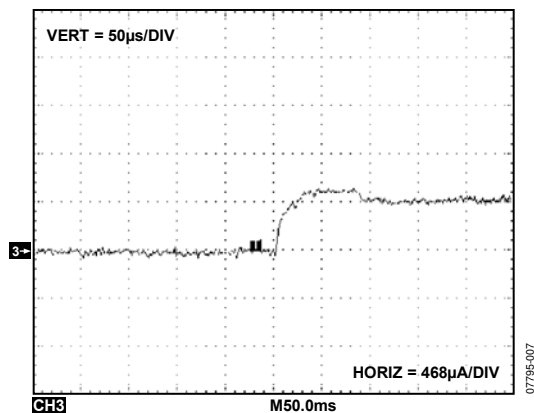

Figure 8. Settling Time for a 4-LSB Step ($V_{DD} = 3.6 V$)

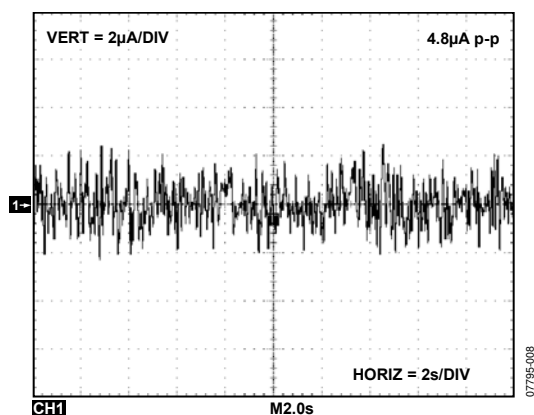

Figure 9. 0.1 Hz to 10 Hz Noise Plot ($V_{DD} = 3.6 V$)

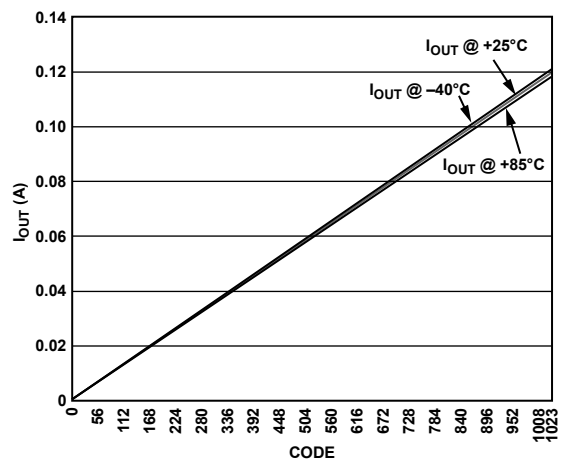

Figure 10. Sink Current vs. Code vs. Temperature ($V_{DD} = 3.6 V$)

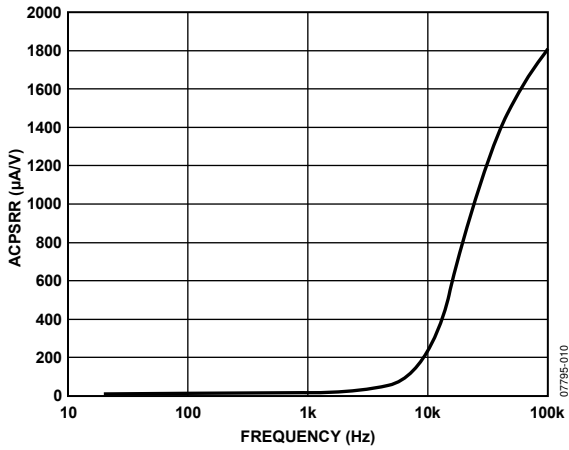

Figure 11. AC Power Supply Rejection Ratio ($V_{DD} = 3.6V$)

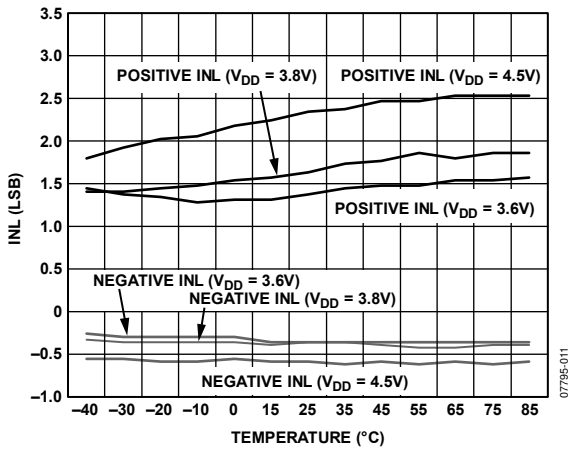

Figure 12. INL vs. Temperature vs. Supply Voltage

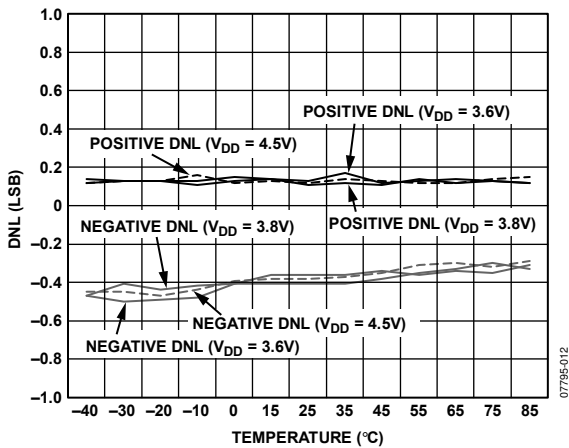

Figure 13. DNL vs. Temperature vs. Supply Voltage

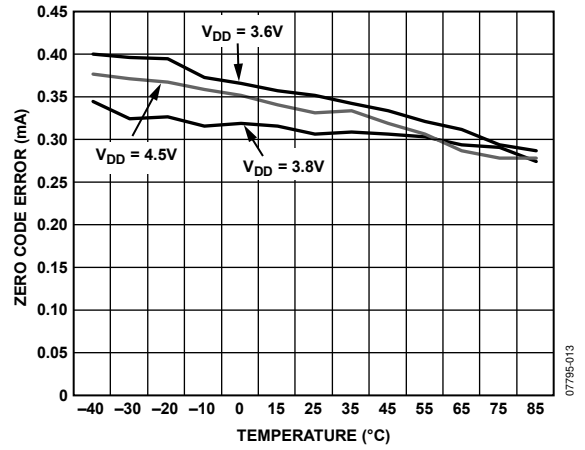

Figure 14. Zero Code Error vs. Temperature vs. Supply Voltage

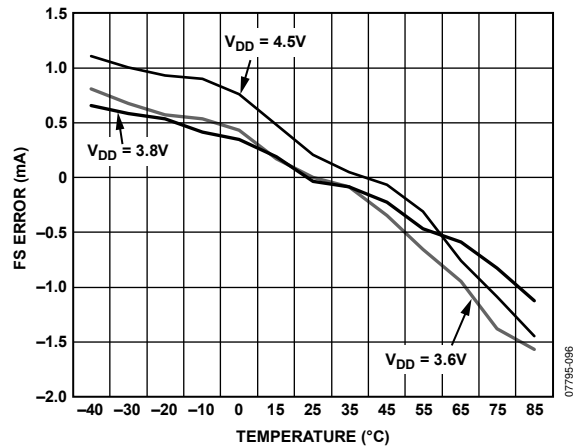

Figure 15. Full-Scale Error vs. Temperature vs. Supply Voltage

TERMINOLOGY

Relative Accuracy

For the DAC, relative accuracy or integral nonlinearity is a measurement of the maximum deviation, in LSB, from a straight line passing through the endpoints of the DAC transfer function. A typical INL vs. code plot is shown in Figure 5.

Differential Nonlinearity (DNL)

Differential nonlinearity is the difference between the measured change and the ideal 1 LSB change between any two adjacent codes. A specified differential nonlinearity of ± 1 LSB maximum ensures monotonicity. This DAC is guaranteed monotonic by design. A typical DNL vs. code plot is shown in Figure 6.

Zero-Code Error

Zero-code error is a measurement of the output error when zero code (0x0000) is loaded to the DAC register. Ideally, the output is 0 mA. The zero-code error is always positive in the AD5398A because the output of the DAC cannot go below 0 mA. This is due to a combination of the offset errors in the DAC and output amplifier. Zero-code error is expressed in mA.

Gain Error

This is a measurement of the span error of the DAC. It is the deviation in slope of the DAC transfer characteristic from the ideal, expressed as a percent of the full-scale range.

Gain Error Drift

This is a measurement of the change in gain error with changes in temperature. It is expressed in LSB/°C.

Digital-to-Analog Glitch Impulse

Digital-to-analog glitch impulse is the impulse injected into the analog output when the input code in the DAC register changes state. It is normally specified as the area of the glitch in nA-sec and is measured when the digital input code is changed by 1 LSB at the major carry transition.

Digital Feedthrough

Digital feedthrough is a measurement of the impulse injected into the analog output of the DAC from the digital inputs of the DAC, however is measured when the DAC output is not updated. It is specified in nA-sec and measured with a full-scale code change on the data bus, that is, from all 0s to all 1s and vice versa.

Offset Error

Offset error is a measurement of the difference between I_{SINK} (actual) and I_{OUT} (ideal) in the linear region of the transfer function, expressed in mA. Offset error is measured on the AD5398A with Code 16 loaded into the DAC register.

Offset Error Drift

This is a measurement of the change in offset error with a change in temperature. It is expressed in $\mu\text{V}/^\circ\text{C}$.

THEORY OF OPERATION

The AD5398A is a fully integrated 10-bit DAC with 120 mA output current sink capability and is intended for driving voice coil actuators in applications such as lens autofocus, image stabilization, and optical zoom. The circuit diagram is shown in Figure 16. A 10-bit current output DAC coupled with Resistor R generates the voltage that drives the noninverting input of the operational amplifier. This voltage also appears across the R_{SENSE} resistor and generates the sink current required to drive the voice coil.

The R and R_{SENSE} resistors are interleaved and matched. Therefore, the temperature coefficient and any nonlinearities over temperature are matched and the output drift over temperature is minimized. Diode D1 is an output protection diode.

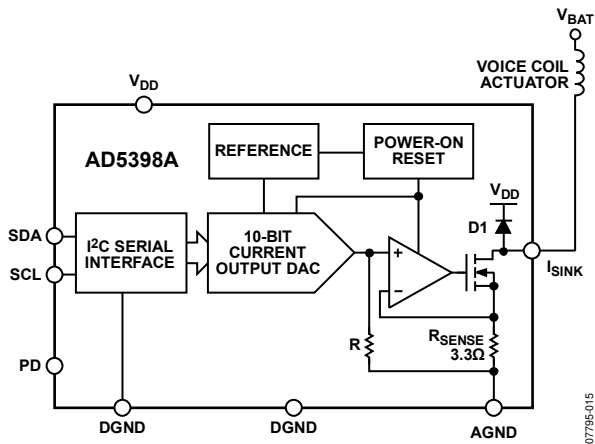

Figure 16. Circuit Diagram Showing Connection to Voice Coil

SERIAL INTERFACE

The AD5398A is controlled using the industry-standard I²C 2-wire serial protocol. Data can be written to or read from the DAC at data rates up to 400 kHz. After a read operation, the contents of the input register are reset to all zeros.

I²C BUS OPERATION

An I²C bus operates with one or more master devices that generate the serial clock (SCL), and read/write data on the serial data line (SDA) to/from slave devices such as the AD5398A. On all devices on an I²C bus, the SCL pin is connected to the SCL line and the SDA pin is connected to the SDA line. I²C devices can only pull the bus lines low; pulling high is achieved by the pull-up resistors, R_P . The value of R_P depends on the data rate, bus capacitance, and the maximum load current that the I²C device can sink (3 mA for a standard device).

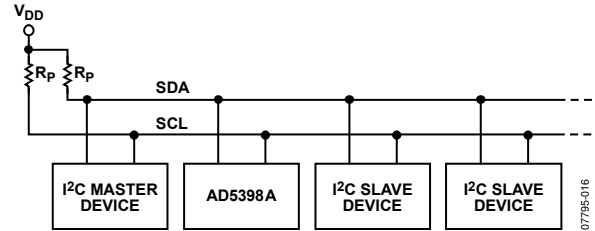

Figure 17. Typical I²C Bus

When the bus is idle, SCL and SDA are both high. The master device initiates a serial bus operation by generating a start condition, which is defined as a high-to-low transition on the SDA line while SCL is high. The slave device connected to the bus responds to the start condition and shifts in the next eight data bits under the control of the serial clock. These eight data bits consist of a 7-bit address, plus a read/write bit, which is 0 if data is to be written to a device, and 1 if data is to be read from a device. Each slave device on an I²C bus must have a unique address. The address of the AD5398A is 0001100; however, 0001101, 0001110, and 0001111 address the part because the last two bits are unused/don't care (see Figure 18 and Figure 19). Because the address plus R/\overline{W} bit always equals eight bits of data, another way of looking at it is that the write address of the AD5398A is 0001 1000 (0x18) and the read address is 0001 1001 (0x19). Again, Bit 6 and Bit 7 of the address are unused, and, therefore, the write addresses can also be 0x1A, 0x1C, and 0x1E, and the read address can be 0x1B, 0x1D, and 0x1F (see Figure 18 and Figure 19).

At the end of the address data, after the R/\overline{W} bit, the slave device that recognizes its own address responds by generating an acknowledge (ACK) condition. This is defined as the slave device pulling SDA low while SCL is low before the ninth clock pulse, and keeping it low during the ninth clock pulse. Upon receiving an ACK, the master device can clock data into the AD5398A in a write operation, or it can clock it out in a read operation. Data must change either during the low period of the clock, because SDA transitions during the high period define a start condition as described previously, or during a stop condition as described in the Data Format section.

I²C data is divided into blocks of eight bits, and the slave generates an ACK at the end of each block. The AD5398A requires 10 bits of data; two data-words must be written to it when a write operation occurs, or read from it when a read operation occurs. At the end of a read or write operation, the AD5398A acknowledges the second data byte. The master generates a stop condition, defined as a low-to-high transition on SDA while SCL is high, to end the transaction.

DATA FORMAT

Data is written to the AD5398A high byte first, MSB first, and is shifted into the 16-bit input register. After all data is shifted in, data from the input register is transferred to the DAC register.

Because the DAC requires only 10 bits of data, not all bits of the input register data are used. The MSB is reserved for an active-high, software-controlled, power-down function.

The data format is shown in Table 6. When referring to this table, note that Bit 14 is unused; Bit 13 to Bit 4 correspond to the DAC data bits, D9 to D0; and Bit 3 to Bit 0 are unused.

During a read operation, data is read in the same bit order.

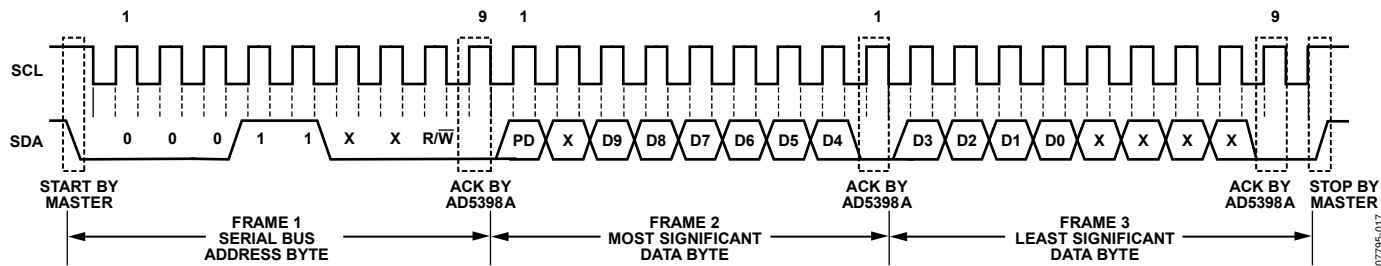

Figure 18. Write Operation

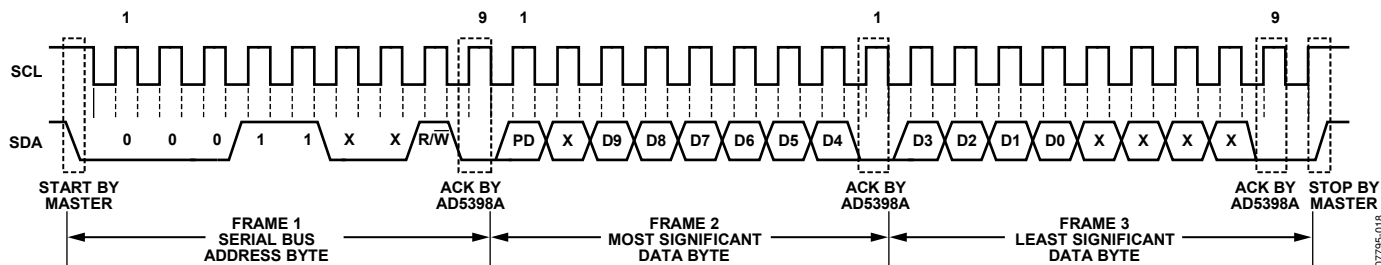

Figure 19. Read Operation

Table 6. Data Format

Serial Data- Words	High Byte								Low Byte							
	Bit 15	Bit 14	Bit 13	Bit 12	Bit 11	Bit 10	Bit 9	Bit 8	Bit 7	Bit 6	Bit 5	Bit 4	Bit 3	Bit 2	Bit 1	Bit 0
Serial Data Bits	SD7	SD6	SD5	SD4	SD3	SD2	SD1	SD0	SD7	SD6	SD5	SD4	SD3	SD2	SD1	SD0
Input Register	R15	R14	R13	R12	R11	R10	R9	R8	R7	R6	R5	R4	R3	R2	R1	R0
Function ¹	PD	X	D9	D8	D7	D6	D5	D4	D3	D2	D1	D0	X	X	X	X

¹ PD = soft power-down; X = unused/don't care; and D7 to D0 = DAC data.

OUTLINE DIMENSIONS

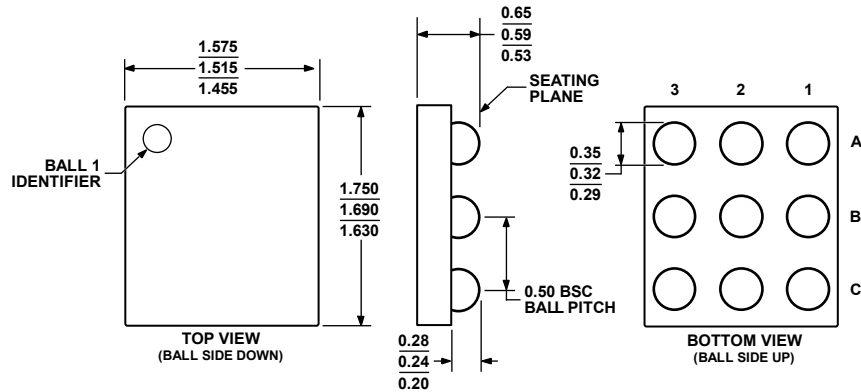

081306-B

Figure 23. 9-Ball Wafer Level Chip Scale Package [WLCSP]
(CB-9-1)
Dimensions shown in millimeters

ORDERING GUIDE

Model	Temperature Range	Package Description	Package Option	Branding
AD5398ABCZ-REEL ¹	-30°C to +85°C	9-Ball Wafer Level Chip Scale (WLCSP)	CB-9-1	1Z
AD5398ABCZ-REEL ¹	-30°C to +85°C	9-Ball Wafer Level Chip Scale (WLCSP)	CB-9-1	1Z
AD5398A-WAFER	-40°C to +85°C	Bare Die Wafer		
EVAL-AD5398AEBZ ¹		Evaluation Board		

¹ Z = RoHS Compliant Part.

NOTES

AD5398A

NOTES

Purchase of licensed I²C components of Analog Devices or one of its sublicensed Associated Companies conveys a license for the purchaser under the Philips I²C Patent Rights to use these components in an I²C system, provided that the system conforms to the I²C Standard Specification as defined by Philips.

©2008 Analog Devices, Inc. All rights reserved. Trademarks and registered trademarks are the property of their respective owners.
D07795-0-10/08(0)



www.analog.com