

User Manual

ASR-3100 Series

1U Rackmount dual Xeon E5-2600 v3 NVMe Storage Server, supporting SFF-8639 2.5" NVMe SSD and 2 x PCIe Gen III x8 slot

ADVANTECH

Enabling an Intelligent Planet

Copyright

The documentation and the software included with this product are copyrighted 2014 by Advantech Co., Ltd. All rights are reserved. Advantech Co., Ltd. reserves the right to make improvements in the products described in this manual at any time without notice. No part of this manual may be reproduced, copied, translated or transmitted in any form or by any means without the prior written permission of Advantech Co., Ltd. Information provided in this manual is intended to be accurate and reliable. However, Advantech Co., Ltd. assumes no responsibility for its use, nor for any infringements of the rights of third parties, which may result from its use.

Acknowledgements

Intel and Pentium are trademarks of Intel Corporation.

Microsoft Windows and MS-DOS are registered trademarks of Microsoft Corp.

All other product names or trademarks are properties of their respective owners.

Product Warranty (2 years)

Advantech warrants to you, the original purchaser, that each of its products will be free from defects in materials and workmanship for two years from the date of purchase.

This warranty does not apply to any products which have been repaired or altered by persons other than repair personnel authorized by Advantech, or which have been subject to misuse, abuse, accident or improper installation. Advantech assumes no liability under the terms of this warranty as a consequence of such events.

Because of Advantech's high quality-control standards and rigorous testing, most of our customers never need to use our repair service. If an Advantech product is defective, it will be repaired or replaced at no charge during the warranty period. For out-of-warranty repairs, you will be billed according to the cost of replacement materials, service time and freight. Please consult your dealer for more details.

If you think you have a defective product, follow these steps:

1. Collect all the information about the problem encountered. (For example, CPU speed, Advantech products used, other hardware and software used, etc.) Note anything abnormal and list any onscreen messages you get when the problem occurs.
2. Call your dealer and describe the problem. Please have your manual, product, and any helpful information readily available.
3. If your product is diagnosed as defective, obtain an RMA (return merchandise authorization) number from your dealer. This allows us to process your return more quickly.
4. Carefully pack the defective product, a fully-completed Repair and Replacement Order Card and a photocopy proof of purchase date (such as your sales receipt) in a shippable container. A product returned without proof of the purchase date is not eligible for warranty service.
5. Write the RMA number visibly on the outside of the package and ship it prepaid to your dealer.

A Message to the Customer

Advantech Customer Services

Each and every Advantech product is built to the most exacting specifications to ensure reliable performance in the harsh and demanding conditions typical of industrial environments. Whether your new Advantech equipment is destined for the laboratory or the factory floor, you can be assured that your product will provide the reliability and ease of operation for which the name Advantech has come to be known.

Your satisfaction is our primary concern. Here is a guide to Advantech's customer services. To ensure you get the full benefit of our services, please follow the instructions below carefully.

Technical Support

We want you to get the maximum performance from your products. So if you run into technical difficulties, we are here to help. For the most frequently asked questions, you can easily find answers in your product documentation. These answers are normally a lot more detailed than the ones we can give over the phone.

So please consult this manual first. If you still cannot find the answer, gather all the information or questions that apply to your problem, and with the product close at hand, call your dealer. Our dealers are well trained and ready to give you the support you need to get the most from your Advantech products. In fact, most problems reported are minor and are easily solved over the phone.

In addition, free technical support is available from Advantech engineers every business day. We are always ready to give advice on application requirements or specific information on the installation and operation of any of our products.

Declaration of Conformity

FCC Class A

Note: This equipment has been tested and found to comply with the limits for a Class A digital device, pursuant to part 15 of the FCC Rules. These limits are designed to provide reasonable protection against harmful interference when the equipment is operated in a commercial environment. This equipment generates, uses, and can radiate radio frequency energy and, if not installed and used in accordance with the instruction manual, may cause harmful interference to radio communications. Operation of this equipment in a residential area is likely to cause harmful interference in which case the user will be required to correct the interference at his own expense.

Safety Information

Retain and follow all product safety and operating instructions provided with your equipment. In the event of a conflict between the instructions in this guide and the instructions in equipment documentation, follow the guidelines in the equipment documentation.

Observe all warnings on the product and in the operating instructions. To reduce the risk of bodily injury, electric shock, fire and damage to the equipment, observe all precautions included in this guide.

You must become familiar with the safety information in this guide before you install, operate, or service Advantech products.

Machine Room Environment

- Make sure that the area in which you install the system is properly ventilated and climate-controlled.
- Ensure that the voltage and frequency of your power source match the voltage and frequency inscribed on the electrical rating label of the equipment.
- Do not install the system in or near a plenum, air duct, radiator, or heat register.
- Never use the product in a wet location.

Equipment Chassis

- Do not block or cover the openings to the system.
- Never push objects of any kind through openings in the equipment.
- Dangerous voltages might be present.
- Conductive foreign objects can produce a short circuit and cause fire, electric shock, or damage to your equipment.
- Lift equipment using both hands and with your knees bent.

Rack Mount Instructions

The following or similar rack-mount instructions are included with the installation instructions:

- Elevated Operating Ambient - If installed in a closed or multi-unit rack assembly, the operating ambient temperature of the rack environment may be greater than room ambient. Therefore, consideration should be given to installing the equipment in an environment compatible with the maximum ambient temperature (T_{ma}) specified by the manufacturer.
- Reduced Air Flow - Installation of the equipment in a rack should be such that the amount of air flow required for safe operation of the equipment is not compromised.
- Mechanical Loading - Mounting of the equipment in the rack should be such that a hazardous condition is not achieved due to uneven mechanical loading.
- Circuit Overloading - Consideration should be given to the connection of the equipment to the supply circuit and the effect that overloading of the circuits might have on overcurrent protection and supply wiring.
- Appropriate consideration of equipment nameplate ratings should be used when addressing this concern.
- Reliable Earthing - Reliable earthing of rackmounted equipment should be maintained. Particular attention should be given to supply connections other than direct connections to the branch circuit (e.g. use of power strips).

- Make sure only one component is extended at a time. A rack might become unstable if more than one component is extended.

Equipment Batteries*

- The system battery contains lithium manganese dioxide. If the battery pack is not handled properly, there is risk of fire and burns.
- Do not disassemble, crush, puncture, short external contacts, or dispose of the battery in fire or water.
- Do not expose the battery to temperatures higher than 60°C (140°F).
- The system battery is not replaceable. If the battery is replaced by an incorrect type, there is danger of explosion. Replace the battery only with a spare designated for your product.
- Do not attempt to recharge the battery.
- Dispose of used batteries according to the instructions of the manufacturer.
- Do not dispose of batteries with the general household waste. To forward them to recycling or proper disposal, use the public collection system or return them to Advantech, your authorized Advantech partner, or their agents.

Equipment Modifications

- Do not make mechanical modifications to the system. Advantech is not responsible for the regulatory compliance of Advantech equipment that has been modified.

Equipment Repairs and Servicing

- The installation of internal options and routine maintenance and service of this product should be performed by individuals who are knowledgeable about the procedures, precautions, and hazards associated with equipment containing hazardous energy levels.
- Do not exceed the level of repair specified in the procedures in the product documentation. Improper repairs can create a safety hazard.
- Allow the product to cool before removing covers and touching internal components.
- Remove all watches, rings, or loose jewelry when working before removing covers and touching internal components.
- Do not use conductive tools that could bridge live parts.
- Use gloves when you remove or replace system components; they can become hot to the touch.
 - If the product sustains damage requiring service, disconnect the product from the AC electrical outlet and refer servicing to an authorized service provider. Examples of damage requiring service include:
 - The power cord, extension cord, or plug has been damaged.
 - Liquid has been spilled on the product or an object has fallen into the product.
 - The product has been exposed to rain or water.
 - The product has been dropped or damaged.
 - The product does not operate normally when you follow the operating instructions.

Note! *Danger of explosion if battery is incorrectly replaced.*



Replace only with the same or equivalent type recommended by the manufacture. Discard used batteries according to the manufacture's instructions.

Danger d'explosion si la batterie est remplacée de façon incorrecte.

Remplacez-la uniquement avec le même type ou équivalent recommandé par la fabrication. Jetez les piles usagées selon les instructions du fabricant.

Peripheral Compatibility

Category	Advantech PN	Vendor	Part Description	Remarks
CPU	96MPXE-2.2-30M20T	Intel	Xeon E5-2658 v3/2.2GHz/12cores	95W
	96MPXE-2.4-15M20T	Intel	Xeon E5-2620 v3/2.4GHz/6cores	95W
	96MPXE-1.9-15M20T	Intel	Xeon E5-2609 v3/1.9GHz/6cores	80W
	96MPXE-2.6-20M20T	Intel	Xeon E5-2640 v3/2.6GHz/8cores	95W
	96MPXE-2.5-30M20T	Intel	Xeon E5-2680 v3/2.5GHz/12cores	115W
	TBD	Intel	Xeon E5-2698 v3/2.3GHz/16cores	135W
	TBD	Intel	Xeon E5-2695 v3/2.3GHz/14cores	120W
	TBD	Intel	Xeon E5-2690 v3/2.6GHz/12cores	135W
	TBD	Intel	Xeon E5-2683 v3/2.0GHz/14cores	120W
	TBD	Intel	Xeon E5-2680 v3/2.5GHz/12cores	120W
	TBD	Intel	Xeon E5-2670 v3/2.3GHz/12cores	120W
	TBD	Intel	Xeon E5-2667 v3/3.2GHz/8cores	135W
	TBD	Intel	Xeon E5-2660 v3/2.6GHz/10cores	105W
	TBD	Intel	Xeon E5-2658A v3/2.2GHz/12cores	105W
	TBD	Intel	Xeon E5-2658 v3/2.2GHz/12cores	105W
	TBD	Intel	Xeon E5-2650L v3/1.8GHz/12cores	65W
	TBD	Intel	Xeon E5-2650 v3/2.3GHz/10cores	105W
	TBD	Intel	Xeon E5-2648L v3/1.8GHz/12cores	75W
	TBD	Intel	Xeon E5-2643 v3/3.4GHz/6cores	135W
	TBD	Intel	Xeon E5-2640 v3/2.6GHz/8cores	90W
	TBD	Intel	Xeon E5-2637 v3/3.5GHz/4cores	135W
	TBD	Intel	Xeon E5-2630L v3/1.8GHz/8cores	55W
	TBD	Intel	Xeon E5-2630 v3/2.4GHz/8cores	85W
	TBD	Intel	Xeon E5-2628L v3/2.0GHz/10cores	75W
	TBD	Intel	Xeon E5-2623 v3/3.0GHz/4cores	105W
	TBD	Intel	Xeon E5-2620 v3/2.4GHz/6cores	85W
	TBD	Intel	Xeon E5-2618L v3/2.3GHz/8cores	75W
	TBD	Intel	Xeon E5-2609 v3/1.9GHz/6cores	85W
	TBD	Intel	Xeon E5-2608L v3/2.0GHz/6cores	52W
	TBD	Intel	Xeon E5-2603 v3/1.6GHz/6cores	85W
Memory	TBD	TBD	DDR4 288PIN ECC-REG DIMM, capacity up to 32GB per module	-

Note! ASR-3100 system *MUST* use the SSD or enterprise level SATA HDD or SAS HDD.



Initial Inspection

Before powering up the system, please make sure that the following materials have been shipped:

- 1 x ASR-3100 system
- 1 x ASR-3100 Startup Manual
- 1 x Driver CD (User Manual is included)
- 2 x CPU heatsink
- 1 x Slide rail kit
- 1 x CMA (Cable Management Arm)
- 2 x Mounting ears with handle

If any of these items are missing or damaged, contact distributor or sales representative immediately. We have carefully inspected the ASR-3100 mechanically and electrically before shipment. It should be free of marks and scratches and in perfect working order upon receipt. When unpacking the ASR-3100, check it for signs of shipping damage. (For example, damaged box, scratches, dents, etc.) If it is damaged or it fails to meet the specifications, notify our service department or local sales representative immediately. Also notify the carrier. Retain the shipping carton and packing material for inspection by the carrier. After inspection, we will make arrangements to repair or replace the unit.

Order Information

Part number	2.5" Front HDD	2nd Row 2.5" HDD	PCIe Slot	Chassis Depth
ASR-3100PP-R11A1E	x8 NVMe (SAS is optional)	x8 NVMe + SATA	2	806 mm
ASR-3100PT-R11A1E	x8 NVMe (SAS is optional)	x8 SATA	2	806 mm
ASR-3100SS-R11A1E	x8 SAS+SATA (x2 NVMe is optional)	x8 SAS+SATA	2	806 mm

Contents

Chapter 1	Overview	1
1.1	Introduction	2
1.2	Features	2
1.3	System Specifications	3
1.4	System Layout, LED, Jumpers and Connectors	5
1.4.1	LED Definitions	6
1.4.2	Jumpers	7
1.4.3	Connectors.....	7
1.5	Block Diagram.....	8
1.6	System Memory	8
1.7	Memory Installation Procedures.....	9
Chapter 2	Setting up	11
2.1	Before you Begin.....	12
2.1.1	Work Area	12
2.1.2	Tools	12
2.1.3	Precautions	12
2.2	Installing Motherboard Components	13
2.2.1	Removing the Chassis Cover	13
2.2.2	Installing the CPU and Heatsink	13
2.2.3	Installing the Memory.....	17
2.2.4	Installing Hard Drives.....	18
2.2.5	Installing PCIe x8 Expansion Card	20
2.3	Rack Mounting	22
2.3.1	Installing the Server in a Rack	22
Chapter 3	AMI BIOS	27
3.1	Introduction	28
3.2	BIOS Setup	29
3.2.1	Main Menu	29
3.2.2	Advanced BIOS Features Setup.....	30
3.2.3	Intel RC Setup.....	40
3.2.4	Server Management	56
3.2.5	Security	60
3.2.6	Boot.....	60
3.2.7	Save & Exit	61
Chapter 4	Chipset Software Installation Utility	63
4.1	Before You Begin	64
4.2	Introduction	64
4.2.1	Main Menu	64
4.3	Windows OS Driver Setup	65
Chapter 5	VGA Setup	67
5.1	Introduction	68
5.2	Windows Series Driver Setup	68

Chapter 6 LAN Configuration / SATA RAID & AHCI / USB 3.0 Setup

6.1	LAN Configuration.....	70
6.1.1	Introduction	70
6.1.2	Features.....	70
6.1.3	Installation.....	70
6.1.4	Windows Series Driver Setup (LAN).....	70
6.2	AHCI & SATA RAID	71
6.3	USB3.0.....	72

Appendix A Programming the Watchdog Timer . 73

A.1	Watchdog Timer Overview.....	74
A.2	Programming the Watchdog Timer	74

Chapter 1

Overview

1.1 Introduction

ASR-3100, the world's first 1U rackmount dual Intel® Xeon® E5-2600 16 x NVMe SSD Storage Server. ASR-3100 is a 1U rackmount dual Intel® Xeon® E5-2600 v3 storage server, equipped with DDR4-2133 RDIMM up to 512GB and maximum 16 x 2.5" hot-plug NVMe SSD, delivering uncompromised high computing performance. The incredible high IOPS (Input/Output Operations Per Second) performance of 16 NVMe SSD can achieve up to 6 million IOPS read speeds, which is at least 30% better than existing products on the market. ASR-3100 is designed to fulfill markets like cache/hot data, VDI (Virtual Desktop Infrastructure), advanced data mining, OLTP (Online Transaction Processing)/ OLAP (Online Analytical Processing) for finance and eCommerce, 3D rendering, video broadcasting and massive media editing/ post production.

1.2 Features

- 1U rackmount with dual Intel® Xeon® E5-2600 v3 processor, DDR4-2133 RDIMM up to 512 GB
- Up to 6 million IOPS read speeds with 16 x 2.5" hot-plug NVMe SSD, which is 30% better than existing products on the market
- SFF-8639 designed for enterprise use – supports 2.5" PCIe, SAS, SATA
- Optimized system power, performance and cooling efficiency with a 1100W 1+1 redundant power supply of 80 PLUS Platinum level
- Expandable with 2 *PCIe x8 Gen 3 cards (One is FHHL and the other is HHHL) and embedded M.2 SATA 6G for OS mirror
- Easy management with IPMI LSI Raid management, multiple system LED indicator, and front and rear I/O

Note! Please refer to the release note of each Linux OS for Intel's C612 chipset SATA RAID function support.



1.3 System Specifications

Processor	
CPU	<ul style="list-style-type: none"> ■ Dual Intel LGA2011-R3 Xeon processor sockets ■ Supports Intel Xeon E5-2600 v3 series processor ■ Supports the processor TDP up to 135 W.
System Memory	
Memory Capacity	<ul style="list-style-type: none"> ■ Intel Xeon processor supports DDR4 memory bus ■ Total 16 288-pin memory slots provided ■ Supports total capacity up to 512 GB ■ 4 channels per processor, 2 memory slot per channel
Memory Type	■ Supports DDR4 1600/1866/2133 MHz ECC Registered Modules
Memory Sizes	Each memory slot supports 4GB, 8GB, 16GB and 32GB memory modules
Memory Voltage	1.2 V
Error Detection	<ul style="list-style-type: none"> ■ Corrects single-bit errors ■ Detects double-bit errors (using ECC memory)
On-board Devices	
Chipsets	Intel C612 PCH provide 8 PCIe x1 Gen2 lanes
Network Controllers	<ul style="list-style-type: none"> ■ 2 x Intel I210 Gigabit Ethernet Controller connected to C612 through PCIe Gen2 Lane ■ Above network Supports 10BASE-T, 100BASE-T, and 1000BASE-T, with RJ-45 output
VGA	ASPEED AST2400 controller with 64 MB VGA memory provides basic 2D VGA function.
Super I/O	Nuvoton NCT6776D chip provide motherboard, RS-232 and hardware monitor functions.
BMC	Sharing with the RJ45 port of LAN2.
Input / Output	
Storage	<ul style="list-style-type: none"> ■ Up to 16 x 2.5" HDD bays to support NVMe/SAS 12G/SATA 6G by different SKUs ■ RAID 0, 1, 5, 10 support (Windows only for Native SATA and NVMe Drives).
LAN	1 x RJ-45 LAN ports (10/100/1000 Base-T LAN).
USB	<ul style="list-style-type: none"> ■ 4 x USB 3.0 ports at rear window. ■ 2 x USB 2.0 ports at front window.
VGA	1 x D-Sub port
Serial Port	1 connector in rear
Power Supply	
Power	80 PLUS Platinum 1+1 redundant power supply 900 W @ 100 ~ 120 V 1100 W @ 200 ~ 240 V
Expansion Slots	
PCI-express	<ul style="list-style-type: none"> ■ 2 x PCI-E x8 slot (Gen3 x8 link) <ul style="list-style-type: none"> – PCIEX8_SLOT2 on the upper from CPU0 and supports FHHL card with full height bracket – PCIEX8_SLOT1 on the bottom from CPU1 and support HHL card with full height bracket
System BIOS	

BIOS type	128 Mb SPI Flash EEPROM with AMI BIOS
PC Health Monitoring	
Voltage	Monitors for CPU Cores, +3.3 V, +5 V, +12 V, +5 V Standby, VBAT
Fan	<ul style="list-style-type: none"> ■ Seven 4-pin 40x56 fan for CPU cooling. ■ All fans with tachometer status monitoring
Temperature	<ul style="list-style-type: none"> Monitoring for CPU0 & CPU1 (PECI) Monitoring for System (HWM)
Other Features (Case Open)	<ul style="list-style-type: none"> ■ Chassis intrusion detection ■ Chassis Intrusion header
Operating Environment / Compliance	
RoHS	RoHS Compliant 6/6 Pb Free
Environmental Spec.	<ul style="list-style-type: none"> ■ Operating Temperature: 0 to 40° C ■ Non-operating Temperature: -20 to 60° C ■ Operating Relative Humidity: 10% to 85% @ 40° C (non-condensing) ■ Non-operating Relative Humidity: 10% to 95% (non-condensing)

1.4 System Layout, LED, Jumpers and Connectors

Connectors on the ASR-3100 are linked to external devices such as 10/100/1000 Ethernet, VGA monitor, and Com port. In addition, ASR-3100 has jumpers that are used to clean CMOS for BIOS.

The tables below list the functions of each jumper and connector. Later sections in this chapter give instructions for setting jumpers. Chapter 2 gives instructions for connecting external devices to ASR-3100.

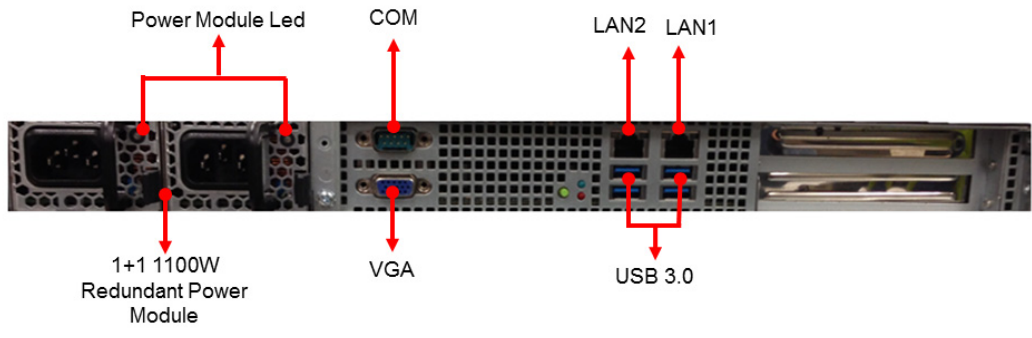
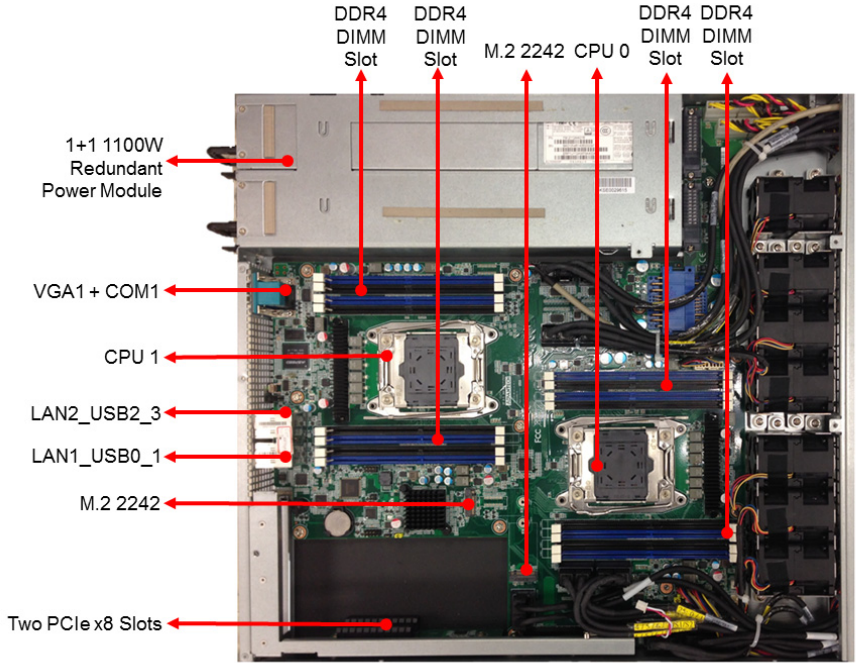

1.4.1 LED Definitions

Front I/O LED

LED	State	Color	Description
Power LED	On	Green	System is turned on
	Blinking	Green	System is under S1 or S4 state
	Off	Off	Power off
LAN1/LAN2 LED	Blinking	Green	LAN active
	On	Green	LAN linked
	Off	Off	LAN unlinked
Error LED	On	Red	Fan fail; Over-voltage
	Off	Off	No failure
Location LED	On	Blue	System identified
	Off	Off	System unidentified

HDD LED

HDD status	Status LED Color: Amber	Activity LED Color: Green
No driver present or power disconnected	Off	Off
Driver present	No activity	On
	Access activity	Blinking
HDD fail	On	Off (only work under the RAID mode)
Identify (locate the HDD)	4HZ	Off (only work under the RAID mode)
SATA/SAS RAID building	1 HZ	Off (only work under the RAID mode)

Rear I/O LED (1)

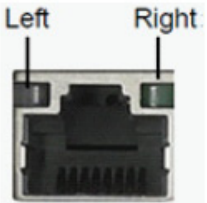
LED	Left LED	Right LED	Description
	Off	Green	10 Mbps linked
	Off	Blinking Green	10 Mbps Active
	Amber	Green	100 Mbps linked
	Amber	Blinking Green	100 Mbps Active
	Green	Green	1000 Mbps linked
	Green	Blinking Green	1000 Mbps Active
LAN1 ~ LAN2 LED	Off	Off	No Link

Rear I/O LED(2)

Error LED	On	Red	Fan fail; Over voltage
	Off	Off	No failure
Location LED	On	Blue	System identified
	Off	Off	System unidentified

Power module LED	Blinking	Red	No AC power to this module
	Blinking	Blue	AC present standby output on
	On	Red	Power supply failure
	On	Blue	Power supply DC output ON and OK
	Off	Off	No AC power to power module

1.4.2 Jumpers

Label	Function	Default
JCMOS1	CMOS clear	1-2
JME1	ME update	1-2

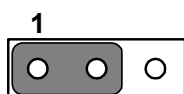

Keep CMOS data / Disable ME update

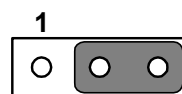

Clear CMOS data / Enable ME update

1.4.3 Connectors

CPU0	Intel LGA2011-R3 CPU0 socket
CPU1	Intel LGA2011-R3 CPU1 socket
SYSFAN1 ~ SYSFAN3/ SYSFAN5 ~ SYSFAN8	System fan connector (4-pin)
DIMMA1	Channel A DIMM1 of CPU0
DIMMA2	Channel A DIMM2 of CPU0
DIMMB1	Channel B DIMM1 of CPU0
DIMMB2	Channel B DIMM2 of CPU0
DIMMC1	Channel C DIMM1 of CPU0
DIMMC2	Channel C DIMM2 of CPU0
DIMMD1	Channel D DIMM1 of CPU0
DIMMD2	Channel D DIMM2 of CPU0
DIMME1	Channel E DIMM1 of CPU0
DIMME2	Channel E DIMM2 of CPU0
DIMMF1	Channel F DIMM1 of CPU0
DIMMF2	Channel F DIMM2 of CPU0
DIMMG1	Channel G DIMM1 of CPU0
DIMMG2	Channel G DIMM2 of CPU0
DIMMH1	Channel H DIMM1 of CPU0
DIMMH2	Channel H DIMM2 of CPU0
BMC1	IPMI module connector
SSD0-1	NVMe SSD 0 and SSD 1 connector
SSD2-3	NVMe SSD 2 and SSD 3 connector
SSD4-5	NVMe SSD 4 and SSD 5 connector
SSD6-7	NVMe SSD 6 and SSD 7 connector
SSD8-9	NVMe SSD 8 and SSD 9 connector
SSD10-11	NVMe SSD 10 and SSD 11 connector

SSD12-13	NVMe SSD 12 and SSD 13 connector
SSD14-15	NVMe SSD 14 and SSD 15 connector
SATA_CON1	8 ports SATA Drive connector
SATA4	M.2 2242 SATA Drive connector
SATA5	M.2 2242 SATA Drive connector
PCIEX16_SLOT1	PCIe x16 slot for two x8 riser card (Gen3 x 8 link from both CPU0 and CPU1)
LPC1	LPC port for debug
VGA1/COM1	VGA and Com port connector
SMBUS1	SMbus from PCH
USB_4_1	Front Panel one USB 2.0 port
LAN1	10/100/1000 Mbps LAN
LAN2	10/100/1000 Mbps LAN/BMC LAN port
USB0_1	Rear two USB 3.0 port
USB2_3	Rear two USB 3.0 port

1.5 Block Diagram

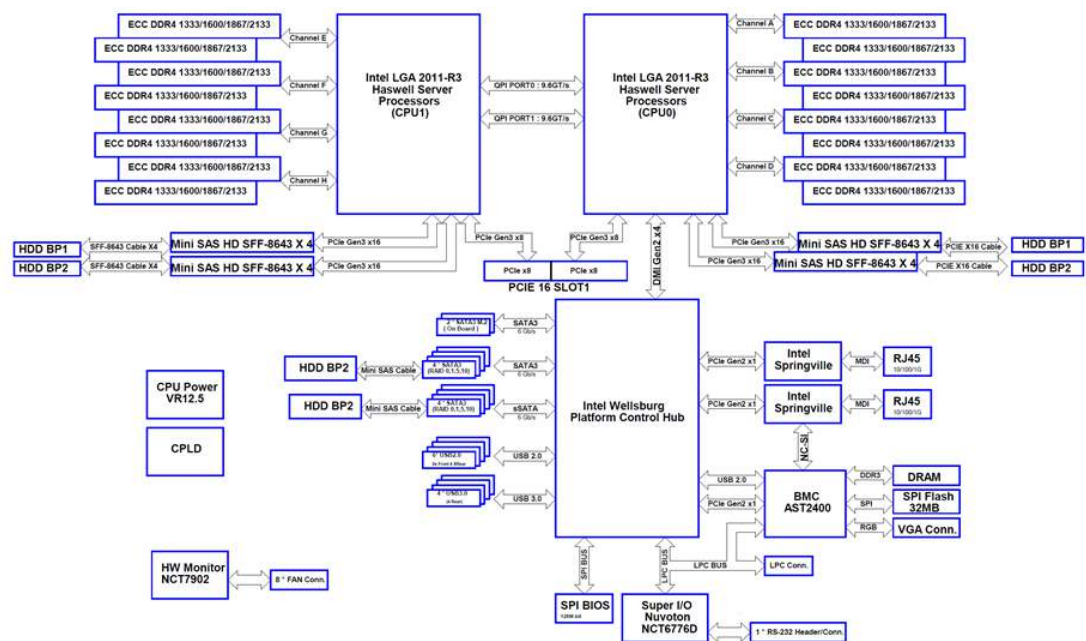

1.6 System Memory

ASR-3100 has 288-pin memory slots x16 for DDR4 1600/1866/2133 MHz memory modules with maximum capacity of 512 GB (Maximum 32 GB for each DIMM). ASR-3100 supports registered DIMMs ONLY.

1.7 Memory Installation Procedures

	Single processor installed (CPU0)								Dual processor installed (CPU0 & CPU1)							
	1	2	3	4	5	6	7	8	1	2	3	4	5	6	7	8
DIMMA1	V	V	V	V	V	V	V	V	V	V	V	V	V	V	V	V
DIMMA2		V	V	V	V	V	V	V		V	V	V	V	V	V	V
DIMMB1			V	V	V	V	V	V			V	V	V	V	V	V
DIMMB2				V	V	V	V	V				V	V	V	V	V
DIMMC1					V	V	V	V					V	V	V	V
DIMMC2						V	V	V						V	V	V
DIMMD1							V	V							V	V
DIMMD2								V								V
DIMME1									V	V	V	V	V	V	V	V
DIMME2										V	V	V	V	V	V	V
DIMMF1											V	V	V	V	V	V
DIMMF2												V	V	V	V	V
DIMMG1													V	V	V	V
DIMMG2														V	V	V
DIMMH1															V	V
DIMMH2																V

Chapter 2

Setting up

2.1 Before you Begin

This chapter explains how to install the CPUs, CPU heatsinks, memory modules, and hard drives. Instructions on inserting add-on cards are also given.

2.1.1 Work Area

Make sure you have a stable, clean working environment. Dust and dirt can get into components and cause malfunctions. Use containers to keep small components separated. Putting all small components in separate containers prevents them from becoming lost. Adequate lighting and proper tools can prevent you from accidentally damaging the internal components.

2.1.2 Tools

The following procedures require only a few tools, including the following:

- A cross head (Phillips) screwdriver
- A grounding strap or an anti-static pad

Most of the electrical and mechanical connections can be disconnected with your hands. It is recommended that you do not use pliers to remove connectors as it may damage the soft metal or plastic parts of the connectors.

2.1.3 Precautions

Components and electronic circuit boards can be damaged by discharges of static electricity. Working on a system that is connected to a power supply can be extremely dangerous. Follow the guidelines below to avoid damage to ASR-3100 or injury to yourself.

- Ground yourself properly before removing the top cover of the system. Unplug the power from the power supply and then touch a safely grounded object to release static charge (i.e. power supply case). If available, wear a grounded wrist strap. Alternatively, discharge any static electricity by touching the bare metal chassis of the unit case, or the bare metal body of any other grounded appliance.
- Avoid touching motherboard components, IC chips, connectors, memory modules, and leads.
- The motherboard is pre-installed in the system. When removing the motherboard, always place it on a grounded anti-static surface until you are ready to reinstall it.
- Hold electronic circuit boards by the edges only. Do not touch the components on the board unless it is necessary to do so. Do not flex or stress circuit boards.
- Leave all components inside the static-proof packaging that they ship with until they are ready for installation.
- After replacing optional devices, make sure all screws, springs, or other small parts are in place and are not left loose inside the case. Metallic parts or metal flakes can cause electrical shorts.

2.2 Installing Motherboard Components

This section describes how to install components on to the mainboard, including CPUs, memory modules and add on cards.

2.2.1 Removing the Chassis Cover

Follow these instructions to remove ASR-3100 chassis cover.

1. Unscrew the top cover as follows.

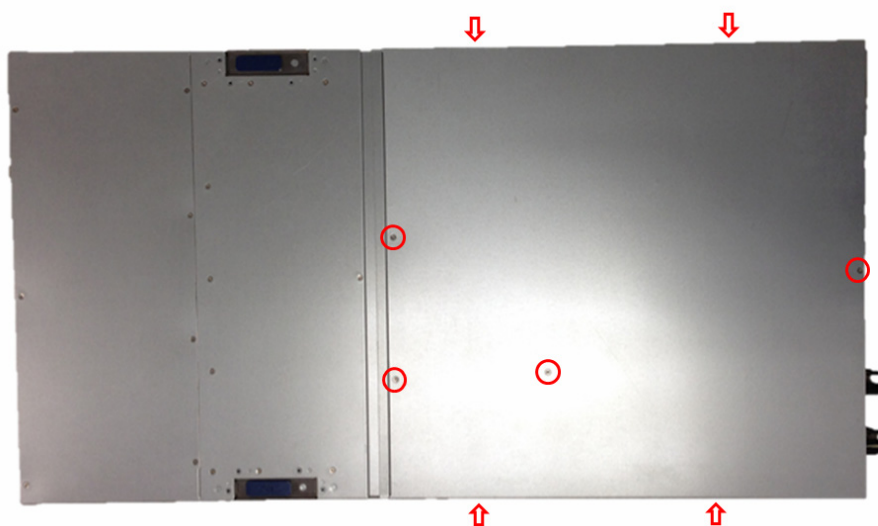

2.2.2 Installing the CPU and Heatsink

Follow the steps below to install CPUs and CPU heatsinks.

1. Locate the CPU sockets - you must install into the CPU0 socket first.

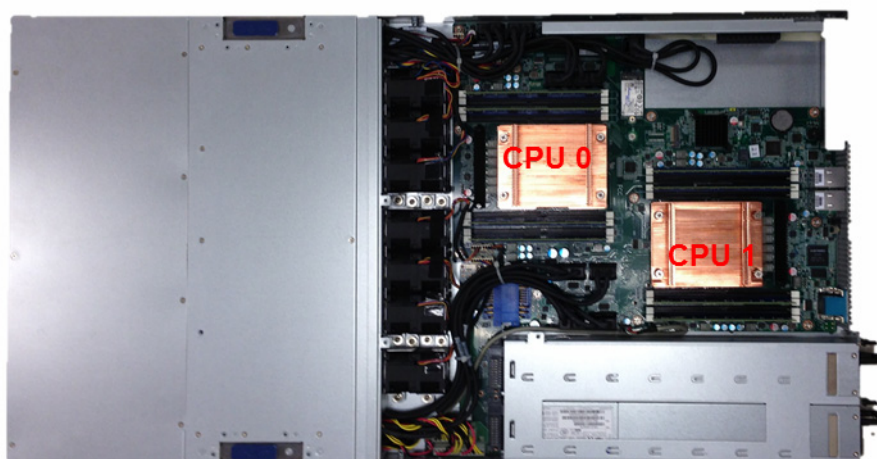

2. Pull the lever slightly away from the socket and then push it to a fully open position.

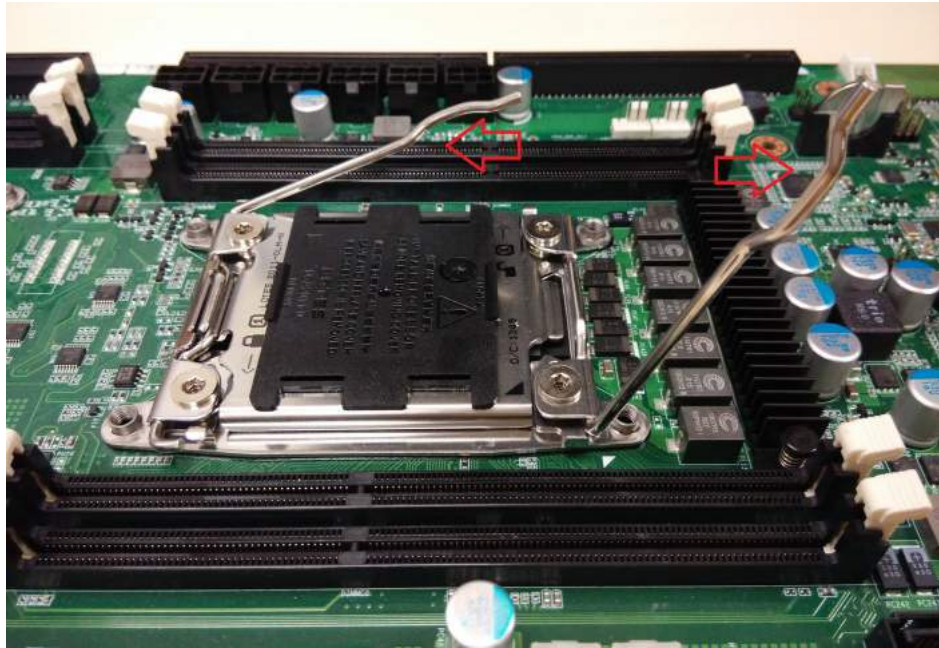

3. Push the CPU socket cover to a fully open position.

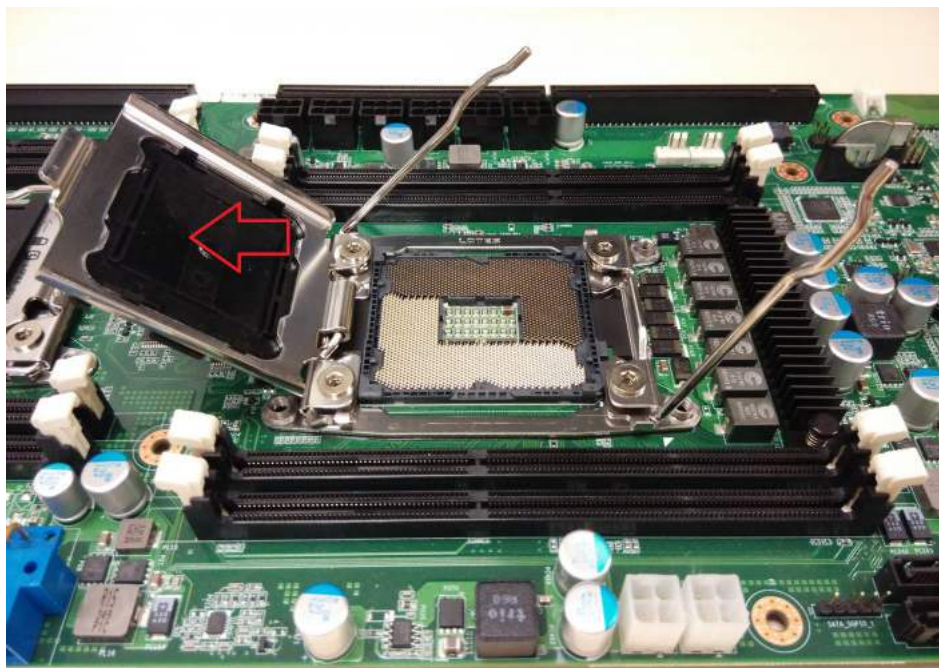

4. Place the CPU into the socket and make sure that the gold arrow is located in the right direction.

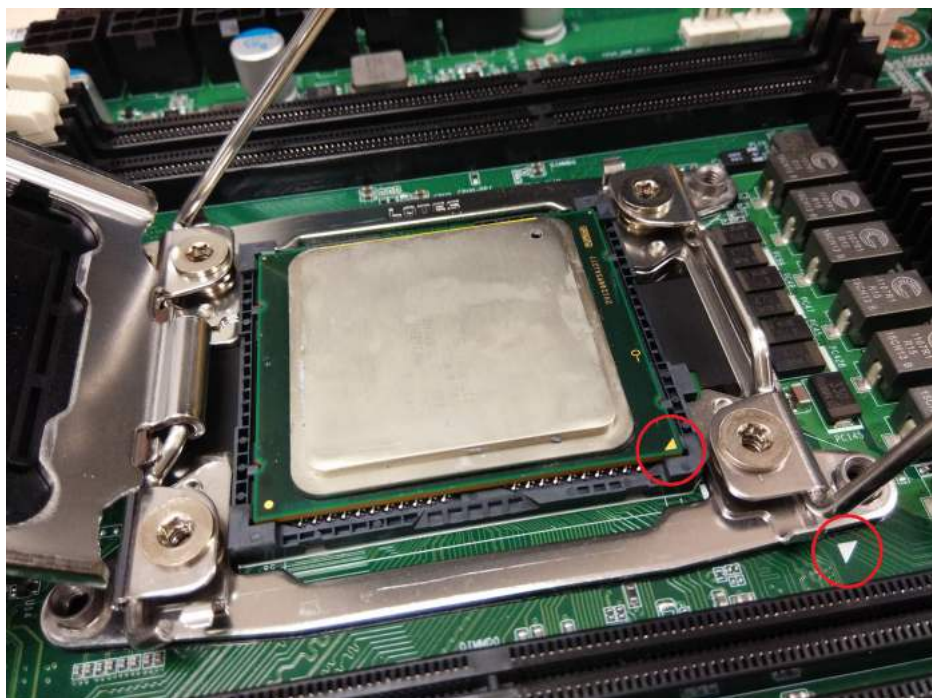

5. Take off the protection cap.

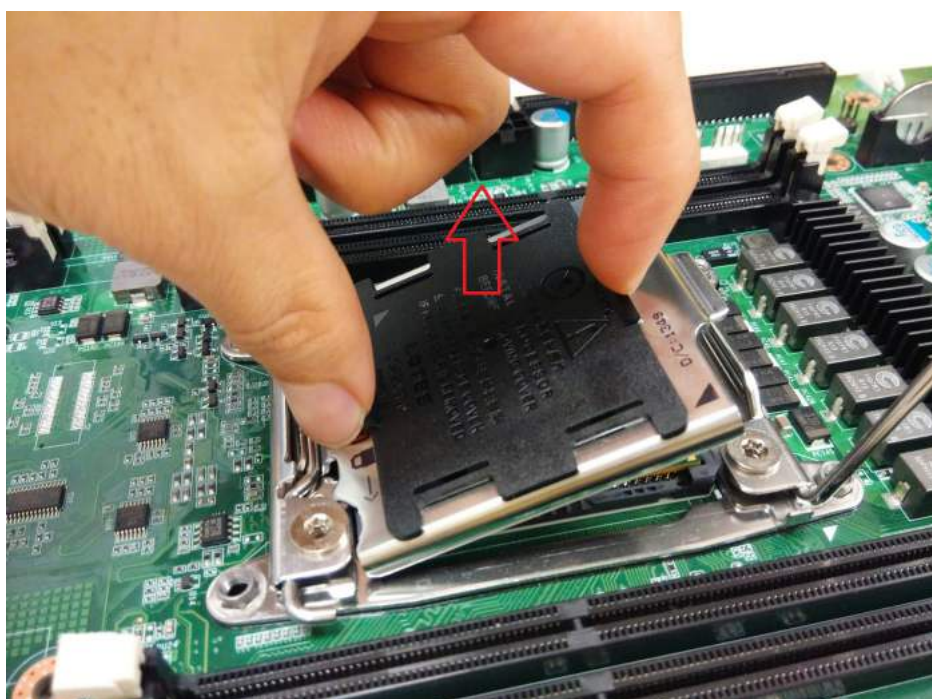

6. Close the CPU socket cover and press the lever down to secure the CPU.

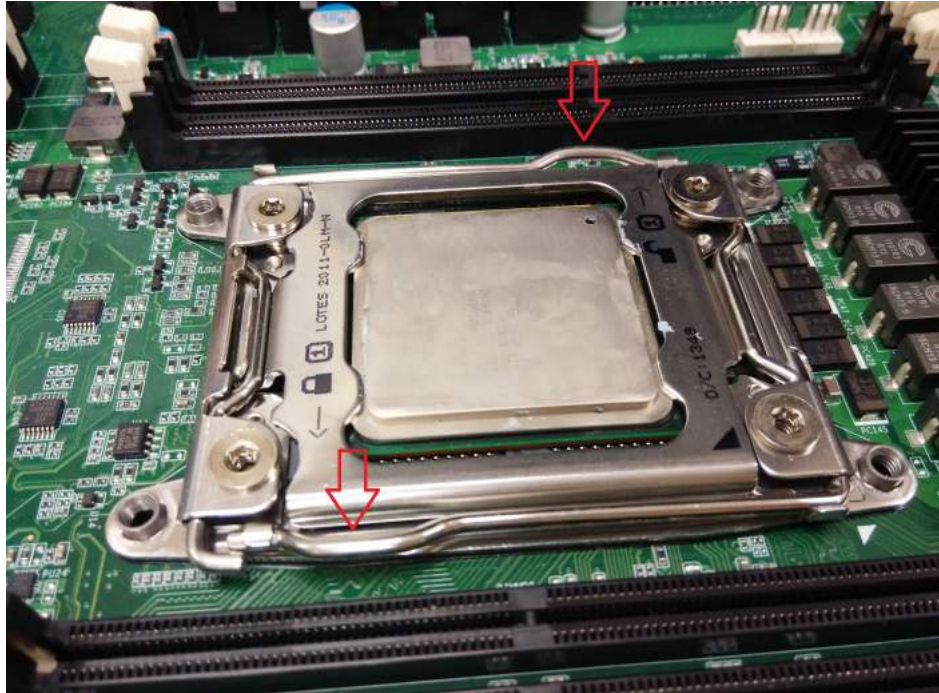

7. Position the heatsink on top of the CPU and secure it with 4 screws.

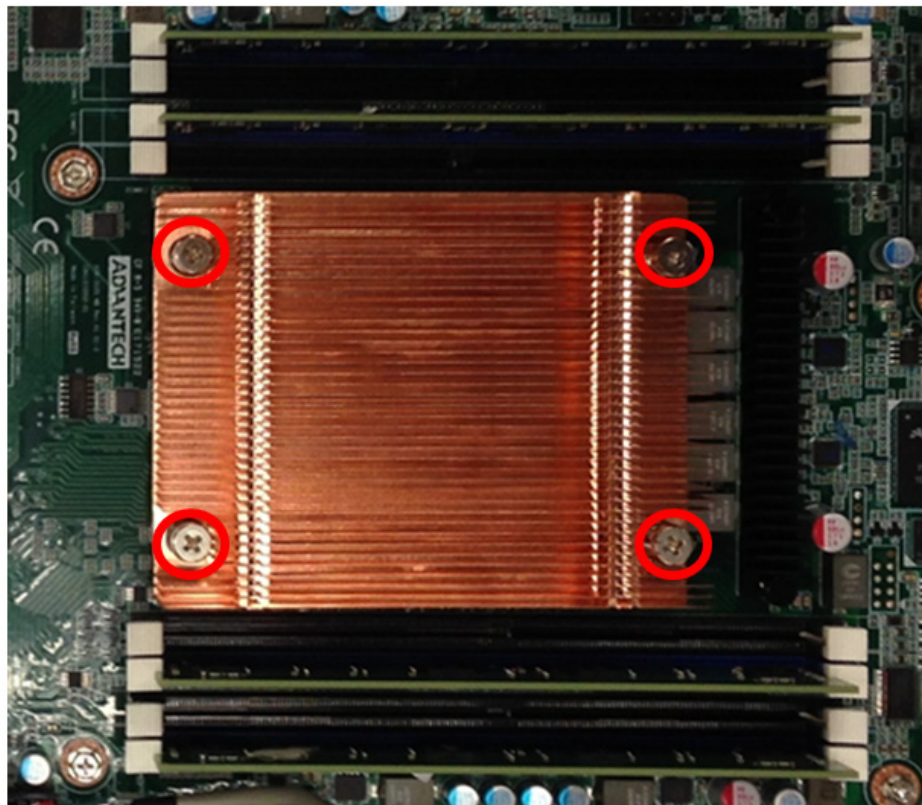

- Repeat the procedures earlier to install the second processor and heatsink. Now follow the below image for CPU heatsink installation.

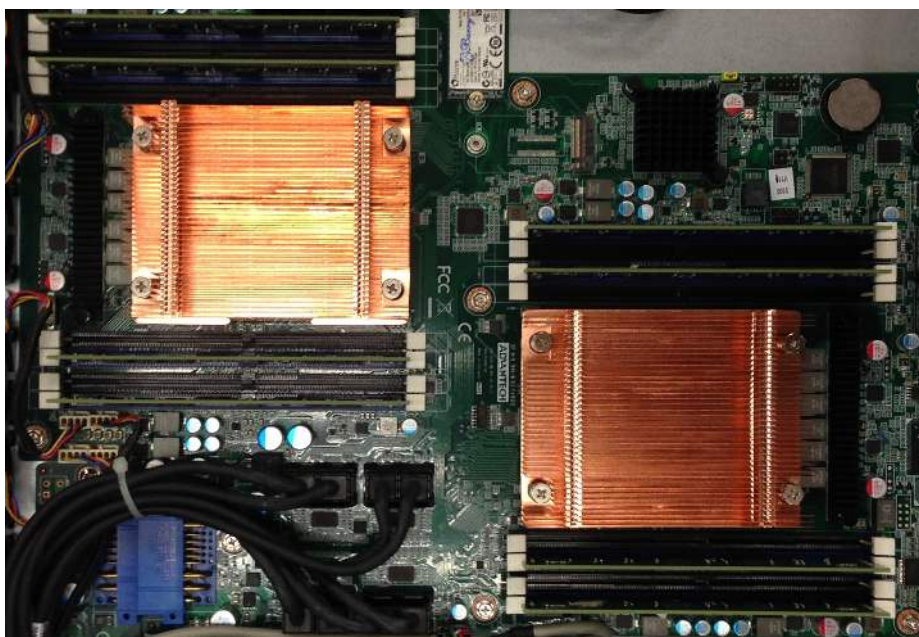

2.2.3 Installing the Memory

Follow these instructions to install the memory modules onto the motherboard.

- Locate the memory slots on the motherboard.
- Press the memory slot locking levers in the direction of the arrows as shown in the following illustration.

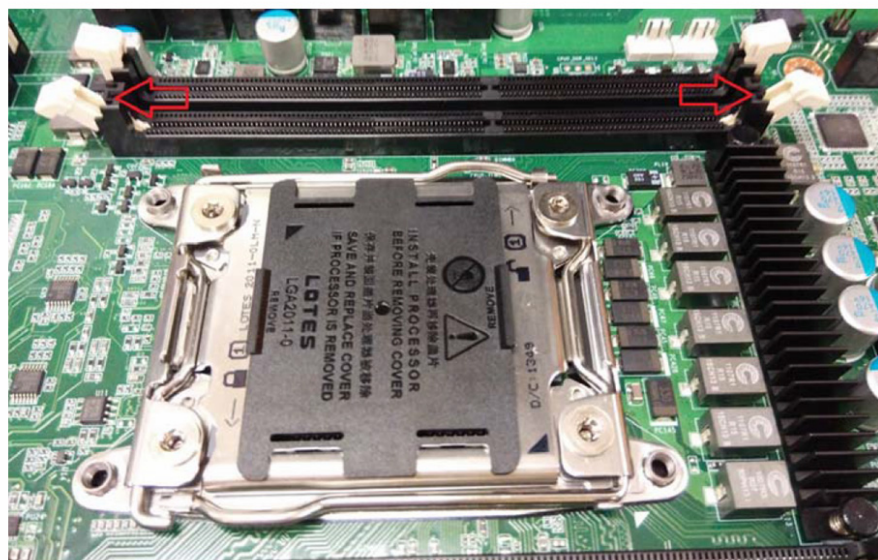

3. Align the memory module with the slot. When inserted properly, the memory slot locking levers lock automatically onto the indentations at the ends of the module. Follow the recommended memory population table to install the other memory modules.

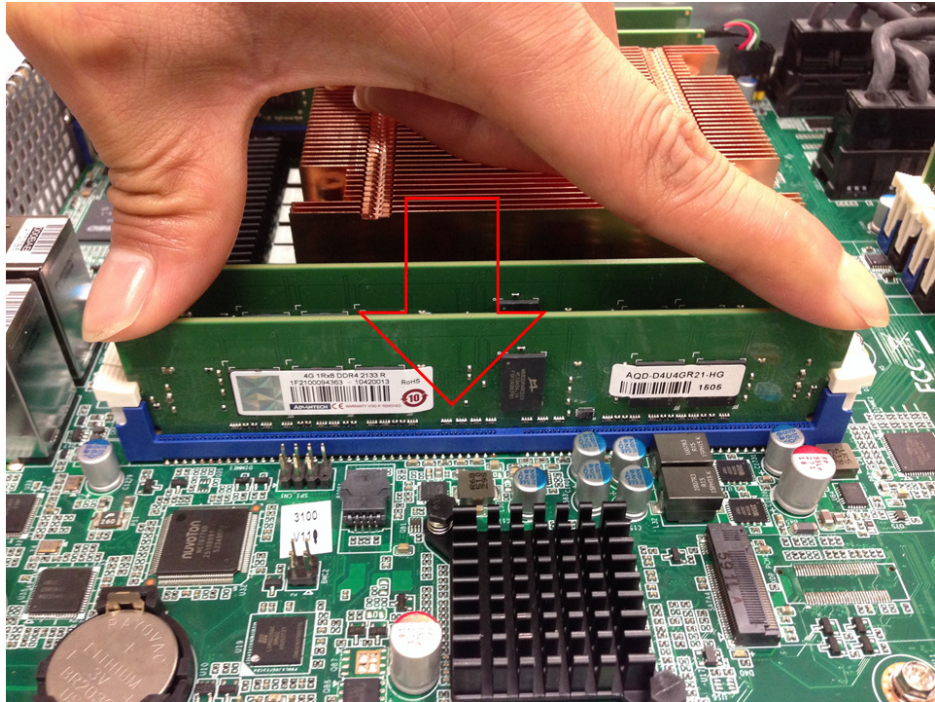

2.2.4 Installing Hard Drives

The ASR-3100 supports sixteen 2.5" hard drives. Follow these instructions to install a hard drive.

1. Press the locking lever latch and pull the locking lever open.



2. Slide the HDD tray out.

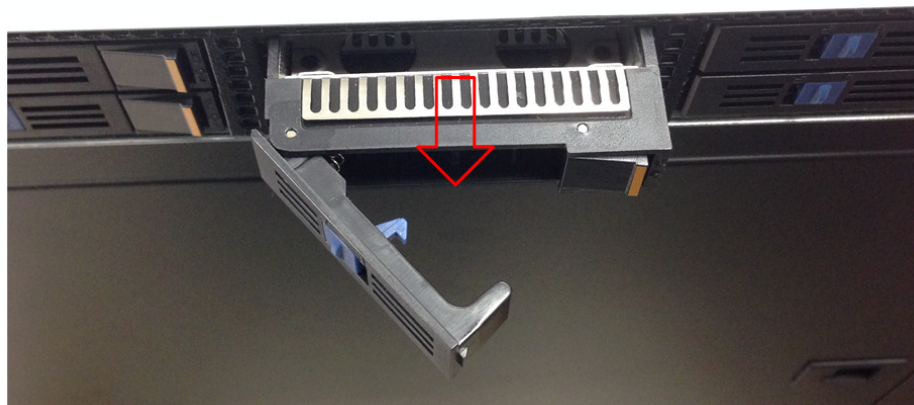

3. Place a hard drive into the drive tray, then use the screws to secure the HDD.

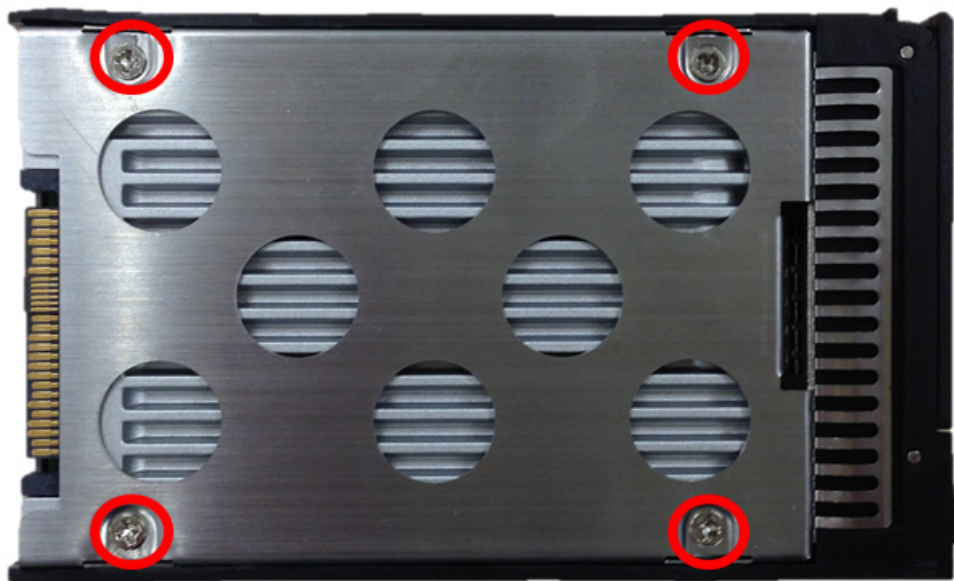

4. Reinsert the HDD tray into the chassis and press the locking lever to secure the tray.

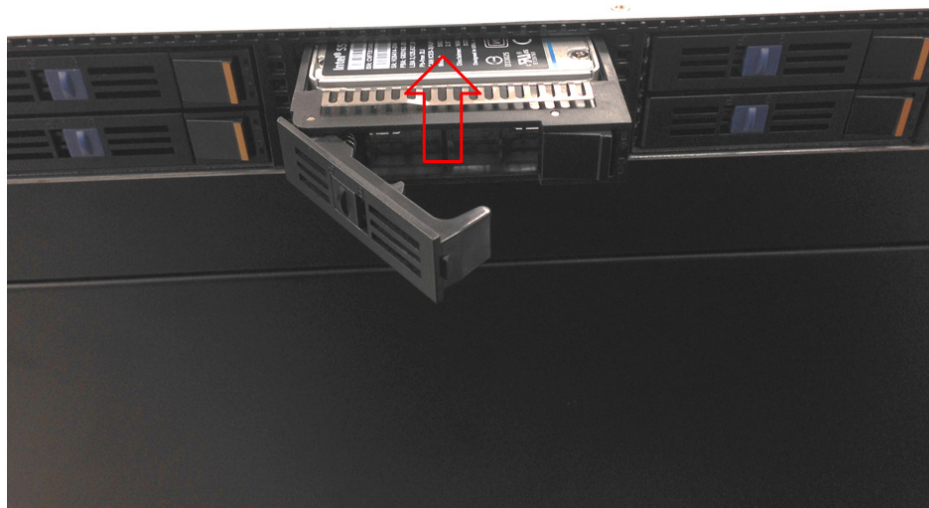

2.2.5 Installing PCIe x8 Expansion Card

The ASR-3100 supports two PCIe x8 expansion slots. The upper slot is from CPU0 supports FHHL card, and the bottom slot is from CUP1 supports HHHL card.

Note! Both card must be equipped with full-height bracket, even the expansion card is low-profile/half height.



Please follow these instructions to install the expansion cards.
(We use PCIe x8 SAS Raid Card as sample).

1. Unscrew the riser card bracket and release the PCIe x8 riser card.

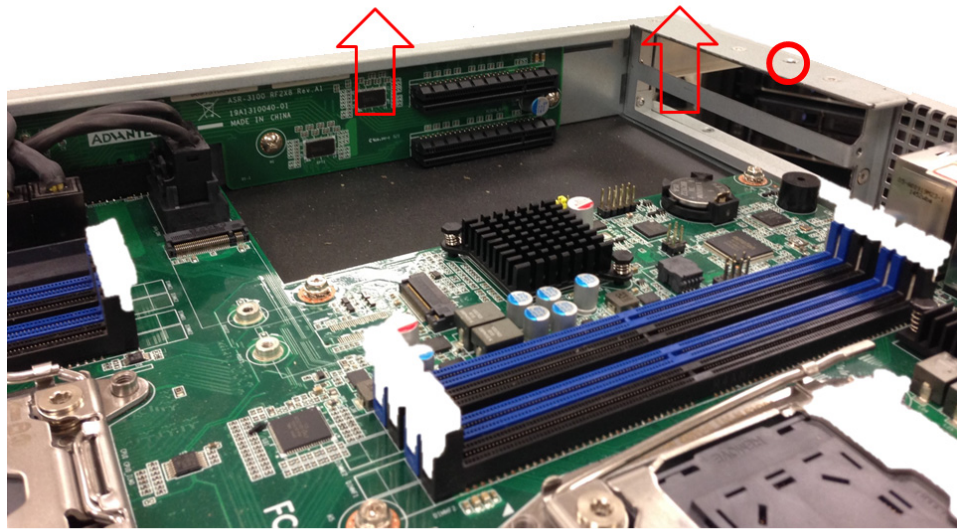

2. Install the expansion card onto the riser card. and screw it onto the riser card bracket.



3. Install the riser card with expansion card into the chassis and secure it.

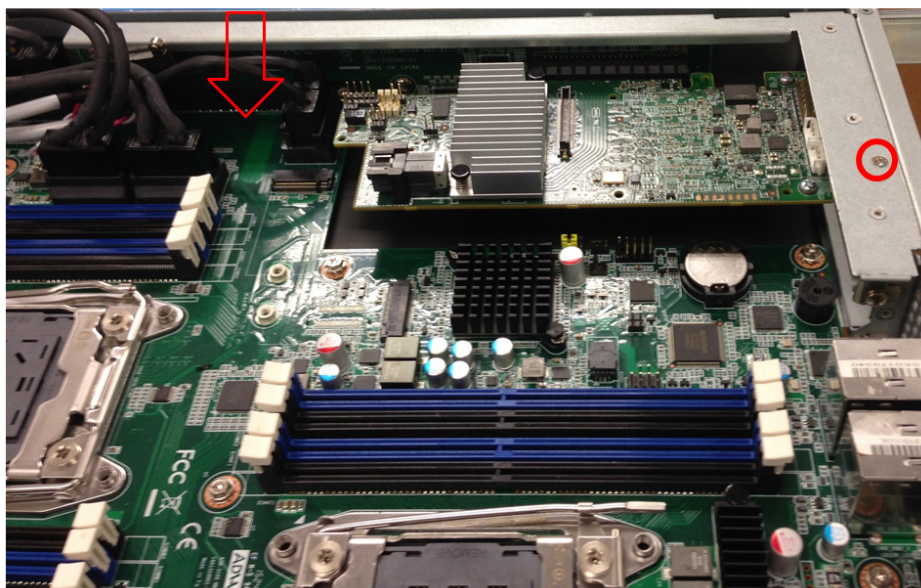

4. Install the mini-SAS HD cable into the expansion card.

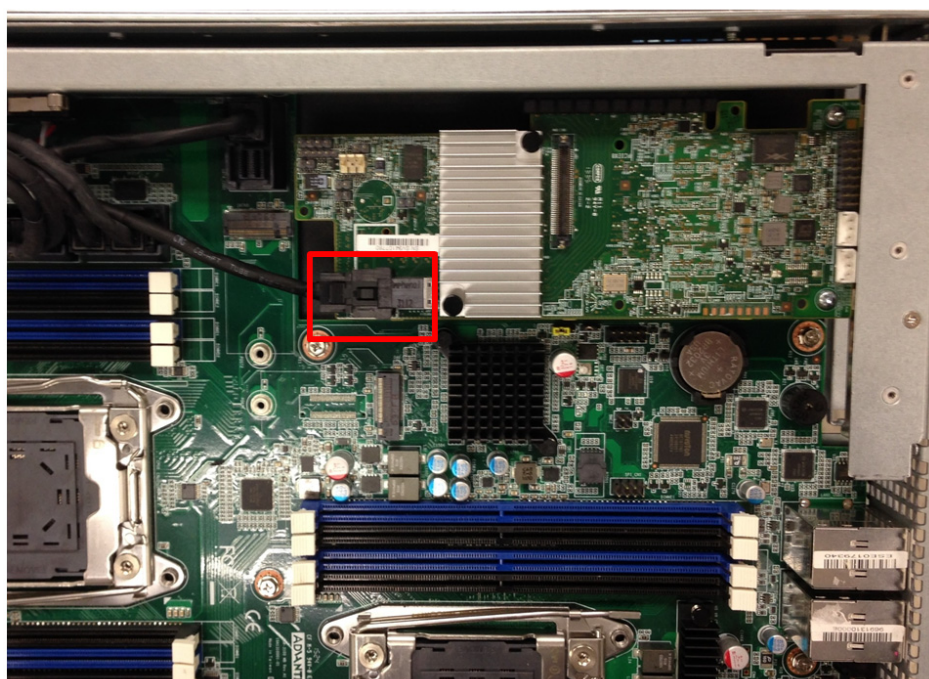

2.3 Rack Mounting

After installing the necessary components, the ASR-3100 can be mounted in a rack using the supplied rack mounting kit. We strongly recommend that the minimum depth of cabinets is 1100mm.

Rack mounting kit

- Sliding Rails x 2
- Convert bracket x 4
- Screws Kit x 3

2.3.1 Installing the Server in a Rack

Before mounting the ASR-3100 in a rack, ensure that all internal components have been installed and that the unit has been fully tested. Both side of chassis ear must be assembled before you assemble the slide rail kit.



Follow these instructions to mount the ASR-3100 into an industry standard 32" rack.

Screws list

M5 x16

M4 x9

1. Remove the chassis (inner) member.
Pull the slide open. Then press the trigger down as shown on the drawing, and pull the chassis (inner) member out.

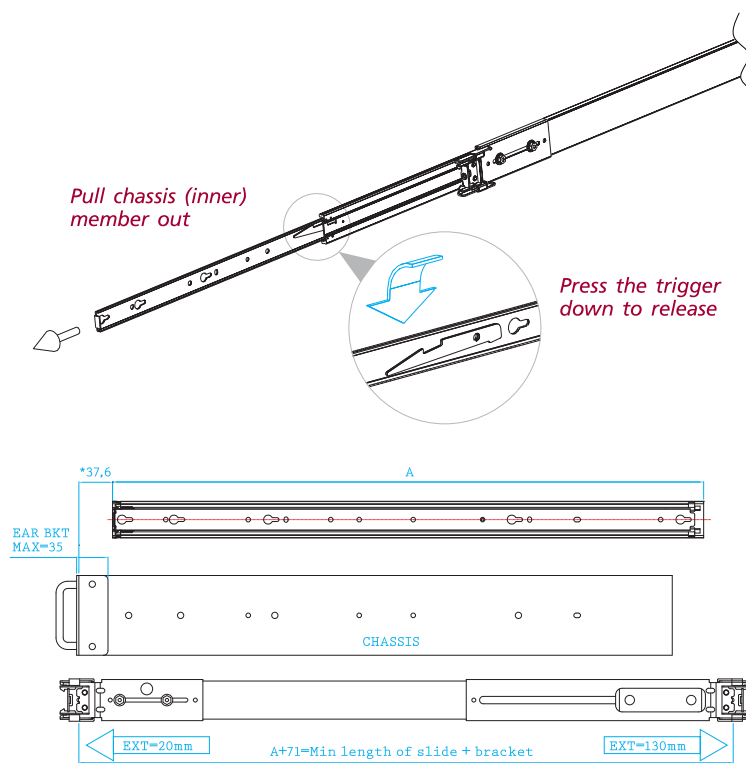

**Extendable front bracket only apply to some Tool-less model

2. Mount the chassis (inner) member to the chassis.
Each side of chassis uses 4 of screws or standoffs for slide attachment.

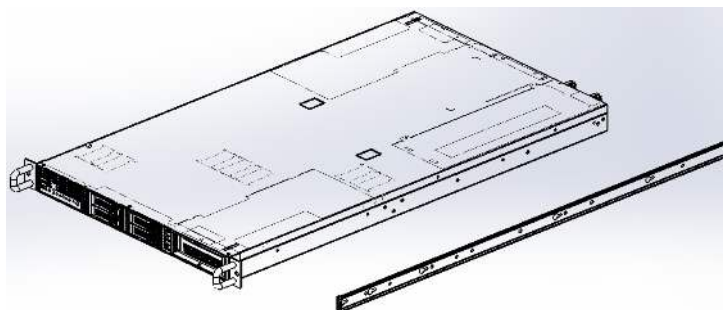

3. Attach the cabinet (outer) member to the rail.
Insert the stag into the upper and lower square holes on EIA rail from the back of rail. Push the safety lock forward to secure the bracket. It is important to check if the safety lock is in the unlocked position before mounting the brackets.

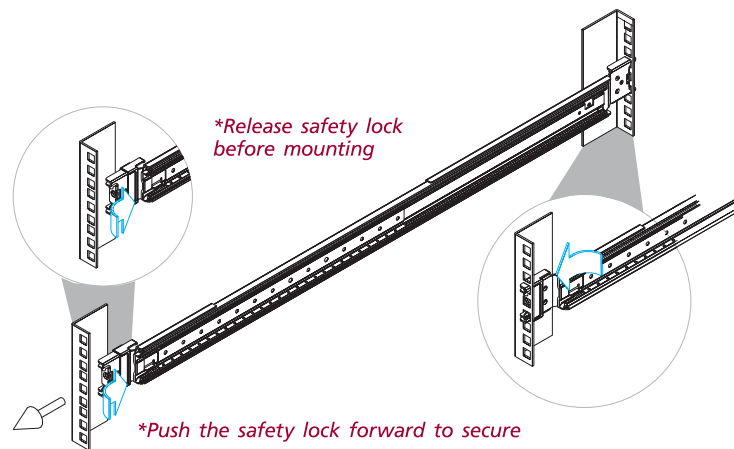

Uninstall the bracket

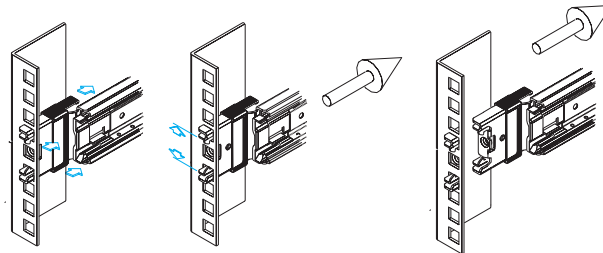

4. Mount the chassis into the cabinet.
Insert the chassis (inner) member into the cabinet as shown on the drawing. It is important to check if the ball retainer is in the fully open position before installing the chassis. Otherwise, it might cause catastrophic damage to the chassis if the ball retainer is not in the fully open position while mounting the chassis. While you are pushing the chassis back into the cabinet, you need to release the slide from its locking position by pressing the trigger down.

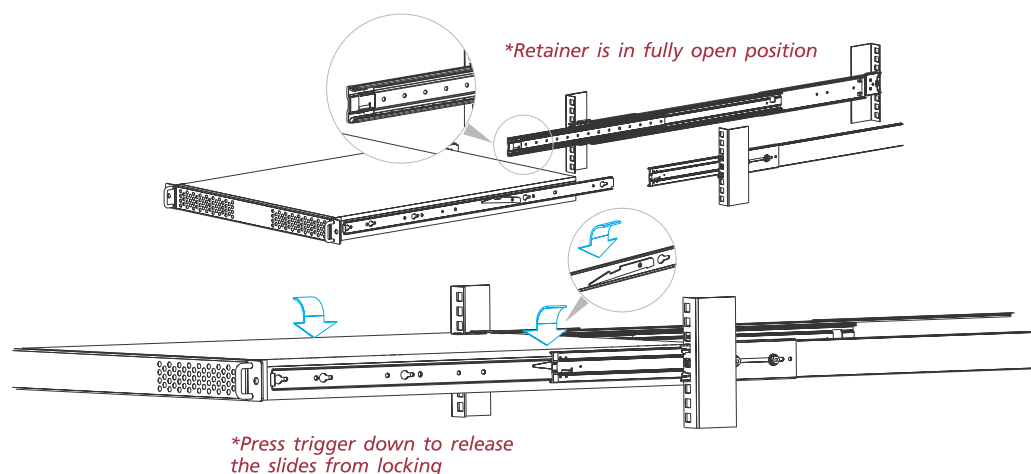

Note! *Rack Mount Instructions - The following or similar rack-mount instructions are included with the installation instructions:*



- *Elevated Operating Ambient - If installed in a closed or multi-unit rack assembly, the operating ambient temperature of the rack environment may be greater than room ambient temperature. Therefore, consideration should be given to installing the equipment in an environment compatible with the maximum ambient temperature (T_{ma}) specified by the manufacturer.*
- *Reduced Air Flow - Installation of the equipment in a rack should be such that the amount of air flow required for safe operation of the equipment is not compromised.*
- *Mechanical Loading - Mounting of the equipment in the rack should be such that a hazardous condition is not achieved due to uneven mechanical loading.*
- *Circuit Overloading - Consideration should be given to the connection of the equipment to the supply circuit and the effect that overloading of the circuits might have on overcurrent protection and supply wiring. Appropriate consideration of equipment nameplate ratings should be used when addressing this concern.*
- *Reliable Earthing - Reliable earthing of rackmounted equipment should be maintained. Particular attention should be given to supply connections other than direct connections to the branch circuit (e.g. use of power strips).*

Instructions de montage en rack - Le rack en suivant ou similaire - monter instructions sont incluses avec les instructions d'installation:

- *Température de fonctionnement élevée - il est installé dans une unité fermée ou plusieurs Ensemble formant bâti, la température ambiante de fonctionnement de l'environnement de l'armoire peut être supérieure à la chambre ambiante. Par conséquent, il devrait être donnée à l'installation de l'équipement dans un environnement compatible avec la température ambiante maximale (T_{ma}) spécifiée par le fabricant.*
- *Débit d'air réduit - Installation de l'équipement dans un rack doit être tel que la quantité de flux d'air nécessaire au bon fonctionnement de l'appareil ne soit pas compromise.*
- *Chargement mécanique - Le montage de l'équipement dans le rack doit être telle qu'une situation dangereuse ne soit générée à inégale chargement mécanique.*
- *Surcharge du circuit - Il faut tenir compte à la connexion de l'équipement au circuit d'alimentation et l'effet que la surcharge des circuits pourrait avoir sur la protection contre les surintensités et le câblage d'alimentation. Considération appropriée de l'équipement plaque signalétique évaluations doivent être utilisés pour répondre à cette préoccupation.*
- *Fiabilité de la mise - Fiable mise à la terre de l'équipement monté en rack doit être maintenue. Une attention particulière devrait être accordée à fournir connexions autres que les connexions directes sur le circuit de branche (par exemple l'utilisation de multiprises).*

Chapter 3

AMI BIOS

3.1 Introduction

With the AMI BIOS Setup program, you can modify BIOS settings and control the special features of your system. The Setup program uses a number of menus for making changes and turning the special features on or off. This chapter describes the basic navigation of the ASR-3100 setup screens.

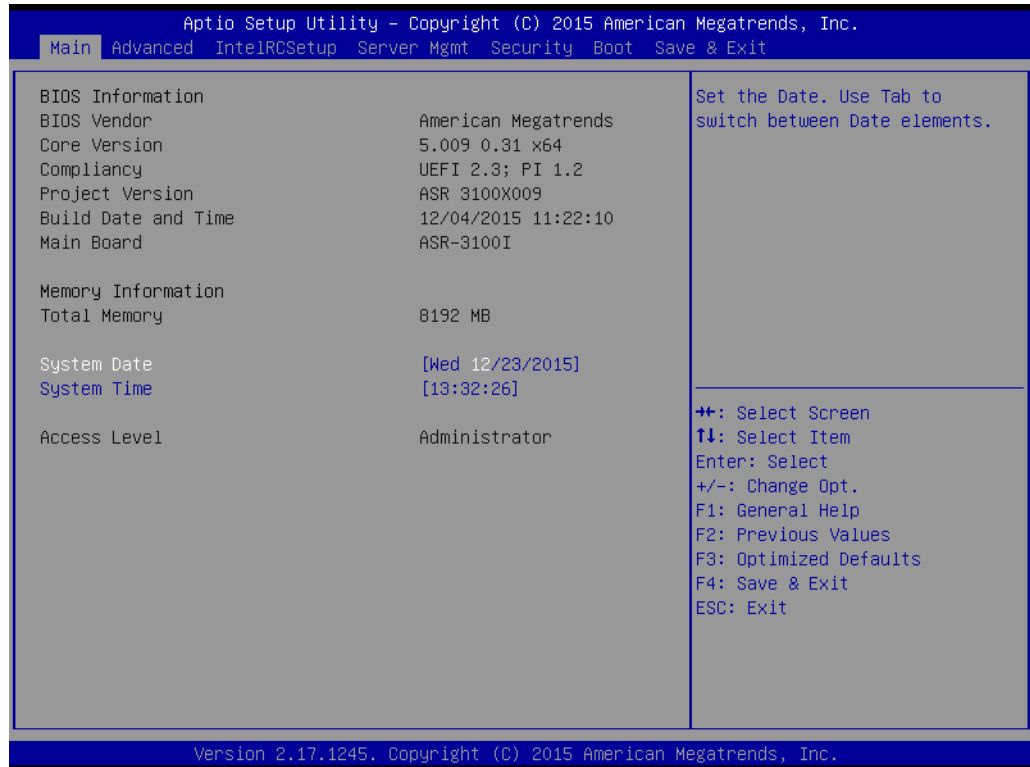

AMI's BIOS ROM has a built-in Setup program that allows users to modify the basic system configuration. This type of information is stored in battery-backed up CMOS so it retains the Setup information when the power is turned off.

Note! *The BIOS setup screens shown in this chapter are for reference only, they may not exactly match what you see on your display devices.*



3.2 BIOS Setup

3.2.1 Main Menu

Press during bootup to enter AMI BIOS CMOS Setup Utility; the Main Menu will appear on the screen. Use arrow keys to select among the items and press <Enter> to accept or enter the sub-menu.

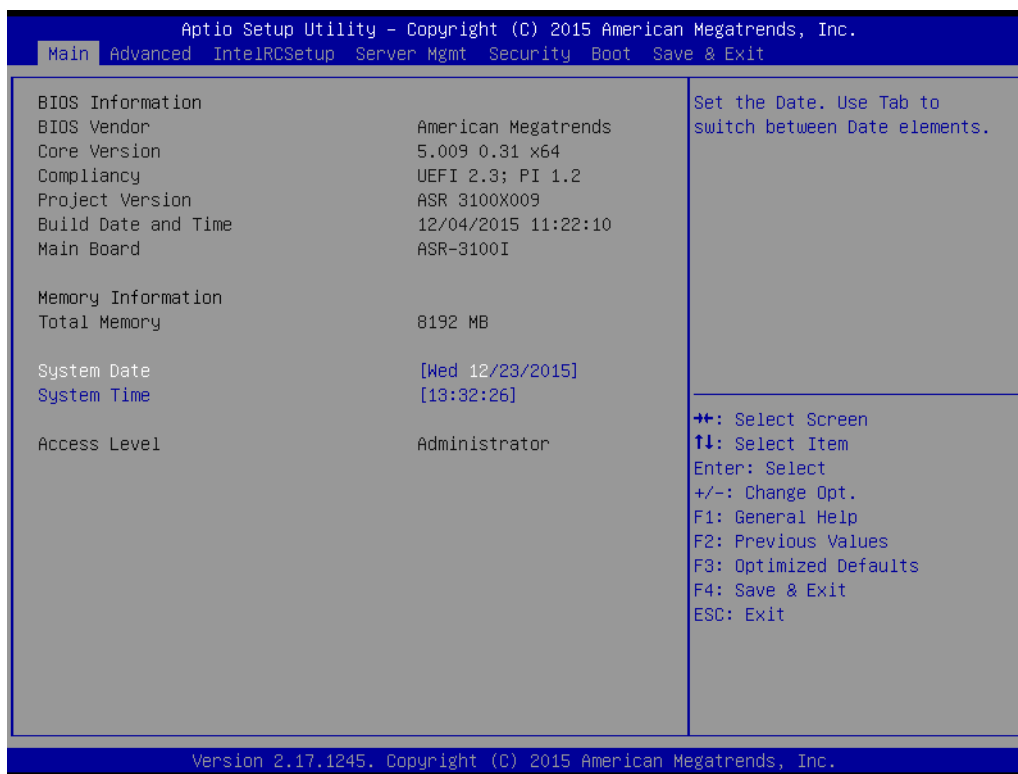

The Main BIOS setup screen has two main frames. The left frame displays all the options that can be configured. Grayed-out options cannot be configured; options in blue can be. The right frame displays the key legend. Above the key legend is an area reserved for a text message. When an option is selected in the left frame, it is highlighted in white. Often a text message will accompany it.

■ System Time / System Date

Use this option to change the system time and date. Highlight System Time or System Date using the <Arrow> keys. Enter new values through the keyboard. Press the <Tab> key or the <Arrow> keys to move between fields. The date must be entered in MM/DD/YY format. The time must be entered in HH:MM:SS format.

3.2.2 Advanced BIOS Features Setup

Select the Advanced tab from the ASR-3100 setup screen to enter the Advanced BIOS setup screen. You can select any of the items in the left frame of the screen, such as CPU configuration, to go to the sub menu for that item. You can display an Advanced BIOS Setup option by highlighting it using the <Arrow> keys. All Advanced BIOS Setup options are described in this section. The Advanced BIOS Setup screens are shown below. The sub menus are described on the following pages.

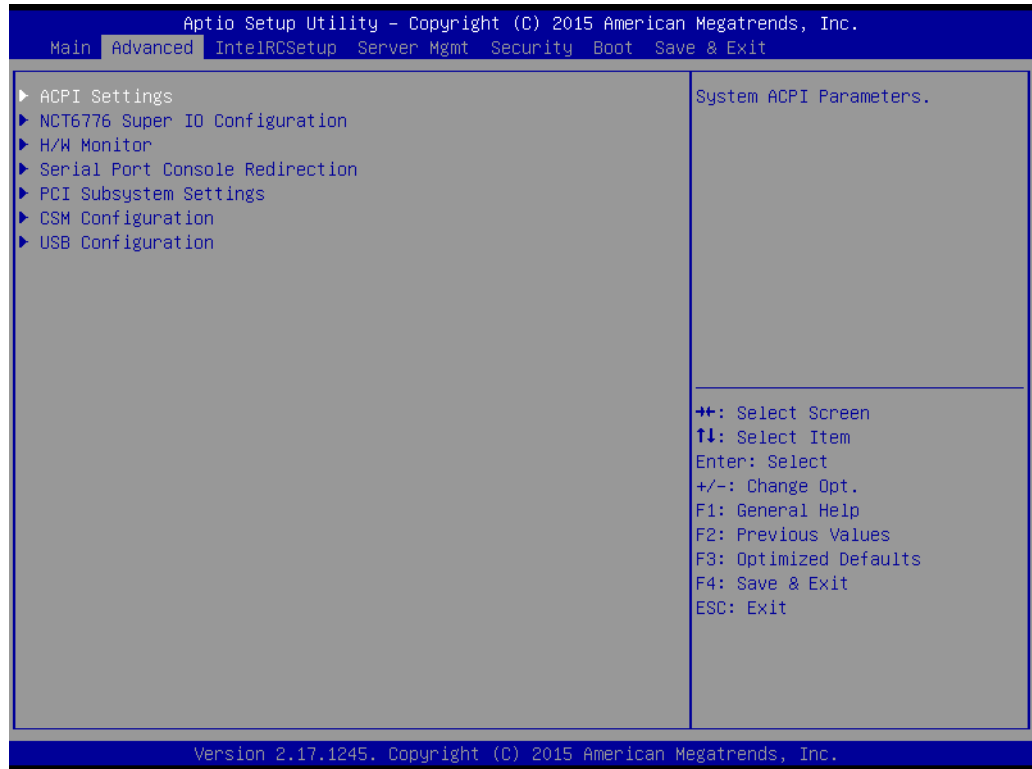

3.2.2.1 ACPI Settings



- **Enable Hibernation**
"Enable or disable" Hibernation.
- **Lock Legacy Resources**
"Enable" or "Disable" Lock Legacy Resources.

3.2.2.2 NCT6776 Super IO Configuration

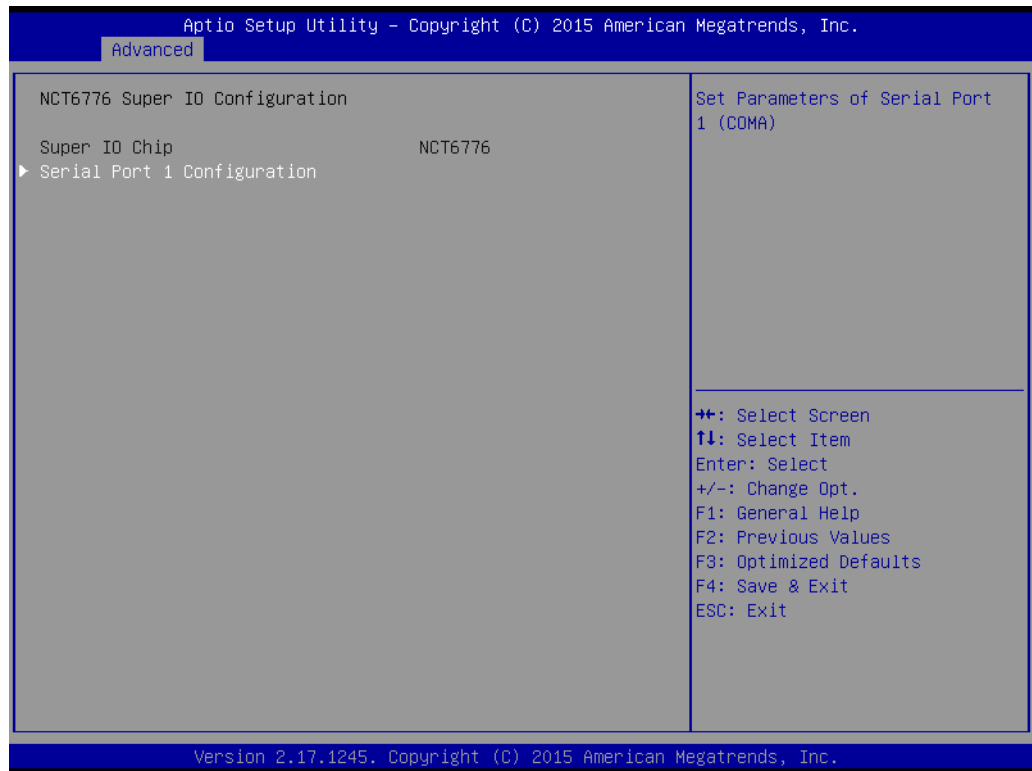

■ Serial Port 1 Configuration

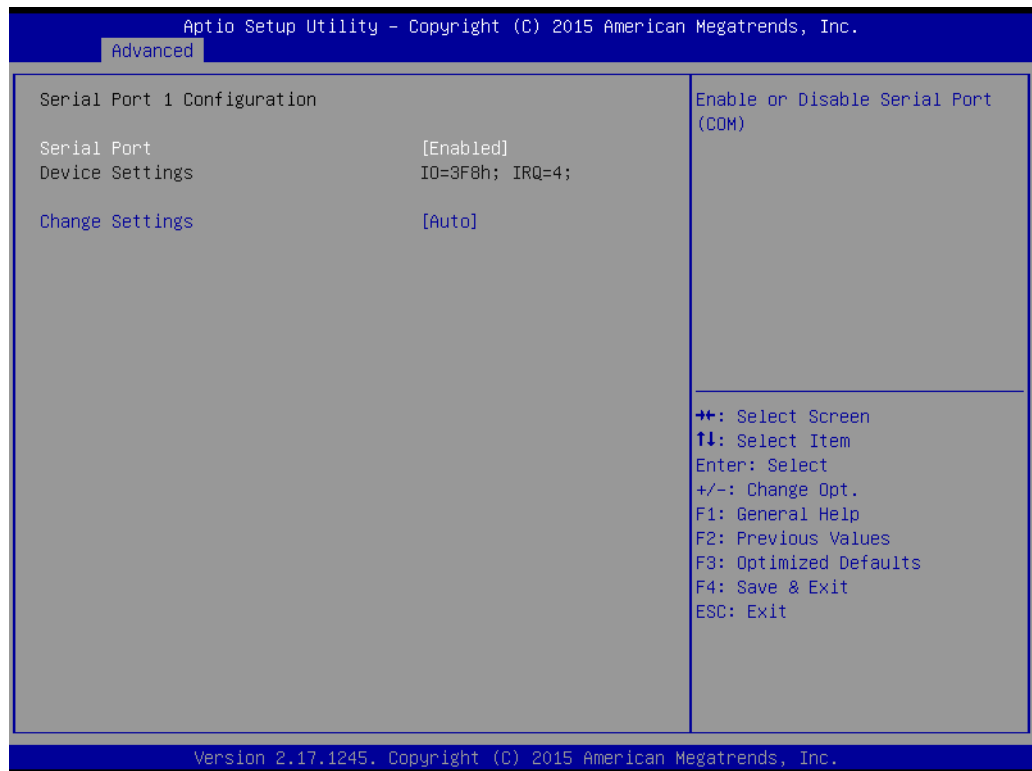

- **Serial Port**
“Enable” or “Disable” Serial Port 1.
- **Change Settings**
To select an optimal setting for serial port 1.

3.2.2.3 H/W Monitor

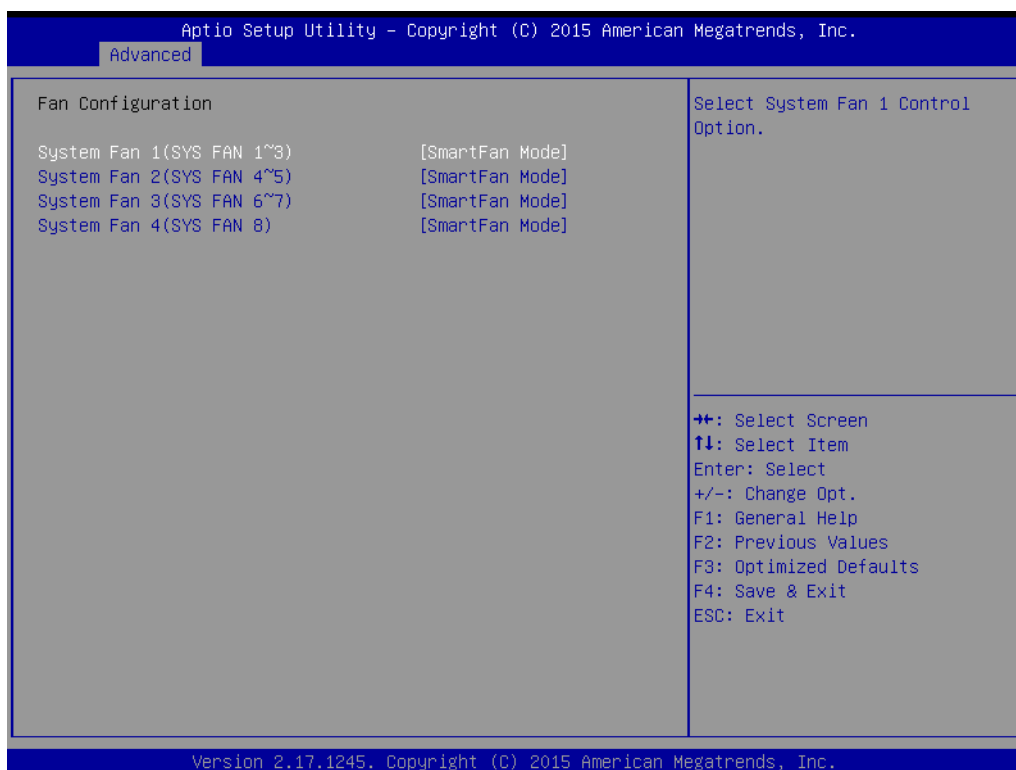
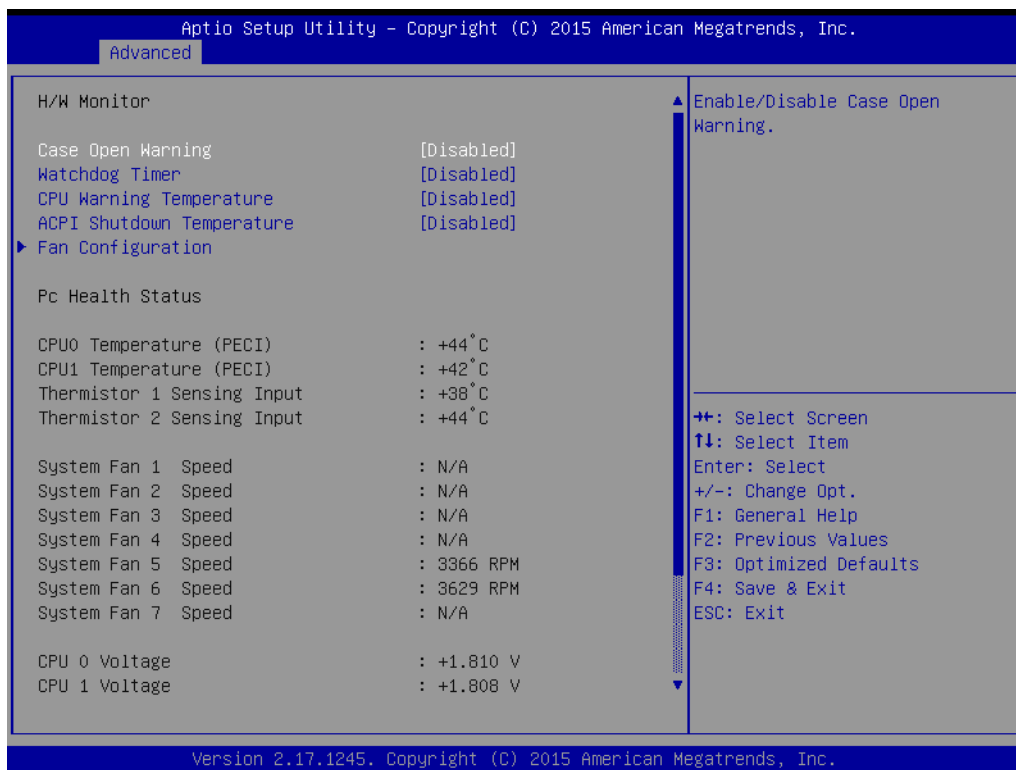

- **Case Open Warning**
Enable/Disable the Chassis Intrusion monitoring function. When enabled and the case is opened, the warning message will show in POST screen.
- **Watchdog Timer**
Enable and Disable the watchdog timer function.
- **CPU Warning Temperature**
Set the CPU warning temperature threshold. When the system reaches the warning temperature, the speaker will beep.
- **ACPI Shutdown Temperature**
Set the ACPI shutdown temperature threshold. When the system reaches the shutdown temperature, it will be automatically shut down by ACPI OS to protect the system from overheating damage.
- **Fan Configuration**
When set to manual mode, fan duty setting can be changed; the range is from 10%~100%, default setting is 100%.

3.2.2.4 Serial Port Console Redirection

- **Console Redirection**
To “Enable or disable” console redirection feature.

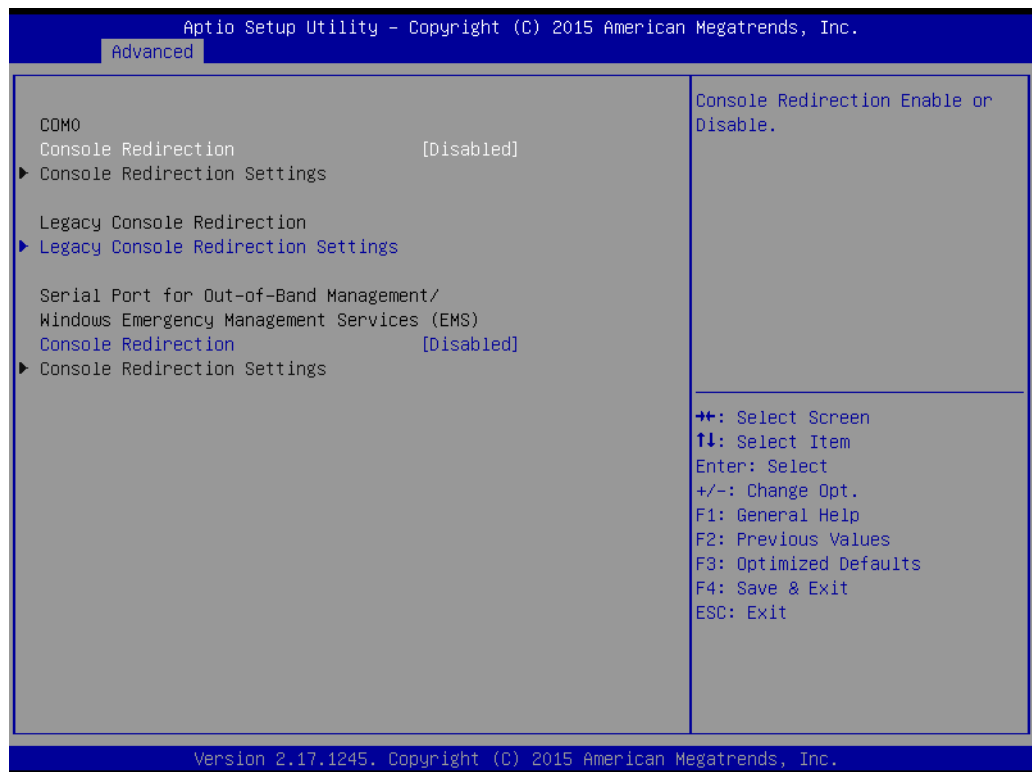

■ Console Redirection Settings

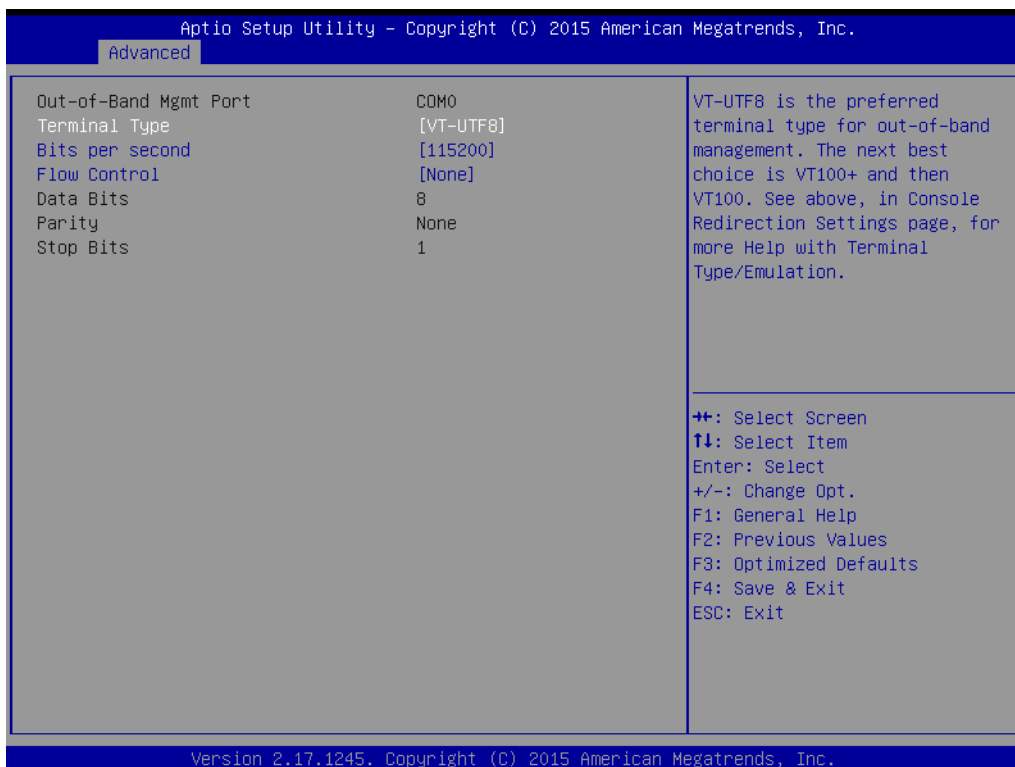
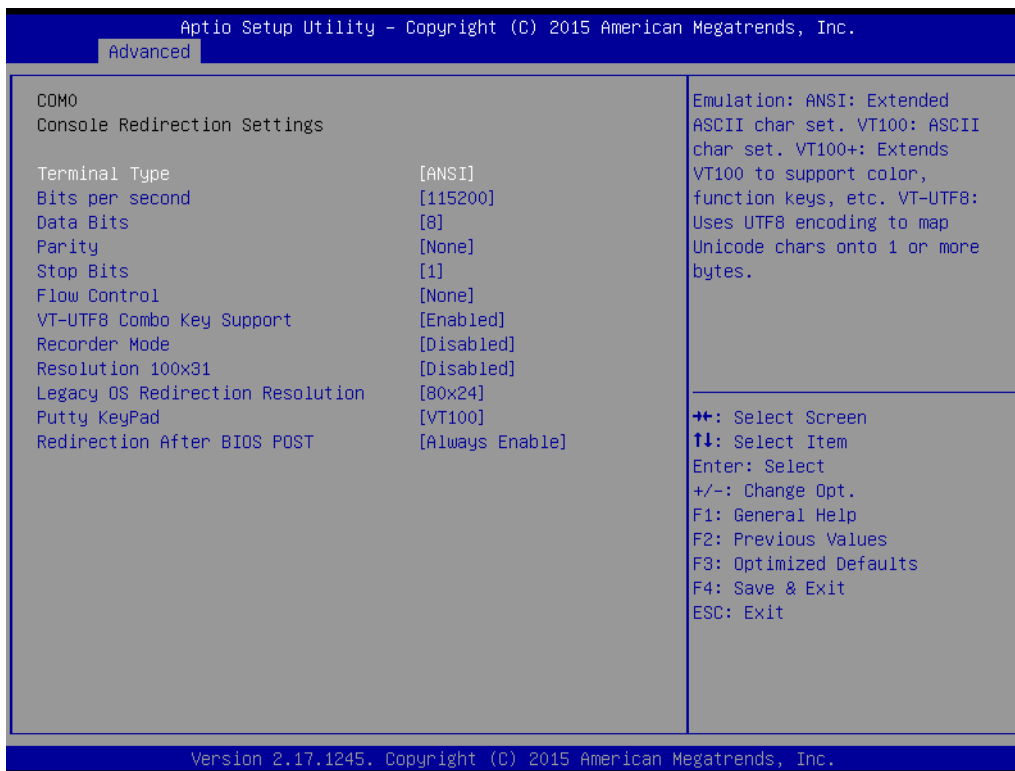

■ Terminal Type

Select a terminal type to be used for console redirection.

Options available: VT100/VT100+/ANSI /VT-UTF8.

-
- **Bits Per Second**
Select the baud rate for console redirection.
Options available: 9600/19200/57600/115200.
 - **Parity**
A parity bit can be sent with the data bits to detect some transmission errors.
Even: parity bit is 0 if the number of 1's in the data bits is even.
Odd: parity bit is 0 if number of 1's the data bits is odd.
Mark: parity bit is always 1. Space: Parity bit is always 0.
Mark and Space Parity do not allow for error detection.
Options available: None/Even/Odd/Mark/Space.
 - **Stop Bits**
Stop bits indicate the end of a serial data packet. (A start bit indicates the beginning).
The standard setting is 1 stop bit. Communication with slow devices may require more than 1 stop bit.
Options available: 1/2.
 - **Flow Control**
Flow control can prevent data loss from buffer overflow. When sending data, if the receiving buffers are full, a 'stop' signal can be sent to stop the data flow.
Once the buffers are empty, a 'start' signal can be sent to re-start the flow. Hardware flow control uses two wires to send start/stop signals.
Options available: None/Hardware RTS/CTS.

 - **Recorder Mode**
When this mode enabled, only text will be send. This is to capture Terminal data.
Options available: Enabled/Disabled.
 - **Legacy OS Redirection Resolution**
On Legacy OS, the number of Rows and Columns supported redirection.
Options available: 80x24/80X25.
 - **Putty Keypad**
Select function key and keypad on putty.
 - **Redirection After BIOS Post**

3.2.2.5 PCI Subsystem Settings

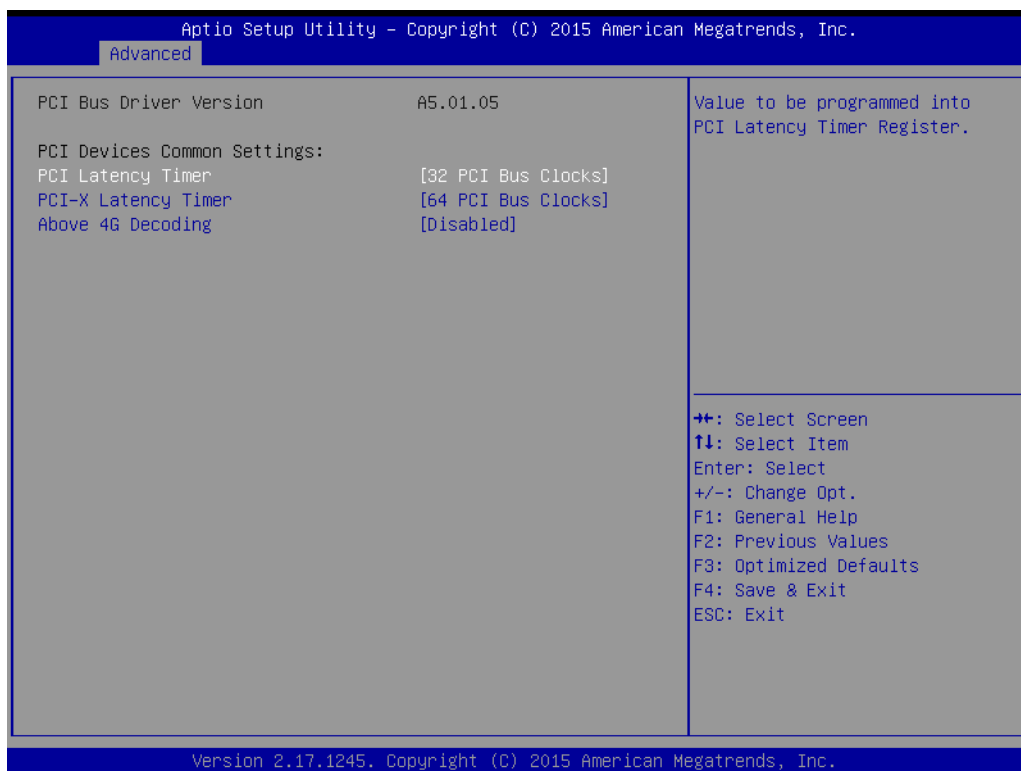

- Above 4G Decoding**
 Enables or disables 64-bit capability. Devices to be decoded in above 4G address space (Only if system supports 64-bit PCI decoding).

3.2.2.6 CSM Configuration

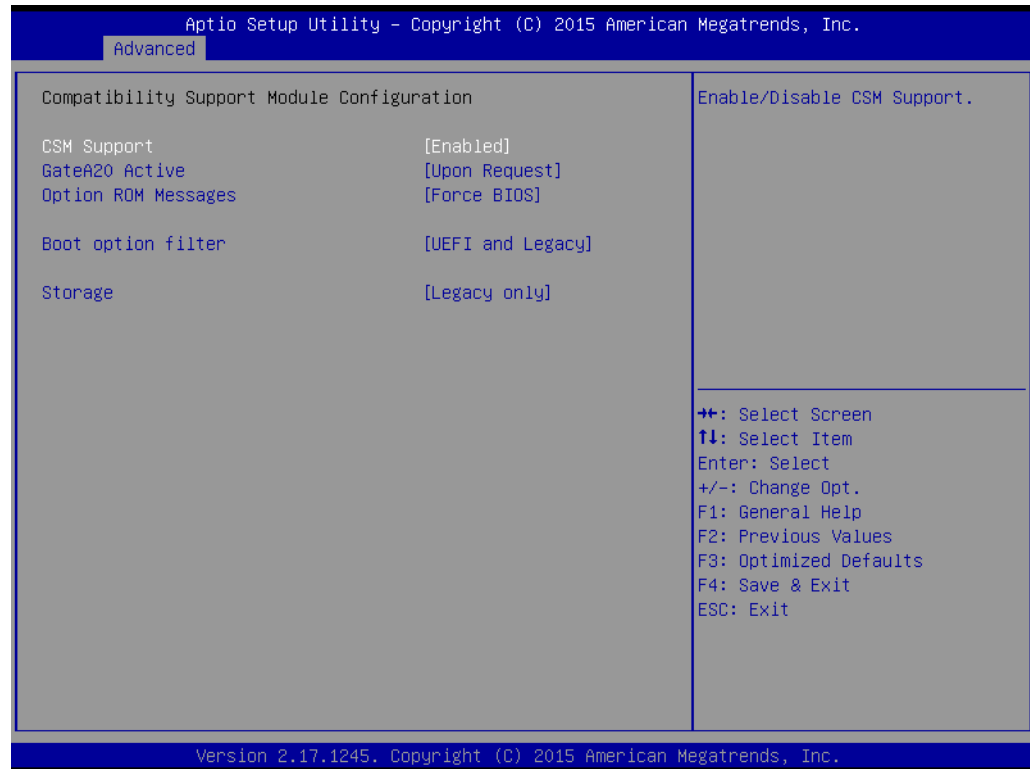

- **CSM Support**
Enable/Disable CSM Support
- **GateA20 Active**
UPON REQUEST - GA20 can be disabled using BIOS services.
This option is useful when any RT code is executed above 1MB.
- **Option ROM Message**
Set display mode for Option ROM.
- **Boot option filter**
You could choose boot from UEF/Legacy or Legacy only or UEFI only. If you want to boot from NVMe drive, please take the option of "UEFI and Legacy" or "UEFI only".
- **Storage**
Controls the execution of UEFI and legacy storage option ROM. Three options are that UEFI or legacy only or do not launch. If you want to boot from NVMe drive, please take the option of "UEFI".

3.2.2.7 USB Configuration

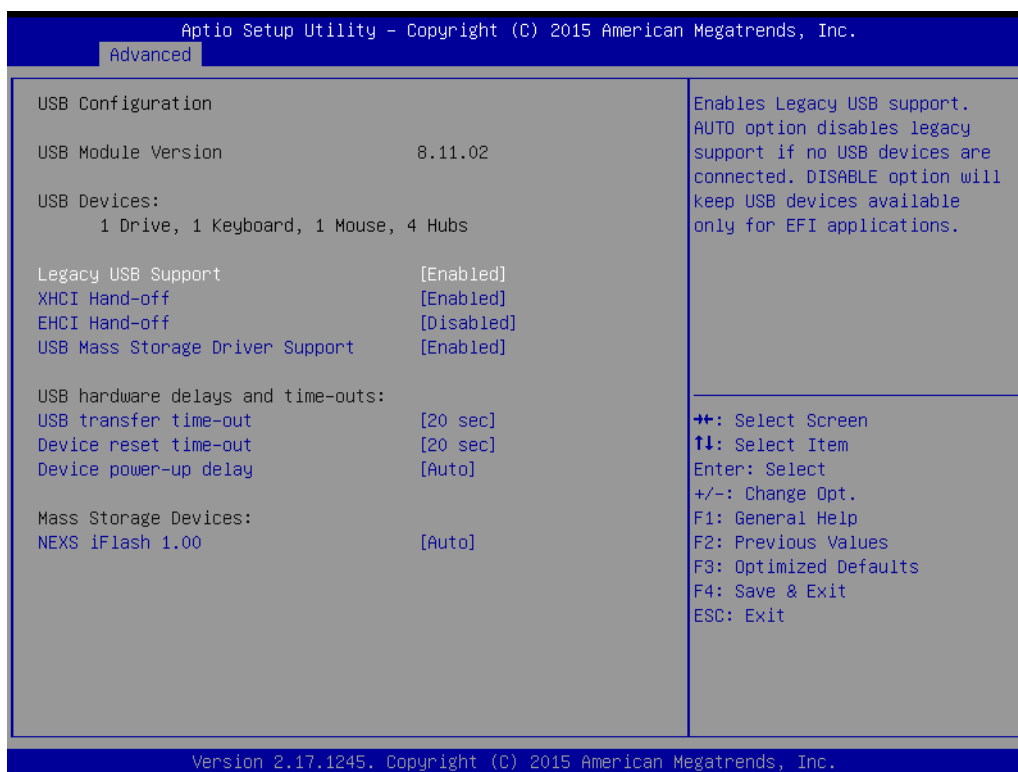

- **Legacy USB Support**
This supports USB devices under a legacy OS such as DOS. When choosing "AUTO", the system will automatically detect if any USB device is plugged into the computer and enable USB legacy mode or disable USB legacy mode when no USB device is attached.
- **XHCI Hand-off**
This is a workaround for OS without XHCI hand-off support. The XHCI ownership change should be claimed by XHCI driver.
- **EHCI Hand-off**
This is a workaround for OS without EHCI hand-off support. The EHCI ownership change should be claimed by EHCI driver.
- **USB Mass Storage Driver Support**
Enable/Disable USB mass storage driver support.
- **USB Transfer Time-out**
Selects the USB transfer time-out value. [1,5,10,20sec]
- **Device Reset Time-out**
Selects the USB device reset time-out value. [10,20,30,40 sec]
- **Device Power-up Delay**
This item appears only when Device power-up delay item is set to [manual].

3.2.3 Intel RC Setup

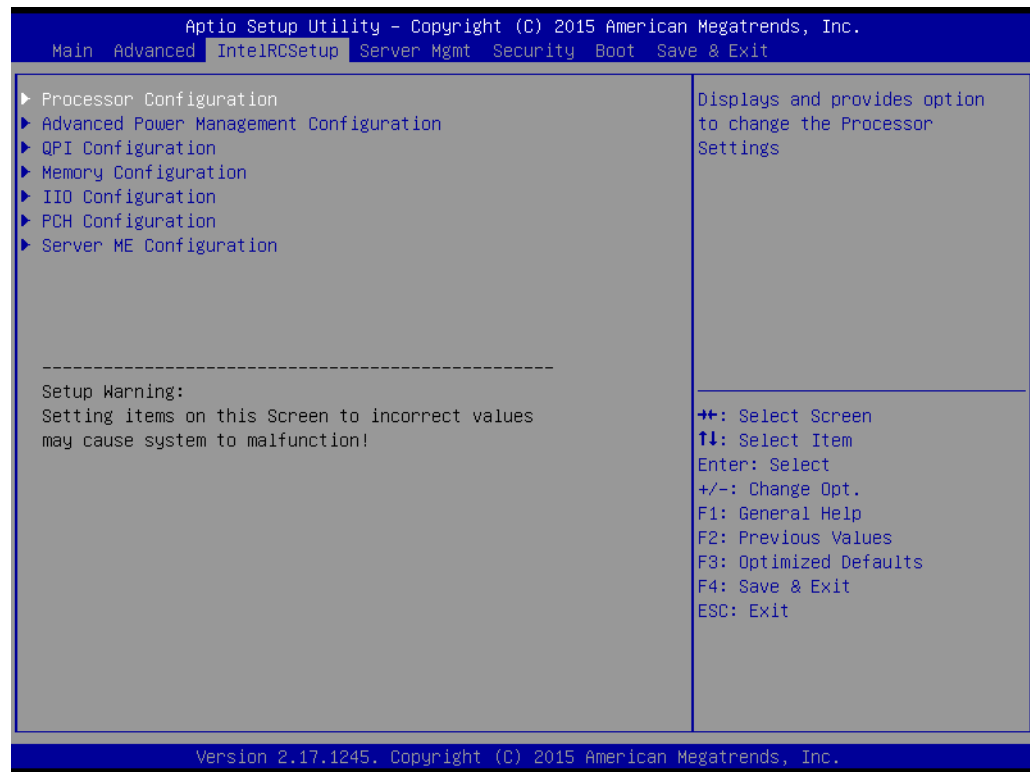

3.2.3.1 Processor Configuration

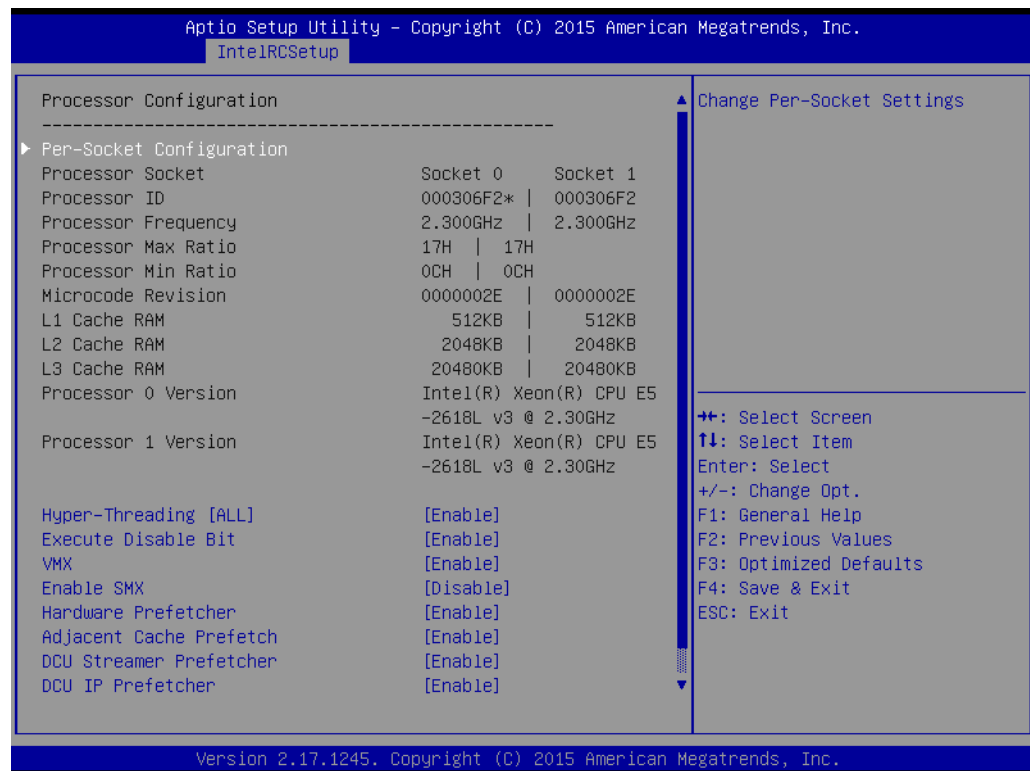

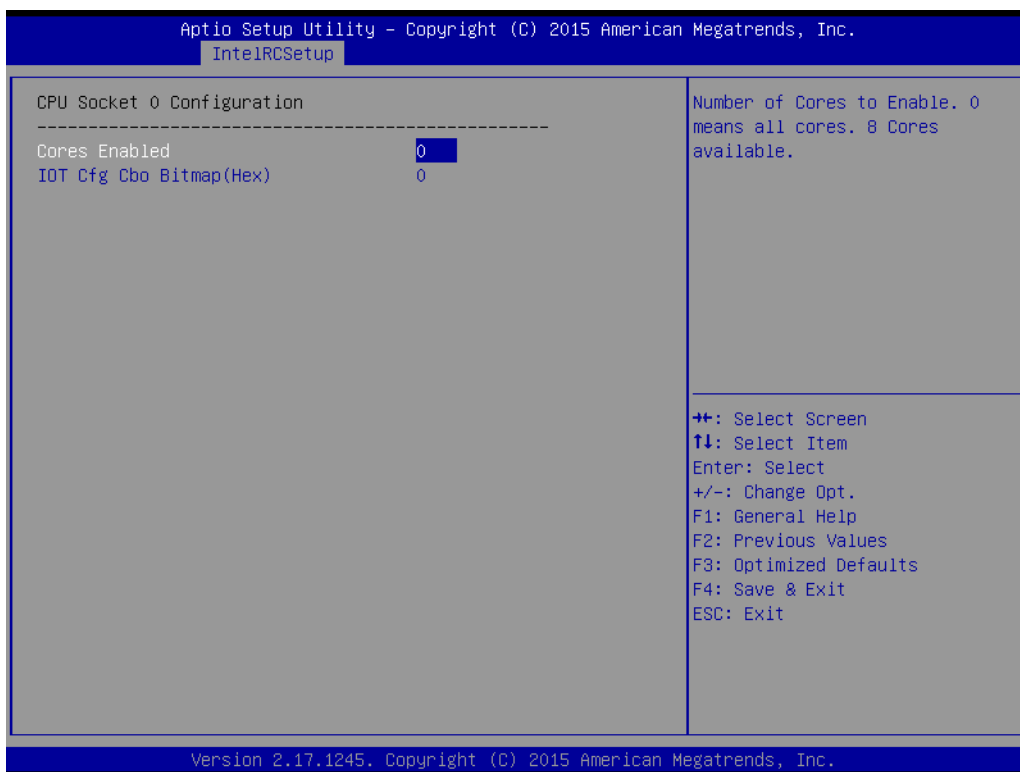
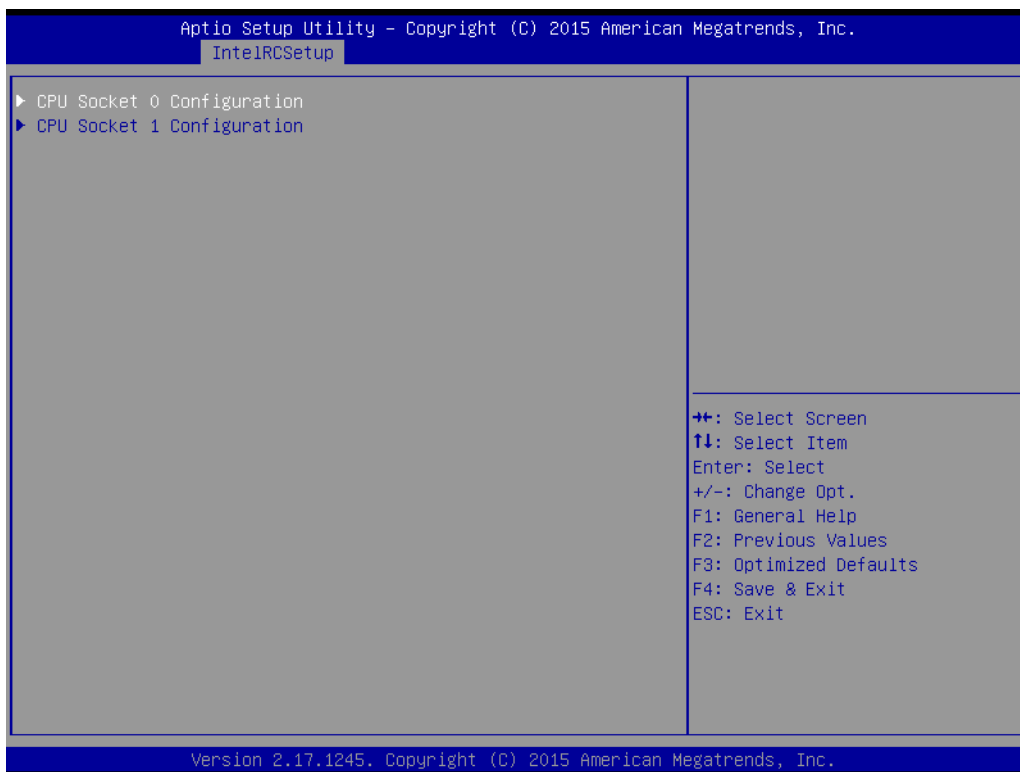

- **Hyper-threading**
Enables Hyper Threading (Software Method to Enable/Disable Logical Processor threads).
- **VMX**
Enables the Vanderpool Technology, takes effect after reboot.

- **Enable SMX**
Enables Safer Mode Extensions.
- **Execute Disable Bit**
This item specifies the Execute Disable Bit Feature. The settings are Enabled and Disabled. The Optimal and Fail-Safe default setting is Enabled. If Disabled is selected, the BIOS forces the XD feature flag to always return to 0.
- **Hardware Prefetcher**
Hardware Prefetcher is a technique that fetches instructions and/or data from memory into the CPU cache memory well before the CPU needs it, so that it can improve the load-to-use latency. Set to enable or disable.
- **Adjacent Cache Line Prefetch**
The Adjacent Cache-Line Prefetch mechanism, like automatic hardware prefetch, operates without programmer intervention. When enabled through the BIOS, two 64- byte cache lines are fetched into a 128-byte sector, regardless of whether the additional cache line has been requested or not. Set to enable or disable.
- **DCU Streamer Prefetch**
Enable prefetch of next L1 data line based upon multiple loads in same cache line.
- **DCU IP Prefetcher**
Enable prefetch of next L1 line based upon sequential load history.
- **DCU Mode**
MSR 31h Bit[0] - A write of 1 selects the DCU mode as 16KB 4-way with ECC.
- **AES-NI**
Enable/disable AES-NI support.

3.2.3.2 Advanced Power Management Configuration

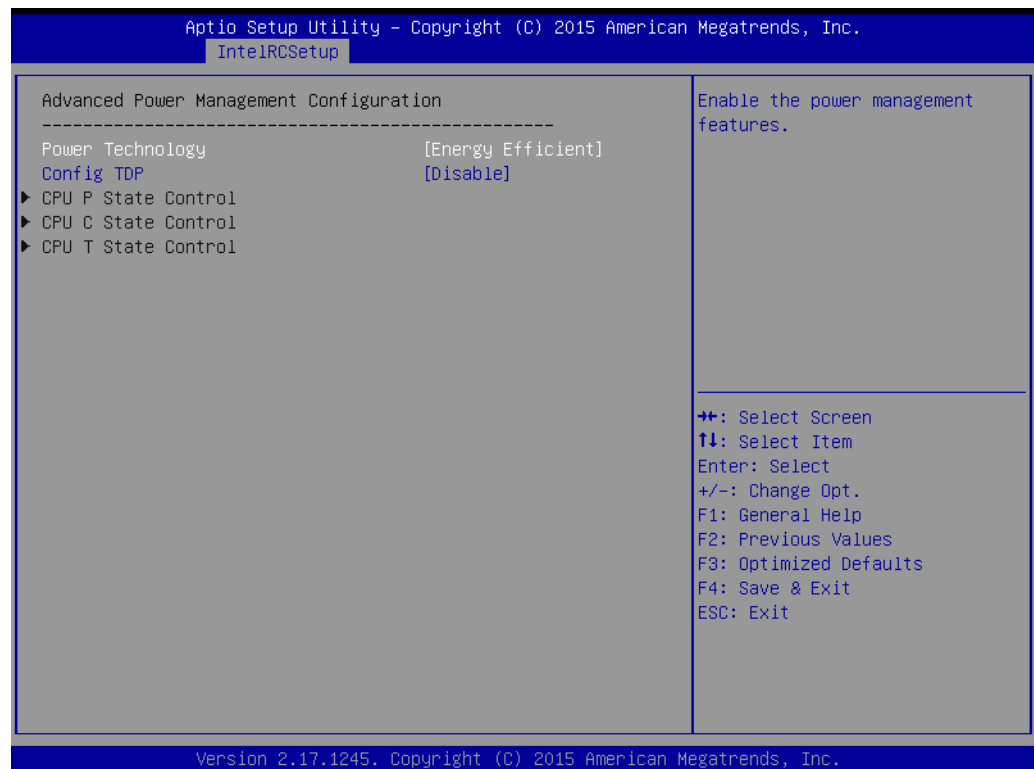

Power technology default is “Energy Efficient”.

- **Config TDP**
Option to disable/enable config TDP.

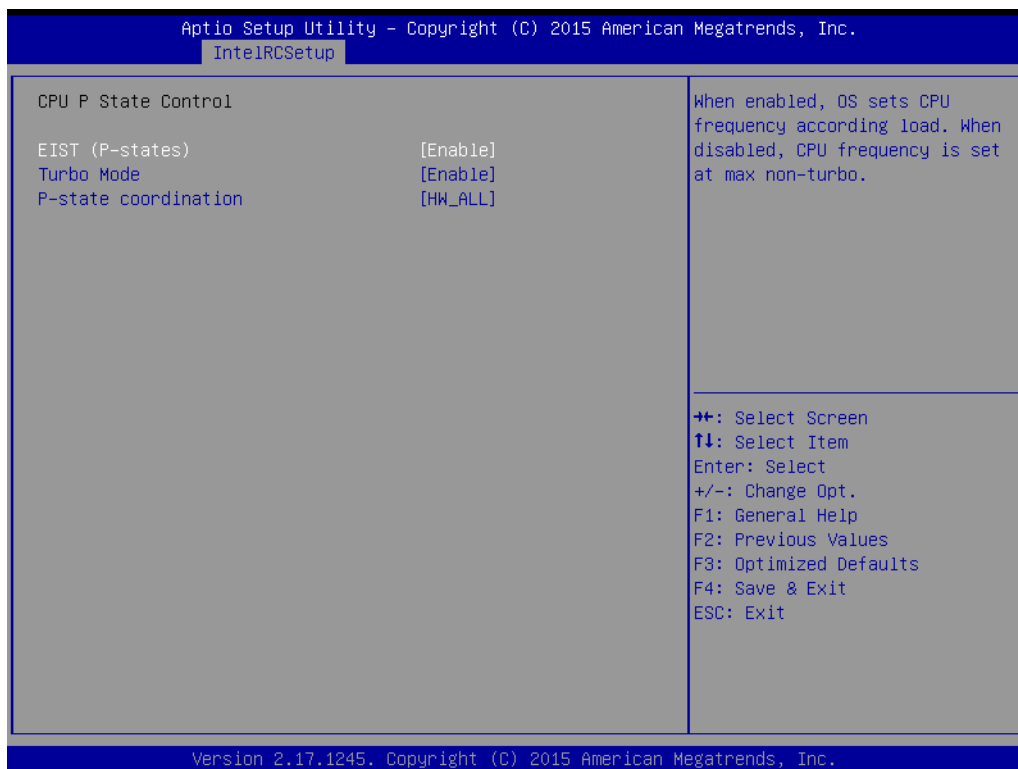

- **EIST (P-states)**
When enabled, OS sets CPU frequency according load. When disabled, CPU frequency is set at max non-turbo.
- **Turbo Mode**
Turbo mode allows a CPU logical processor to execute a higher frequency when enough power is available not exceed CPU defined limits.
- **P-state Coordination**
HW_ALL (hardware) coordination is recommended over SW_ALL and SW_ANY (software coordination).

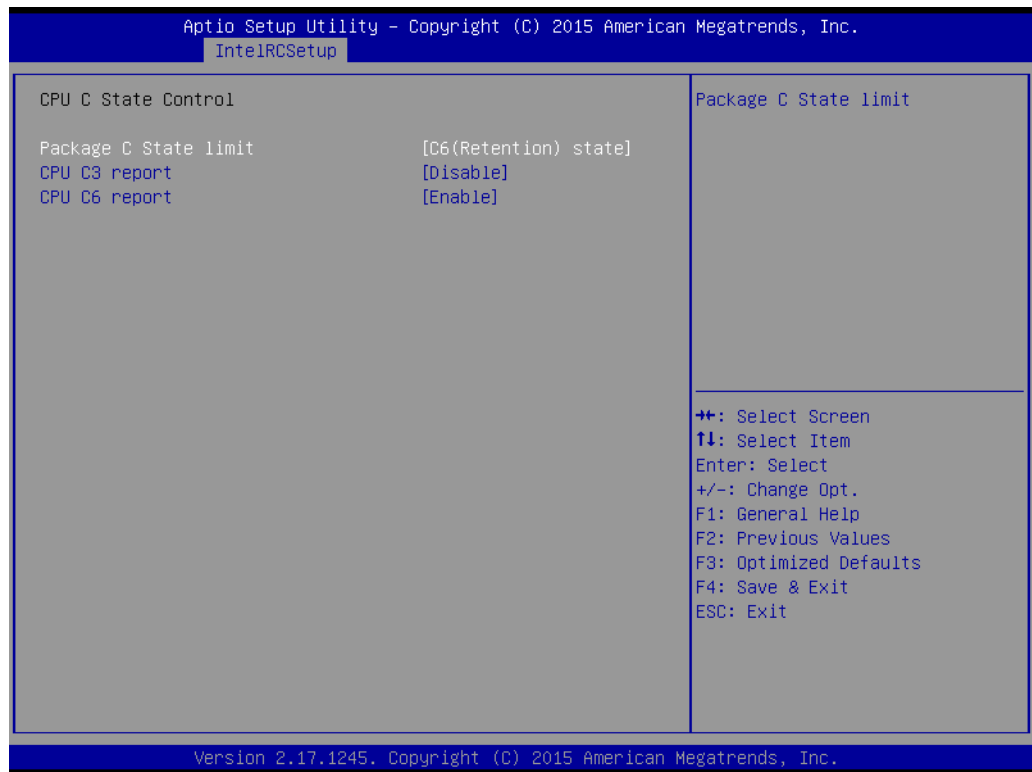

- **Package C State limit**
There are four items for option, "C0/C1 state", "C2 state", "C6 (non Retention) state", "C6 (Retention) state".
- **CPU C3 report**
Enable/Disable CPU C3(ACPI C2) report to OS. Recommended to be disabled.
- **CPU C6 report**
Enable/Disable CPU C6(ACPI C2) report to OS. Recommended to be enabled.

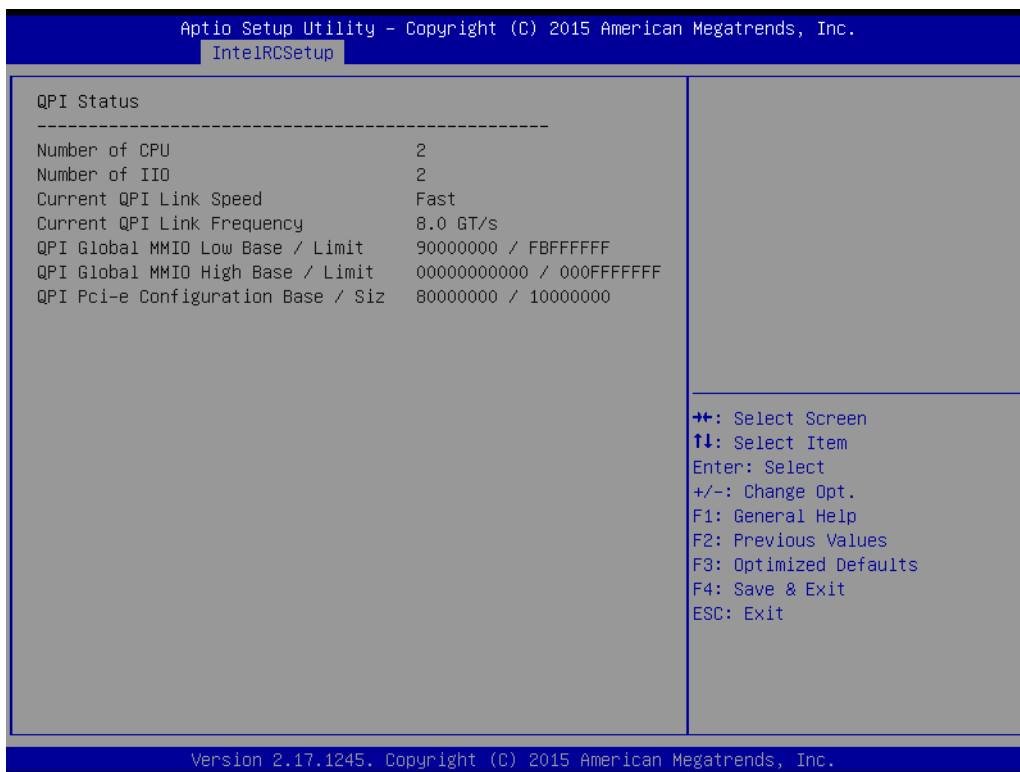

- **ACPIT-States**
Enable/Disable CPU throttling by OS. Throttling reduces power consumption.

3.2.3.3 QPI Configuration

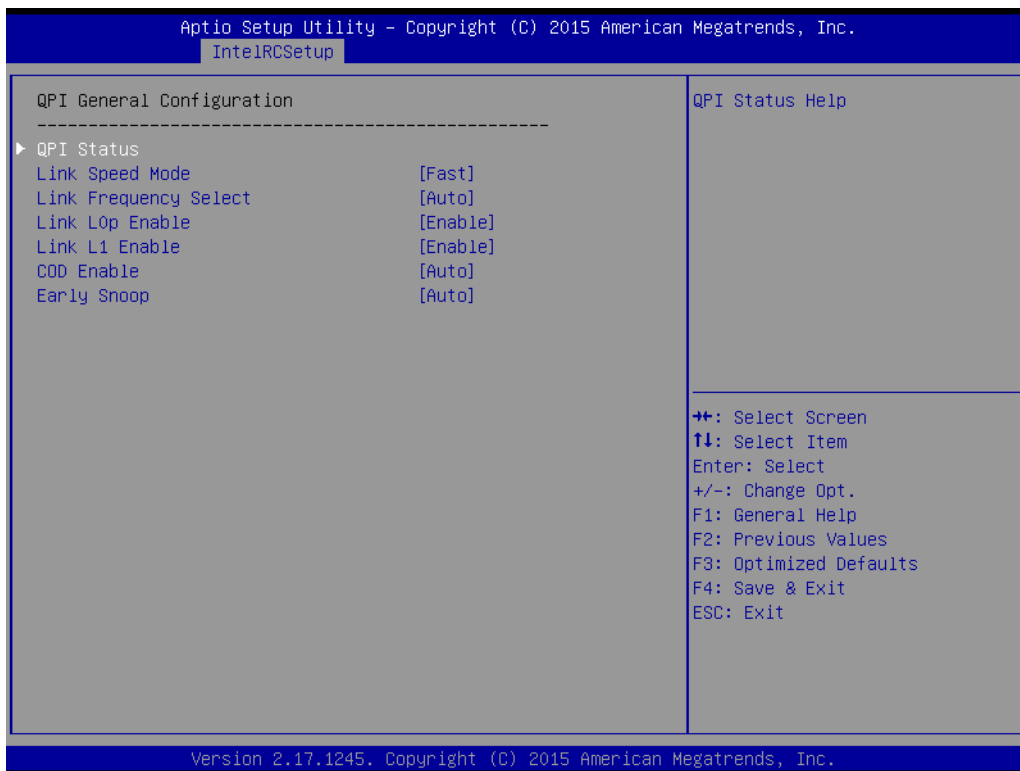

– QPI status

```
Aptio Setup Utility - Copyright (C) 2015 American Megatrends, Inc.
IntelRCSetup

QPI Status
-----
Number of CPU                2
Number of IIO                2
Current QPI Link Speed       Fast
Current QPI Link Frequency   8.0 GT/s
QPI Global MMIO Low Base / Limit  90000000 / FBFFFFFFF
QPI Global MMIO High Base / Limit 00000000000 / 000FFFFFFF
QPI Pci-e Configuration Base / Siz 80000000 / 10000000

++: Select Screen
↑↓: Select Item
Enter: Select
+/-: Change Opt.
F1: General Help
F2: Previous Values
F3: Optimized Defaults
F4: Save & Exit
ESC: Exit

Version 2.17.1245. Copyright (C) 2015 American Megatrends, Inc.
```

– Link Speed Mode

Select the QPI link speed as either the POR speed (Fast) or default speed (Slow).

– Link Frequency Select

Allows for selecting the QPI Link frequency.

– Link L0p Enable

Enable/Disable QPI Link0p.

– Link L1 Enable

Enable/Disable QPI L1.

– COD Enable

Enable/Disable Cluster on Die.

– Early snoop

Enable/Disable/Auto the early snoop item.

3.2.3.4 Memory Configuration

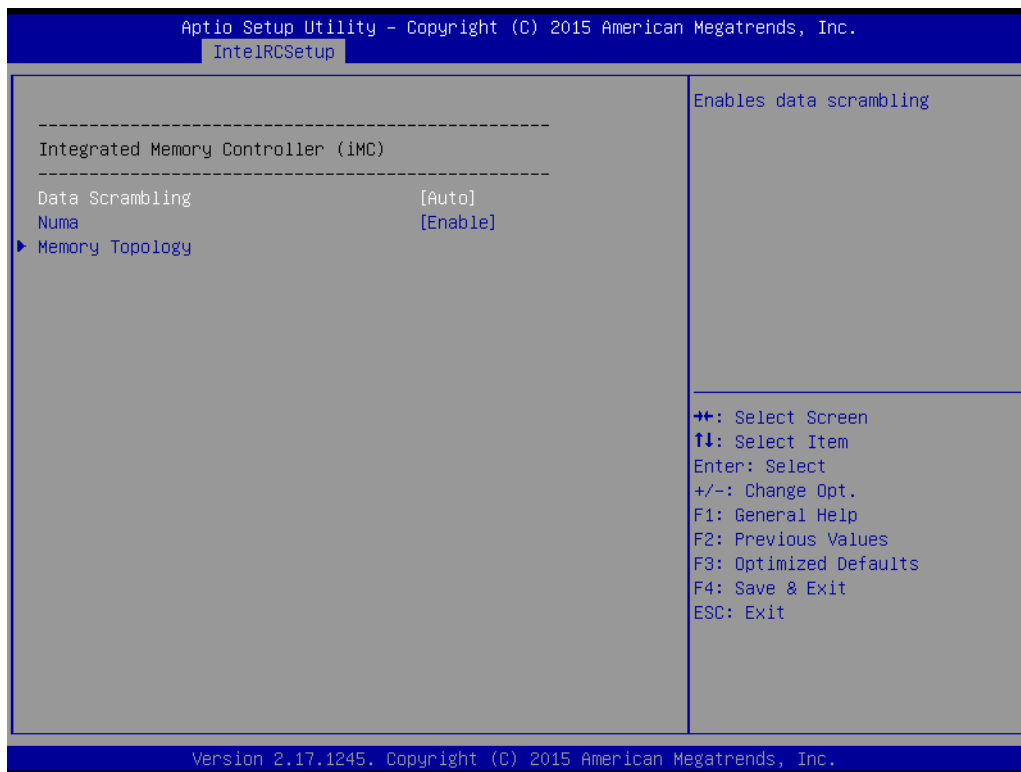

- **Data Scrambling**
Enable/Disable data scrambling.
- **Numa**
Enable/Disable Non-uniform Memory Access (NUMA).
- **Memory Topology**

3.2.3.5 IIO Configuration

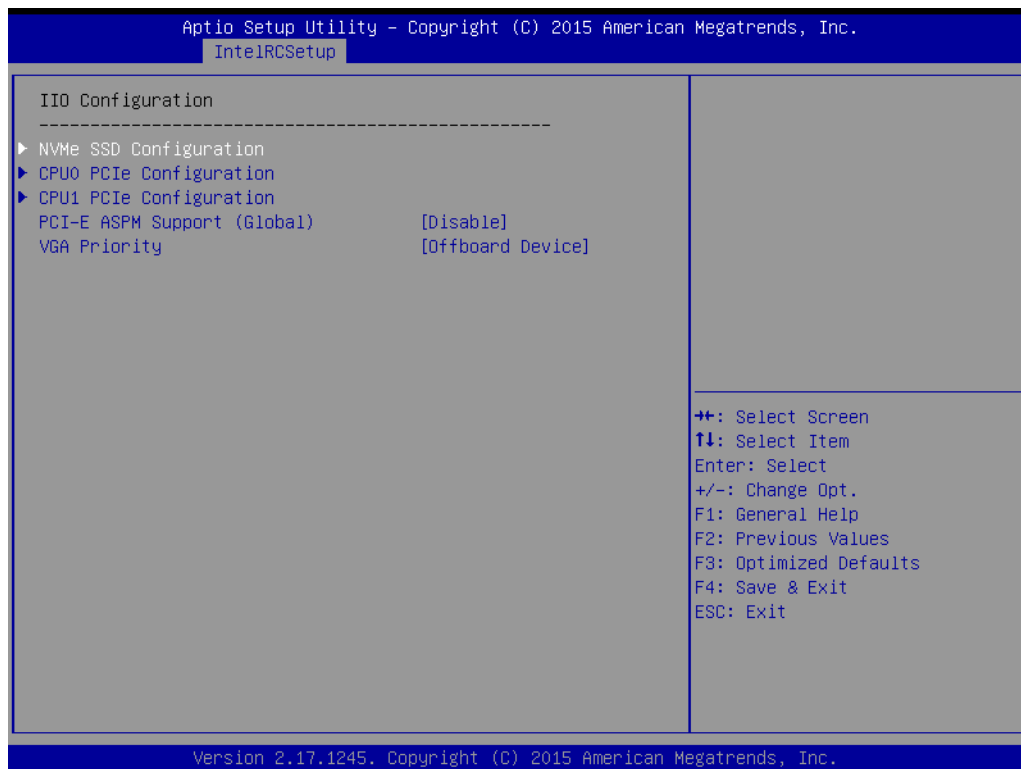

NVMe SSD Configuration

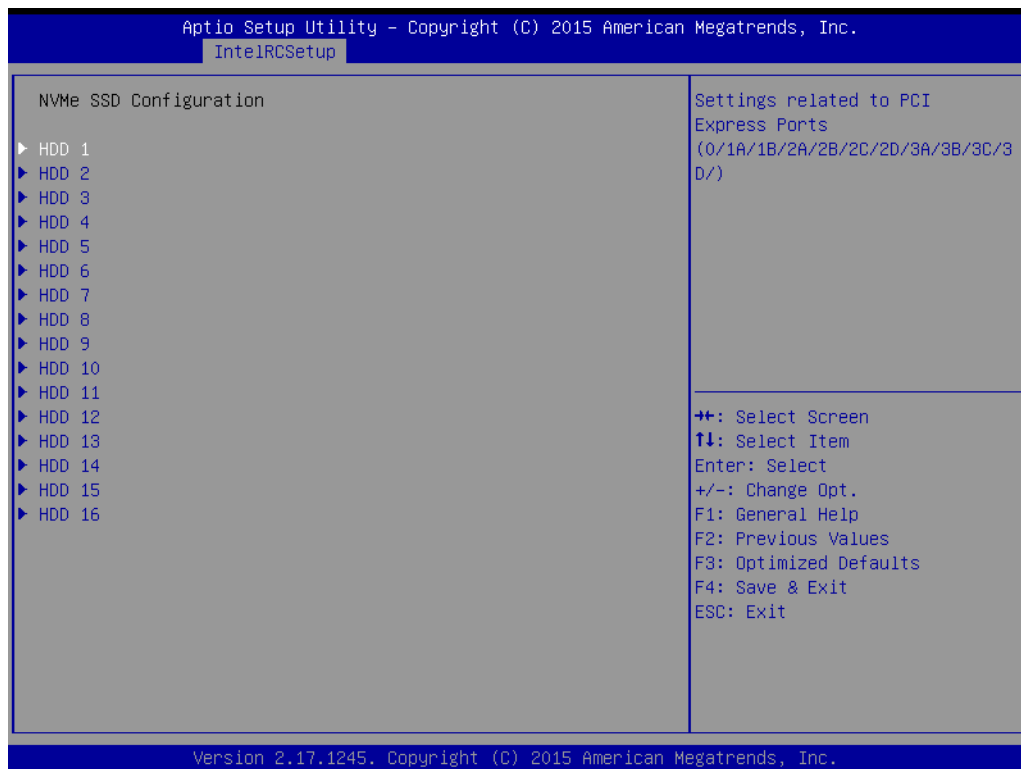

- **NVMe SSD Configuration for HDD1 to HDD16**
To set each NVMe drive PCIe link as [Auto]/[Gen1]/ [Gen2]/ [Gen3]

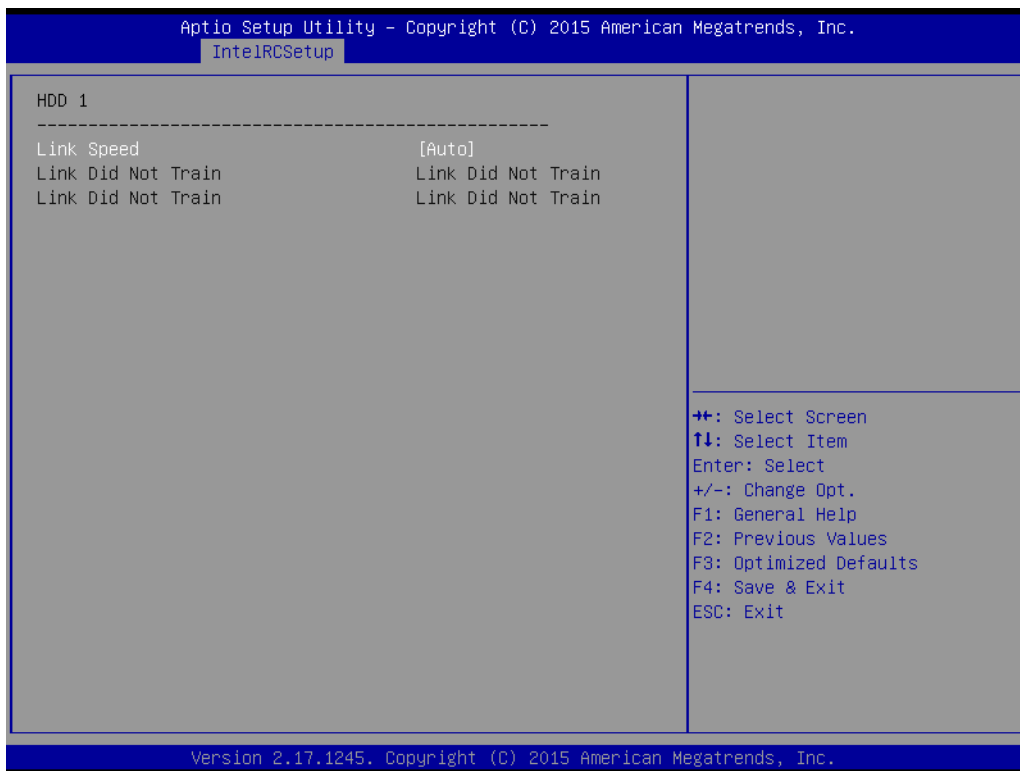

CPU0 PCIe Configuration

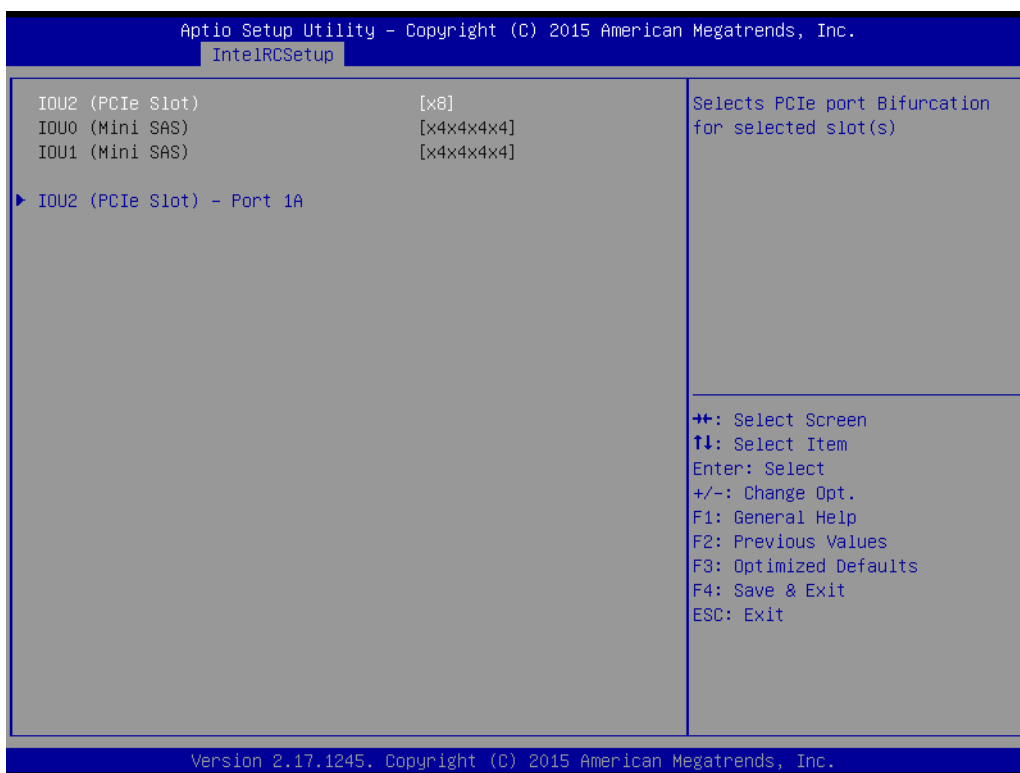

- **CPU0 PCIe configuration**
 - **IOU2 (PCIe Slot)**
Functions visible based on this setting:
x4x4
x8

- **CPU1 PCIe configuration**
 - **IOU2 (PCIe Slot4)**
Functions visible based on this setting:
x4x4
x8

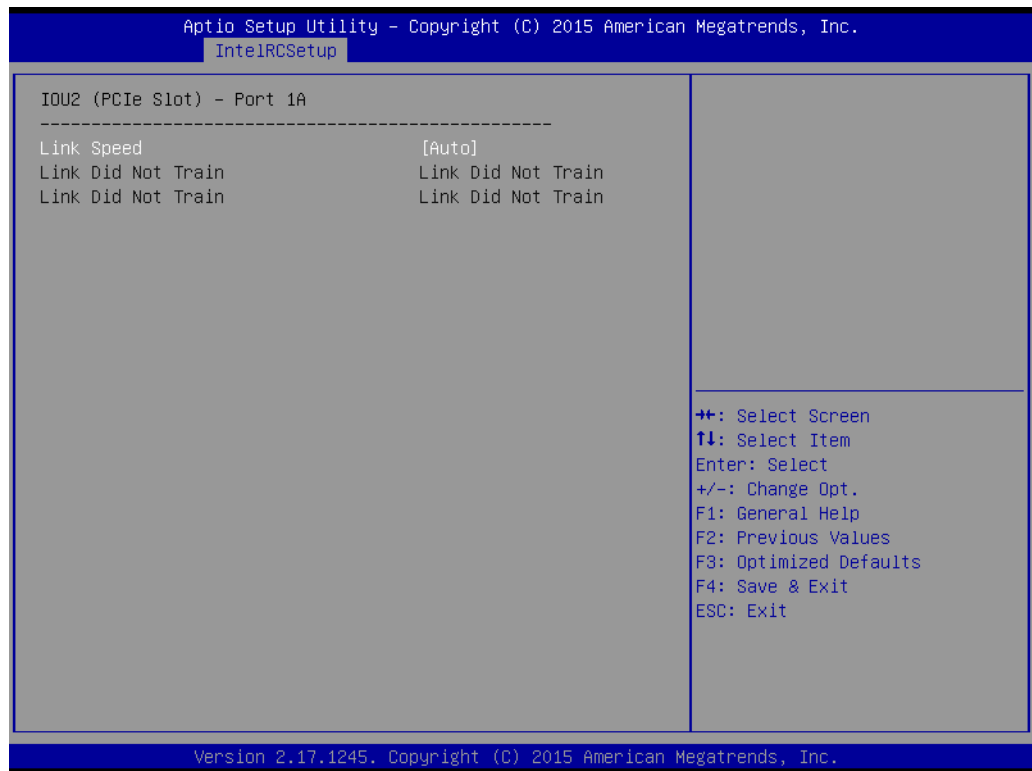

- **Link Speed of IOU2 (PCIe Slot) - Port 1A**
Select target link speed as Gen1, Gen2, Gen3.

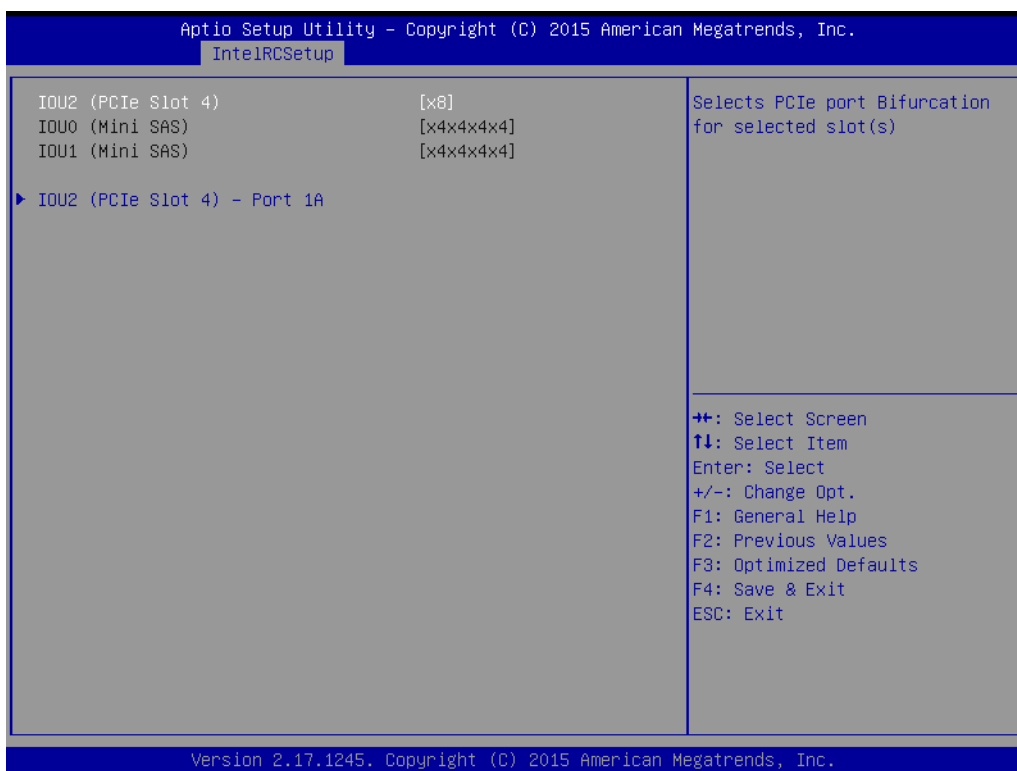

- **CPU1 PCIe configuration**
 - **IOU2 (PCIe Slot4)**
Functions visible based on this setting:
x4x4
x8



- **Link Speed of IOU2 (PCIe Slot 4) -Port 1A**
Select target link speed as Gen1, Gen2, Gen3.

3.2.3.6 PCH Configuration

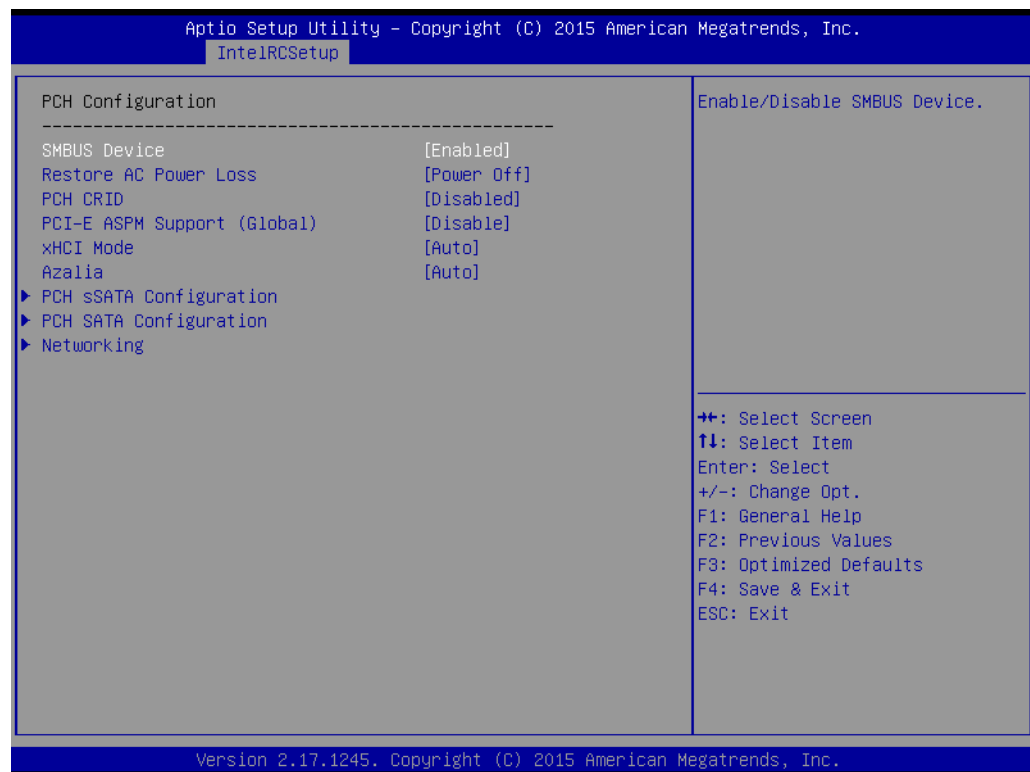

- **SMBus Device**
Enable/Disable SMBus Device.
- **Restore AC Power Loss**
Specify what state to go to when power is re-applied after a power failure (G3 state).
- **PCH Compatibility RID**
Enable/Disable PCH Compatibility Revision ID (CRID) Functionality.
- **PCI-E ASPM Support (Global)**
This option enables/disables the ASPM support for all downstream devices.
- **xHCI Mode**
Mode of operation of xHCI controller.

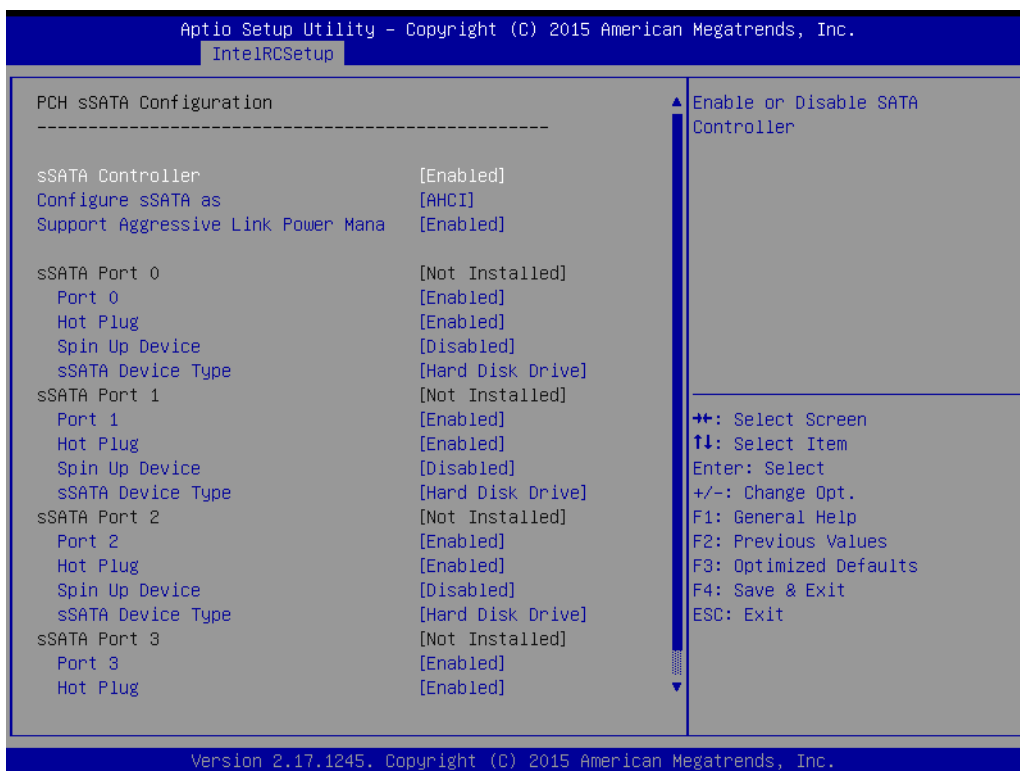

- **sSATA Controller**
Enables/Disables sSATA controller.
- **Configure sSATA as**
Configured as IDE/RAID/AHCI mode.
- **Supports Aggressive Link Power Management**
Enables/Disables SALP, and this item will appear when "AHCI" or "RAID" is selected.
- **sSATA Device Type**
Identify the SATA port is connected to Solid State Drive or Hard Disk Drive. Set to "AHCI Mode" to have the SATA hard disk drives use the AHCI (Advanced Host Controller Interface). The AHCI allows the onboard storage driver to enable advanced Serial ATA features that increase storage performance on random workloads by allowing the drive to internally optimize the order of commands.

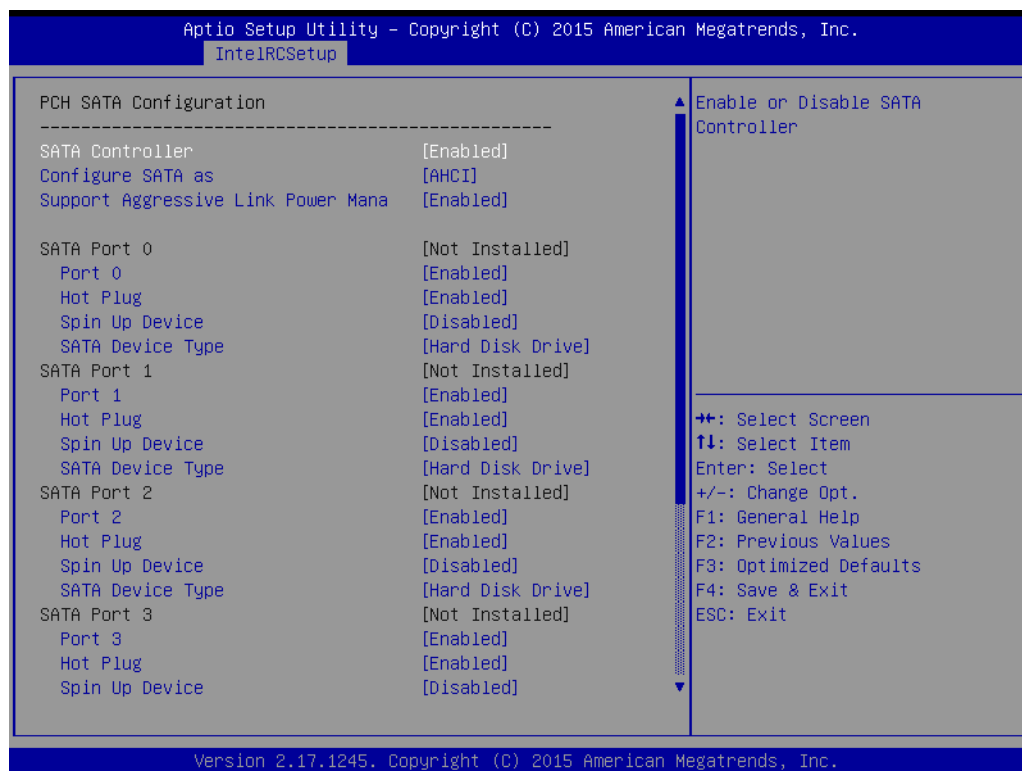

Set to "RAID Mode" to create a RAID configuration from the SATA hard disk drives.

- **SATA Controller**
Enables/Disables sSATA controller.
- **Configure SATA as**
Configured as IDE/RAID/AHCI mode.
- **Supports Aggressive Link Power Management**
Enables/Disables SALP, and this item will appear when "AHCI" or "RAID" is selected.
- **SATA Device Type**
Identify the SATA port is connected to Solid State Drives or Hard Disk Drives. Set to "AHCI Mode" to have the SATA hard disk drives use the AHCI (Advanced Host Controller Interface). The AHCI allows the onboard storage driver to enable advanced Serial ATA features that increase storage performance on random workloads by allowing the drive to internally optimize the order of commands.

Set to "RAID Mode" to create a RAID configuration from the SATA hard disk drives.

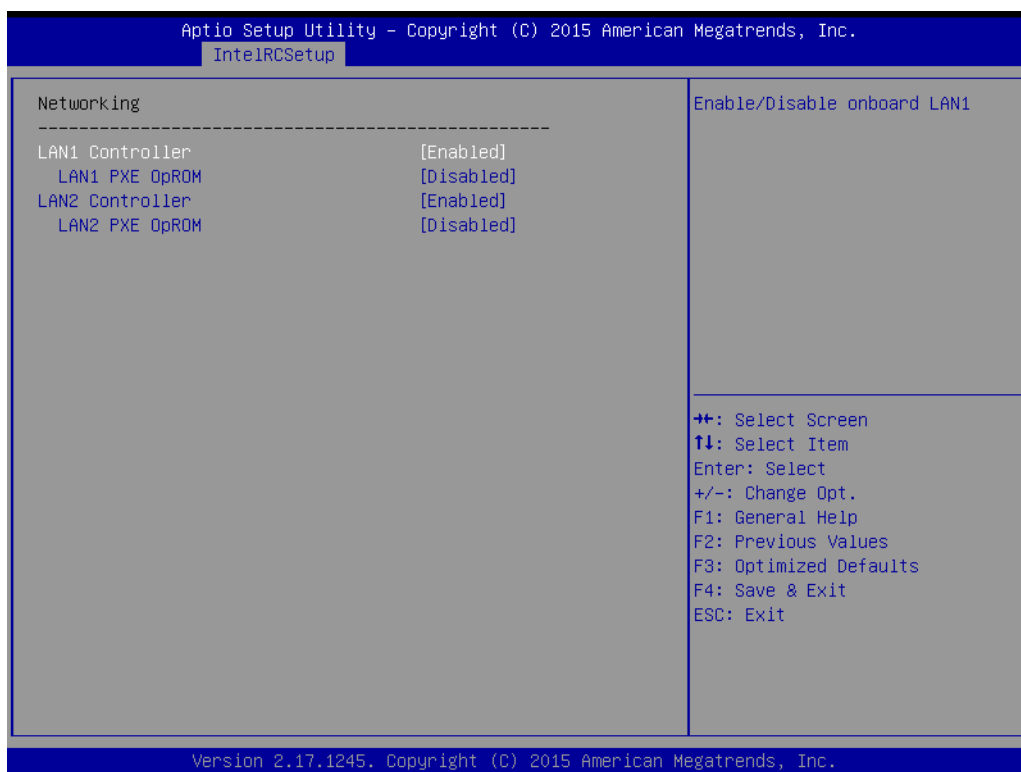

- **LAN1 Controller**
Enable/Disable Intel I210AT Controller support.
- **LAN1 PXE Oprom**
Enable/Disable Boot option for Intel I210AT controller.
- **LAN2 Controller**
Enable/Disable Intel I210AT Controller support.
- **LAN2 PXE OpROM**
Enable/Disable Boot option for Intel I210AT controller.

3.2.3.7 Server ME Configuration

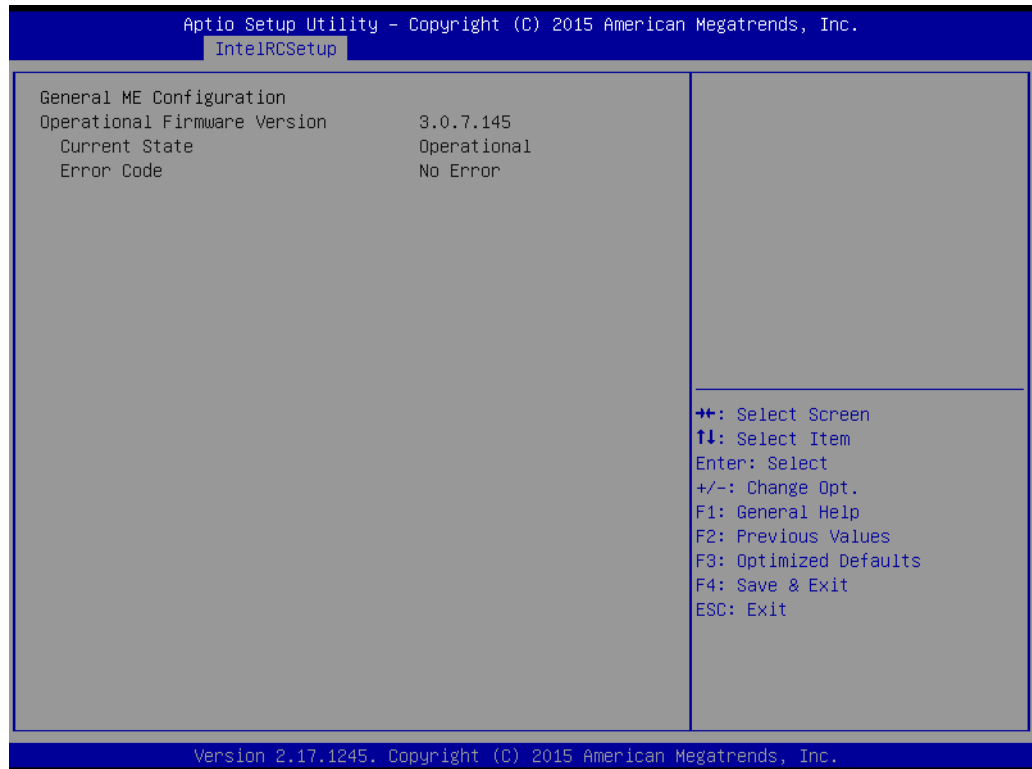

3.2.4 Server Management

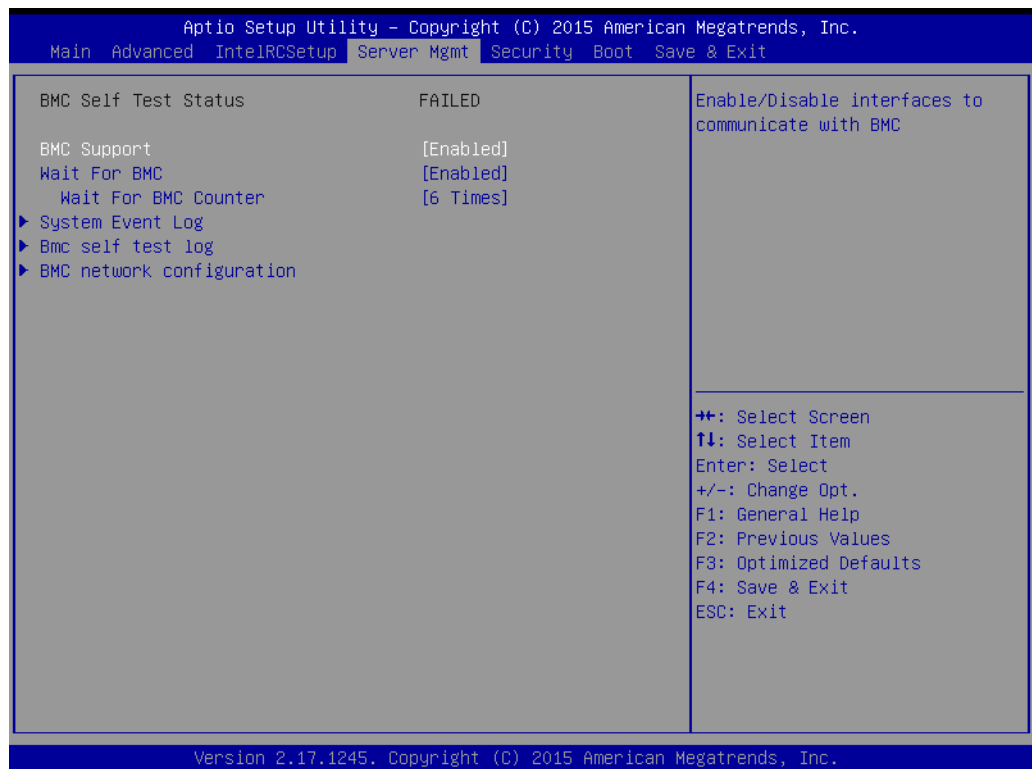

- **BMC Support**
Enable/Disables interfaces to communicate with BMC
- **Wait for BMC**

If enabled, the motherboard will wait 30 ~ 60 seconds until BMC module boots up completely. After that, the normal BIOS post screen will be displayed.

If disabled, the motherboard will not wait for BMC module's response.

- **Wait for BMC counter**

Wait for BMC counter for initialize host to BMC interfaces.

The MB beep per 5 seconds to check it.

- **System Event Log**

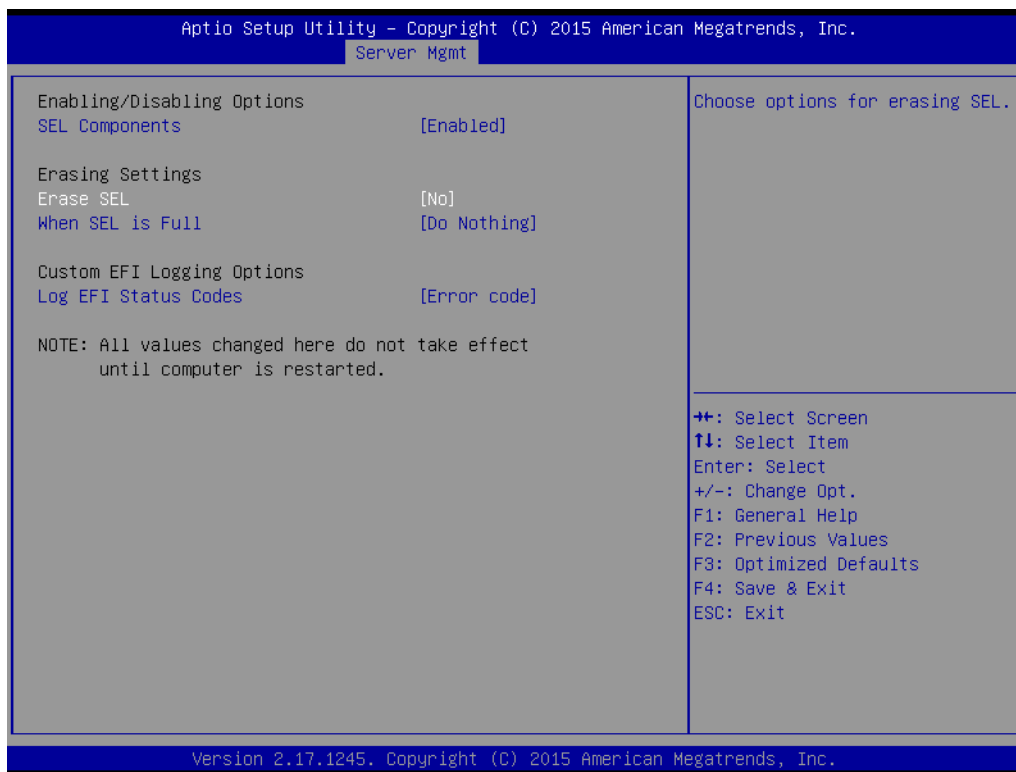

- **SEL Components**

Enable/Disable all features of system event logging during boot.

- **Erase SEL**

Choose options for erasing SEL.

- **When SEL is Full**

Choose options for reactions to a full SEL.

- **Log EFI Status Codes**

Disable the logging of EFI status codes or log only error code or only progress code or both.

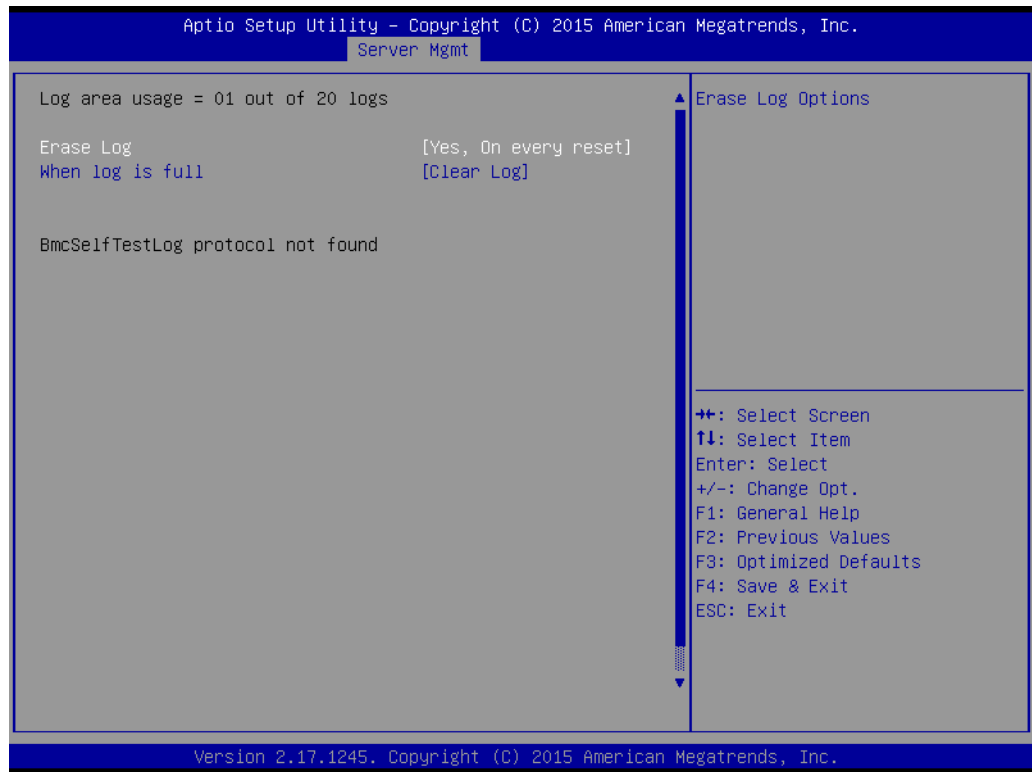

- **Erase Log**
Erase log options.
- **When Log is Full**
Selects the action to be taken when the log is full.

■ BMC Network Configuration

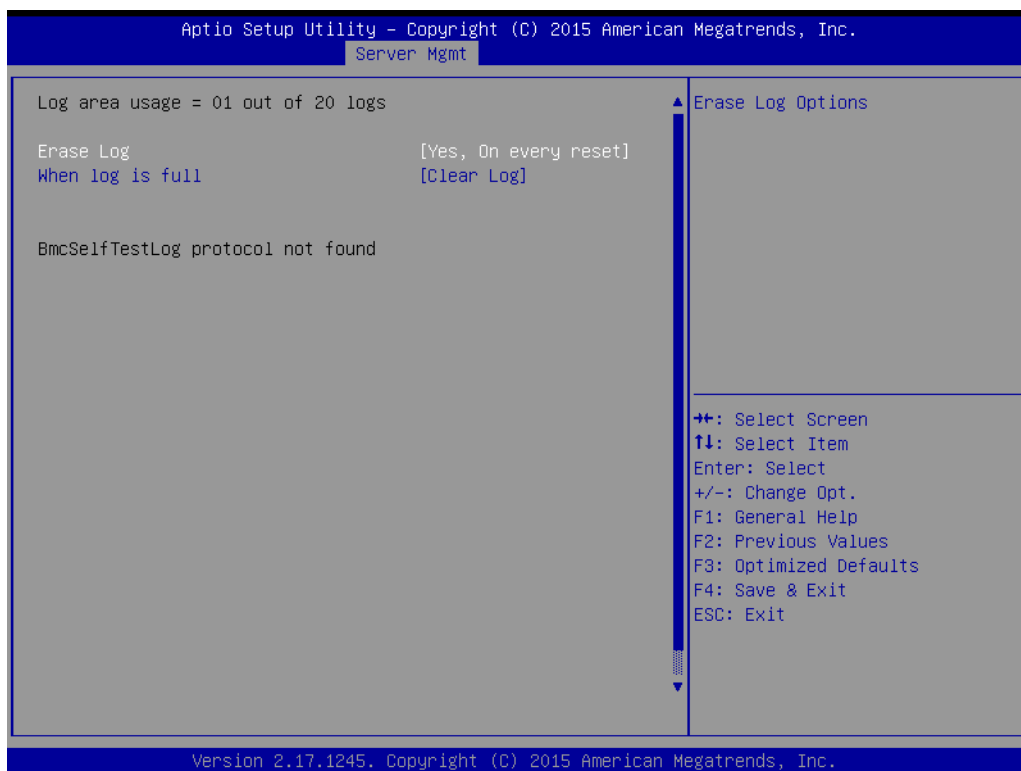

– Configuration Address Source

Select to configure LAN channel parameters statically or dynamically (by BMC). Unspecified options will not modify any BMC network parameters during the BIOS phase.

3.2.5 Security

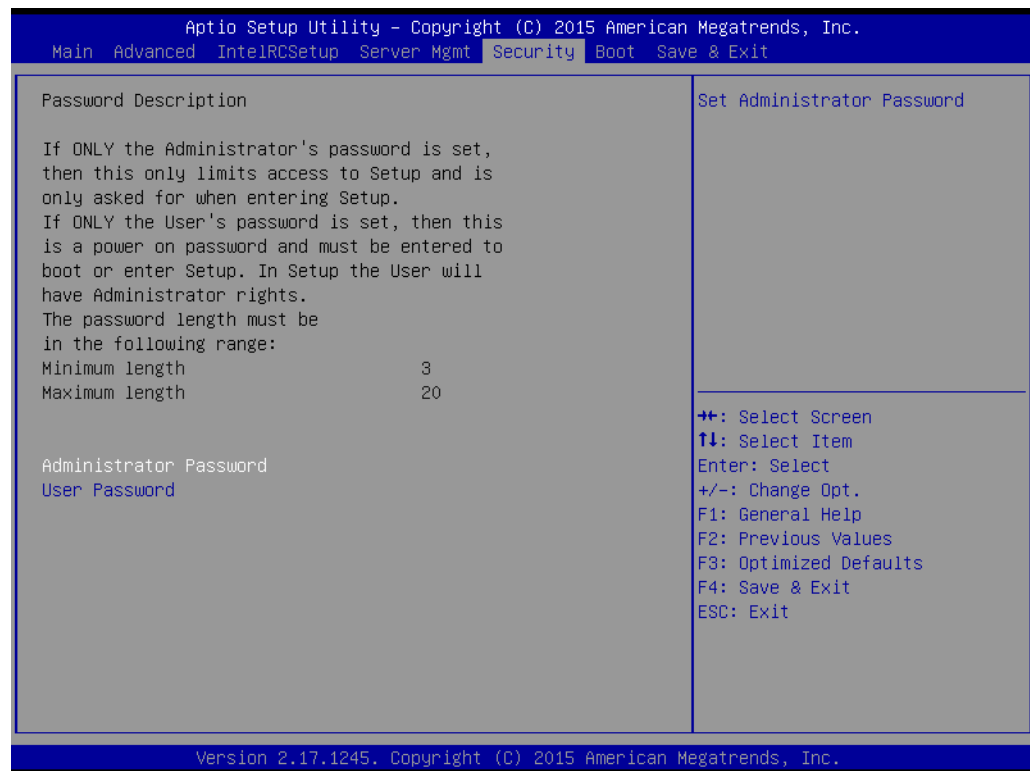

3.2.6 Boot



- **Setup Prompt Timeout**
Number of seconds to wait for setup activation key. 16 (0x10) means indefinite waiting.

- **Bootup NumLock State**
Select the keyboard NumLock state.
- **Quiet Boot**
Enable/Disable quiet boot option.
- **Boot Option**
Sets the system boot priorities.

3.2.7 Save & Exit



- **Save Changes and Exit**
Exit system setup after saving the changes.
- **Discard Changes and Exit**
Exit system setup without saving any changes.
- **Save Changes and Reset**
Reset the system after saving changes.
- **Discard Changes and Reset**
Reset system setup without saving any changes.
- **Save Changes**
Save changes done so far.
- **Discard Changes**
Discard changes done so far.
- **Restore Defaults**
Restore/Load default values for all the setup options.
- **Save as User Defaults**
Save the changes done so far as user defaults.
- **Restore User Defaults**
Restore the user defaults to all the user setup options.

Chapter 4

Chipset Software
Installation Utility

4.1 Before You Begin

To facilitate the installation of the enhanced display drivers and utility software, read the instructions in this chapter carefully. The drivers for the ASR-3100 are located on the software installation CD. Before beginning, it is important to note that most display drivers need to have the relevant software application already installed on the system prior to installing the enhanced display drivers. In addition, many of the installation procedures assume that you are familiar with both the relevant software applications and operating system commands. Review the relevant operating system commands and the pertinent sections of your application software's user manual before performing the installation.

4.2 Introduction

4.2.1 Main Menu

The Intel Chipset Software Installation (CSI) utility installs the Windows INF files that outline to the operating system how the chipset components will be configured. This is needed for the proper functioning of the following features:

- Core PCI PnP services
- Serial ATA interface support
- USB 1.1/2.0 support
- Identification of Intel chipset components in the Device Manager

Note! *The files on the software installation CD are compressed. Do not attempt to install the drivers by copying the files manually. You must use the supplied SETUP program to install the drivers.*



Note! *The chipset driver is used for the following versions of Windows, and it has to be installed before installing all the other drivers:*



<i>Windows Server 2012 R2 Standard</i>	<i>x64</i>
<i>Windows Server 2012 Standard</i>	<i>x64</i>
<i>Windows Server 2008 Enterprise Edition R2(SP1)</i>	<i>x64</i>
<i>Windows 8 Professional</i>	<i>x86 & x64</i>
<i>Windows 7(Ultimate SP1)</i>	<i>x86 & x64</i>

4.3 Windows OS Driver Setup

1. Insert the driver CD into your system's CD-ROM drive. When the folder is displayed, move the mouse cursor over the folder "01_Chipset". Find the executable in this folder, click to install the driver.

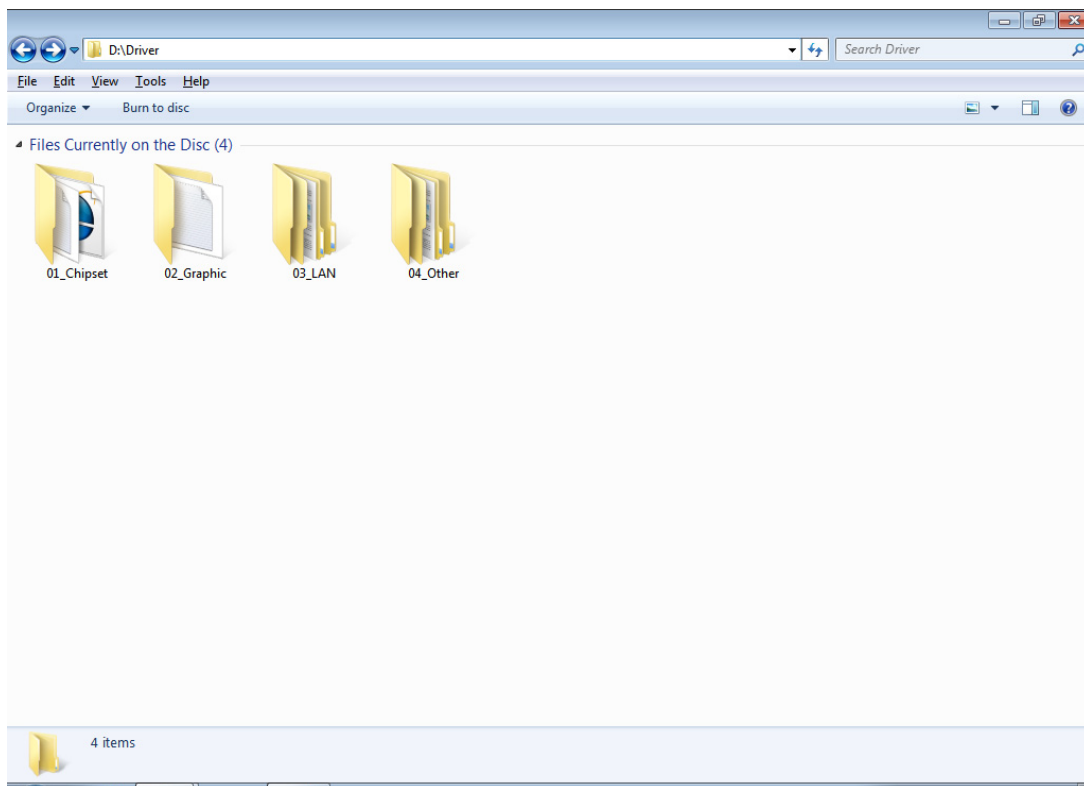

2. Click setup to execute program.

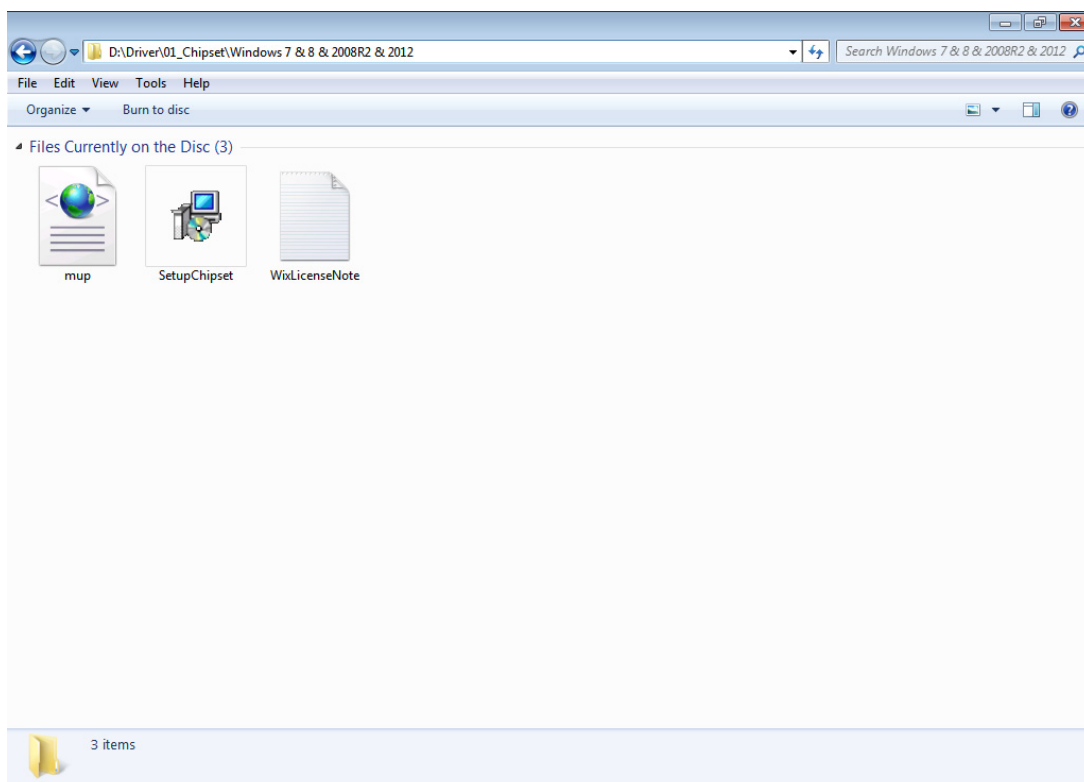

Chapter 5

VGA Setup

5.1 Introduction

Install the ASPEED VGA driver to enable this function, which includes the following features:

- 32-bit 2D graphics engine on board for normal use.
- 64 MB RAM for this chip, the highest resolution is 1920x1200.

5.2 Windows Series Driver Setup

Insert the driver CD into your system's CD-ROM drive. When the folder is displayed, navigate to the "02_Graphic" folder and click the executable file from folder of XDDM Installer/WDDM Installer to complete the installation of the drivers for OS that you need.

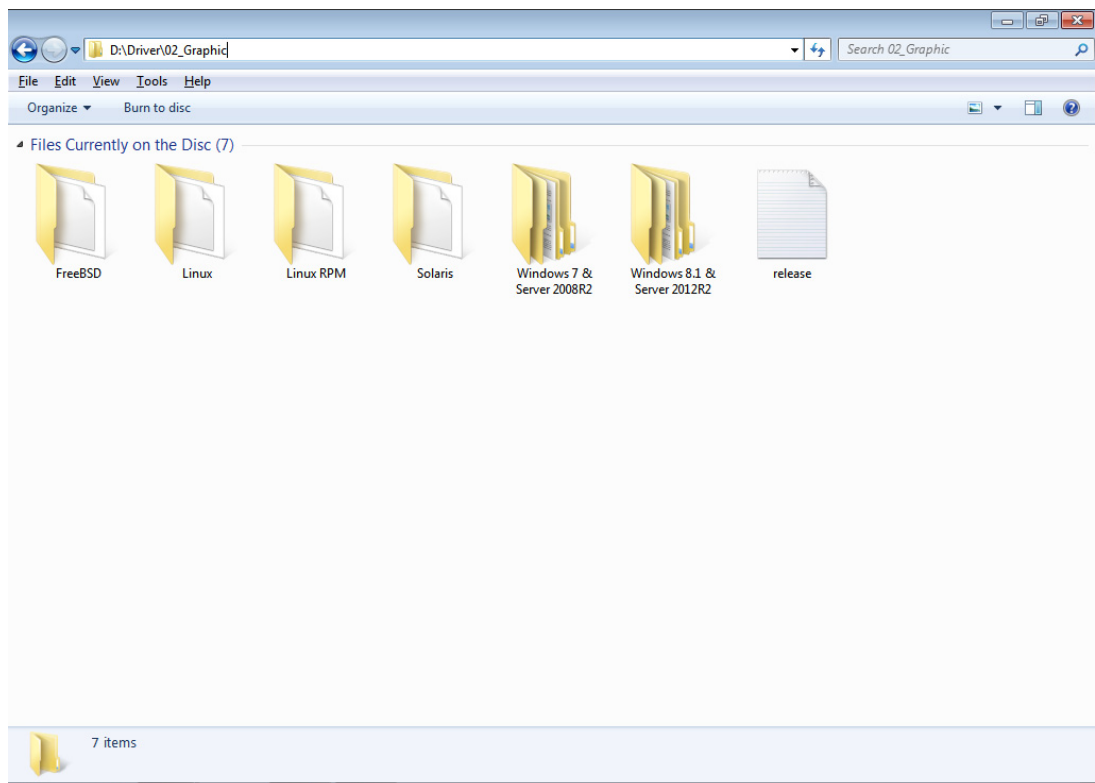

- Note!**
1. If ASR-3100 carries an additional graphics card for VGA output, please set this additional graphic card as "major output" under the "Display properties" of OS.
 2. Please use the driver file from "Windows WDDM" folder as first choice.

Chapter 6

LAN Configuration /
SATA RAID & AHCI /
USB 3.0 Setup

6.1 LAN Configuration

6.1.1 Introduction

The ASR-3100 has two Gigabit Ethernet LAN connections via dedicated PCI Express x1 lanes: LAN1(Intel I210AT)/LAN2(Intel I210AT). They offer bandwidth of up to 250 MB/sec, eliminating the bottleneck of network data flow and incorporating Gigabit Ethernet at 1000 Mbps.

6.1.2 Features

- 10/100/1000Base-T Ethernet controller
- 10/100/1000Base-T triple-speed MAC
- Full duplex at 10, 100, or 1000 Mbps and half duplex at 10 or 100 Mbps
- Wake-on-LAN (WOL) support
- PCIe x1 host interface

6.1.3 Installation

The integrated Intel gigabit Ethernet controller supports all major network operating systems. However, the installation procedure varies with different operating systems. In the following sections, refer to the one that provides the driver setup procedure for the operating system you are using.

6.1.4 Windows Series Driver Setup (LAN)

1. Insert the driver CD into your system's CD-ROM drive. Select folder "03_Lan chip" then click the proper Lan driver for the OS.

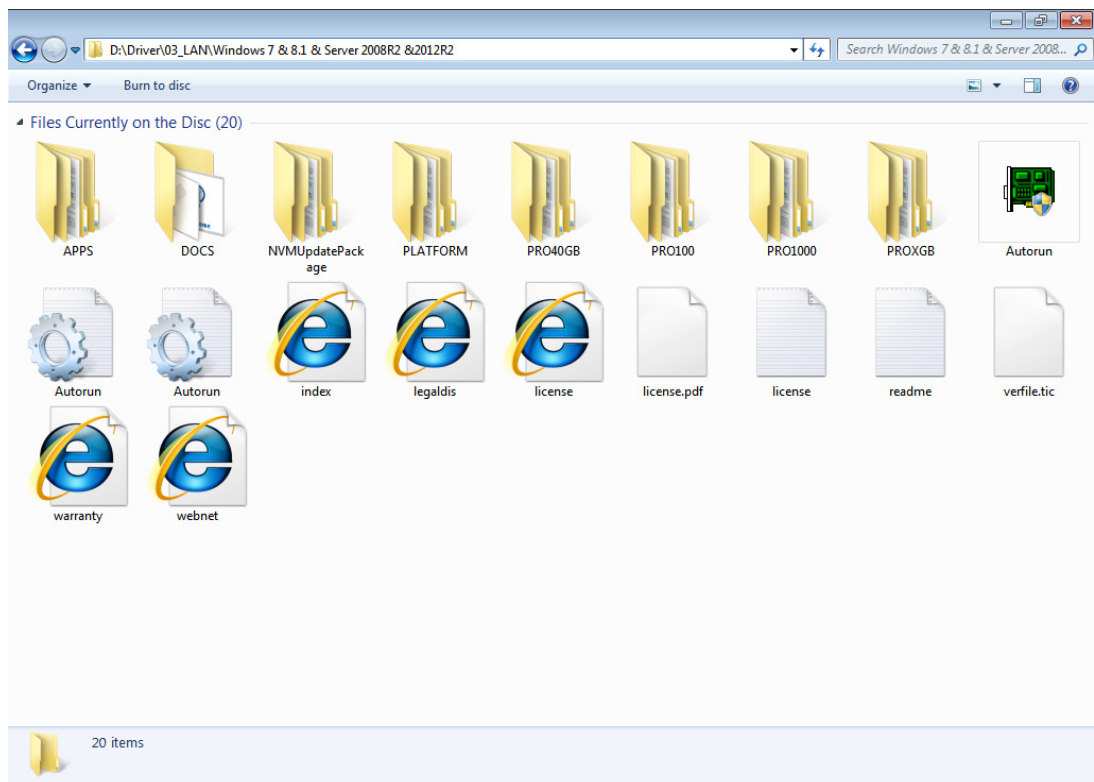

6.2 AHCI & SATA RAID

Intel C612 PCH chip offers SATA RAID with RAID 0, 1, 10, 5 under Windows operating system.

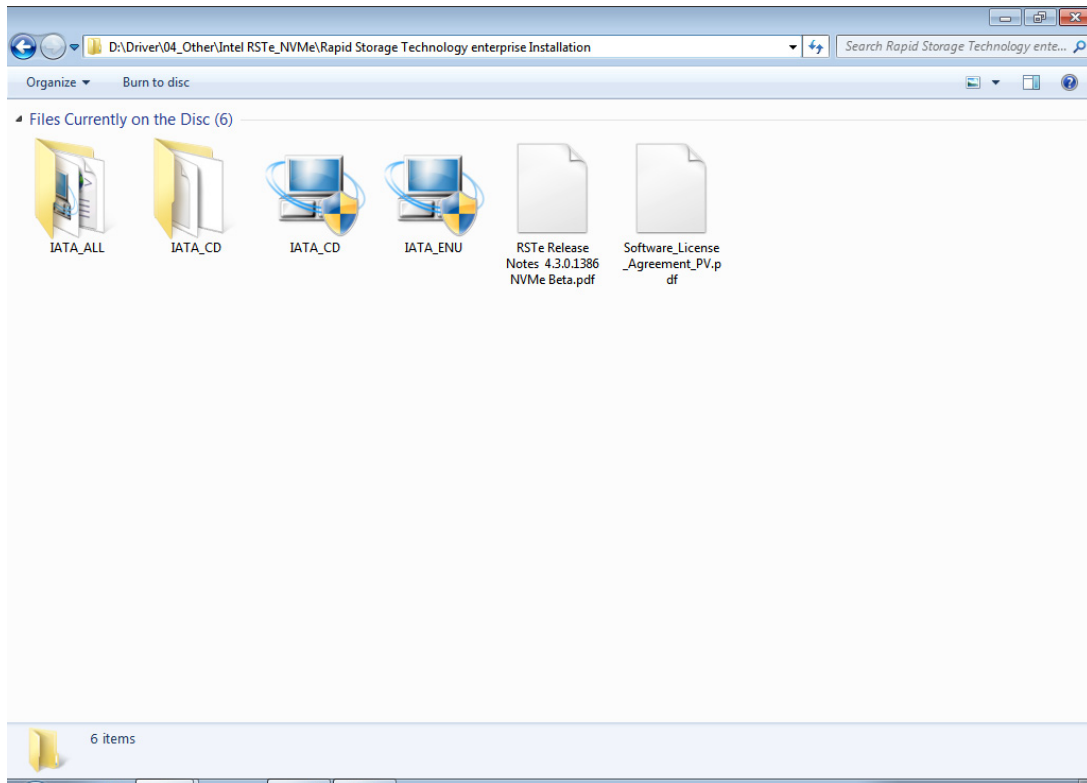

6.3 USB3.0

Intel C612 PCH chip offers USB3.0 controller for super-speed device access.

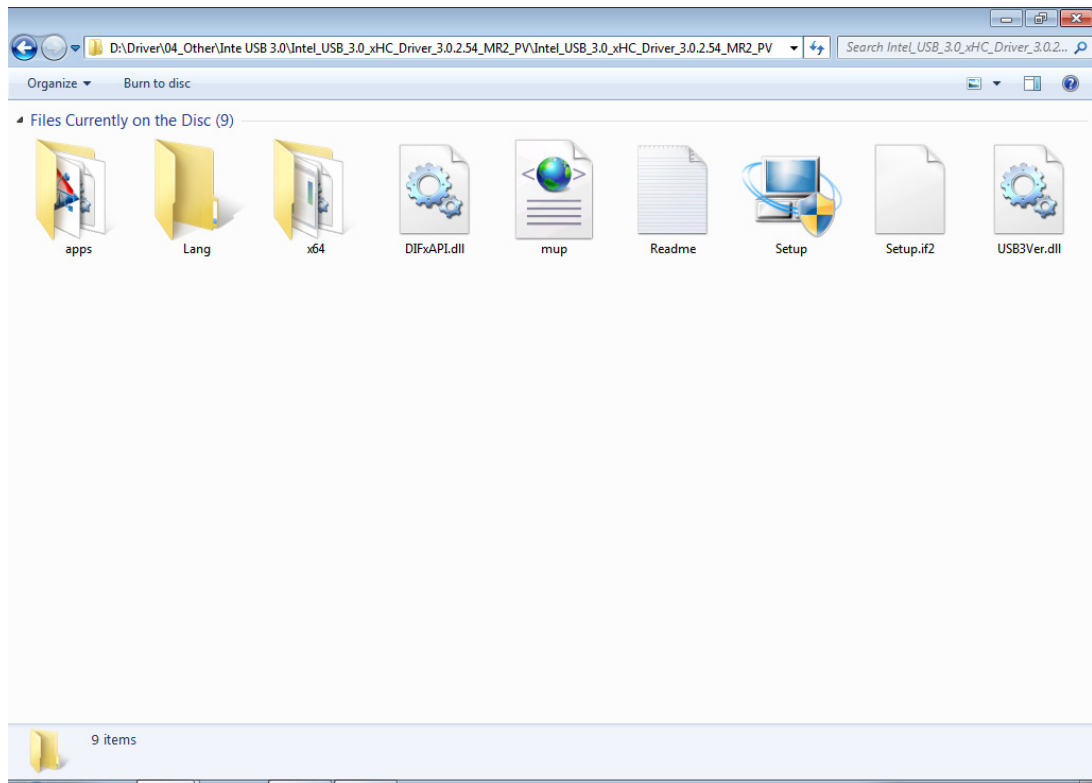

Appendix **A**

Programming the
Watchdog Timer

The ASR-3100's watchdog timer can be used to monitor system software operation and take corrective action if the software fails to function within the programmed period. This section describes the operation of the watchdog timer and how to program it.

A.1 Watchdog Timer Overview

The watchdog timer is built in to the hardware monitor NCT7902. It provides the following functions for user programming:

- Can be enabled and disabled by user program
- Timer can be set from 1 to 255 seconds or 1 to 255 minutes
- Generates an interrupt or resets signal if the software fails to reset the timer before time-out

A.2 Programming the Watchdog Timer

The Watch Dog timer programming steps as below:

1. Set Bank0 CR[E1h] Bit0 to 1 to enable Soft Watch Dog.
2. Set Bank0 CR[E3h] Timeout timer for Soft Watch Dog.
3. Set Bank0 CR[E0h] to 55h to enable Soft Watch Dog Timer. Set to AAh will disable Soft Watch Dog Timer.
4. The Soft Watch Dog will start count down.
5. When the timer that we set to CR[E3h] is timeout , WDTRST# will issue low pulse signal.
6. The Bank0 CR[E2h] is Watch Dog Status Register for reading.

ADVANTECH

Enabling an Intelligent Planet

www.advantech.com

Please verify specifications before quoting. This guide is intended for reference purposes only.

All product specifications are subject to change without notice.

No part of this publication may be reproduced in any form or by any means, electronic, photocopying, recording or otherwise, without prior written permission of the publisher.

All brand and product names are trademarks or registered trademarks of their respective companies.

© Advantech Co., Ltd. 2016