



MTA 100

TE Internal #: 3-640443-4

Standard Rectangular Connectors, Connector Assembly, Receptacle, Mating Retention, Insulation Displacement (IDC), Wire-to-Board, Tin, Normal, MTA 100

[View on TE.com >](#)

Connectors > Rectangular Connectors > Standard Rectangular Connectors > MTA Receptacle: Nylon, Tin Plated, 2.54 mm

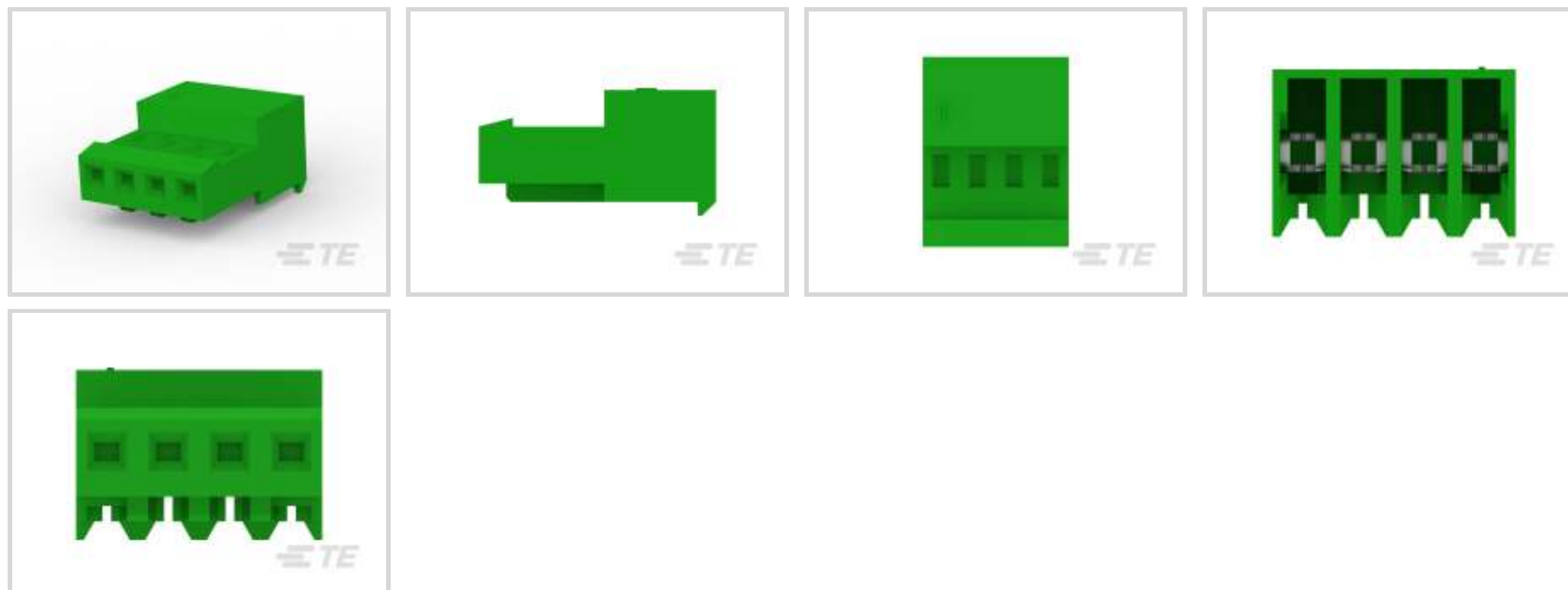

Connector Product Type: **Connector Assembly**

Connector & Housing Type: **Receptacle**

Mating Alignment: **Without**

Mating Retention: **With**

Mating Retention Type: **Locking Ramp**

[All MTA Receptacle: Nylon, Tin Plated, 2.54 mm \(167\)](#)

Features

Product Type Features

Compatible With Discrete Wire Type	Stranded
Connector Product Type	Connector Assembly
Connector & Housing Type	Receptacle
Connector System	Wire-to-Board
Insertion Force Type	Normal
Sealable	No
Connector & Contact Terminates To	Wire & Cable

Configuration Features

Number of Cavities	4
Contacts Preloaded	Yes
Number of Positions	4
Number of Rows	1



Electrical Characteristics

Operating Voltage	250 VAC
-------------------	---------

Contact Features

Contact Type	Receptacle
Wire Contact Termination Area Plating Material	Tin
Contact Underplating Material	Nickel
Contact Mating Area Plating Material	Tin
Contact Retention Within Housing	With
Contact Current Rating (Max)	5 A

Termination Features

Termination Method to Wire & Cable	Insulation Displacement (IDC)
------------------------------------	-------------------------------

Mechanical Attachment

Contact Retention Type Within Housing	Locking Lance
Mating Alignment	Without
Mating Retention	With
Mating Retention Type	Locking Ramp
Connector Mounting Type	Cable Mount (Free-Hanging)

Housing Features

Housing Material	Nylon 6/6
Housing Color	Green
Centerline (Pitch)	2.54 mm[.1 in]

Dimensions

Connector Height	13.21 mm[.52 in]
Product Width	6.99 mm[.275 in]
Product Length	10.16 mm[.4 in]
Wire Size	.08 – .09 mm ²

Usage Conditions

Operating Temperature Range	-55 – 105 °C[-67 – 221 °F]
-----------------------------	----------------------------

Operation/Application

Shielded	No
Circuit Application	Signal

Industry Standards



CSA Rating	LR 7189
UL Rating	Recognized
Agency/Standard	CSA, UL
Approved Standards	UL E28476
UL Flammability Rating	UL 94V-2

Packaging Features

Packaging Quantity	125
Packaging Method	Box & Carton

Product Compliance

[For compliance documentation, visit the product page on TE.com>](#)

EU RoHS Directive 2011/65/EU	Compliant
EU ELV Directive 2000/53/EC	Compliant
China RoHS 2 Directive MIIT Order No 32, 2016	No Restricted Materials Above Threshold
EU REACH Regulation (EC) No. 1907/2006	Current ECHA Candidate List: JUNE 2023 (235) Candidate List Declared Against: JUNE 2023 (235) Does not contain REACH SVHC
Halogen Content	BFR/CFR/PVC Free, but Br/Cl >900 ppm in other sources.
Solder Process Capability	Not applicable for solder process capability

Product Compliance Disclaimer

This information is provided based on reasonable inquiry of our suppliers and represents our current actual knowledge based on the information they provided. This information is subject to change. The part numbers that TE has identified as EU RoHS compliant have a maximum concentration of 0.1% by weight in homogenous materials for lead, hexavalent chromium, mercury, PBB, PBDE, DBP, BBP, DEHP, DIBP, and 0.01% for cadmium, or qualify for an exemption to these limits as defined in the Annexes of Directive 2011/65/EU (RoHS2). Finished electrical and electronic equipment products will be CE marked as required by Directive 2011/65/EU. Components may not be CE marked. Additionally, the part numbers that TE has identified as EU ELV compliant have a maximum concentration of 0.1% by weight in homogenous materials for lead, hexavalent chromium, and mercury, and 0.01% for cadmium, or qualify for an exemption to these limits as defined in the Annexes of Directive 2000/53/EC (ELV). Regarding the REACH Regulation, the information TE provides on SVHC in articles for this part number is based on the latest European Chemicals Agency (ECHA) 'Guidance on requirements for substances in articles' posted at this URL: <https://echa.europa.eu/guidance-documents/guidance-on-reach>

Compatible Parts



TE Part # CAT-104MTA-NTPMP
MTA Plug: Nylon, Tin Plated, 2.54 mm, with Mating Alignment



TE Part # CAT-104MTA-PRUSH
PCB Header: Polyester, Right Angle, Unshrouded



TE Part # CAT-104MTA-PVSHH
Polyester Vertical PCB Header: 2.54 mm, Shrouded, MTA 100



TE Part # CAT-104MTA-NVSMH
Nylon Vertical PCB Header: 2.54mm, Surface Mount, MTA 100



TE Part # CAT-104MTA-NYLCC
Nylon PCB Connector Covers: 2.54 mm, MTA 100



TE Part # 640454-4
04P MTA100 HDR ASSY SQ STR POL



TE Part # CAT-104MTA-PRSMH
PCB Header, Right Angle, Polyester, 2.54 mm



TE Part # CAT-104MTA-PVUNH
PCB Header: Polyester, Vertical, Unshrouded, No Mating Alignment



TE Part # CAT-104MTA-PLSCC
Polyester PCB Connector Covers: 2.54 mm, MTA 100



TE Part # 640455-4
04P MTA100 HDR ASSY SQ R/A POL



TE Part # CAT-104MTA-PVBRH
Polyester Vertical PCB Header: 2.54 mm, Breakaway, MTA 100



TE Part # CAT-104MTA-NVTHH
Nylong Vertical PCB Header: 2.54mm, Through Hole, MTA 100



TE Part # 58074-1
MTA 50/100/156 MANUAL TOOL FRAME



TE Part # 58246-1
MTA 100 CRIMP HEAD REPAIR DISCRETE



TE Part # 58246-3
MTA 100 CRIMP HEAD PRODUCTION RBN CABLE



TE Part # 58579-1
MTA 100 MANUAL TOOL ASSEMBLY DISCRETE



TE Part # 58039-1
MTA 100 ARBOR FIXTURE DISCRETE RBN CABLE



TE Part # 58246-2
MTA 100 CRIMP HEAD PRODUCTION DISCRETE

Also in the Series | **MTA 100**



Insertion & Extraction Tools(2)



PCB Connector Covers(69)



PCB Connector Keying(1)

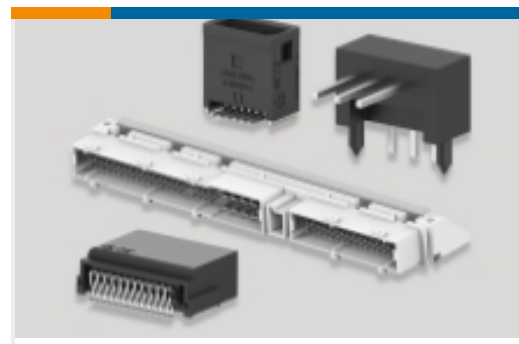

PCB Headers & Receptacles(451)



Standard Rectangular Connectors(497)



Wire-to-Board Connector Assemblies & Housings(1)



Wire-to-Board Connector Contacts(8)

Customers Also Bought



TE Part #4-640441-0
10P MTA100 CONN ASSY WHT

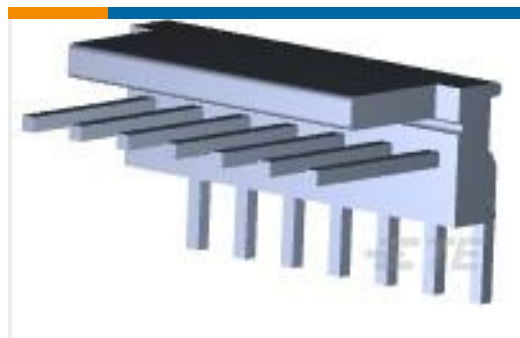

TE Part #640455-7
07P MTA100 HDR ASSY SQ R/A POL



TE Part #1734597-1
1.0 WTB Terminal, Receptacle



TE Part #4-2176056-2
RLP73K 2B R51 5% 5K RL



TE Part #5413779-3
COML BNC,50 OHM, HEX CRIMP

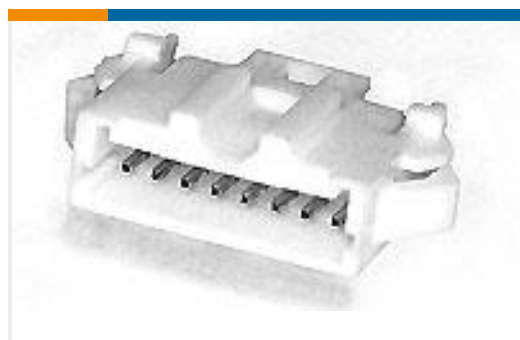

TE Part #1-292215-0
MINI CT SGL RELAY 10P NAT

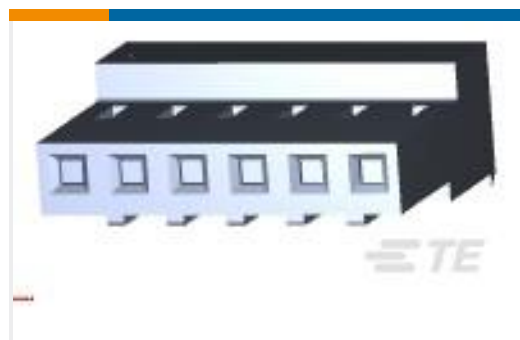

TE Part #3-640433-6
06P MTA156 CONN ASSY 22AWG RED



TE Part #4-173977-3
CT CONN MT REC ASSY 3P YELLOW

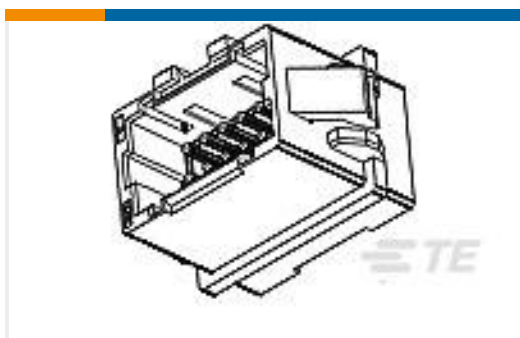

TE Part #2-292216-6
MINI CT D/R RELAY 26P V NAT



TE Part #9-292155-2
SGL HDR PANEL MOUNT ASSY

Documents



Product Drawings

04P MTA100 CONN ASSY GRN

English

CAD Files

Customer View Model

[ENG_CVM_CVM_3-640443-4_U.2d_dxf.zip](#)

English

3D PDF

3D

Customer View Model

[ENG_CVM_CVM_3-640443-4_U.3d_igs.zip](#)

English

Customer View Model

[ENG_CVM_CVM_3-640443-4_U.3d_stp.zip](#)

English

By downloading the CAD file I accept and agree to the [Terms and Conditions](#) of use.

Product Specifications

Application Specification

English

Product Environmental Compliance

[MD_3-640443-4_01202016219_dmtec](#)

English

[MD_3-640443-4_01202016219_dmtec](#)

English

Agency Approvals

UL Report

English