

QTLP651C-R Red

QTLP651C-E Orange

QTLP651C-O Yellow-Orange

QTLP651C-Y Yellow

QTLP651C-AG Yellow-Green

QTLP651C-IG True Green

QTLP651C-IB Blue

## PACKAGE DIMENSIONS

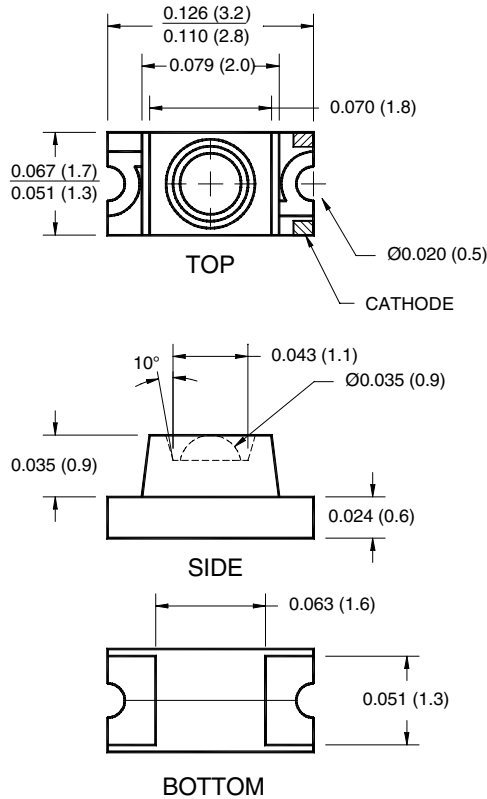

NOTE:

Dimensions for all drawings are in inches (mm).

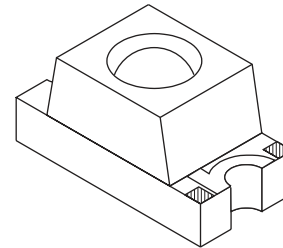

## APPLICATIONS

- Keypad backlighting
- Push-button backlighting
- LCD backlighting

## DESCRIPTION

These surface mount chip LEDs are designed to fit industry standard footprint. The package features a recessed, inner lens that focuses the light output, offering greater luminous intensity for direct viewing.

## FEATURES

- Small footprint - 3.0(L) X 1.5(W) X 1.5(H) mm
- AllInGaP technology for -R, -E, -O, -Y and -AG
- InGaN/SiC technology for -IG and -IB
- Narrow viewing angle of 20°
- Water clear optics
- Moisture-proof packaging
- Available in 0.315" (8mm) width tape on 7" (178mm) diameter reel; 2,000 units per reel

# SURFACE MOUNT LED LAMP

## SUPER BRIGHT 1206 (Inner Lens)

QTLP651C-R Red

QTLP651C-E Orange

QTLP651C-O Yellow-Orange

QTLP651C-Y Yellow

QTLP651C-AG Yellow-Green

QTLP651C-IG True Green

QTLP651C-IB Blue

### ABSOLUTE MAXIMUM RATINGS (T<sub>A</sub> =25°C Unless otherwise specified)

Parameter	Symbol	QTLP651C					Units
		-R	-E	-O	-Y	-AG	
Continuous Forward Current	I <sub>F</sub>	30	30	30	25	30	mA
Peak Forward Current (f = 1.0 KHz, Duty Factor = 1/10)	I <sub>FM</sub>	160	160	160	120	160	mA
Reverse Voltage	V <sub>R</sub>	5	5	5	5	5	V
Power Dissipation	P <sub>D</sub>	72	72	72	60	72	mW
Operating Temperature	T <sub>OPR</sub>	-40 to +85					°C
Storage Temperature	T <sub>STG</sub>	-40 to +90					°C
Lead Soldering Time	T <sub>SOL</sub>	260 for 5 sec					°C

### ABSOLUTE MAXIMUM RATINGS (T<sub>A</sub> =25°C Unless otherwise specified)

Parameter	Symbol	QTLP651C		Units
		-IB	-IG	
Continuous Forward Current	I <sub>F</sub>	30	30	mA
Peak Forward Current (f = 1.0 KHz, Duty Factor = 1/10)	I <sub>FM</sub>	100	100	mA
Reverse Voltage	V <sub>R</sub>	5	5	V
Power Dissipation	P <sub>D</sub>	120	120	mW
Operating Temperature	T <sub>OPR</sub>	-40 to +85		°C
Storage Temperature	T <sub>STG</sub>	-40 to +90		°C
Lead Soldering Time	T <sub>SOL</sub>	260 for 5 sec		°C

QTLP651C-R Red

QTLP651C-E Orange

QTLP651C-O Yellow-Orange

QTLP651C-Y Yellow

QTLP651C-AG Yellow-Green

QTLP651C-IG True Green

QTLP651C-IB Blue

### ELECTRICAL / OPTICAL CHARACTERISTICS (T<sub>A</sub> =25°C)

Part Number	Symbol	QTLP651C					Condition
		-R	-E	-O	-Y	-AG	
Luminous Intensity (mcd)	I <sub>v</sub>	25	25	25	25	15	I <sub>F</sub> = 20mA
Minimum		70	70	70	70	30	
Typical							
Forward Voltage (V)	V <sub>F</sub>	2.4	2.4	2.4	2.4	2.4	I <sub>F</sub> = 20mA
Maximum		2.0	2.0	2.0	2.0	2.0	
Typical							
Wavelength (nm)	λ <sub>P</sub>	630	620	610	590	575	I <sub>F</sub> = 20mA
Peak		624	615	605	589	573	
Dominant	λ <sub>D</sub>						
Spectral Line Half Width (nm)	Δλ	20	18	18	15	20	I <sub>F</sub> = 20mA
Viewing Angle (°)	2Θ <sub>1/2</sub>	20	20	20	20	20	I <sub>F</sub> = 20mA

### ELECTRICAL / OPTICAL CHARACTERISTICS (T<sub>A</sub> =25°C)

Part Number	Symbol	QTLP651C		Condition
		-IB	-IG	
Luminous Intensity (mcd)	I <sub>v</sub>	35	100	I <sub>F</sub> = 20mA
Minimum		45	140	
Typical				
Forward Voltage (V)	V <sub>F</sub>	4.0	4.0	I <sub>F</sub> = 20mA
Maximum		3.5	3.5	
Typical				
Wavelength (nm)	λ <sub>P</sub>	465	520	I <sub>F</sub> = 20mA
Peak		470	525	
Dominant	λ <sub>D</sub>			
Spectral Line Half Width (nm)	Δλ	25	35	I <sub>F</sub> = 20mA
Viewing Angle (°)	2Θ <sub>1/2</sub>	20	20	I <sub>F</sub> = 20mA

QTLP651C-R Red

QTLP651C-E Orange

QTLP651C-O Yellow-Orange

QTLP651C-Y Yellow

QTLP651C-AG Yellow-Green

QTLP651C-IG True Green

QTLP651C-IB Blue

**TYPICAL PERFORMANCE CURVES (QTLP651C-R, -E, -O, -Y and -AG)**

**Fig. 1 Forward Current vs. Forward Voltage**

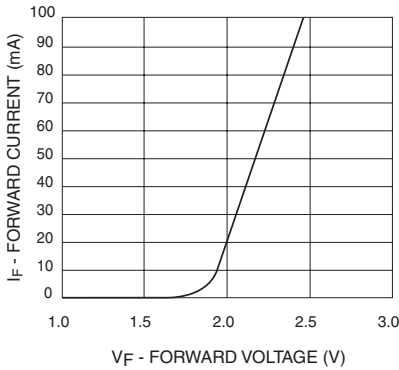

**Fig. 2 Relative Luminous Intensity vs. DC Forward Current**

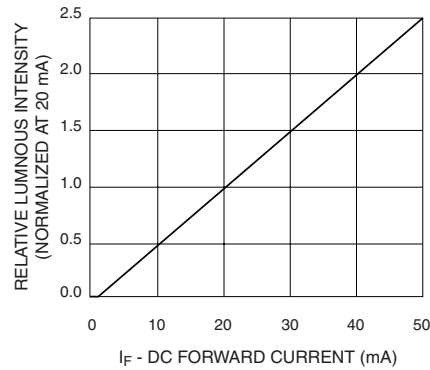

**Fig. 3 Relative Intensity vs. Peak Wavelength**

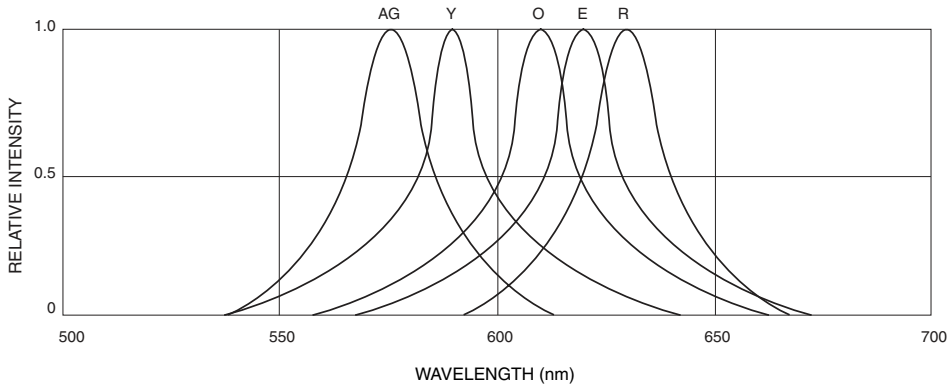

**Fig.4 Radiation Diagram**

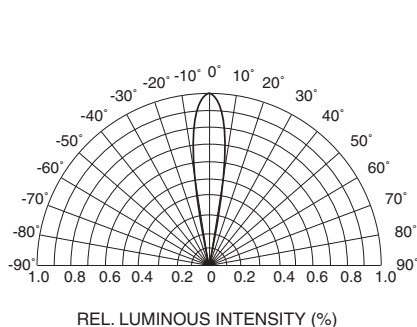

**Fig.5 Maximum Forward Current vs. Ambient Temperature**

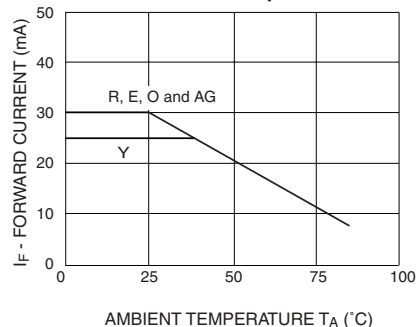

QTLP651C-R Red

QTLP651C-E Orange

QTLP651C-O Yellow-Orange

QTLP651C-Y Yellow

QTLP651C-AG Yellow-Green

QTLP651C-IG True Green

QTLP651C-IB Blue

## TYPICAL PERFORMANCE CURVES (QTLP651C-IG and IB)

Fig. 1 Forward Current vs. Forward Voltage

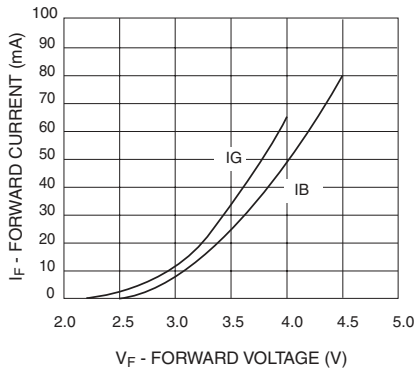

Fig. 2 Relative Luminous Intensity vs. DC Forward Current

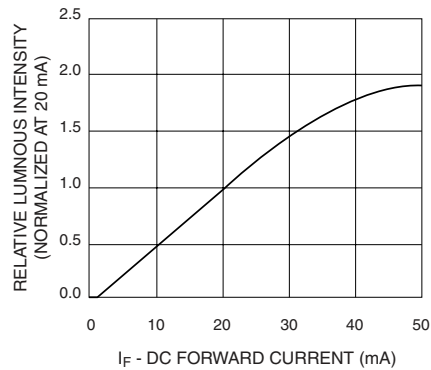

Fig. 3 Relative Intensity vs. Peak Wavelength

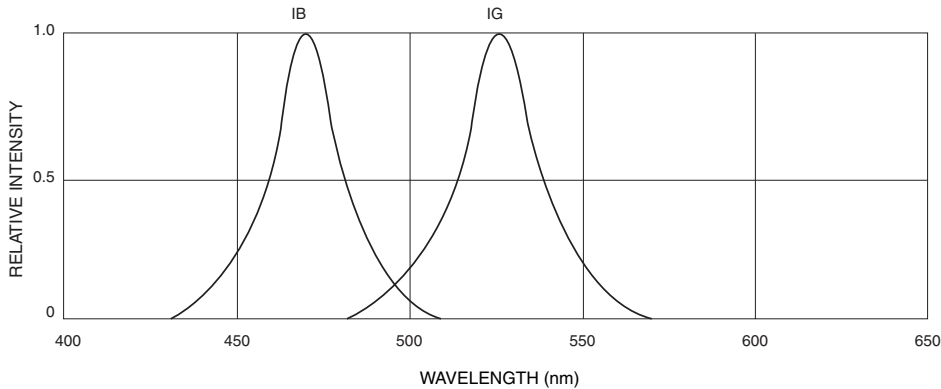

Fig.4 Radiation Diagram

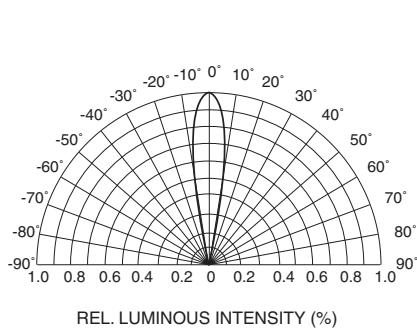
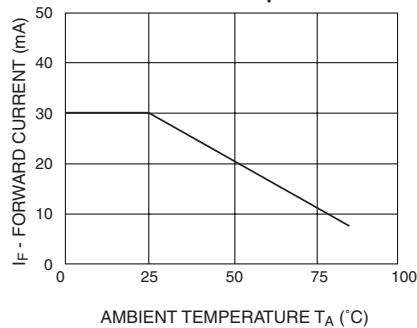

Fig.5 Maximum Forward Current vs. Ambient Temperature



QTLP651C-R Red

QTLP651C-E Orange

QTLP651C-O Yellow-Orange

QTLP651C-Y Yellow

QTLP651C-AG Yellow-Green

QTLP651C-IG True Green

QTLP651C-IB Blue

## RECOMMENDED PRINTED CIRCUIT BOARD PATTERN

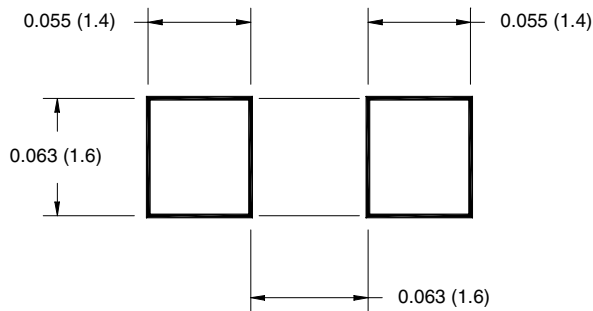

## RECOMMENDED IR REFLOW SOLDERING PROFILE

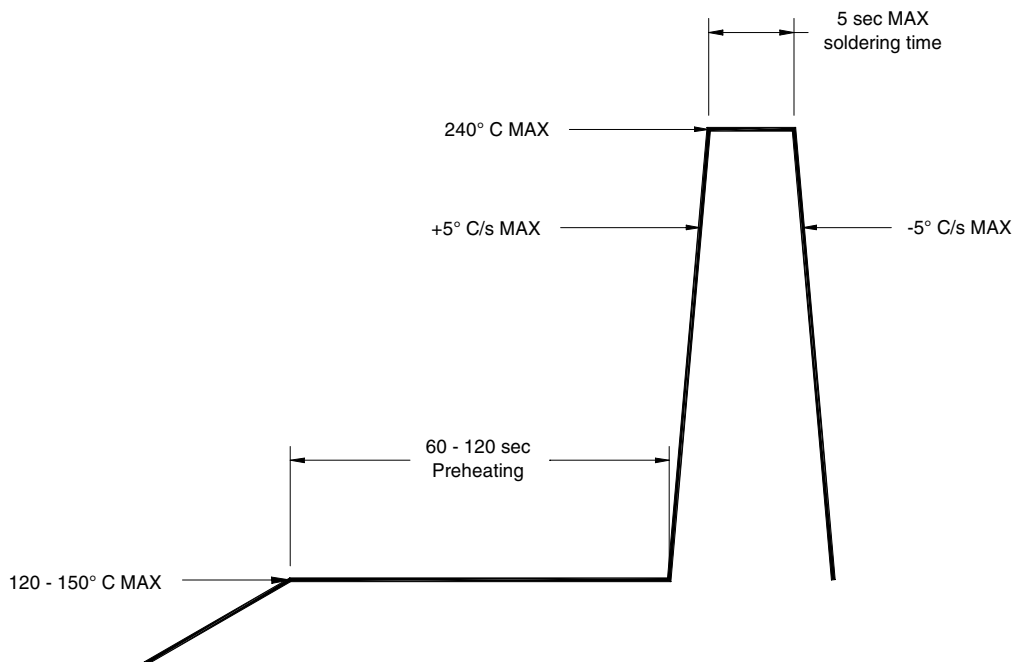

QTLP651C-R Red

QTLP651C-E Orange

QTLP651C-O Yellow-Orange

QTLP651C-Y Yellow

QTLP651C-AG Yellow-Green

QTLP651C-IG True Green

QTLP651C-IB Blue

## TAPE AND REEL DIMENSIONS

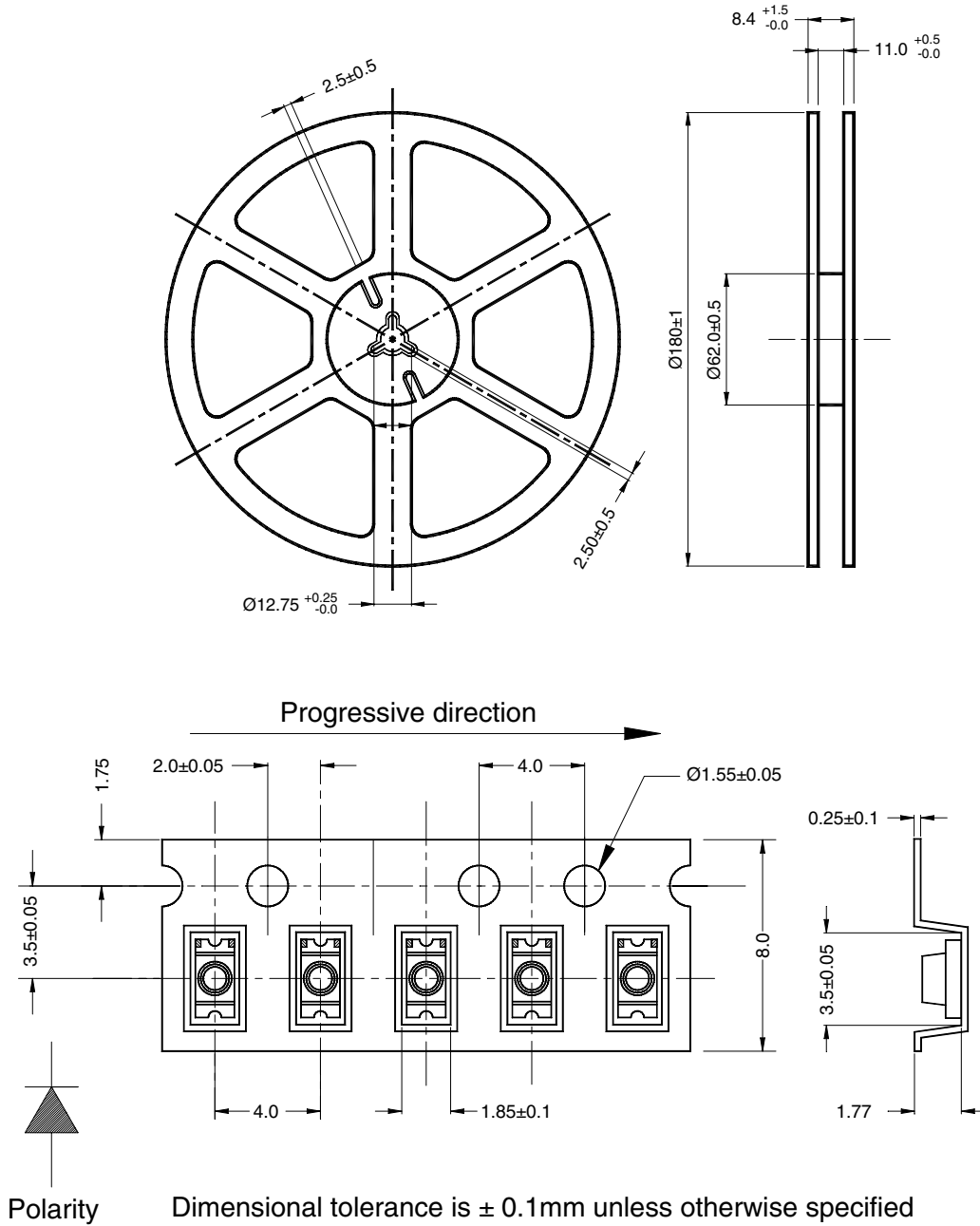

Dimensional tolerance is  $\pm 0.1\text{mm}$  unless otherwise specified

Angle:  $\pm 0.5$

Unit: mm

---

**QTLP651C-R** Red

**QTLP651C-E** Orange

**QTLP651C-O** Yellow-Orange

**QTLP651C-Y** Yellow

**QTLP651C-AG** Yellow-Green

**QTLP651C-IG** True Green

**QTLP651C-IB** Blue

---

### DISCLAIMER

FAIRCHILD SEMICONDUCTOR RESERVES THE RIGHT TO MAKE CHANGES WITHOUT FURTHER NOTICE TO ANY PRODUCTS HEREIN TO IMPROVE RELIABILITY, FUNCTION OR DESIGN. FAIRCHILD DOES NOT ASSUME ANY LIABILITY ARISING OUT OF THE APPLICATION OR USE OF ANY PRODUCT OR CIRCUIT DESCRIBED HEREIN; NEITHER DOES IT CONVEY ANY LICENSE UNDER ITS PATENT RIGHTS, NOR THE RIGHTS OF OTHERS.

### LIFE SUPPORT POLICY

FAIRCHILD'S PRODUCTS ARE NOT AUTHORIZED FOR USE AS CRITICAL COMPONENTS IN LIFE SUPPORT DEVICES OR SYSTEMS WITHOUT THE EXPRESS WRITTEN APPROVAL OF THE PRESIDENT OF FAIRCHILD SEMICONDUCTOR CORPORATION. As used herein:

1. Life support devices or systems are devices or systems which, (a) are intended for surgical implant into the body, or (b) support or sustain life, and (c) whose failure to perform when properly used in accordance with instructions for use provided in labeling, can be reasonably expected to result in a significant injury of the user.
2. A critical component in any component of a life support device or system whose failure to perform can be reasonably expected to cause the failure of the life support device or system, or to affect its safety or effectiveness.