

Emergency stop and safety guard monitoring 1 channel KNA3-YS Part number 85102035



- "Emergency stop" & "Gate monitoring" functions
- Single channel operation
- Security with redundancy and feedback circuit
- 3 "NO" security contacts
- 1 "NC" monitoring contact
- Security category 3 (according to EN 954-1)
- Performance Level (PL) d, safety category 3 to EN ISO 13849-1
- SIL Claimed Level (SIL CL) 2 to IEC/EN 62061
- Terminals : fixed screw terminals or plugin cage clamp terminals

Part numbers

Type	Terminals	Voltages	Supply frequency range (Hz)	Outputs
85102035 KNA3-YS	Screws	230 VAC	50/60	3 NO + 1 NC

Specifications

Operating characteristics

Functions	Emergency stop Monitoring of safety gates
Operation	1 channel
Control input	Manual restart with On-button (Y1 - Y2 terminals) Automatic restart (Y1 - Y2 linked)
Failure detection	Between terminal Y1 and common
Display of output state by LED	Power supply : PWR Outputs : OUT (relays K1 & K2)

Supply

Supply voltage	85 102 031 / 85 103 031 : 24 VDC 85 102 034 / 85 103 034 : 110 VAC 85 102 035 / 85 103 035 : 230 VAC
Supply frequency range (Hz)	50 / 60 for AC versions
Operating range	AC : -15 % / +10 % U DC : ± 10 % U (at 10 % residual ripple) DC : - 15 % / +10 % U (at 48 % residual ripple)
Consumption	1,5 W (24 VDC) 3,5 VA (230 VAC)
Initialization time	0,5 s

Precision

Maximum reset time	40 ms (24 VDC) 200 ms (230 VAC)
Maximum response time on emergency stop	70 ms (24 VDC) 35 ms (230 VAC)

Output specification

Type	Forcibly guided relays (positively driven)
Number of safety circuits	3 NO
Number of data circuits	1 NF
Nominal output voltage	250 VAC max.
Max. thermal current I for each contact	5 A
Maximum power rating	According to AC15 (NO contacts) : 3 A / 230 V AC According to AC15 (NC contacts) : 2 A / 230 VAC According to DC13 (NO contacts) : 4 A / 24 VDC ; 0,5 A / 110 VDC According to DC13 (NC contacts) : 4 A / 24 VDC
Electrical endurance	At 5 A, 230 VAC, $\cos \phi = 1$: $1,5 \times 10^5$ switching cycles At 8 A, 24 VDC, according to DC 13 (NO contacts) : 25×10^3 (ON : 0,4 s ; OFF : 9,6 s)
Mechanical life	20×10^6 switching cycles
Maximum rate	600 switching cycles / h
Protection against short circuits	Max. fuse rating : 10 A gL Line circuit breaker : B 6 A

Climatic environment

Operating temperature (°C)	-15 → +55 °C
Storage temperature (°C)	-25 → +85 °C
Altitude	< 2000m
Climate resistance according to IEC/EN 60068-1	15 / 055 / 04

Mechanical environment

Vibration resistance according to IEC/EN 60068-2-6	Amplitude : 0,35 mm Frequency : 10 →55 Hz
--	--

Electromagnetic environment

Immunity to electrostatic discharges acc. IEC/EN 61000-4-2	8 kV (air)
Immunity to radiated, radio-frequency, electromagnetic field acc. IEC/EN 61000-4-3	10 V / m
Immunity to rapid transient bursts acc. to IEC/EN 61000-4-4	2 kV
Immunity to shock waves according to IEC/EN 61000-4-5	Between wires for power supply : 1 kV Between wires and ground : 2 kV
Immunity to radio frequency in common mode acc. to IEC/EN 61000-4-6	10 V
Interference suppression according to IEC/EN 55011	Limit value class B

Housing

Material : self-extinguishing (UL94VO)	Thermoplastic with V0 extinction behaviour
Protection (IEC/EN 60529) - Casing	IP40
Protection (IEC/EN 60529) - Term. block	IP20
Mounting	DIN-rail
Weight (g)	200 (24 VDC) 270 (230 VAC)

Safety standards

Approvals	CE, TÜV, cULus
Environmental directive 2002/95/CE	RoHS
Environmental regulation 1907/2006	Reach
Security data according to EN ISO 13849-1	Performance Level (PL) : d Category : 3
SIL Claimed Level (SIL CL) to IEC/EN 62061	2
Safety Integrity Level (SIL) according to CEI/EN 61508	2
Safety category to EN 954-1	3

Principles

EN ISO 13849-1:		
Category:	3	
PL:	d	
MTTF _d :	180,3	a (year)
DC _{avg} :	99,0	%
d _{op} :	365	d/a (days/year)
h _{op} :	24	h/d (hours/day)
t _{cycle} :	3600	s/cycle
	≅ 1	/h (hour)
IEC EN 62061 IEC EN 61508:		
SIL CL:	2	IEC EN 62061
SIL	2	IEC EN 61508
HFT ^{*)} :	1	
DC _{avg} :	99,0	%
SFF	99,7	%
PFH _D :	2,60E-10	h ⁻¹
*) HFT = Hardware failure tolerance		

Dimensions (mm)



Dimensions (mm)

KNA3-YS - Screw terminals

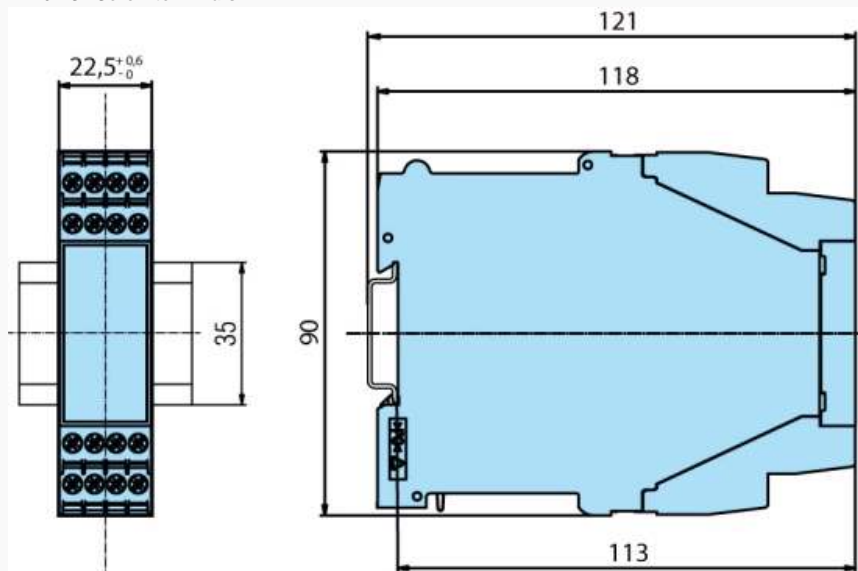

Curves

Function diagram

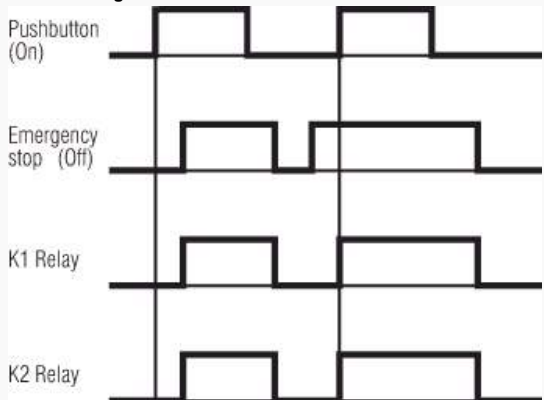

Connections

Front face drawing KNA3-YS

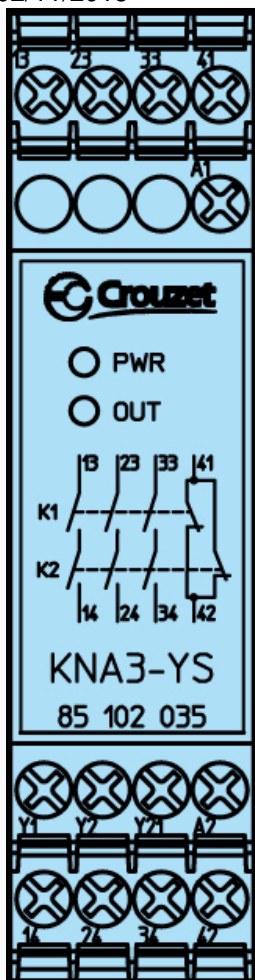

Connections

Contacts

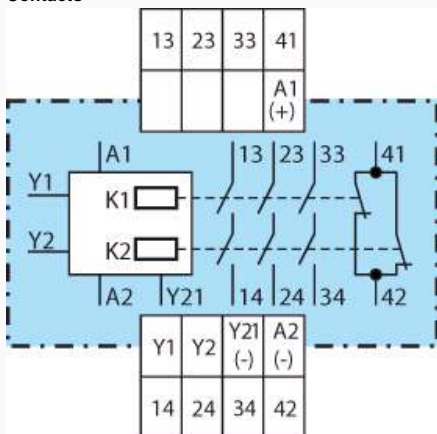

A1 (+) : + / L A2 : - / N Y1, Y2 : Validation Input Y21 (-) : Measure Output (-) of secondary used for example in IT networks for insulation control 13, 14, 23, 24, 33, 34 : Safety circuit outputs (forcibly guided NO contacts) 41, 42 : Monitoring output (forcibly guided NC contact)

Applications

Single channel emergency-stop circuit without feed back loop, with or without automatic restart

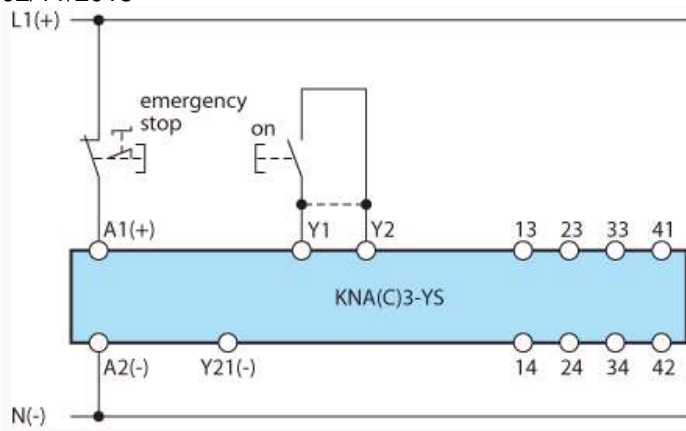

For automatic restart, terminals Y1 - Y2 must be linked. No ON-pushbutton necessary

Applications

Contact reinforcement by external contactors

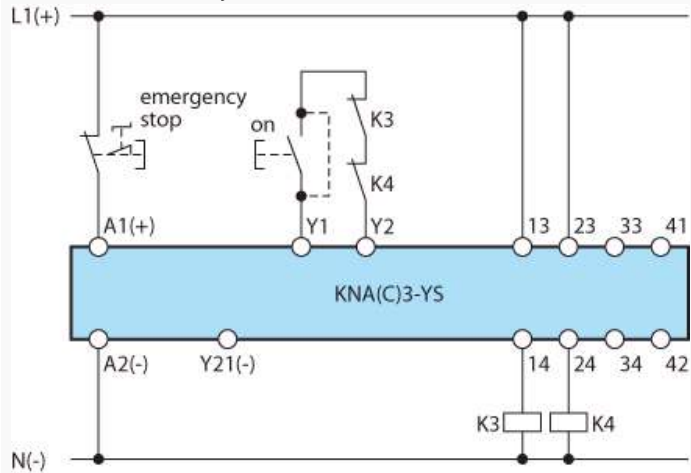

For currents > 5 A, the output contacts can be reinforced by external contactors. Functioning of the external contactors is monitored by looping the NC contacts into the start circuit (Y1-Y2)