

10 9 8 7 6 5 4 3 2 1

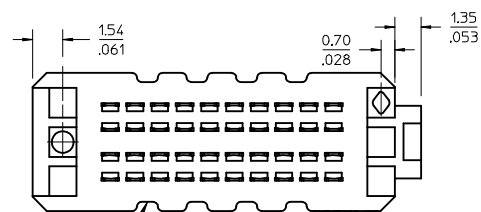

10 POSITION VERSION SHOWN IN THESE VIEWS

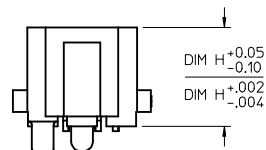
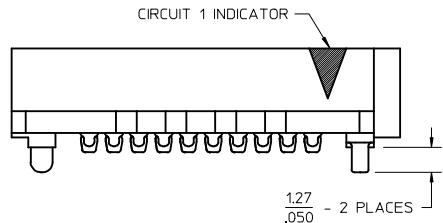
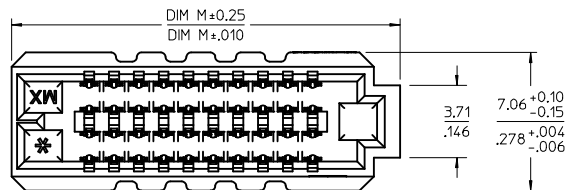
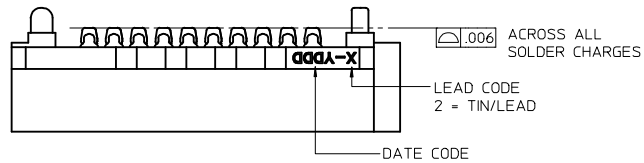
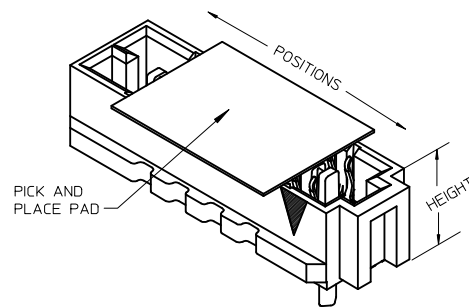

NOTES:

- MATERIALS: HOUSING- LCP, GLASS FILLED, UL94V-0, BLACK CONTACTS- COPPER ALLOY SOLDER CHARGE: 63% TIN, 37% LEAD
- FINISHES: 30 MICROINCH MINIMUM GOLD IN THE CONTACT AREA, 50 MICROINCH MINIMUM TIN IN THE TAIL AREA, OVERALL NICKEL UNDERPLATE.
- PRODUCT SPECIFICATION: PS-45970-001
- PACKAGING SPECIFICATION: PK-45971-002
- MATES WITH SEARAY SLIM PLUG ASSY 46556
- APPLICATION SPECIFICATION: AS-45970-001
- COSMETIC SPECIFICATION: PS-45499-002 CLASS B
- PART STATUS: CONTACT MOLEX

POSITIONS	DIM M		TOTAL NUMBER OF EDGE NOTCHES
10	19.86/782	0.15/.006	8
15	26.21/1032	0.15/.006	14
20	32.56/1282	0.15/.006	18
25	38.91/1532	0.15/.006	24
30	45.26/1782	0.15/.006	28
35	51.62/2032	0.15/.006	34
40	57.96/2282	0.15/.006	36
45	64.31/2532	0.23/.009	44
50	70.66/2782	0.23/.009	48

EDGE NOTCHES- SEE TABLE (THE NUMBER OF NOTCHES INCREASES AS THE NUMBER OF POSITIONS INCREASES)

<b>INITIAL RELEASE</b> EC NO: UCP2015-1206 DRWR:RWHIPPLE 2014/10/22 CHKCD:DMORGAN 2014/10/22 APPR:SMILLER 2015/01/05	QUALITY SYMBOLS   	GENERAL TOLERANCES (UNLESS SPECIFIED)		DIMENSION STYLE MM/IN		SCALE 4:1	DESIGN UNITS INCH	THIRD ANGLE PROJECTION	
		4 PLACES ± --- ± ---	DRAWN BY RWHIPPLE	DATE 2014/10/22	TITLE SEARAY SLIM (4 ROW) RECEPTACLE ASSEMBLY 1.27/.050 PITCH TIN/LEAD <b>molex</b>		DOCUMENT NO. RSD-46557-001	SHEET NO. 1 OF 3	
		3 PLACES ± --- ± .010	CHECKED BY DMORGAN	DATE 2014/10/22					
		2 PLACES ± 0.25 ± .015	APPROVED BY SMILLER	DATE 2015/01/05	MATERIAL NO. SEE TABLE SHT 3				
1 PLACE ± 0.38 ± ---	ANGULAR ± --- ° DRAFT WHERE APPLICABLE MUST REMAIN WITHIN DIMENSIONS		SIZE B	THIS DRAWING CONTAINS INFORMATION THAT IS PROPRIETARY TO MOLEX INCORPORATED AND SHOULD NOT BE USED WITHOUT WRITTEN PERMISSION					
0 PLACE ± ±									

9 8 7 6 5 4 3 2 1

10 9 8 7 6 5 4 3 2 1

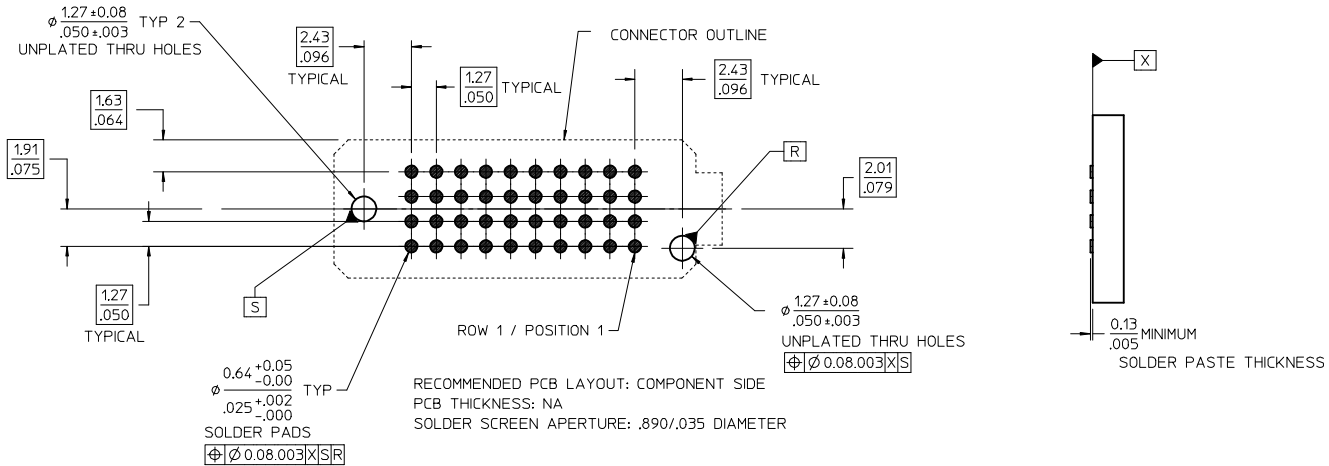

		DIM R RECEPTACLE STACK HEIGHT					
		MM	5.0	6.0	6.5	7.5	8.0
DIM P PLUG STACK HEIGHT	2.0	7.0	8.0	8.5	9.5	10.0	11.0
	3.0	8.0	9.0	9.5	10.5	11.0	11.0
	3.5	8.5	9.5	10.0	11.0	11.5	11.5
	2.5	7.5	8.5	9.0	10.0	10.5	10.5
	4.5	9.5	10.5	11.0	12.0	12.5	12.5
	5.0	10.0	11.0	11.5	12.5	13.0	13.0
	7.0	12.0	13.0	13.5	14.5	15.0	15.0

MATED STACK HEIGHTS  
 GIVEN IN MILLIMETERS (MM) FOR REFERENCE ONLY

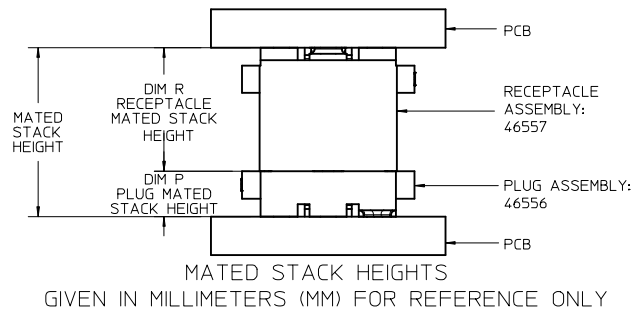

SEE SHEET 1 EC NO: UCP2015-1206 DRAWN BY: RWHIPPLE 2014/10/22 CHKD: DMORGAN 2014/10/22 APPR: SMILLER 2015/01/05	QUALITY SYMBOLS $\nabla$ / 0 $\nabla$ / 0 $\nabla$ / 0	GENERAL TOLERANCES (UNLESS SPECIFIED)		DIMENSION STYLE		SCALE	DESIGN UNITS	THIRD ANGLE PROJECTION		
		mm	INCH	MM/IN		4:1	INCH			
		4 PLACES ± --- ± ---	3 PLACES ± --- ± .010	DRAWN BY	DATE	TITLE				
		2 PLACES ± 0.25 ± .015	1 PLACE ± 0.38 ± ---	0 PLACE ± ±	RWHIPPLE 2014/10/22	DMORGAN 2014/10/22	SEARAY SLIM (4 ROW) RECEPTACLE ASSEMBLY 1.27/.050 PITCH TIN/LEAD			
ANGULAR ± --- °		DRAFT WHERE APPLICABLE MUST REMAIN WITHIN DIMENSIONS		MATERIAL NO.		DOCUMENT NO.		SHEET NO.		
				SEE TABLE SHT 3		RSD-46557-001		2 OF 3		
				THIS DRAWING CONTAINS INFORMATION THAT IS PROPRIETARY TO MOLEX INCORPORATED AND SHOULD NOT BE USED WITHOUT WRITTEN PERMISSION						

9 8 7 6 5 4 3 2 1

10 9 8 7 6 5 4 3 2 1

DIM R: (REF)	5.0 MM	6.0 MM	6.5 MM	7.5 MM	8.0 MM
DIM H:	5.04/.199	6.04/.238	6.55/.258	7.54/.297	8.05/.317
POSITIONS	MATERIAL NO	MATERIAL NO	MATERIAL NO	MATERIAL NO	MATERIAL NO
10	46557-1147	46557-1247	46557-1347	46557-1447	46557-1547
20	46557-2147	46557-2247	46557-2347	46557-2447	46557-2547
30	46557-3147	46557-3247	46557-3347	46557-3447	46557-3547
40	46557-4147	46557-4247	46557-4347	46557-4447	46557-4547
50	46557-5147	46557-5247	46557-5347	46557-5447	46557-5547
15	46557-6147	46557-6247	46557-6347	46557-6447	46557-6547
25	46557-7147	46557-7247	46557-7347	46557-7447	46557-7547
35	46557-8147	46557-8247	46557-8347	46557-8447	46557-8547
45	46557-9147	46557-9247	46557-9347	46557-9447	46557-9547

MATED STACK HEIGHTS  
GIVEN IN MILLIMETERS (MM) FOR REFERENCE ONLY

SEE SHEET 1 EC NO: UCP2015-1206 DRAWN: RWHIPPLE 2014/10/22 CHKD: DMORGAN 2014/10/22 APPR: SMILLER 2015/01/05	DESCRIPTION REV	QUALITY SYMBOLS	GENERAL TOLERANCES (UNLESS SPECIFIED)	DIMENSION STYLE	SCALE	DESIGN UNITS	THIRD ANGLE PROJECTION
		$\nabla = 0$ $\nabla = 0$ $\nabla = 0$	mm      INCH 4 PLACES ± --- ± --- 3 PLACES ± --- ± .010 2 PLACES ± 0.25 ± .015 1 PLACE ± 0.38 ± --- 0 PLACE ±      ±	MM/IN	1:1	INCH	SEARAY SLIM (4 ROW) RECEPTACLE ASSEMBLY 1.27/.050 PITCH TIN/LEAD
		ANGULAR ± ---° DRAFT WHERE APPLICABLE MUST REMAIN WITHIN DIMENSIONS	DRAWN BY DATE RWHIPPLE 2014/10/22 CHECKED BY DATE DMORGAN 2014/10/22 APPROVED BY DATE SMILLER 2015/01/05	TITLE			
		A	MATERIAL NO.	DOCUMENT NO.	SHEET NO.		
	B	SEE TABLE	RSD-46557-001	3 OF 3			
THIS DRAWING CONTAINS INFORMATION THAT IS PROPRIETARY TO MOLEX INCORPORATED AND SHOULD NOT BE USED WITHOUT WRITTEN PERMISSION							

9 8 7 6 5 4 3 2 1