

OMNIMATE Signal - series LMF LMF 5.00/22/90 3.5SN OR BX

Weidmüller Interface GmbH & Co. KG
Klingenbergstraße 16
D-32758 Detmold
Germany
Fon: +49 5231 14-0
Fax: +49 5231 14-292083
www.weidmueller.com

Product image

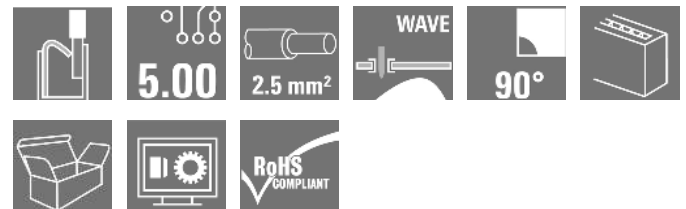

Similar to illustration

The new LMF allows us to meet the current market requirements for a PCB terminal with PUSH IN connection system for wire cross-sections up to 2.5 mm²

- PUSH IN connection system
- LMF with pusher for opening the terminal point
- LMFS without pusher, the terminal point is opened with a screwdriver
- Integrated test point
- 90° and 180° wire outlet direction

General ordering data

| | |
|--------------|---|
| Type | LMF 5.00/22/90 3.5SN OR BX |
| Order No. | 1331930000 |
| Version | Printed circuit board terminals, 5.00 mm, No. of poles: 22, 90°, Solder pin length (l): 3.5 mm, tinned, orange, PUSH IN, Clamping range, max. : 2.5 mm ² , Box |
| GTIN (EAN) | 4050118135701 |
| Qty. | 10 pc(s). |
| Product data | IEC: 400 V / 24 A / 0.5 - 2.5 mm ² UL: 300 V / 20 A / AWG 24 - AWG 12 |
| Packaging | Box |

OMNIMATE Signal - series LMF
LMF 5.00/22/90 3.5SN OR BX

Weidmüller Interface GmbH & Co. KG
 Klingenbergstraße 16
 D-32758 Detmold
 Germany
 Fon: +49 5231 14-0
 Fax: +49 5231 14-292083
 www.weidmueller.com

Technical data**Dimensions and weights**

| | | | |
|--------------------------|------------|-----------------|------------|
| Width | 112.7 mm | Width (inches) | 4.437 inch |
| Height | 18.3 mm | Height (inches) | 0.72 inch |
| Height of lowest version | 14.8 mm | Depth | 19.2 mm |
| Depth (inches) | 0.756 inch | Net weight | 31.27 g |

System parameters

| | | | |
|--|------------------------------|--|------------|
| Product family | OMNIMATE Signal - series LMF | Wire connection method | PUSH IN |
| Mounting onto the PCB | THT solder connection | Conductor outlet direction | 90° |
| Pitch in mm (P) | 5 mm | Pitch in inches (P) | 0.197 inch |
| No. of poles | 22 | Fitted by customer | No |
| Max. adjacent poles per row | 24 | Solder pin length (l) | 3.5 mm |
| Solder pin dimensions | d = 0.8 mm | Solder eyelet hole diameter (D) | 1.1 mm |
| Solder eyelet hole diameter tolerance (D)+ | 0,1 mm | Number of solder pins per pole | 2 |
| Screwdriver blade | 0.6 x 3.5 | Screwdriver blade standard | DIN 5264 |
| Stripping length | 10 mm | L1 in mm | 105 mm |
| L1 in inches | 4.134 inch | Touch-safe protection acc. to DIN VDE 0470 | IP 20 |
| Touch-safe protection acc. to DIN VDE 57 106 | Safe from finger touch | | |

Material data

| | | | |
|---------------------------------------|---------------------|---------------------------------------|--------|
| Insulating material | Wemid (PA) | Colour code | orange |
| Colour chart (similar) | RAL 2000 | CTI | ≥ 600 |
| Insulation strength | ≥ 10 ⁸ Ω | UL 94 flammability rating | V-0 |
| Contact material | CuSn | Contact surface | tinned |
| Coating | 4-6 µm SN | Tinning type | matt |
| Layer structure of solder connection | 4-6 µm Sn matt | Storage temperature, min. | -25 °C |
| Storage temperature, max. | 55 °C | Max. relative humidity during storage | 80 % |
| Operating temperature, min. | -50 °C | Operating temperature, max. | 120 °C |
| Temperature range, installation, min. | -25 °C | Temperature range, installation, max. | 120 °C |

Conductors suitable for connection

| | | | |
|---|----------------------|---|---------------------|
| Clamping range, min. | 0.12 mm ² | Clamping range, max. | 2.5 mm ² |
| Wire connection cross section AWG, min. | AWG 24 | Wire connection cross section AWG, max. | AWG 12 |
| Solid, min. H05(07) V-U | 0.5 mm ² | Solid, max. H05(07) V-U | 2.5 mm ² |
| Flexible, min. H05(07) V-K | 0.25 mm ² | Flexible, max. H05(07) V-K | 2.5 mm ² |
| w. plastic collar ferrule, DIN 46228 pt 4, min. | 0.25 mm ² | w. plastic collar ferrule, DIN 46228 pt 4, max. | 2.5 mm ² |
| w. wire end ferrule, DIN 46228 pt 1, min. | 0.25 mm ² | w. wire end ferrule, DIN 46228 pt 1, max. | 2.5 mm ² |
| Plug gauge in accordance with EN 60999 a x b; ø | 2.4 mm x 1.5 mm | | |

OMNIMATE Signal - series LMF LMF 5.00/22/90 3.5SN OR BX

Weidmüller Interface GmbH & Co. KG
Klingenbergstraße 16
D-32758 Detmold
Germany
Fon: +49 5231 14-0
Fax: +49 5231 14-292083
www.weidmueller.com

Technical data

Rated data acc. to IEC

| | | | |
|---|------------------------|---|-------------------|
| tested acc. to standard | IEC 60664-1, IEC 61984 | Rated current, min. no. of poles (Tu=20°C) | 24 A |
| Rated current, max. no. of poles (Tu=20°C) | 24 A | Rated current, min. no. of poles (Tu=40°C) | 24 A |
| Rated current, max. no. of poles (Tu=40°C) | 24 A | Rated voltage for surge voltage class / pollution degree II/2 | 400 V |
| Rated voltage for surge voltage class / pollution degree III/2 | 320 V | Rated voltage for surge voltage class / pollution degree III/3 | 250 V |
| Rated impulse voltage for surge voltage class/ pollution degree II/2 | 4 kV | Rated impulse voltage for surge voltage class/ pollution degree III/2 | 4 kV |
| Rated impulse voltage for surge voltage class/ contamination degree III/3 | 4 kV | Short-time withstand current resistance | 3 x 1s with 120 A |

Rated data acc. to CSA

| | | | |
|-----------------------------------|--|-----------------------------------|---------------|
| Institute (CSA) | | Certificate No. (CSA) | 20039-1815154 |
| Rated voltage (Use group B / CSA) | 300 V | Rated voltage (Use group D / CSA) | 300 V |
| Rated current (Use group B / CSA) | 20 A | Rated current (Use group D / CSA) | 10 A |
| Wire cross-section, AWG, min. | AWG 24 | Wire cross-section, AWG, max. | AWG 12 |
| Reference to approval values | Specifications are maximum values, details - see approval certificate. | | |

Rated data acc. to UL 1059

| | | | |
|---------------------------------------|--|---------------------------------------|--------|
| Institute (cURus) | | Certificate No. (cURus) | E60693 |
| Rated voltage (Use group B / UL 1059) | 300 V | Rated voltage (Use group D / UL 1059) | 300 V |
| Rated current (Use group B / UL 1059) | 20 A | Rated current (Use group D / UL 1059) | 10 A |
| Wire cross-section, AWG, min. | AWG 24 | Wire cross-section, AWG, max. | AWG 12 |
| Reference to approval values | Specifications are maximum values, details - see approval certificate. | | |

Packaging

| | | | |
|-----------|--------|------------|--------|
| Packaging | Box | VPE length | 348 mm |
| VPE width | 135 mm | VPE height | 30 mm |

Classifications

| | | | |
|------------|-------------|------------|-------------|
| ETIM 3.0 | EC001284 | ETIM 4.0 | EC002643 |
| ETIM 5.0 | EC002643 | ETIM 6.0 | EC002643 |
| eClass 6.2 | 27-26-11-01 | eClass 7.1 | 27-44-04-01 |
| eClass 8.1 | 27-44-04-01 | eClass 9.0 | 27-44-04-01 |
| eClass 9.1 | 27-44-04-01 | | |

Data sheet

**OMNIMATE Signal - series LMF
LMF 5.00/22/90 3.5SN OR BX**

Weidmüller Interface GmbH & Co. KG
Klingenbergstraße 16
D-32758 Detmold
Germany
Fon: +49 5231 14-0
Fax: +49 5231 14-292083
www.weidmueller.com

Technical data

Notes

- | | |
|-------|--|
| Notes | <ul style="list-style-type: none"> • Additional colours on request • Rated current related to rated cross-section & min. No. of poles. • Wire end ferrule without plastic collar to DIN 46228/1 • Wire end ferrule with plastic collar to DIN 46228/4 • P on drawing = pitch • Rated data refer only to the component itself. Clearance and creepage distances to other components are to be designed in accordance with the relevant application standards. • The test point can only be used as potential-pickup point. |
|-------|--|

| | |
|----------------|--|
| IPC conformity | Conformity: The products are developed, manufactured and delivered according international recognized standards and norms and comply with the assured properties in the data sheet resp. fulfill decorative properties in accordance with IPC-A-610 "Class 2". Further claims on the products can be evaluated on request. |
|----------------|--|

Approvals

Approvals



| | |
|------|---------|
| ROHS | Conform |
|------|---------|

Downloads

| | |
|---|---|
| Approval/Certificate/Document of Conformity | Declaration of the Manufacturer |
| Brochure/Catalogue | FL DRIVES EN FL ANALO.SIGN.CONV. EN MB DEVICE MANUF. EN FL DRIVES DE CAT 2 PORTEFOLIOGUIDE EN FL BUILDING SAFETY EN FL APPL LED LIGHTING EN FLIndustr.CONTROLS EN FL MACHINE SAFETY EN FL HEATING ELECTR EN FL APPL INVERTER EN FL BASE STATION EN FL ELEVATOR EN FL POWER SUPPLY EN FL 72H SAMPLE SER EN PO OMNIMATE EN |
| Engineering Data | EPLAN.WSCAD |

OMNIMATE Signal - series LMF
LMF 5.00/22/90 3.5SN OR BX

Weidmüller Interface GmbH & Co. KG
 Klingenbergstraße 16
 D-32758 Detmold
 Germany
 Fon: +49 5231 14-0
 Fax: +49 5231 14-292083
 www.weidmueller.com

Drawings

Dimensional drawing

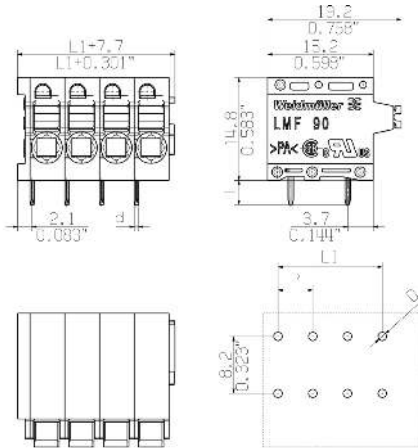

Graph

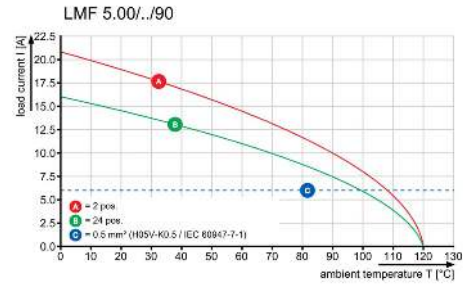

Graph

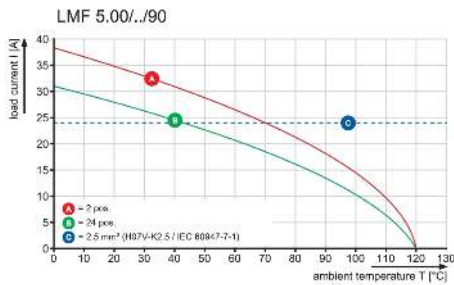

Product benefits

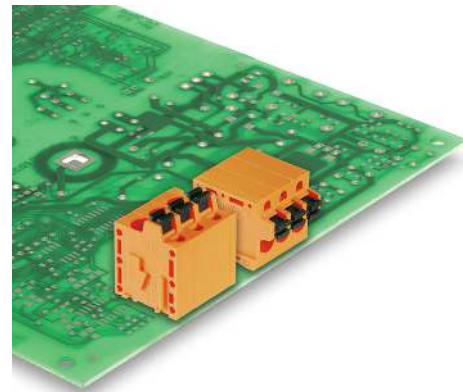

- Optional conductor outlet direction
- Stable mechanical design

Product benefits

Product benefits

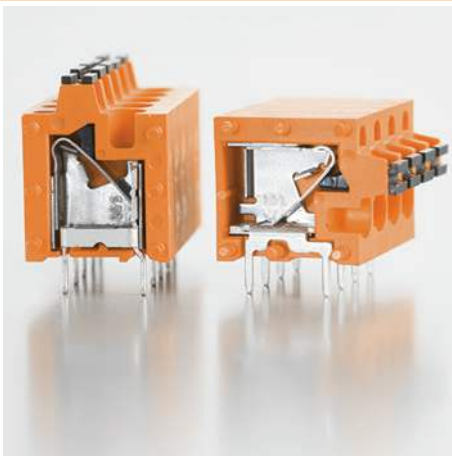

- High reliability of the current capacity

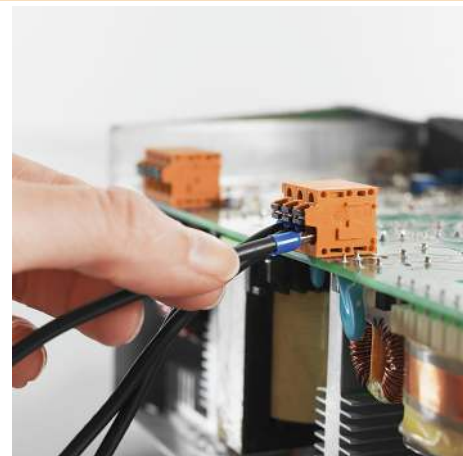

- Direct conductor entry
- Cross section up to 2.5 mm²

Data sheet**OMNIMATE Signal - series LMF
LMF 5.00/22/90 3.5SN OR BX**

Weidmüller Interface GmbH & Co. KG
Klingenbergstraße 16
D-32758 Detmold
Germany
Fon: +49 5231 14-0
Fax: +49 5231 14-292083
www.weidmueller.com

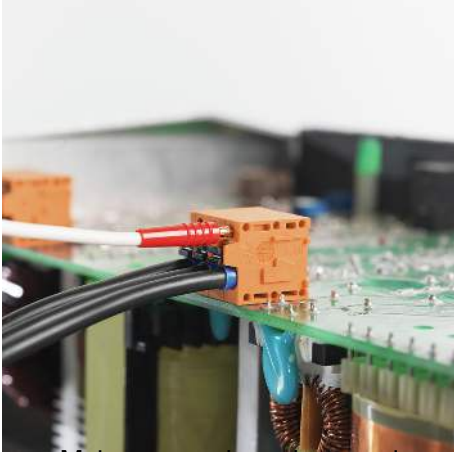
Drawings**Product benefits**

- Maintenance through test point

MASSE OHNE TOLERANZ SIND KEINE PRUEFMASSE
 DIMS. WITHOUT TOLERANCE ARE NOT CONTROL DIMS.

DIE DEUTSCHE VERSION IST VERBINDLICH
 THE GERMAN VERSION IS BINDING

ALLGEMEINGUELTIGE KUNDENZEICHNUNG, AKTUELLER STAND NUR AUF ANFRAGE
 GENERAL CUSTOMER DRAWING, TOPICAL VERSION ONLY IF REQUIRED

SHOWN: LMF 5.00/04/90 3.5

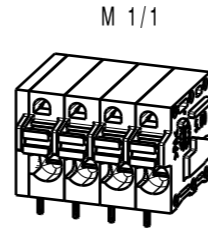
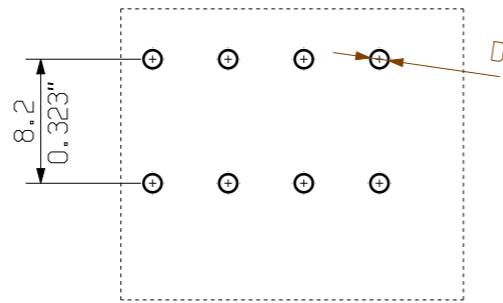
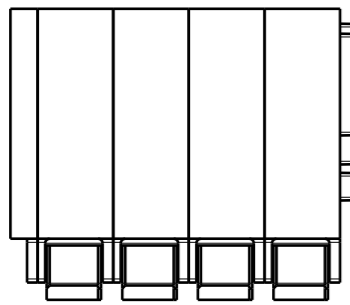
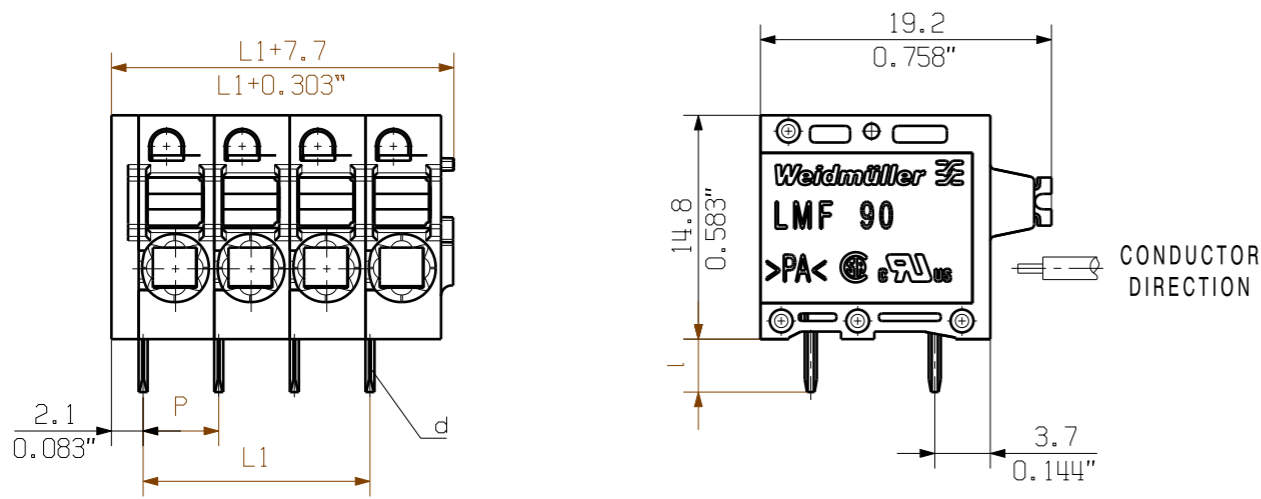

HOLE PATTERN

SHOWN: LMFS 5.00/04/90 3.5

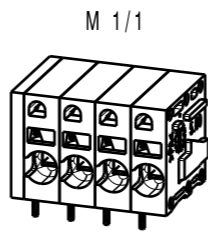
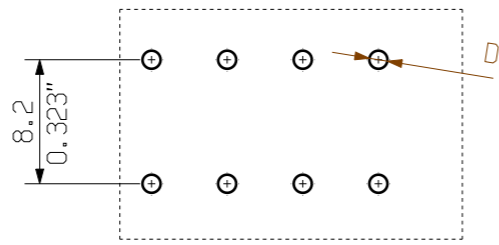
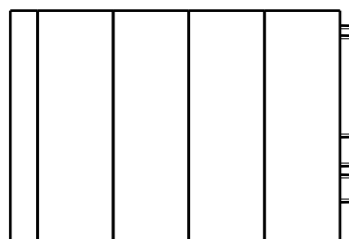
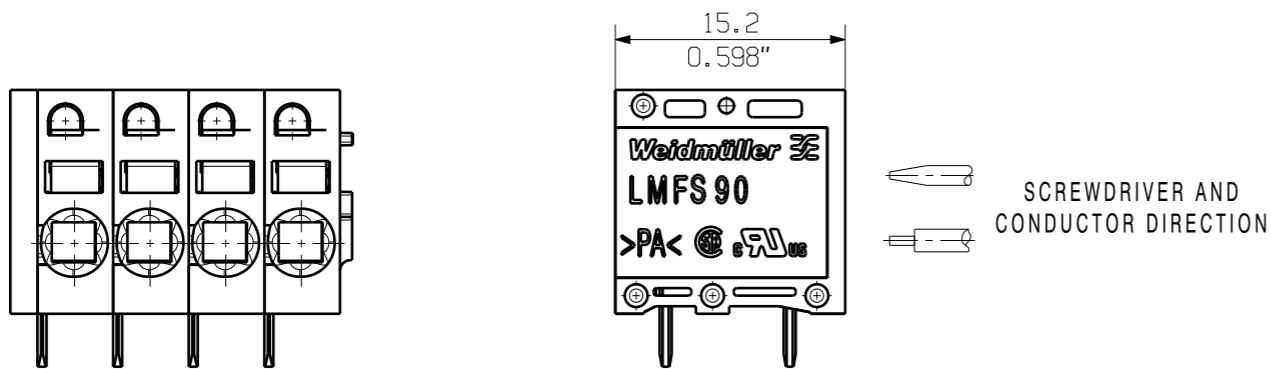

HOLE PATTERN

P = 5.00 RASTER PITCH
 D = $\varnothing 1.1 + 0.1$
 0.043"
 d = 0.6x0.8
 0.024"x0.031"
 l = 3.5
 0.138"

For the mounting of PCBs, it should be noted that the rated data relates only to the PCB components alone. The necessary creepage and clearance paths must be observed in connection with the respective applicant in accordance to IEC 664 / VDE 0110. The current-carrying capacity and pitch tolerance is to be determined according to DIN IEC 326 part 3 very fine.

Weidmüller PCB components are tested to the DIN EN 61984 standard, and are valid for its field of application. Provided that the components are used to the intended purpose, all requirements with respect to the occurring of electrical, mechanical, thermic and corrosive stress will be satisfied.

| | | |
|---------|---------|-----------|
| 24 | 115.00 | 4.528 |
| 23 | 110.00 | 4.331 |
| 22 | 105.00 | 4.134 |
| 21 | 100.00 | 3.937 |
| 20 | 95.00 | 3.740 |
| 19 | 90.00 | 3.543 |
| 18 | 85.00 | 3.346 |
| 17 | 80.00 | 3.150 |
| 16 | 75.00 | 2.953 |
| 15 | 70.00 | 2.756 |
| 14 | 65.00 | 2.559 |
| 13 | 60.00 | 2.362 |
| 12 | 55.00 | 2.165 |
| 11 | 50.00 | 1.969 |
| 10 | 45.00 | 1.772 |
| 9 | 40.00 | 1.575 |
| 8 | 35.00 | 1.378 |
| 7 | 30.00 | 1.181 |
| 6 | 25.00 | 0.984 |
| 5 | 20.00 | 0.787 |
| 4 | 15.00 | 0.591 |
| 3 | 10.00 | 0.394 |
| 2 | 5.00 | 0.197 |
| n POLES | L1 [mm] | L1 [inch] |

| | | | | | |
|--------------------------------------|--|----------------------------------|------------|---|-----------|
| GENERAL TOLERANCE: DIN ISO 2768-m | | 70657/4 26.06.13 TIELKER_S 01 | | CAT.NO.: . . . | |
| | | MODIFICATION | | | |
| | | DATE | NAME | DRAWING NO. C 55663 03 | |
| SCALE: 2/1 | | DRAWN | 25.01.2012 | REGLIN_A | ISSUE NO. |
| SUPERSEDES: . | | RESPONSIBLE | | SCHMITZ_T | |
| | | CHECKED | 26.06.2013 | HECKERT_M | |
| | | APPROVED | | HANKE_D | |
| | | | | SHEET 01 OF 01 SHEETS | |
| | | | | LMF... 5.00/.../90 ... LEITERPLATTENANSCHLUSSKLEMME PCB TERMINAL | |
| PRODUCT FILE: LMF 5.0X | | | | 7403 | |

WEITERGABE SOWIE VERVIELFÄLTIGUNG DIESES DOKUMENTS, VERWERTUNG UND MITTEILUNG SEINES INHALTS SIND VERBOTEN, SOWEIT NICHT AUSDRUECKLICH GESTATTET. ZUWIDERHANDLUNGEN VERPFLICHTEN ZU SCHADENERSATZ. ALLE RECHTE FUER DEN FALL DER PATENT-, GEBRAUCHSMUSTER-, ODER GESCHMACKSMUSTEREINTRAGUNG VORBEHALTEN. THE REPRODUCTION, DISTRIBUTION AND UTILIZATION OF THIS DOCUMENT AS WELL AS THE COMMUNICATION OF ITS CONTENTS TO OTHERS WITHOUT EXPLICIT AUTHORIZATION IS PROHIBITED. OFFENDERS WILL BE HELD LIABLE FOR THE PAYMENT OF DAMAGES. WEIDMUELLER EXCLUSIVELY RESERVES THE RIGHT TO FILE FOR PATENTS, UTILITY MODELS OR DESIGNS. © WEIDMUELLER INTERFACE GmbH & Co.KG

Recommended wave soldering profiles

Weidmüller Interface GmbH & Co. KG
 Klängenbergstraße 16
 D-32758 Detmold
 Germany
 Fon: +49 5231 14-0
 Fax: +49 5231 14-292083
 www.weidmueller.com

Single Wave:

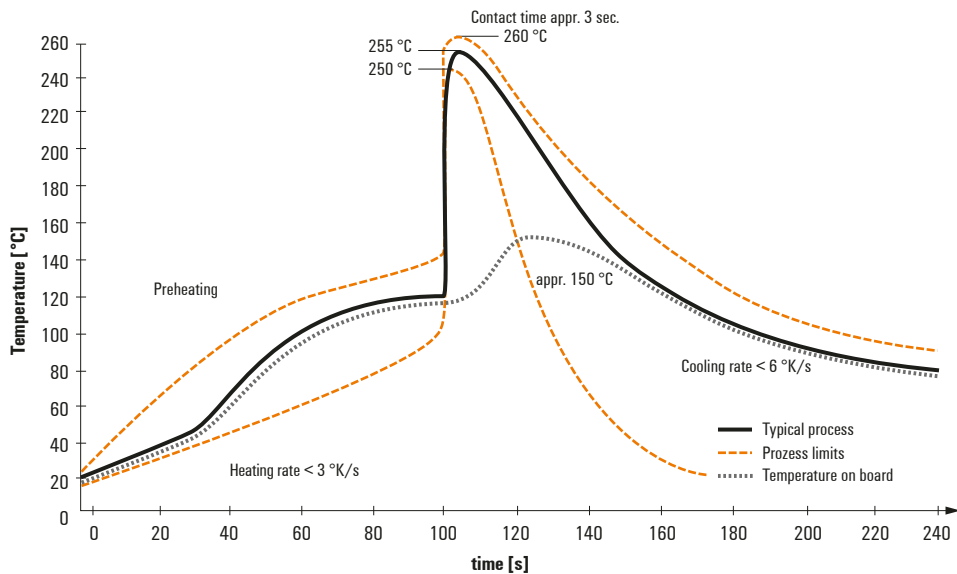

Double Wave:

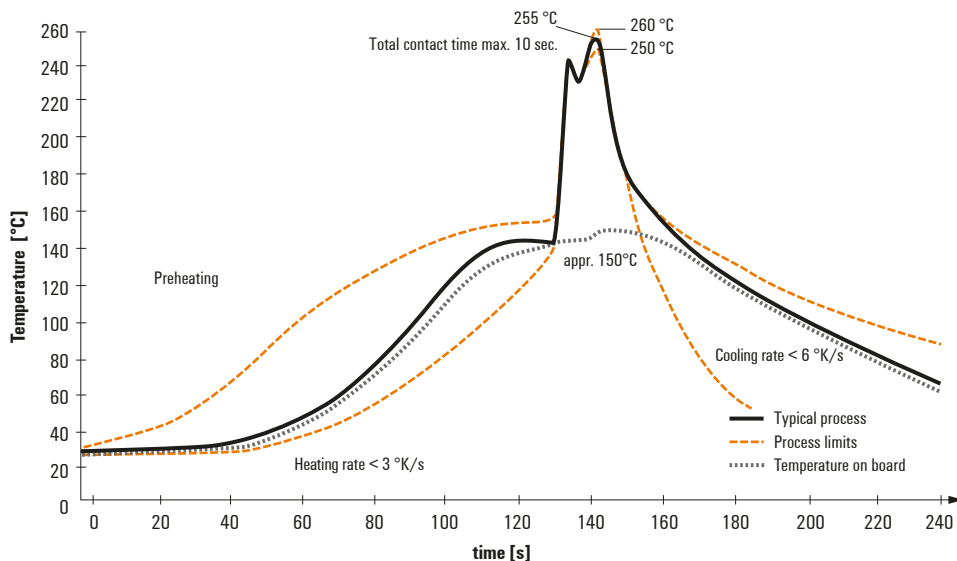

Wave soldering profiles

Wired connection elements should be processed in accordance with the DIN EN 61760-1 standard. We have included two recommendations for practical wave soldering profiles, with which Weidmüller PCB terminals and connectors are qualified.

When choosing a suitable profile for your application, the following factors also need to be considered:

- PCB thickness
- Proportion of Cu in the layers
- Single/double-sided assembly
- Product range
- Heating and cooling rates

The single and double wave profiles each indicate the recommended operating range, including the maximum soldering temperature of 260°C. In practice, the maximum soldering temperature is quite often well below the above maximum profile.