

# **M68ICS08KX**

## **In-circuit Simulator Board**

**User's Manual**



## Important Notice to Users

While every effort has been made to ensure the accuracy of all information in this document, Motorola assumes no liability to any party for any loss or damage caused by errors or omissions or by statements of any kind in this document, its updates, supplements, or special editions, whether such errors are omissions or statements resulting from negligence, accident, or any other cause. Motorola further assumes no liability arising out of the application or use of any information, product, or system described herein: nor any liability for incidental or consequential damages arising from the use of this document. Motorola disclaims all warranties regarding the information contained herein, whether expressed, implied, or statutory, *including implied warranties of merchantability or fitness for a particular purpose*. Motorola makes no representation that the interconnection of products in the manner described herein will not infringe on existing or future patent rights, nor do the descriptions contained herein imply the granting or license to make, use or sell equipment constructed in accordance with this description.

## Trademarks

This document includes these trademarks:

Motorola and the Motorola logo are registered trademarks of Motorola, Inc.

Windows and Windows 95 are registered trademarks of Microsoft Corporation in the U.S. and other countries.

Intel is a registered trademark of Intel Corporation.

Motorola, Inc., is an Equal Opportunity / Affirmative Action Employer.

For an electronic copy of this book, visit Motorola's web site at <http://mcu.motsps.com/documentation>

© Motorola, Inc., 2000; All Rights Reserved

---



---

**User's Manual — M68ICS08KX In-Circuit Simulator**

---



---

## Table of Contents

### Section 1. General Information

1.1	Introduction . . . . .	7
1.2	KXICS Components . . . . .	11
1.2.1	KXICS Hardware . . . . .	12
1.2.2	ICS Interface Software . . . . .	12
1.3	Hardware and Software Requirements . . . . .	13
1.4	Specifications . . . . .	13
1.5	About This Manual . . . . .	13
1.6	Customer Support . . . . .	13

### Section 2. Preparation and Installation

2.1	Introduction . . . . .	15
2.2	Hardware Preparation . . . . .	15
2.2.1	KXICS Limitations . . . . .	15
2.2.2	Configuring the KXICS Jumper Headers . . . . .	16
2.2.3	Installing an MCU on the KXICS . . . . .	17
2.2.4	Connecting the KXICS to the host PC. . . . .	18
2.2.5	Applying power to the KXICS. . . . .	19
2.2.6	Target Cable Interface Connection Options. . . . .	19
2.3	Target Cable Interface Connectors . . . . .	20
2.3.1	Host Computer - KXICS Interconnection J6 . . . . .	23
2.3.2	Power Connector J2 . . . . .	23
2.4	Connecting the KXICS . . . . .	24
2.5	Connecting the KXICS to the Target System. . . . .	24
2.6	Installing the Software . . . . .	25

## Section 3. Support Information

3.1	Introduction. . . . .	27
3.2	MCU Subsystem. . . . .	27
3.3	Level Translation . . . . .	28
3.4	KXICS Theory of Operation. . . . .	28
3.4.1	Power Supply . . . . .	28
3.4.2	Serial Communications . . . . .	30
3.4.3	Clock Selection . . . . .	30
3.4.4	Start-Up in Monitor Mode . . . . .	31
3.5	KXICS Connector Signal Definitions. . . . .	32
3.5.1	Target Flex Cable Interface Connector J1 . . . . .	32
3.5.2	Target Ribbon Interface Connector J5. . . . .	33
3.5.3	Target MONO8 Interface Connector J3. . . . .	34
3.5.4	Power Connector . . . . .	35
3.5.5	RS-232C Communication Connector, J6. . . . .	36
3.6	Parts List . . . . .	37
3.7	KXICS Board Layout and Schematics Diagrams. . . . .	40

## Section 4. Using the MON08 Interface

4.1	Introduction. . . . .	41
4.2	Target System Header Placement and Layout . . . . .	41
4.3	Connecting to the In-Circuit Simulator . . . . .	42

## Appendix A. S-Record Information

A.1	Introduction. . . . .	43
A.2	S-Record Contents . . . . .	43
A.3	S-Record Types. . . . .	44
A.4	S Record Creation. . . . .	45
A.5	S-Record Example . . . . .	45
A.5.1	S0 Header Record . . . . .	46

A.5.2	First S1 Record. . . . .	46
A.5.3	S9 Termination Record . . . . .	47
A.5.4	ASCII Characters . . . . .	48

## **Appendix B. Quick Start Hardware Configuration Guide**

B.1	Introduction. . . . .	49
B.1.1	KXICS Configurable Jumper Headers. . . . .	50
B.1.2	Target Interface Cable Connections. . . . .	51
B.1.3	Host Computer — KXICS Interconnection (J6) . . . . .	51
B.2	Installing the Hardware. . . . .	52
B.3	Installing the Software . . . . .	53
B.4	Connecting to a Target System. . . . .	53

## **Glossary**

# Table of Contents

**User's Manual — M68ICS08KX In-Circuit Simulator**

---

**List of Figures**

<b>Figure</b>	<b>Title</b>	<b>Page</b>
1-1	Motorola M68ICS08KX (KXICS) Board . . . . .	12
2-1	KXICS with SOIC-to-DIP Adapter . . . . .	23
2-2	Host Computer to KXICS Interconnection . . . . .	28
2-3	J2 Power Connector . . . . .	28
3-1	KXICS Board Layout . . . . .	44





---

**User's Manual — M68ICS08KX In-Circuit Simulator**

---

## List of Tables

<b>Table</b>	<b>Title</b>	<b>Page</b>
Table 1-1.	KXICS Product Components . . . . .	15
Table 1-2.	Hardware Connector Components . . . . .	16
Table 1-3.	Software Components . . . . .	16
Table 1-4.	KXICS Board Specifications. . . . .	17
Table 2-1	KXICS Jumper Header Description. . . . .	21
Table 2-2.	Cable/Connector Options for MCUs. . . . .	23
Table 2-3	J1 Pin Assignments . . . . .	24
Table 2-4	J5 Pin Assignments . . . . .	25
Table 2-5	J3 Pin Assignments . . . . .	26
Table 3-1	J1 Target Flex Connector Pin Assignments . . . . .	36
Table 3-2	J5 Target Connector Pin Assignments . . . . .	38
Table 3-3	J3 MONO8 Target Connector Pin Assignments . . . . .	39
Table 3-4	Power Connector J2 Pin Assignments . . . . .	39
Table 3-5	RS-232C Communication Connector J6 Pin Assignments . . . . .	40
Table 3-6.	KXICS Parts List (Rev F) . . . . .	41
Table 4-1.	MON08 Target System Connector J3 . . . . .	45
Table 4-2	KXICS Jumper Header Description. . . . .	54
Table 4-3	Cable/Connector Options for MCUs . . . . .	55



# Section 1. General Information

## 1.1 Introduction

This section provides general information about the Motorola M68ICS08KX in-circuit simulator (KXICS).

The KXICS board (Figure 1-1) is a stand-alone development and debugging tool. It contains the hardware and software needed to develop and simulate source code and to program Motorola's MC68HC908KX8 microcontroller (MCU).

The KXICS and its software form a complete editor, assembler, programmer, simulator, and limited real-time input/output emulator for the MCU. When connection is made between a host PC (personal computer) and target hardware (your prototype product), actual inputs and outputs of the target system may be used during code simulation.

The KXICS can interface with any IBM<sup>®</sup> Windows 95<sup>®</sup>-based computer (or later version) through connection of a single RS-232 serial port using a DE-9 serial cable.

Connection to the target system is accomplished by a ribbon cable, a Motorola M68CLB05A flex cable, or a MONO8 cable. The ribbon cable or flex cable is used when an MCU is resident on the KXICS for emulation or simulation, and the MONO8 cable is used to debug or program a target system's MCU, directly, when the MCU resides on the target hardware.

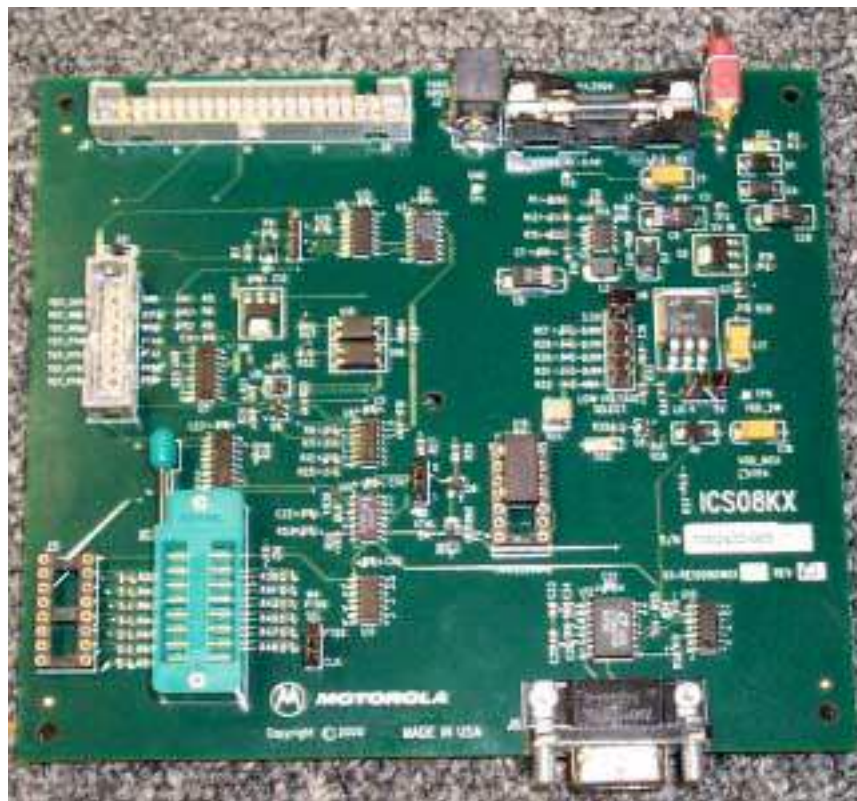

**Figure 1-1 Motorola M68ICS08KX (KXICS) Board**

The KXICS is a low-cost development system that supports editing, assembling, in-circuit simulation, in-circuit emulation, and FLASH memory programming. Its features include:

- Editing with WinIDE
- Assembling with CASM08W
- Programming FLASH memory with PROG08SZ
- Simulating in-circuit and stand-alone MC68HC908KX8 MCU with ICS08KXW software, providing:
  - Simulation of all instructions, memory, and peripherals
  - Simulation of pin inputs from the target system
  - Installation of conditional breakpoints, script files, and logfiles
- Debugging and emulation (limited real-time) with ICD08SZ, including:

- Loading code into RAM
- Executing real-time in RAM or FLASH
- Placing one hardware breakpoint in FLASH
- Placing multiple breakpoints in RAM
- On-line help documentation for all software
- Software integrated into the WinIDE environment, allowing function key access to all applications
- MON08 emulation connection to the target system allowing:
  - In-circuit emulation
  - In-circuit simulation
  - In-circuit programming
- Four modes of operation:
  - Standalone — using the KXICS as a standalone system without a target board
  - Simulation — using the KXICS as an in-circuit simulator/emulator with a target cable
  - Evaluation - using the KXICS for real-time evaluation of the MCU and to debug user developed hardware and software
  - Programming — using the KXICS as a programmer
- With the ICD08SZ debugging software, code can be run directly out of the MCU's internal FLASH at real-time speeds.
- With the WinIDE, CASM08Z, editor, simulator, and assembler software, the function is as a limited real-time emulator.
- With the PROG08SZ software, the function is to program MCU FLASH memory.
- With the ICS08KXZ simulation software, the MCU provides the required input/output information that lets the host computer simulate code, performing all functions except for maintaining port values. (The internal FLASH memory on the device is downloaded with a program that generates the appropriate port values.) The ICS08KXZ software on the host computer lets the host computer become a simulator.

## General Information

- With using the ICD08SZ debugging software, code can be run directly out of the MCU's internal FLASH at real-time speeds.
- Timing is accomplished with a 9.8304 MHz crystal

## 1.2 KXICS Components

The complete KXICS system includes hardware, software, and documentation. This section lists the KXICS product components.

**Table 1-1. KXICS Product Components**

Part Number	Description
ICS08KX	KXICS software development package
ICS08KXZ	KXICS software simulator
ICD08SZ	KXICS software debugger/emulation
MC68HC908KX8CP	MCU (16-pin DIP package)
MC68HC908KX8CDW	MCU (16-pin SOIC Package)
PA16SO-08H-3	SOIC-to-DIP Socket Adapter
M68CLB05A	Flex target cable
KRISTA 22-122	Serial cable
FRIWO 11.8999-P5	Power supply
M68ICS08SOM/D	In-circuit simulator software operator's manual
M68ICS08KXHOM/D	In-circuit simulator hardware operator's manual

## 1.2.1 KXICS Hardware

lists the KXICS hardware components.

**Table 1-2. Hardware Connector Components**

Components	Description
XU1	Test socket for the Motorola MC68HC908KX8 MCU: 16-pin DIP (dual in-line package)
J1	Two 2-row × 20-pin, 0.1-inch spacing connectors to connect the KXICS to a target using the M68CLB05A flex cable
J2	+5 Vdc input voltage ( $V_{DD}$ )
J3	One 2-row × 8-pin, 0.1-inch spacing connector to connect to a remote target via the MON08 debug circuit.
J4	J4 is the clock output that may be used for synchronizing a target or test equipment to the KXICS clock.
J5	One 2-row × 8-pin, 0.3-inch spacing dual in-line package (DIP) socket to allow the KXICS to be connected to the target using a ribbon cable
J6	RS-232 to interface KXICS to host computer serial connector (DEKL-9SAT-F)

## 1.2.2 ICS Interface Software

Windows-optimized software components are referred to, collectively, as the KXICS software (part number ICS08KX). It is a product of *P&E Microcomputer Systems, Inc.* and is included in the KXICS kit ().

**Table 1-3. Software Components**

Components	Description
WINIDE.EXE	Integrated development environment (IDE) software interface for editing and performing software or in-circuit simulation
CASM08Z.EXE	CASM08Z command-line cross-assembler
ICS08SZ.EXE	In-circuit/stand-alone simulator software for the MC68HC908KX8 MCU
PROG08SZ.EXE	FLASH memory programming software
ICD08SZ.EXE	In-circuit debugging software for limited, real-time emulation



## 1.3 Hardware and Software Requirements

The KXICS software requires this minimum hardware and software configuration:

- Windows 95 or later version operating system
- Approximately 2 Mbytes of available random-access memory (RAM) and 5 Mbytes of free disk space
- A serial port for communications between the KXICS and the host computer

## 1.4 Specifications

Table 1-4 summarizes the KXICS hardware specifications.

**Table 1-4. KXICS Board Specifications**

Characteristic	Specification
Temperature: Operating Storage	0° to 40°C -40° to +85°C
Relative humidity	0 to 95%, non-condensing
Power requirement	+5 Vdc, from included ac/dc adapter

## 1.5 About This Manual

The procedural instructions in this manual assume that the user is familiar with the Windows interface and selection procedures.

## 1.6 Customer Support

To obtain information about technical support or ordering parts, call the Motorola help desk at 800-521-6274.



## Section 2. Preparation and Installation

### 2.1 Introduction

This section provides information and instruction for configuring, installing, and readying the M68ICS08KX (KXICS) for use.

### 2.2 Hardware Preparation

**ESD CAUTION:** *Ordinary amounts of static electricity from clothing or the work environment can damage or degrade electronic devices and equipment. For example, the electronic components installed on the printed circuit board are extremely sensitive to electrostatic discharge (ESD). Wear a grounding wrist strap whenever handling any printed circuit board. This strap provides a conductive path for safely discharging static electricity to ground.*

#### 2.2.1 KXICS Limitations

These sub-paragraphs describe system limitations of the KXICS.

##### 2.2.1.1 Bus Frequency

The KXICS communicates using the MON08 features which forces the communication rate to  $f_{\text{bus}}/256$ , and the bus frequencies are limited by standard baud rates allowed by the host software.

##### 2.2.1.2 Port A0

Port A0 is used for communications, so it is unavailable for emulation.

### 2.2.1.3 Low Voltage Interrupt (LVI)

The LVI is disabled by default in monitor mode. It is enabled by a dummy write to LVISR.

### 2.2.1.4 Internal Clock Generator (ICG)

The ICG is bypassed in monitor mode, so it is not available for use.

## 2.2.2 Configuring the KXICS Jumper Headers

The KXICS supports four configuration options: standalone, simulation, evaluation, and programming.

- Standalone — ICS08KXZ.exe running on the host computer (the KXICS is not connected.) Emulation of the MCU CPU, registers, and I/O ports is done within the host computer environment.
- Simulation — Host computer is connected to the KXICS via the RS-232 cable and ICS08KXZ.exe runs on the host computer, providing access to the M68HC(9)08KX MCU CPU internal registers and I/O ports.
- Evaluation — Host computer is connected to the KXICS, and the KXICS is connected to the target system via the flex cable, providing limited real-time evaluation of the MCU and debugging user developed hardware and software.
- Programming — Host computer is connected to the KXICS, and the KXICS is connected to the target system via the MON08 cable with PROG08SZ.exe used to program the MCU FLASH module. In the programming mode there is limited evaluation (port A0 on the KX8 and port B0 and port B1 on the KX8 are used for communications, so they are unavailable for emulation).

Four jumper headers (Table 2-1) on the KXICS are used to configure the hardware options.

**CAUTION:** *The KXICS can be set to operate at a variety of voltages. When configuring the KXICS jumper headers, care must be exercised to ensure that the voltages selected for the board match those of the target device. Failure to do so can result in damage to either or both of the pieces of equipment.*

**Table 2-1 KXICS Jumper Header Description**

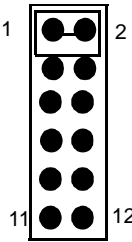
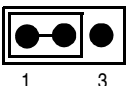
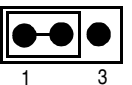
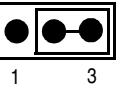
Jumper Header	Type (Factory Default Shown)	Description
W1 Low Voltage Select		Used to set power for the MCU to match various target voltages. (No default) Jumper on position 1 & 2: 3.3 V Jumper on position 3 & 4: 3.0 V Jumper on position 5 & 6: 2.7 V Jumper on position 7 & 8: 2.2 V Jumper on position 9 & 10: 2.0 V Jumper on position 11 & 12: ADJ
W2 MCU Voltage Select		Selects voltage powering MCU and related circuitry. Jumper on position 1&2: Regulator Lo V as set by W1, is supplied by MCU. Labeled LO V. Jumper on position 3&2: Power supply, 5V Switched, is supplied by board to MCU. Labeled 5V.
W3 Target Clock Select		Jumper on position 1&2: supplies KXICS, 9.8304 MHz, clock, to MCU and target via W4. Jumper on position 3&2: disables Xtal clock output, which will affect the power-up reset. Labeled 1.
W4 PTB6 Select		Jumper on position 1&2: MCU's internal clock is supplied to target cable via PTB6. Jumper on position 3&2: KXICS Xtal clock is supplied to MCU.

### 2.2.3 Installing an MCU on the KXICS

Either of two types of MCUs may be installed on the KXICS board, a DIP-type or a SOIC-type.

#### 2.2.3.1 DIP-type MCU

1. Place the pin tension arm of the KXICS DIP socket XU1 in the up position.
2. Install the DIP type MCU into the DIP socket XU1. Be sure that the pin 1 orientation of the silkscreened dot on the MCU aligns with the pin 1 location on the DIP socket (upper left pin of the socket).

3. Place the pin tension arm of the KXICS DIP socket XU1 in the down position to secure the pins of the MCU to the socket.

**NOTE:** *The top (label side) of the MCU package must be visible when looking at the component side of the board.*

### 2.2.3.2 SOIC-type MCU

**NOTE:** *Installation of a SOIC type MCU requires the use of the SOIC-to-DIP adapter identified in Table 1-1 of this manual.*

1. Place the pin tension arm of the KXICS DIP socket XU1 (Figure 2-1) in the up position.
2. Install the SOIC-to-DIP adapter into the DIP socket XU1 (Figure 2-1). Be sure that the pin 1 orientation of the adapter aligns with the pin 1 location on the DIP socket (upper left pin of the DIP socket).

**CAUTION:** *The SOIC-to-DIP adapter may be confusing to install. It must be placed into the DIP socket, XU1, with the hinged side of the SOIC shell aligned to the bottom of the KXICS board. This positioning will place the SOIC-type MCU socket pin 1 in the upper left corner of the SOIC socket.*

3. Place the pin tension arm of the KXICS DIP socket XU1 in the down position to secure the pins of the adapter to the socket.
4. Open the hinged access door on the SOIC shell.
5. Install the SOIC-type MCU into the SOIC socket of the adapter. Be sure that the pin 1 orientation of the silkscreened dot on the MCU aligns with the pin 1 location on the SOIC socket (upper left pin of the socket).
6. Close and secure the hinged access door on the SOIC shell.

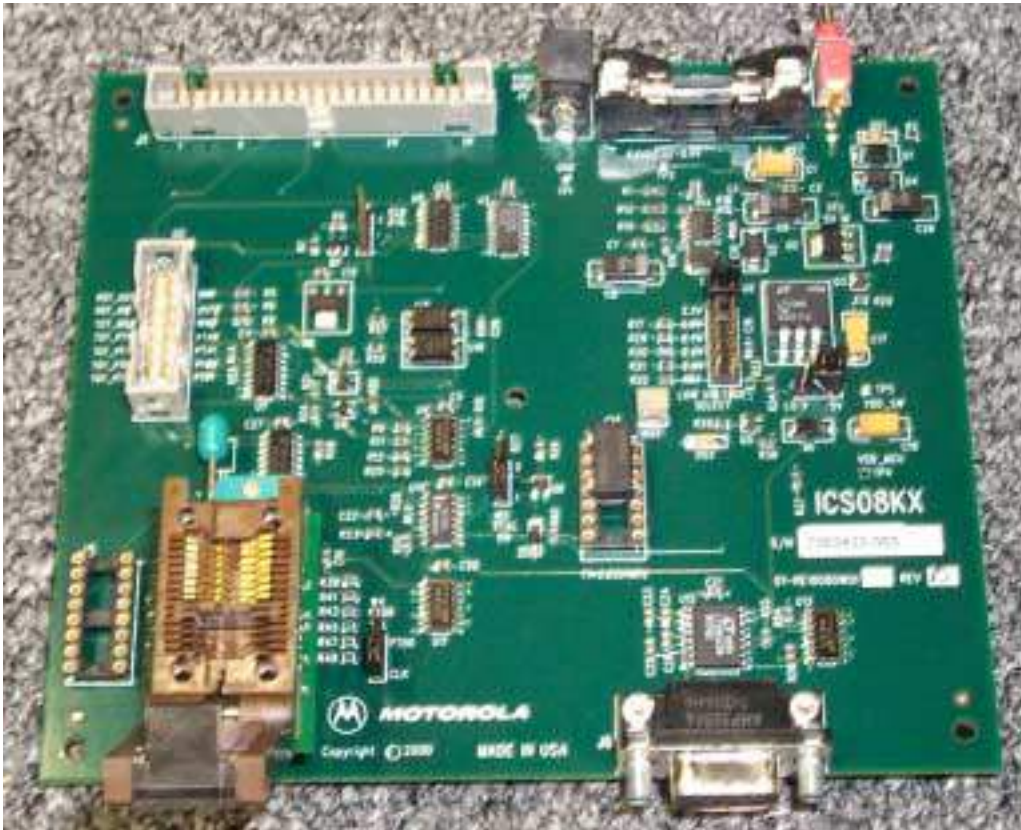

Figure 2-1 KXICS with SOIC-to-DIP Adapter

#### 2.2.4 Connecting the KXICS to the host PC.

Locate the 9-pin connector labeled J6 on the board. Using the cable provided, connect it to a serial COM port on the host PC.

#### 2.2.5 Applying power to the KXICS.

**CAUTION:** *Although applying power is described here, do not apply power until all other configuring, installing, and cable connections are completed. Equipment damage can result.*

Connect the 5-volt power supply to the round connector on the board, J2. Plug the power supply into an ac power outlet, using one of the country-specific adapters provided. (The KXICS green power LED on the board lights when switch SW1 is in the ON position.)

### 2.2.6 Target Cable Interface Connection Options

There are three ways to connect the KXICS simulator board to your target system:

- Flex cable — low-noise target interface connection (may be ordered separately)
- Ribbon cable — low-cost target interface connection
- MON08 cable — target interface connection with MCU FLASH programming and limited emulation

Below (Table 2-2) is a quick reference for defining the cable/connector selection to use with the MC68HC908KX8. Select the option that meets your requirements and connect accordingly.

**Table 2-2. Cable/Connector Options for MCUs**

MCU	Flex Cable	Ribbon Cable	MON08 Cable
MC68HC908KX8	J1	J5	J3



## 2.3 Target Cable Interface Connectors

**NOTE:** Refer to Section 3, Support Information for more detail.

### 2.3.0.1 Target Flex Cable Interface Connector J1

The flex cable is a low-noise alternative connection that may be used to connect to the target. Table 2-3 shows the pin assignments for flex cable connector J1.

**Table 2-3 J1 Pin Assignments**

J1					
N/C	1	•	•	2	N/C
N/C	3	•	•	4	PTB7
N/C	5	•	•	6	PTB6
N/C	7	•	•	8	PTB5
N/C	9	•	•	10	PTB4
N/C	11	•	•	12	N/C
N/C	13	•	•	14	PTB3
TGT_PTA0	15	•	•	16	PTB2
TGT_PTA1	17	•	•	18	TGT_PT B1
TGT_PTA2	19	•	•	20	TGT_PT B0
TGT_PTA3	21	•	•	22	N/C
TGT_PTA4	23	•	•	24	N/C
N/C	25	•	•	26	IRQ*
N/C	27	•	•	28	N/C
Common	29	•	•	30	Common
Common	31	•	•	32	Common
Common	33	•	•	34	Common
Common	35	•	•	36	Common
Common	37	•	•	38	Common
Common	39	•	•	40	Common

## 2.3.0.2 Target Ribbon Interface Connector J5

The KXICS includes a connector, J5 (Table 2-4), which allows a convenient, less-expensive connection to the target, using a 16-pin ribbon cable.

**Table 2-4 J5 Pin Assignments**

		J5			
Common	1	•	•	16	N/CPTA1
PTA1	2	•	•	15	PTA4
PTA0	3	•	•	14	PTA3
IRQ*	4	•	•	13	PTA2
PTB0	5	•	•	12	PTB4
PTB1	6	•	•	11	PTB6
PTB2	7	•	•	10	OSC1/PTA3
PTB3	8	•	•	9	PTB7

### 2.3.0.3 Target MONO8 Interface Connector J3

The MONO8 interface connector, J3 (Table 2-5), is used when the MCU is mounted on the target. Refer to Section 4 *Using the MONO8* for detailed information.

**Table 2-5 J3 Pin Assignments**

		J4			
RST_OUT*	1	●	●	2	Common
RST_IN*	3	●	●	4	RST*
TGT_IRQ*	5	●	●	6	IRQ*
TGT_PTA0	7	●	●	8	PTA0
TGT_PTA1	9	●	●	10	PTA1
TGT_PTB0	11	●	●	12	PTB0
TGT_PTB1	13	●	●	14	PTB1
N/C	15	●	●	16	N/C

## 2.3.1 Host Computer - KXICS Interconnection J6

The host computer to KXICS interface is via the single system connector J6, which is a 9-pin, D-type connector (Amp part number AMP-9726-A) (Figure 2-2), mounted on the top side of the board.

Connection requires the cable assembly supplied with your KXICS kit, a DB9-male-to-female, 6-ft. (3 m) long serial cable.

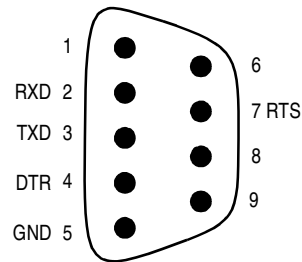

**Figure 2-2 Host Computer to KXICS Interconnection**

## 2.3.2 Power Connector J2

Connect +5-Vdc power directly to the KXICS via connector J2 (Figure 2-3) using the provided power supply.

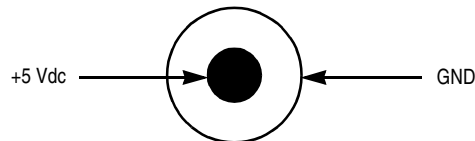

**Figure 2-3. J2 Power Connector**

## 2.4 Connecting the KXICS

The following steps provide instructions for connecting the KXICS to the host PC and power connection.

**ESD CAUTION:** *Ordinary amounts of static electricity from clothing or the work environment can damage or degrade electronic devices and equipment. For example, the electronic components installed on the printed circuit board are extremely sensitive to electrostatic discharge (ESD). Wear a grounding wrist strap whenever handling any printed circuit board. This strap provides a conductive path for safely discharging static electricity to ground.*

- a. Configure the jumpers W-1 through W-4 on the KXICS for your application.
- b. Install an MCU into the appropriate socket, XU1, on the KXICS board.

**NOTE:** *Observe the pin 1 orientation with the silkscreened dot. The top (label side) of the MCU package must be visible when looking at the component side of the board.*

- c. Plug the serial cable into J6 on the KXICS.
- d. Plug the serial cable into the COM port on the host PC.

**NOTE:** *Steps e. through g. should not be completed until all connections to the target are completed (Paragraph 2.5).*

- e. Connect the power cable to J2 on the KXICS board.
- f. Plug the power cable into an ac power outlet, using one of the country-specific adapters.
- g. The KXICS power LED lights green.

## 2.5 Connecting the KXICS to the Target System

Connect the KXICS to the target system using one of these methods:

- Emulating using a flex cable for low-noise

When emulating, connect the 40-pin M68CLB05A flex cable to the connector labeled J1 on the simulator board. Attach the other end of the cable to the appropriate connector on the target system. Target head adapters are available.

- Emulating using a ribbon cable

When emulating, connect a 16-pin flat ribbon cable to connector J5 on the simulator board. Attach the other end of the cable to the appropriate connector on the target system.

- Using a MON08 cable to debug the target system.

**NOTE:** *An MCU must be installed in the target system. No MCU should on the KXICS.*

Connect the MON08 debug interface cable to the appropriate MON08 debug interface connector, J3, for communication with the target system's MCU. Attach the other end of the cable to the appropriate connector on the target system.

**NOTE:** *For more detailed information on the MON08, refer to Section 4 of this manual.*

## 2.6 Installing the Software

For instructions for installing the ICS08 software, refer to *P&E Microcomputer Systems, Inc., M68ICS08 68HC08 In-Circuit Simulator Operator's Manual*, Motorola document order number M68ICS08OM/D.

## Section 3. Support Information

### 3.1 Introduction

This section includes data and information that may be useful in the design, installation, and operation of your application.\

### 3.2 MCU Subsystem

The MCU subsystem consists of the MC68HC908KX8 microcontroller, clock generation and selection, monitor mode control logic that places and holds the KXICS in monitor mode, the bus voltage level translation buffers, and processor operating voltage variable regulator.

The MCU, an MC68HC908KX8, is available in two different packages:

- 16-pin SOIC (small-outline integrated circuit)
- 16-pin DIP (dual inline pack)

Only one socket may be used at a time.

Depending on the connection, the MCU is used in one of three operating modes:

- In the KXICS socket for programming and simple simulation
- In the KXICS socket and connected to the target for emulation
- On the target for MON08 debug operation

### 3.3 Level Translation

**NOTE:** *For the following discussion on the theory of operation of the KXICS, refer to the schematic diagrams in Paragraph 3.6, Figures 3-1 to 3-6 of this section.*

The KXICS has an operation voltage range of +2.0 to +5.0 volts while the host development system interface is an RS-232 (COM) port. U12 on the ICS converts 5-volt logic signals to RS-232 levels. ICS U10–U13 translate 5-volt logic levels to the MCU operating voltage (2.0–3.3 volts).

### 3.4 KXICS Theory of Operation

**NOTE:** *For the following discussion on the theory of operation of the KXICS, refer to the schematic diagrams in Paragraph 3.7.*

#### 3.4.1 Power Supply

Power input, J2, to the KXICS is via a standard DC power receptacle with a 2.5mm center pin. Input voltage is 5Vdc provided by a plug in the DC power adapter.

The power is fused to prevent catastrophic failure by fuse F1 (5x20mm or 3AG fuse).

**CAUTION:** *Always use a fuse of the proper current and voltage rating. Failure to do so can result in serious equipment damage*

In addition, the input line has a Transient Voltage Suppression (TVS) diode to stop high voltage transients, including ESD events, from damaging the board.

A green LED is provided to indicate that 5VDC is being provided to the board, with the ON/Off switch in the ON position. Power, however, is not available to



the rest of the board until the signal DTR is active high on pin 4 of the serial connector, J6.

Test points are provided for common (TP1), power input  $V_{DD}$  (TP3), switched main power  $V_{DD\_SW}$  (TP5), power to the MCU  $V_{DD\_MCU}$  (TP4), and  $V_{TST}$  (TP2).

### 3.4.1.1 Main Switched Power

Power to the MCU sockets and circuitry is switched on and off using the DTR signal into the serial interface (J6). When DTR is low, the power to the MCU socket is off, and the amber LED is off. When DTR is asserted high, transistor Q3 will turn on FET Q2 which provides power to the MCU circuitry. If W2 is selected positions 1 and 2,  $V_{TST}$  voltage is sent to the MCU along with the reset signal being held low briefly following power-up. The MCU is forced to power-up in the Monitor Mode.

**NOTE:** *The source of power for the MCU is selected by jumper2. Refer to Section 2, Table 2-1.*

The amber LED, DS2, lights when there is power to the MCU socket.

**CAUTION:** *There is no over-current protection on the board protecting against catastrophic failures if the MCU is powered from the target. Equipment damage can result.*

The power to the MCU is selected by jumper W2. With the jumper in the 5V position, the MCU will be powered by the 5V circuitry, i.e., from the plug in the power supply). With W2 in the LO V position, the MCU will be powered by the on-board low voltage regulator (U6). The low voltage is selected by jumper W1 which has preset voltages of 3.3V, 3.0V, 2.7V, 2.2V, 2.0V, and a potentiometer for adjusting the voltage.

**CAUTION:** *The MCU may be set to operate at a variety of voltages. Ensure the selected voltage matches the voltage of the target. Failure to do so can result in equipment damage.*

### 3.4.1.2 $V_{TST}$ Power

$V_{TST}$  is created by a voltage regulator, MC34063, nominally set for 8.6VDC. This keeps the worst case voltage at greater than  $V_{DD} + 3VDC$ , meeting  $V_{TST}$  voltage minimums. The voltage may be monitored at  $V_{TST}$  test point TP2.

$V_{TST}$  is used during start-up to force the MCU into the Monitor Mode.

### 3.4.1.3 Reset on Power-up

At initial power-on to the MCU, there is a delay of a few hundred milliseconds during which the signal ICS\_RST# is held low, as set by U8 (DS1233).

When ICS\_RST# goes high, the binary ripple counter, U3, begins counting clock cycles, at the 9.8304MHz rate of the clock Y1. After 1024 clock cycles are counted, the DELAY\_RESET signal toggles and the counter stops counting. The delayed reset signal is used to turn-on communications to the MCU and to hold several MCU pins in appropriate states to force Monitor Mode on power-up.

## 3.4.2 Serial Communications

Serial communication in half-duplex mode, using PTA0 for transmit and receive, to the MCU is via the DE9 connector, J6. Pin 2 is the path for transmit signals and pin 3 is for receive signals. Pin 4, the DTR signal, is utilized as an input to provide the software host with the ability to turn MCU power on and off. The RTS signal on contact 7 is used as an input to provide the software host with the ability to control the IRQ\* high voltage.

Serial communication to the MCU does not occur until DELAY\_RESET becomes active high 1024 clock cycles after the RESET signal is high (para 3.4.1.3).

## 3.4.3 Clock Selection

The source of timing for the MCU may be either the KXICS board's clock Y1 or the MCU'S internal clock. Selection is by jumper header W-4 (Table 2-1).

When the jumper is set for the PTB6 position, the MCU runs from its internal clock and pin PTB6 of the MCU is connected to the target connector.

When the jumper is set for the CLK position, the Y1 external clock signal from the KXICS board is applied to the PTB6 pin of the MCU for timing. (An internal MCU register must be set to control the selection of internal or external clock.)

The external clock, Y1, has an output frequency of 9.8304 MHz to allow the MCU to communicate at 9600 baud. It is socketed to allow the use of a full-size or half-size clock. You may change clock frequencies by installing a new clock chip, however the serial communication rate proportionally changes. W3 may be used to disable the external clock.

Additionally, the on-board clock is available as an output on the 3-pin header J4 for target or computer host clock synchronization.

### 3.4.4 Start-Up in Monitor Mode

Following power up the ICS\_RST# is held low for a period of time by U8. When ICS\_RST\* is asserted high, the binary ripple counter, U3, counts up 1024 clock cycles prior to allowing DELAY RESET to be asserted. The delayed reset controls the analog switch, U7, connected to PTA1 and PTB[0...1]. The RTS signal is held high which places the  $V_{TST}$  voltage as the high voltage for IRQ\*.

Analog switch, U7, connects PTA1 to common, PTB0 to  $V_{DD\_MCU}$ , and PTB1 to common until DELAY\_RESET is asserted.  $V_{TST}$  is held above  $V_{DD\_MCU} + 3V_{dc}$  during the reset release forcing the KXICS board to power up in the Monitor Mode.

Following the counter time-out, the analog switch, U7, is toggled so that the PTA1 and PTB[0...1] pins of the board are connected to the target head connectors.

Following entry into monitor mode, you may switch the IRQ\* voltage to  $V_{DD\_MCU}$  by setting RTS low. The analog switch, U14, will switch the connection of MCU pin 9 from the ICS reset circuitry to a connection to the target head connector. Be aware that beside disabling the use of external resets of the MCU, internal MCU features, e.g., the COP must be serviced properly in this mode.

## 3.5 KXICS Connector Signal Definitions

The tables in this section describe the pin assignments for the connectors on the KXICS board.

### 3.5.1 Target Flex Cable Interface Connector J1

**Table 3-1 J1 Target Flex Connector Pin Assignments**

Pin No.	Schematic NET	Direction	Signal Description
1	N/C		
2	N/C		
3	N/C		
4	PTB7	Bidirectional	Port B I/O
5	N/C		
6	PTB6	Bidirectional	Port B I/O
7	N/C		
8	PTB5	Bidirectional	Port B I/O
9	N/C		
10	PTB4	Bidirectional	Port B I/O
11	N/C		
12	N/C		
13	N/C		
14	PTB3	Bidirectional	Port B I/O
15	TGT_PTA0	Bidirectional	Port A I/O
16	PTB2	Bidirectional	Port B I/O
17	TGT_PTA1	Bidirectional	Port A I/O
18	TGT_PTB1	Bidirectional	Port B I/O
19	PTA2	Bidirectional	Port A I/O
20	TGT_PTB0	Bidirectional	Port B I/O
21	PTA3	Bidirectional	Port A I/O
22	N/C		

<b>Pin No.</b>	<b>Schematic NET</b>	<b>Direction</b>	<b>Signal Description</b>
23	PTA4	Bidirectional	Port A I/O
24	N/C		
25	N/C		
26	N/C		
27	N/C		
28	N/C		
29	Common		
30	Common		
31	Common		
32	Common		
33	Common		
34	Common		
35	Common		
36	Common		
37	Common		
38	Common		
39	Common		
40	Common		

## 3.5.2 Target Ribbon Interface Connector J5

The KXICS includes a connector, J5 (Table 3-2), which allows a convenient connection to the target, using a 16-pin ribbon cable.

**Table 3-2 J5 Target Connector Pin Assignments**

Pin No.	Schematic NET	Direction	Signal Description
1	Common		
2	PTA1	Bidirectional	Port A I/O
3	PTA0	Bidirectional	Port A I/O
4	IRQ*	In	Target interrupt request to MCU
5	PTB0	Bidirectional	Port B I/O
6	PTB1	Bidirectional	Port B I/O
7	PTB2	Bidirectional	Port B I/O
8	PTB3	Bidirectional	Port B I/O
9	PTB7	Bidirectional	Port B I/O
10	OSC1/PTB6	Bidirectional	Clock signal from xtal or MCU/Port B I/O
11	PTB5	Bidirectional	Port B I/O
12	PTB4	Bidirectional	Port B I/O
13	PTA2	Bidirectional	Port A I/O
14	PTA3	Bidirectional	Port A I/O
15	PTA4	Bidirectional	Port A I/O
16	VDD		KXICS Supply Voltage

### 3.5.3 Target MONO8 Interface Connector J3

The MONO8 interface connector, J3 (Table 2-6), is used when the MCU is mounted on the target. Refer to Section 4 *Using the MONO8* for detailed information.

**Table 3-3 J3 MONO8 Target Connector Pin Assignments**

Pin No.	Schematic NET	Direction	Signal Description
1	RST_OUT*	Out	To reset target
2	Common		
3	RST_IN*	In	From target to reset MCU and Ripple Counters
4	RST*	Out	Forced reset to target
5	TGT_IRQ*	In	Target Interrupt request to MCU
6	IRQ*	Out	Interrupt Request
7	TGT_PTA0	Bidirectional	Port A I/O - bit 0
8	PTA0	Bidirectional	Port A I/O - bit 0
9	TGT_PTA1	Bidirectional	Port A I/O - bit 1
10	PTB1	Bidirectional	Port B I/O - bit 1
11	TGT_PTBO	Bidirectional	Port B I/O - bit 0
12	PTB0	Bidirectional	Port B I/O - bit 0
13	TGT_PTBO	Bidirectional	Port B I/O - bit 1
14	PTB1	Bidirectional	Port B I/O - bit 1
15	No connect		
16	No connect		

### 3.5.4 Power Connector

Power connector, J2, (Table 3-4) is used to connect to a source power supply for the KXICS.

**Table 3-4 Power Connector J2 Pin Assignments**

Pin No.	Mnemonic	Signal
1	VCC	+5 VDC POWER — Input voltage (+5 Vdc @ 1.0 A) from the provided power supply used by the KXICS logic circuits

## 3.5.4 Power Connector

Power connector, J2, (Table 3-4) is used to connect to a source power supply for the KXICS.

**Table 3-4 Power Connector J2 Pin Assignments**

Pin No.	Mnemonic	Signal
2	GND	Common
3	GND	Common

## 3.5.5 RS-232C Communication Connector, J6

The RS-232C Communication Connector, J6, (Table 3-5) provides connection to the host computer.

**Table 3-5 RS-232C Communication Connector J6 Pin Assignments**

Pin No.	Mnemonic	Signal
2	RXD	RECEIVE DATA — Output for sending serial data to the DTE device
3	TXD	TRANSMIT DATA — Input for receiving serial data output from the DTE device
4	DTR	DATA TERMINAL READY — Switches the KXICS to apply power to the MCU and related circuitry
5	GND	Common
7	RTS	Controls whether voltage for IRQ* high is $V_{TST}$ or $V_{DD\_MCU}$ .



### 3.6 Parts List

**Table 3-6. KXICS Parts List (Rev F)**

Reference Designator	Description	Manufacturer	Part Number
	Printed Circuit Board Assembly		01-RE10080W01
	Test Procedure, ICS08KX		12ASE10080W
	Test Fixture, ICS08KX		81ASE10080W
	Printed Wiring Board, ICS08KX		84-RE10080W01
	Feet Rubber 0.5" Tapered squares	FASTEX	4009-00-5072
C8, C9, C28	Cap 47 uF Tantalum low ESR 16V	AVX	TPSD476M016R0150
C2-C7,C11-C16, C19-C27	Cap 0.2 uF Ceramic Z5U 50V 0805	AVX	08055E104ZAT2A
C1, C17, C18	Cap 10 uF Tantalum 16V	AVX	TAJC106M016
C10, C29	Cap 560 pF Ceramic COG 50V 0805	AVX	08055A561KAT2A
D3, D4	Diode, Schottky, MBRA130	Motorola/ON Semi	MBRA130
D1, D5	Diode, TVS, 1SMA6.OAT3	Motorola/ON Semi	1SMA6.OAT3
D2, D6	Diode, Schottky, MBR0520	Motorola/ON Semi	MBR0520
DS1	LED Green, LED_1206	Lumex	SML-LX1206GC
DS2	LED Amber, LED_1206	Lumex	SML-LX1206YC
F1	Fuse 0.5A 250V 5x20mm Fast	Schurter	0034.1523
J2	Conn Pwr Jack RT ANG 2.5mm Center Pin	CUI Stacck	PJ-202B
J6	Conn DE9, Socket, R/A	Cinch	DEKL-9SATI-F
J4, W2-W4	Hdr, 3x1, 100, JPR_3	3M	2403-6112TB
J3	Hdr, 8x2, 100, SHRD	3M	2516-6002-UG
J1	Hdr, 2x20, 0.100.SHRD	3M	2540-6002-UG
J5	SKT 16 Pin DIP	Augat	816-AG11D
L2	IND, 180uH, SMT	Murata	LQH4N181K04
L1	ind, 10uH, SMT	Murata	LQH1N100K04
Q2	XSTR PFET MMFT5P02 SOT223	Motorola/ON Semi	MMFT5P02HD

**Table 3-6. KXICS Parts List (Rev F)**

Reference Designator	Description	Manufacturer	Part Number
Q3, Q5-6	XSTR NPN MMBT3904 SOT23	Motorola/ON Semi	MMBT3904
Q1, Q4	XSTR PFET MMBF0201 SOT23	Motorola/ON Semi	MMBF0201
R16	Res, 150 ohm, 1%, 0805	Dale	CRCW08051500F
R34	Res, 124 ohm, 1%, 0805	Dale	CRCW08051240F
R33	Res, 205 ohm, 1%, 0805	Dale	CRCW08052050F
R32	Res, 75 ohm, 1%, 0805	Dale	CRCW080575R0F
R17, R23	Res, 1.21K, 1%, 0805	Dale	CRCW08051211F
R29	Res, 499 ohm, 1%, 0805	Dale	CRCW08054990F
R30	Res, 169 ohm, 1%, 0805	Dale	CRCW08051690F
R32	Res, 118 ohm, 1%, 0805	Dale	CRCW08051180F
R1, R13, R15	Res, 10 ohm, 1%, 1206	Dale	CRCW120610R0F
R25	Res, 100k, 5%, 0805	Dale	CRCW0805104J
R26, R38-R49, R51	Res, 33 ohm, 5%, 0805	Dale	CRCW08055330J
R2, R7, R22	Res, 3.3K, 5%, 0805	Dale	CRCW0805332J
R18	Res, 59K ohm, 1%, 0805	Dale	CRCW08055902F
R4-R6, R8-R12, R14, R19-R21, R24, R27, R28, R36, R37, R50, R54-R56, R58-R59	Res, 10 K ohm, 5%, 0805	Dale	CRCW0805103J
R3, R35, R52, R57	Res, 470 ohm, 5%, 0805	Dale	CRCW0805471J
R53	Res, 330 ohm, 5%, 0805	Dale	CRCW0805331J
R60	Res, 33K ohm, 5%, 0805	Dale	CRCW0805333J
RV1	Res, VAR 2K SMT_4MM	Bourns	3214W-202W
SW1	Switch, SPDT RT ANG	C & K	ET01MD1AVQE
U4, U11, U13	IC Hex Inverter OC 74HC05 14SOIC	Motorola/ON Semi	MC74HC05D
U8	IC 5V Supervisor SOT-223	Dallas Semi	DS1233Z-5
U1	IC Microcontroller KX8 DIP16	Motorola	PC68HC908KX8DW
U2	IC UHS 2 Input OR SOT23-5	Fairchild	NC7SZEW5

**Table 3-6. KXICS Parts List (Rev F)**

<b>Reference Designator</b>	<b>Description</b>	<b>Manufacturer</b>	<b>Part Number</b>
U7, U14	IC Triple 2:1 Analog MUX 16SOIC	Motorola/ON Semi	MC74HC4053D
U9	IC Quad Nand 14SOIC	Motorola/ON Semi	MC74ACOOD
U10	IC Buffer Tri-State 14SOIC	Fairchild	MC74ACT1125D
U5	IC DC-DC Converter SO-8	Motorola/ON Semi	MC34063AD
U6	IC Var Regulator LT1086 DD_PACK	Linear Tech.	LT1086CM
U12	IC Low Power RS232 Driver 16SOIC	Linear Tech	LT1181ACSW
U15-16	Optocoupler 50% CTR DIP-4 PS2501-1	NEC	PS2501-1
W1	Hdr 2x6 0.100 JPR_2X6	3M	1412-6122TB
XF1	Holder Fuse 5x20 & 3AG	Schurter	OGD 0031.8231
XU1	SKT AIP 16 POS DIP	3M Textool	216-3340-00-0602JJ
XW1-XW4	Shunt w/Handle	AMP	881545-1
XY1	SKT 14 pin DIP	Augat	814-AG11D
Y1	Xtal, 9.8304Mhz, 1/2 size DIP	Epson	SG-532P-9.8302MC

### 3.7 KXICS Board Layout and Schematics Diagrams

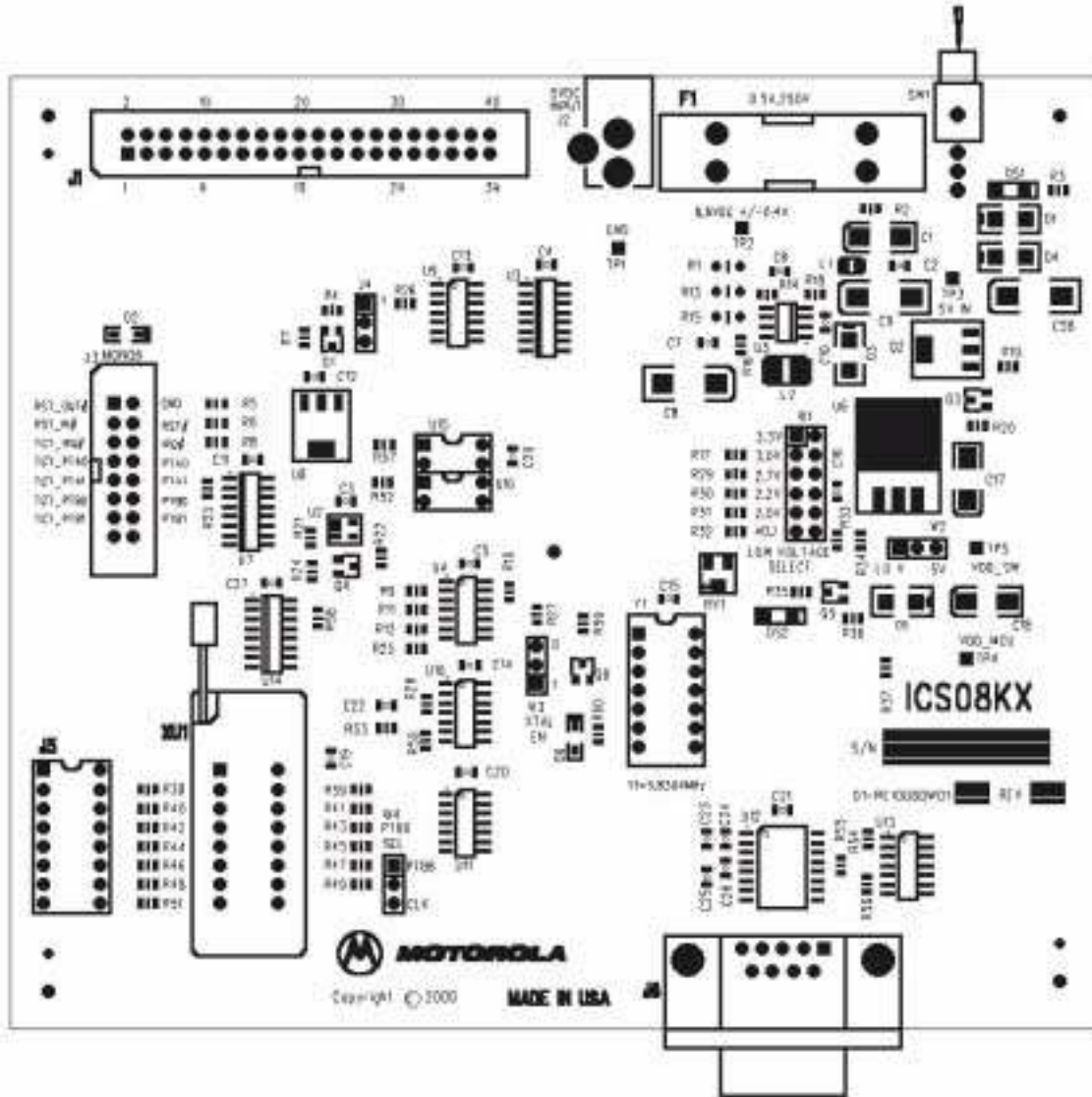
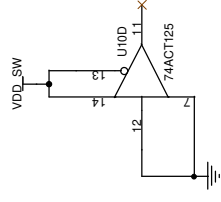
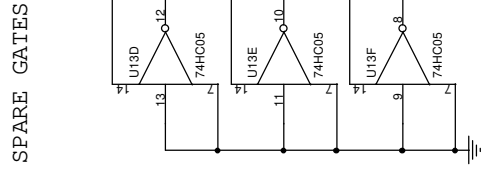
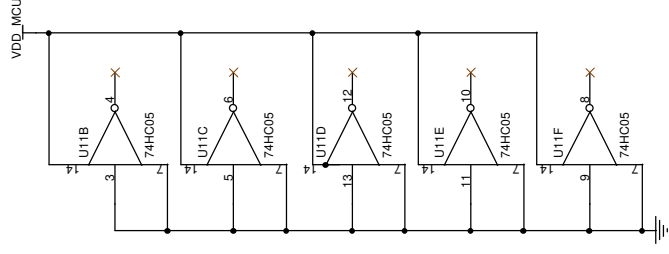
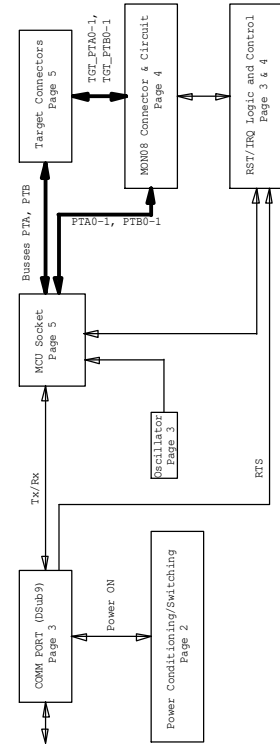

Figure 3-1 KXICS Board Layout

**NOTES:**

- UNLESS OTHERWISE SPECIFIED:  
RESISTORS ARE IN OHMS, 5%, 1/10W  
CAPACITORS ARE IN MICROFARADS, 50V
- DEVICE TYPE NUMBER IS FOR REFERENCE  
ONLY. THE NUMBER VARIES WITH THE  
PART MANUFACTURER.
- SPECIAL SYMBOL USAGE:  
# DENOTES ACTIVE LOW SIGNAL.  
[ ] DENOTES VECTORED SIGNAL.
- INTERPRET DIAGRAM IN ACCORDANCE WITH  
ANSI SPECIFICATIONS WITH THE  
EXCEPTION OF LOGIC BLOCK SYMBOLLOGY.



REV	DESCRIPTION	DATE	ENG
B0.0	Initial Concepts	TBD	
0	Ready for Design Review	3/JAN/00	
	Design Review Changes Included	5/JAN/00	
A	Initial Release	24/JAN/00	
B	Add switch to PB7/RST#	19/APR/00	
C	Modify IRQ# voltage select. Change input signal to VDD. Change RST# voltage. Added RFS_RESET	24/MAY/00	
D	Modify power circuitry - Vest on when board powered.	5/JUNE/00	
E	Change value of R23	26/JUNE/00	
F	Change wiring of J5 per customer request. J5 wiring now resembles J1.	17/JULY/00	

Last Update 17 July 00



**Software and Development Systems**  
6501 WILLIAM CANNON DRIVE WEST  
AUSTIN, TX 78735 USA

THIS DOCUMENT CONTAINS INFORMATION PROPRIETARY TO MOTOROLA AND SHALL NOT BE USED FOR ENGINEERING DESIGN, PROCUREMENT OR MANUFACTURE IN WHOLE OR IN PART WITHOUT CONSENT OF MOTOROLA.

DRAWN:	TESM Dev. / RRR	DATE:	19 Nov 99
CHECKED:	A. Okunami	DATE:	22-Jun-00
APPROVED:		DATE:	

Title:	IN CIRCUIT SIMULATOR - ICS08KX
Size:	B
Dwg. No.:	63BSE10080W
Sheet:	1 of 5

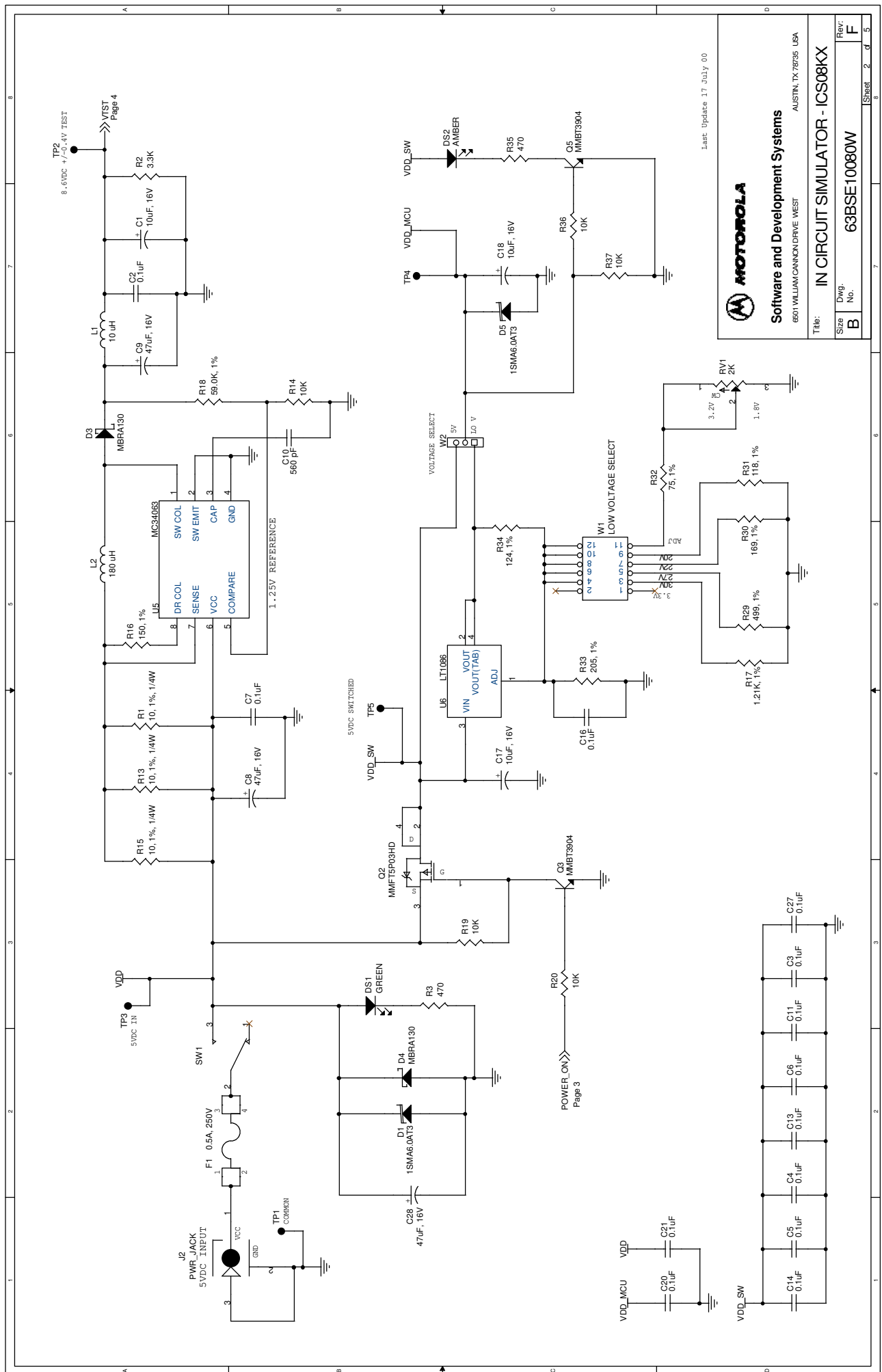

Last Update 17 July 00



Software and Development Systems  
6501 WILLIAM CANNON DRIVE WEST  
AUSTIN, TX 78735 USA

Title: IN CIRCUIT SIMULATOR - ICS08KX

Size	Dwg. No.	Rev.
B	63BSE10080W	F
	Sheet 2	of 5



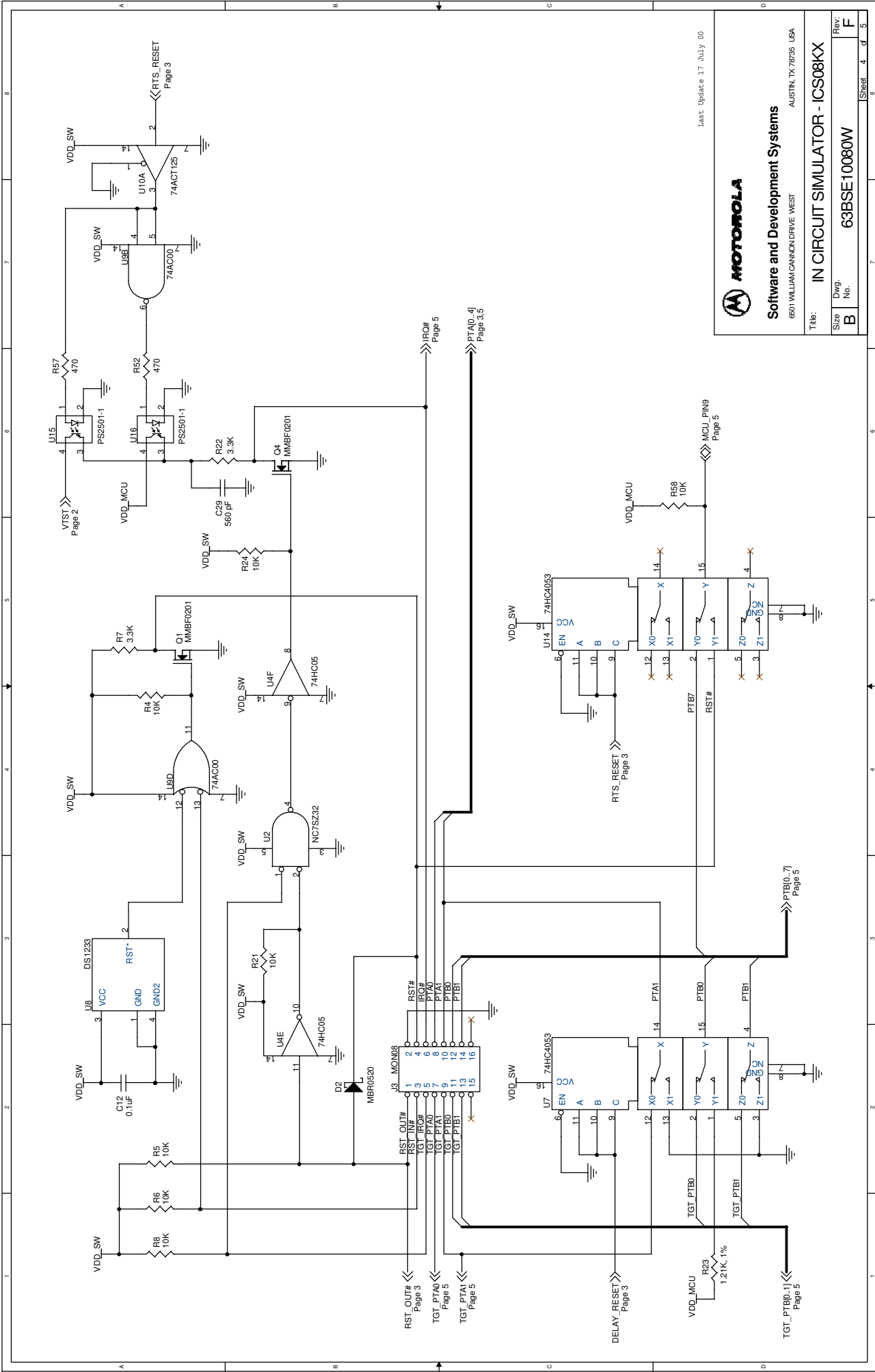

Last update 17 July 00



Software and Development Systems  
6501 WILLIAM CANNON DRIVE WEST  
AUSTIN, TX 78735 USA

Title: IN CIRCUIT SIMULATOR - ICS08KX

Size	B	Rev:	F
Dwg. No.	63BSE10080W	Sheet	4 of 5



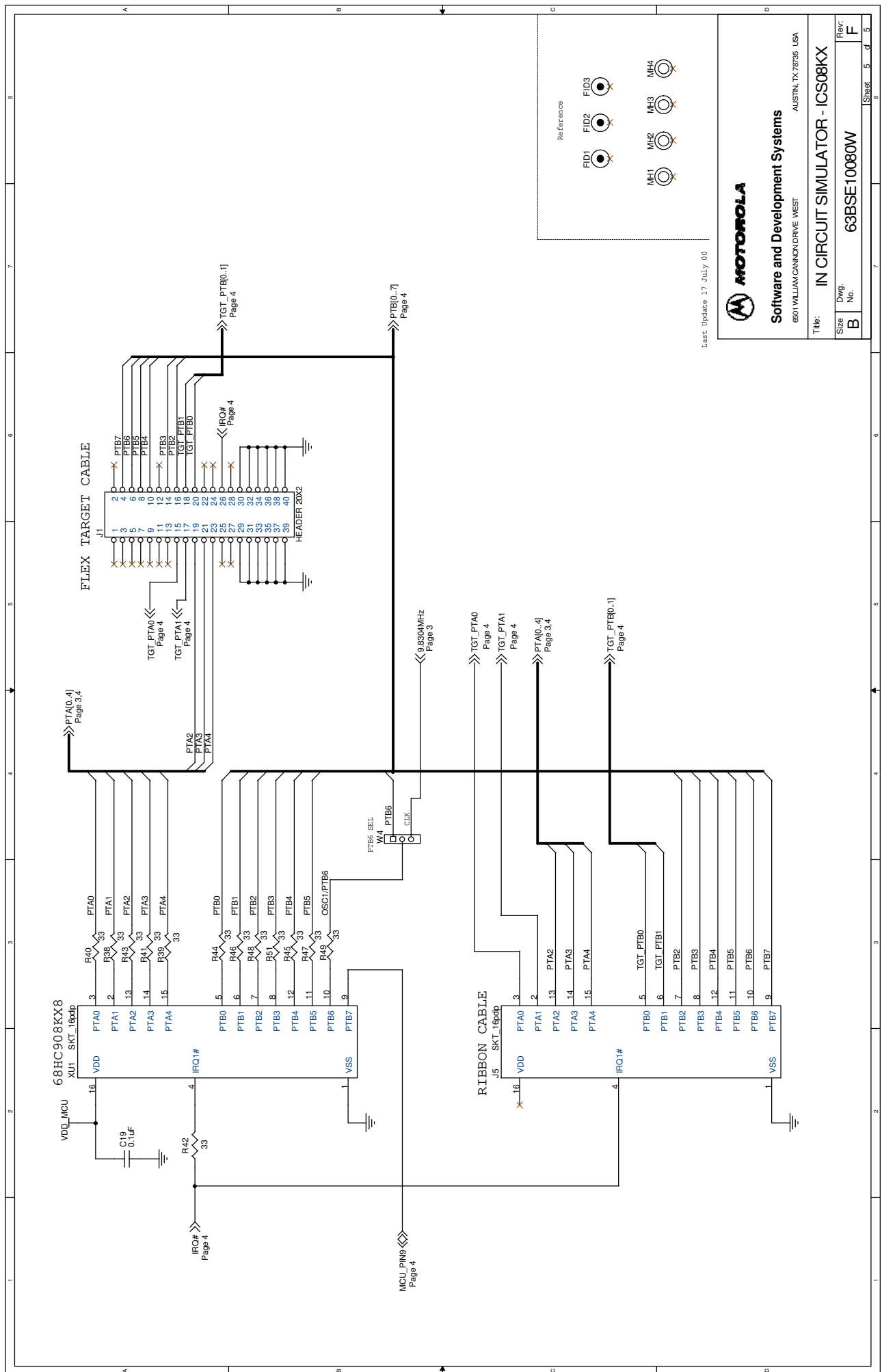

Last Update 17 July 00

**MOTOROLA**  
**Software and Development Systems**  
 6501 WILLIAM CANNON DRIVE WEST  
 AUSTIN, TX 78735 USA

Title: **IN CIRCUIT SIMULATOR - ICS08KX**

Size	Dwg. No.	Rev.
<b>B</b>	<b>63BSE10080W</b>	<b>F</b>
Sheet	5	5

## Section 4. Using the MON08 Interface

### 4.1 Introduction

The MON08 debugging interface may be used to debug and program a target system's MCU directly. The target system must be connected to the M68ICS08KX in-circuit simulator board's MON08 interface connector. This section explains how to connect to the MON08 interface on the target board.

### 4.2 Target System Header Placement and Layout

Two headers must be placed on the target board:

- P1 — 16-pin header such as Berg Electronics part number 67997-616
- P2 — 1-pin header such as Berg Electronics part number 68001-601

Table 4-1 shows the target-system interconnections for J3.

**Table 4-1. MON08 Target System Connector J3**

Pin No.	M68ICS08KX8 Label	Direction	Target System Connection
1	$\overline{\text{RST-OUT}}$	Out to target	Connect to logic that is to receive the $\overline{\text{RST}}$ signal.
2	GND	Ground	Connect to common ( $V_{SS}$ ).
3	$\overline{\text{RST-IN}}$	In from target	Connect to all logic that generates resets.
4	$\overline{\text{RST}}$	Bidirectional	Connect to MCU $\overline{\text{RST}}$ pin and P1 pin 1. No other target-system logic should be tied to this signal. It will swing from 0 to +5 Vdc.
5	$\overline{\text{TGT-IRQ}}$	In from target	Connect to logic that generates interrupts.
6	$\overline{\text{IRQ}}$	Out to target	Connect to MCU $\overline{\text{IRQ}}$ pin. No other target-system logic should be tied to this signal. It will swing from 0 to +8.6 Vdc.
7	TGT-PTA0	Bidirectional	Connect to user circuit that would normally be connected to PTA0 on the MCU. This circuit will not be connected to the MCU when the in-circuit simulator is being used.

**Table 4-1. MON08 Target System Connector J3 (Continued)**

Pin No.	M68ICS08KX8 Label	Direction	Target System Connection
8	PTA0	Bidirectional	Connect to MCU PTA0 pin. No other target-system logic should be tied to this signal. Host I/O present on this pin.
9	TGT-PTA1	Bidirectional	Connect to user circuit that normally would be connected to PTA1 on the MCU.
10	PTA1	Bidirectional	Connect to MCU PTA1 pin. No other target-system logic should be tied to this signal. Grounded during power-on reset and for 256 cycles after reset.
11	TGT-PTB0	Bidirectional	Connect to user circuit that normally would be connected to PTB0 on the MCU.
12	PTB0	Bidirectional	Connect to MCU PTB0 pin. No other target-system logic should be tied to this signal. Held at +5 Vdc during power-on reset.
13	TGT-PTB1	Bidirectional	Connect to user circuit that normally would be connected to PTB1 on the MCU.
14	PTB1	Bidirectional	Connect to MCU PTB1 pin. No other target-system logic should be tied to this signal. Grounded during power-on reset.
15	NC	NC	Not connected
16	NC	NC	Not connected

## 4.3 Connecting to the In-Circuit Simulator

Using the 16-pin cable provided with the KXICS kit, connect one end of the cable to the KXICS board at J3. Connect the other end to connector P1 on the target-system board. The pin-1 indicators on each cable end must correspond to the pin-1 indicators on the headers. P2 is not used when connecting to the KXICS board.

## Appendix A. S-Record Information

### A.1 Introduction

The Motorola S-record format was devised to encode programs or data files in a printable format for transport between computer platforms. The format also provides for editing of the S records and monitoring the cross-platform transfer process.

### A.2 S-Record Contents

Each S record is a character string composed of several fields which identify:

- Record type
- Record length
- Memory address
- Code/data
- Checksum

Each byte of binary data is encoded in the S record as a 2-character hexadecimal number:

- The first character represents the high-order four bits of the byte.
- The second character represents the low-order four bits of the byte.

The five fields that comprise an S record are shown in .

**Table A-1. S-Record Fields**

Type	Record Length	Address	Code/Data	Checksum
------	---------------	---------	-----------	----------

The S-record fields are described in .

**Table A-2. S-Record Field Contents**

Field	Printable Characters	Contents
Type	2	S-record type — S0, S1, etc.
Record Length	2	Character pair count in the record, excluding the type and record length.
Address	4, 6, or 8	2-, 3-, or 4-byte address at which the data field is to be loaded into memory.
Code/Data	0 – 2n	From 0 to n bytes of executable code, memory loadable data, or descriptive information. For compatibility with teletypewriter, some programs may limit the number of bytes to as few as 28 (56 printable characters in the S record).
Checksum	2	Least significant byte of the one's complement of the sum of the values represented by the pairs of characters making up the record length, address, and the code/data fields.

Each record may be terminated with a CR/LF/NULL. Additionally, an S record may have an initial field to accommodate other data such as line number generated by some time-sharing systems.

Accuracy of transmission is ensured by the record length (byte count) and checksum fields.

## A.3 S-Record Types

Eight types of S records have been defined to accommodate the several needs of the encoding, transport, and decoding functions. The various Motorola upload, download, and other record transport control programs, as well as cross assemblers, linkers, and other file-creating or debugging programs, utilize only those S records which serve the purpose of the program.

For specific information on which S records are supported by a particular program, consult the user manual for the program.

**NOTE:** *The ICS08RKZ supports only the S0, S1, and S9 record types. All data before the S1 record is ignored. Thereafter, all records must be S1 type until the S9 record, which terminates data transfer.*

An S-record format may contain the record types in .

**Table A-3. Record Types**

Record Type	Description
S0	Header record for each block of S records. The code/data field may contain any descriptive information identifying the following block of S records. The address field is normally 0s.
S1	Code/data record and the 2-byte address at which the code/data is to reside.
S2 – S8	Not applicable to ICS08RKZ
S9	Termination record for a block of S1 records. Address field may optionally contain the 2-byte address of the instruction to which control is to be passed. If not specified, the first interplant specification encountered in the input will be used. There is no code/data field.

Only one termination record is used for each block of S records. Normally, only one header record is used, although it is possible for multiple header records to occur.

## A.4 S Record Creation

S-record format programs may be produced by dump utilities, debuggers, cross assemblers, or cross linkers. Several programs are available for downloading a file in the S-record format from a host system to an 8- or 16-bit microprocessor-based system.

## A.5 S-Record Example

A typical S-record format, as printed or displayed, is shown in this example:

Example:

## S-Record Information

```
S00600004844521B
S1130000285F245F2212226A00042429008237C2A
S11300100002000800082529001853812341001813
S113002041E900084#42234300182342000824A952
S107003000144ED492
S9030000FC
```

In the example, the format consists of:

- An S0 header
- Four S1 code/data records
- An S9 termination record

### A.5.1 S0 Header Record

The S0 header record is described in .

**Table A-4. S0 Header Record**

Field	S-Record Entry	Description
Type	S0	S-record type S0, indicating a header record
Record Length	06	Hexadecimal 06 (decimal 6), indicating six character pairs (or ASCII bytes) follow
Address	00 00	4-character, 2-byte address field; zeroes
Code/Data	48 44 52	Descriptive information identified these S1 records: ASCII H D R — “HDR”
Checksum	1B	Checksum of S0 record

### A.5.2 First S1 Record

The first S1 record is described in .

**Table A-5. S1 Header Record**

Field	S-Record Entry			Description	
Type	S1			S-record type S1, indicating a code/data record to be loaded/verified at a 2-byte address	
Record Length	13			Hexadecimal 13 (decimal 19), indicating 19 character pairs, representing 19 bytes of binary data, follow	
Address	0000			4-character, 2-byte address field; hexadecimal address 0000 indicates location where the following data is to be loaded	
Code/Data	Opcode			Instruction	
	28	5F		BHCC	\$0161
	24	5F		BCC	\$0163
	22	12		BHI	\$0118
	22	6A		BHI	\$0172
	00	04	24	BRSET	0, \$04, \$012F
	29	00		BHCS	\$010D
	08	23	7C	BRSET	4, \$23, \$018C
Checksum	2A			Checksum of the first S1 record	

The 16 character pairs shown in the code/data field of are the ASCII bytes of the actual program.

The second and third S1 code/data records each also contain \$13 (19T) character pairs and are ended with checksum 13 and 52, respectively. The fourth S code/data record contains 07 character pairs and has a checksum of 92.

### A.5.3 S9 Termination Record

The S9 termination record is described in .

**Table A-6. S9 Header Record**

Field	S-Record Entry			Description	
Type	S9			S-record type S9, indicating a termination record	



**Table A-6. S9 Header Record**

Field	S-Record Entry	Description
Record Length	03	Hexadecimal 04, indicating three character pairs (three bytes) follow
Address	00 00	4-character, 2-byte address field; zeroes
Code/Data		There is no code/data in an S9 record.
Checksum	FC	Checksum of S9 record

## A.5.4 ASCII Characters

Each printable ASCII character in an S record is encoded in binary. gives an example of encoding for the S1 record. The binary data is transmitted during a download of an S record from a host system to a 9- or 16-bit microprocessor-based system. For example, the first S1 record in is sent as shown here.

TYPE		LENGTH		ADDRESS				CODE/DATA				...	CHECKSUM													
S	1	1	3	0	0	0	0	2	8	5	F	...	2	A												
5	3	3	1	3	1	3	3	3	0	3	0	3	0	3	2	3	8	3	5	4	6	...	3	2	4	1
0101	0011	0011	0001	0011	0001	0011	0011	0011	0000	0011	0000	0011	0000	0011	0010	0011	1000	0011	0101	0100	0110	...	0011	0010	0100	0001

## Appendix B. Quick Start Hardware Configuration Guide

### B.1 Introduction

This quick start guide explains the:

- Configuration of the M68ICS08KX in-circuit simulator (KXICS) board
- Installation of the hardware
- Connection of the board to a target system

There are four methods for configuring the KXICS: standalone, simulation, evaluation, and programming.

- Standalone — ICS08KXZ.exe is running on the host computer (the KXICS is not connected). Emulation of the MC68HC908KX8 MCU CPU, registers, and I/O ports is within the host computer environment.
- Simulation — Host computer is connected to the KXICS via the RS-232 cable, and the ICS08KXZ.exe is running on the host computer. This provides access to the MC68HC908KX8 MCU, internal registers, and I/O ports.
- Evaluation — Host computer is connected to the KXICS, and the KXICS is connected to the target system via the flex cable. This method provides limited real-time evaluation of the MCU and debugging user developed hardware and software.
- Programming — Host computer is connected to the KXICS, and the KXICS is connected to the target system via the MON08 cable. Use the PROG08SZ.exe to program the MCU FLASH module. In the programming mode there is limited evaluation.

**ESD CAUTION:** *Ordinary amounts of static electricity from clothing or the work environment can damage or degrade electronic devices and equipment. For example, the electronic components installed on the printed circuit board are extremely sensitive to electrostatic discharge (ESD). Wear a grounding wrist strap*

*whenever handling any printed circuit board. This strap provides a conductive path for safely discharging static electricity to ground.*

## B.1.1 KXICS Configurable Jumper Headers

Configure the seven jumper headers on the KXICS for your application according to the tables in this section.

**Table 4-2 KXICS Jumper Header Description**

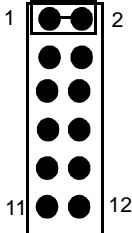
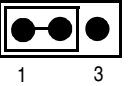
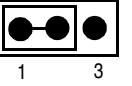
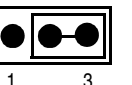
Jumper Header	Type (Factory Default Shown)	Description
W1 Low Voltage Select		<p>Used to set power for the MCU to match various target voltages. (No default)</p> <p>Jumper on position 1 &amp; 2: 3.3 V</p> <p>Jumper on position 3 &amp; 4: 3.0 V</p> <p>Jumper on position 5 &amp; 6: 2.7 V</p> <p>Jumper on position 7 &amp; 8: 2.2 V</p> <p>Jumper on position 9 &amp; 10: 2.0 V</p> <p>Jumper on position 11 &amp; 12: ADJ</p>
W2 MCU Voltage Select		<p>Selects voltage powering MCU and related circuitry.</p> <p>Jumper on position 1&amp;2: Regulator Lo V as set by W1, is supplied by MCU. Labeled LO V.</p> <p>Jumper on position 3&amp;2: Power supply, 5V Switched, is supplied by board to MCU. Labeled 5V.</p>
W3 Target Clock Enable		<p>Jumper on position 1&amp;2: supplies KXICS, 9.8304 MHz, clock, to MCU and target via W4.</p> <p>Jumper on position 3&amp;2: disables Xtal clock output, which will affect the power-up reset. Labeled 0.</p>
W4 PTB6 Select		<p>Jumper on position 1&amp;2: MCU's internal clock is supplied to target cable via PTB6.</p> <p>Jumper on position 3&amp;2: KXICS Xtal clock is supplied to MCU.</p>

## B.1.2 Target Interface Cable Connections

Below (Table 4-4) is a quick reference for defining the cable/connector setup to use with the MC68HC908KX8

Table 4-3 **Cable/Connector Options for MCUs**

MCU	Flex Cable	Ribbon Cable	MON08 Cable
MC68HC908KX8	J1	J5	J3

## B.1.3 Host Computer — KXICS Interconnection (J6)

Connect the DE9 serial cable. Connect one end of this cable to your host PC and the other end to connector J6 on the KXICS board.

## B.2 Installing the Hardware

For installing Motorola development tools, the following steps provide installation instructions for the KXICS hardware.

To prepare the KXICS (Figure 2-1) for use with a host PC:

1. Install an MCU (DIP or SOIC) into the KXICS board.

DIP-type MCU:

- a. Place the pin tension arm of the KXICS DIP socket XU1 in the up position.
- b. Install the DIP type MCU into the DIP socket XU1. Be sure that the pin 1 orientation of the silkscreened dot on the MCU aligns with the pin 1 location on the DIP socket (upper left pin of the socket) .
- c. Place the pin tension arm of the KXICS DIP socket XU1 in the down position to secure the pins of the MCU to the socket.

**NOTE:** *The top (label side) of the MCU package must be visible when looking at the component side of the board.*

SOIC-type MCU:

**NOTE:** *Installation of a SOIC type MCU requires the use of the SOIC-to-DIP adapter identified in Table 1-1 of this manual.*

- a. Place the pin tension arm of the KXICS DIP socket XU1 in the up position.
- b. Install the SOIC-to-DIP adapter into the DIP socket XU1. Be sure that the pin 1 orientation of the adapter aligns with the pin 1 location on the DIP socket (upper left pin of the DIP socket).

**CAUTION:** *The SOIC-to-DIP adapter may be confusing to install. It must be placed into the DIP socket, XU1, with the hinged side of the SOIC shell aligned at the bottom of the KXICS board. This positioning will place the SOIC-type MCU socket pin 1 in the upper left corner of the SOIC socket.*

- c. Place the pin tension arm of the KXICS DIP socket XU1 in the down position to secure the pins of the adapter to the socket.
  - d. Open the hinged access door on the SOIC shell.
  - e. Install the SOIC-type MCU into the SOIC socket of the adapter. Be sure that the pin 1 orientation of the silkscreened dot on the MCU aligns with the pin 1 location on the SOIC socket (upper left pin of the socket).
  - f. Close and secure the hinged access door on the SOIC shell.
2. Connect the board to the host PC.

Locate the 9-pin connector labeled J6 on the board. Using the cable provided, connect it to a serial COM port on the host PC.

3. Apply power to the board.

Connect the 5-volt power supply to the round connector on the board, J2. Plug the power supply into an ac power outlet, using one of the country-specific adapters provided. (The KXICS green power LED on the board should light when switch SW1 is in the ON position.)

### B.3 Installing the Software

For instructions for installing the ICS08 software, refer to P&E Microcomputer Systems, Inc., *M68ICS08KX In-Circuit Simulator Operator's Manual*.

## B.4 Connecting to a Target System

The three ways to connect the M68ICS08KX simulator board to a target system are via:

- The flex cable
- The ribbon cable
- The MON08 cable

Connect the simulator board to the target system using one of these methods:

- Using a flex cable

When emulating an MC68HC908KX MCU, connect the 16-pin M68CLB05A flex cable (may be ordered) to the connectors labeled J1. Attach the other end of the cable to the appropriate connector on the target system. Target head adapters are available for the 16-pin SDIP, 16-pin DIP, and 16-pin SOIC versions of the MCU.

- Using a ribbon cable

When emulating an MC68HC908KX MCU connect a 16-pin flat ribbon cable to connector J5 on the simulator board. Attach the other end of the cable to the appropriate connector on the target system.

- Using a MON08 cable

Connect the MON08 debug interface cable to the MON08 debug interface connector J3 for communication with the target system's MCU. The MON08 cable lets you program and debug the target system's MCU FLASH. An MCU must be installed in the target system, and there should be no MCU installed in the KXICS.



# Glossary

**8-bit MCU** — A microcontroller whose data is communicated over a data bus made up of eight separate data conductors. Members of the MC68HC908 Family of microcontrollers are 8-bit MCUs.

**A** — An abbreviation for the accumulator of the MC68HC908KX8 MCU.

**accumulator** — An 8-bit register of the MC68HC908KX8 CPU. The contents of this register may be used as an operand of an arithmetic or logical instruction.

**assembler** — A software program that translates source code mnemonics into opcodes that can then be loaded into the memory of a microcontroller.

**assembly language** — Instruction mnemonics and assembler directives that are meaningful to programmers and can be translated into an object code program that a microcontroller understands. The CPU uses opcodes and binary numbers to specify the operations that make up a computer program. Humans use assembly language mnemonics to represent instructions. Assembler directives provide additional information such as the starting memory location for a program. Labels are used to indicate an address or binary value.

**ASCII** — American Standard Code for Information Interchange. A widely accepted correlation between alphabetic and numeric characters and specific 7-bit binary numbers.

**breakpoint** — During debugging of a program, it is useful to run instructions until the CPU gets to a specific place in the program, and then enter a debugger program. A breakpoint is established at the desired address by temporarily substituting a software interrupt (SWI) instruction for the instruction at that address. In response to the SWI, control is passed to a debugging program.

**byte** — A set of exactly eight binary bits.



- C** — An abbreviation for carry/borrow in the condition codes register of the MC68HC908KX8. When adding two unsigned 8-bit numbers, the C bit is set if the result is greater than 255 (\$FF).
- CCR** — An abbreviation for condition code register in the MC68HC908KX8. The CCR has five bits (H, I, N, Z, and C) that can be used to control conditional branch instructions. The values of the bits in the CCR are determined by the results of previous operations. For example, after a load accumulator (LDA) instruction, Z will be set if the loaded value was \$00.
- clock** — A square wave signal that is used to sequence events in a computer.
- command set** — The command set of a CPU is the set of all operations that the CPU knows how to perform. One way to represent an instruction set is with a set of shorthand mnemonics such as LDA meaning load A. Another representation of an instruction set is the opcodes that are recognized by the CPU.
- condition codes register** — The CCR has five bits (H, I, N, Z, and C) that can be used to control conditional branch commands. The values of the bits in the CCR are determined by the results of previous operations. For example, after a load accumulator (LDA) instruction, Z will be set if the loaded value was \$00.
- CPU** — Central processor unit. The part of a computer that controls execution of instructions.
- CPU cycles** — A CPU clock cycle is one period of the internal bus-rate clock. Normally, this clock is derived by dividing a crystal oscillator source by two or more so the high and low times will be equal. The length of time required to execute an instruction is measured in CPU clock cycles.
- CPU registers** — Memory locations that are wired directly into the CPU logic instead of being part of the addressable memory map. The CPU always has direct access to the information in these registers. The CPU registers in an MC68HC908 are A (8-bit accumulator), X (8-bit index register), CCR (condition code register containing the H, I, N, Z, and C bits), SP (stack pointer), and PC (program counter).

**cycles** — See CPU cycles.

**data bus** — A set of conductors that are used to convey binary information from a CPU to a memory location or from a memory location to a CPU; in the MC68HC908KX8, the data bus is 8-bits.

**development tools** — Software or hardware devices used to develop computer programs and application hardware. Examples of software development tools include text editors, assemblers, debug monitors, and simulators. Examples of hardware development tools include simulators, logic analyzers, and PROM programmers. An in-circuit simulator combines a software simulator with various hardware interfaces.

**EPROM** — Erasable, programmable read-only memory. A non-volatile type of memory that can be erased by exposure to an ultra-violet light source. MCUs that have EPROM are easily recognized by their packaging: a quartz window allows exposure to UV light. If an EPROM MCU is packaged in an opaque plastic package, it is termed a one-time-programmable OTP MCU, since there is no way to erase and rewrite the EPROM.

**EEPROM** — Electrically erasable, programmable read-only memory.

**H** — Abbreviation for half-carry in the condition code register of the MC68HC908KX8. This bit indicates a carry from the low-order four bits of an 8-bit value to the high-order four bits. This status indicator is used during BCD calculations.

**I** — Abbreviation for interrupt mask bit in the condition code register of the MC68HC908KX8.

**index register** — An 8-bit CPU register in the MC68HC908KX8 that is used in indexed addressing mode. The index register (X) also can be used as a general-purpose 8-bit register in addition to the 8-bit accumulator.

**input-output (I/O)** — Interfaces between a computer system and the external world. For example, a CPU reads an input to sense the level of an external signal and writes to an output to change the level on an external signal.

- instructions** — Instructions are operations that a CPU can perform. Instructions are expressed by programmers as assembly language mnemonics. A CPU interprets an opcode and its associated operand(s) as an instruction.
- listing** — A program listing shows the binary numbers that the CPU needs alongside the assembly language statements that the programmer wrote. The listing is generated by an assembler in the process of translating assembly language source statements into the binary information that the CPU needs.
- LSB** — Least significant bit.
- MCU – Microcontroller unit** — Microcontroller. A complete computer system including CPU, memory, clock oscillator, and I/O on a single integrated circuit.
- MSB** — Most significant bit.
- N** — Abbreviation for negative, a bit in the condition code register of the MC68HC908KX8. In two's-complement computer notation, positive signed numbers have a 0 in their MSB (most significant bit) and negative numbers have a 1 in their MSB. The N condition code bit reflects the sign of the result of an operation. After a load accumulator instruction, the N bit will be set if the MSB of the loaded value was a 1.
- object code file** — A text file containing numbers that represent the binary opcodes and data of a computer program. An object code file can be used to load binary information into a computer system. Motorola uses the S-record file format for object code files.
- operand** — An input value to a logical or mathematical operation.
- opcode** — A binary code that instructs the CPU to do a specific operation in a specific way. The MC68HC908KX8 CPU recognizes 210 unique 8-bit opcodes that represent addressing mode variations of 62 basic instructions.
- OTPROM** — A non-volatile type of memory that can be programmed but cannot be erased. An OTPROM is an EPROM MCU that is packaged in an opaque plastic package. It is called a one-time-programmable

MCU because there is no way to expose the EPROM to a UV light.

**PC** — Abbreviation for program counter CPU register of the MC68HC908KX8.

**program counter** — The CPU register that holds the address of the next instruction or operand that the CPU will use.

**RAM** — Random access memory. Any RAM location can be read or written by the CPU. The contents of a RAM memory location remain valid until the CPU writes a different value or until power is turned off.

**registers** — Memory locations that are wired directly into the CPU logic instead of being part of the addressable memory map. The CPU always has direct access to the information in these registers. The CPU registers in the MC68HC908KX8 are A (8-bit accumulator), X (8-bit index register), CCR (condition code register containing the H, I, N, Z, and C bits), SP (stack pointer), and PC (program counter). Memory locations that hold status and control information for on-chip peripherals are called I/O and control registers.

**reset** — Reset is used to force a computer system to a known starting point and to force on-chip peripherals to known starting conditions.

**S record** — A Motorola standard format used for object code files.

**simulator** — A computer program that copies the behavior of a real MCU.

**source code** — See source program.

**SP** — Abbreviation for stack pointer CPU register in the MC68HC908KX8 MCU.

**source program** — A text file containing instruction mnemonics, labels, comments, and assembler directives. The source file is processed by an assembler to produce a composite listing and an object file representation of the program.

**stack pointer** — A CPU register that holds the address of the next available storage location on the stack.

**TTL** — Transistor-to-transistor logic.

**V<sub>DD</sub>** — The positive power supply to a microcontroller (typically 5 volts dc).

**V<sub>SS</sub>** — The 0-volt dc power supply return for a microcontroller.

**Word** — A group of binary bits. Some larger computers consider a set of 16 bits to be a word but this is not a universal standard.

**X** — Abbreviation for index register, a CPU register in the MC68HC908KX8.

**Z** — Abbreviation for zero, a bit in the condition code register of the MC68HC908KX8. A compare instruction subtracts the contents of the tested value from a register. If the values were equal, the result of this subtraction would be 0 so the Z bit would be set; after a load accumulator instruction, the Z bit will be set if the loaded value was \$00.

## User's Manual — M68ICS08KX In-Circuit Simulator

---

### Index

#### A

ASCII	
characters .....	44

#### B

Bill of Materials .....	33
Board layout .....	36

#### C

Cables	
Flex .....	7
Serial .....	7
checksum .....	39
Clock frequency .....	26
Clock selection .....	26
Configuration	
Standalone .....	45
Configuration options	
Evaluation .....	12, 45
Jumper Table .....	13, 46
Programming .....	12, 45
Simulation .....	12, 45
Standalone options .....	12
Connectors	
J1 .....	16, 28
J2 .....	19, 31
J3 .....	18, 30, 37
J4 .....	27
J5 .....	17, 29
J6 .....	19, 32
MON08 .....	37

**D**

Debugging interface .....	37
Delay Reset .....	26
DIP .....	23

**E**

examples	
S records .....	41

**H**

Half-duplex mode .....	26
hardware	
installation .....	45
Headers	
P1 .....	37
P2 .....	37
High voltage transients .....	24
Host	
interface .....	24
Host computer requirements .....	9

**I**

ICS PWR LED .....	15
Interface Connection Options .....	15
Flex cable .....	15
MON08 cable .....	15
Ribbon cable .....	15

**J**

J4 .....	27
----------	----

**K**

KXICS	
connections .....	3
description .....	3
features .....	3, 5

Hardware components .....	8
Hardware operator's manual.....	7
operation voltage range.....	24
product components .....	7
PWR LED.....	49
SOIC-to-DIP Socket Adapter .....	7
<b>KXICS Software</b>	
components.....	8
debugger/emulator .....	7
development package .....	7
operator's manual .....	7
simulator .....	7

## L

<b>LED</b>	
amber .....	25
ICS power.....	15, 49
<b>Limitations</b>	
Bus Frequency .....	11
Internal Clock Generator .....	12
Low Voltage Interrupt .....	12
Port A0 .....	11

## M

<b>MCU</b>	
internal clock.....	27
operating modes .....	24
packages .....	23
subsystem .....	23
timing source.....	26
<b>memory</b>	
address .....	39
<b>Microcontroller</b>	
DIP .....	7
SOIC .....	7
<b>Modes of operation.....</b>	5
<b>MON08.....</b>	37
<b>MON08 connection.....</b>	38
<b>Monitor Mode.....</b>	27



## P

Parts list . . . . .	33
Power . . . . .	24
DTR . . . . .	25
on/off. . . . .	25

## R

record length . . . . .	39
record type . . . . .	39
Reset . . . . .	26
RTS signal. . . . .	26

## S

S records . . . . .	39–44
Schematics . . . . .	36
Serial communications . . . . .	26
serial port	
connector. . . . .	14
Silk screen. . . . .	36
Software support programs	
assembling . . . . .	5
debugging . . . . .	5
editing . . . . .	5
emulating . . . . .	5
programming. . . . .	5
simulating . . . . .	5
SOIC . . . . .	23
SOIC-to-DIP Socket Adapter . . . . .	7
S-record	
content. . . . .	39
creating . . . . .	41
field contents. . . . .	39
fields . . . . .	39
overview . . . . .	39
S0 record. . . . .	42
S1 record. . . . .	42
S9 record. . . . .	43
termination record. . . . .	43
types . . . . .	40
Start-Up. . . . .	27

**T**

Target system  
    connecting to..... 49  
Test points..... 25

**V**

VTST ..... 26

**Y**

Y1 ..... 26, 27





Motorola reserves the right to make changes without further notice to any products herein. Motorola makes no warranty, representation or guarantee regarding the suitability of its products for any particular purpose, nor does Motorola assume any liability arising out of the application or use of any product or circuit, and specifically disclaims any and all liability, including without limitation consequential or incidental damages. "Typical" parameters which may be provided in Motorola data sheets and/or specifications can and do vary in different applications and actual performance may vary over time. All operating parameters, including "Typicals" must be validated for each customer application by customer's technical experts. Motorola does not convey any license under its patent rights nor the rights of others. Motorola products are not designed, intended, or authorized for use as components in systems intended for surgical implant into the body, or other applications intended to support or sustain life, or for any other application in which the failure of the Motorola product could create a situation where personal injury or death may occur. Should Buyer purchase or use Motorola products for any such unintended or unauthorized application, Buyer shall indemnify and hold Motorola and its officers, employees, subsidiaries, affiliates, and distributors harmless against all claims, costs, damages, and expenses, and reasonable attorney fees arising out of, directly or indirectly, any claim of personal injury or death associated with such unintended or unauthorized use, even if such claim alleges that Motorola was negligent regarding the design or manufacture of the part. Motorola and  are registered trademarks of Motorola, Inc. Motorola, Inc. is an Equal Opportunity/Affirmative Action Employer.

**How to reach us:**

**USA/EUROPE/Locations Not Listed:** Motorola Literature Distribution, P.O. Box 5405, Denver, Colorado 80217. 1-303-675-2140 or 1-800-441-2447. Customer Focus Center, 1-800-521-6274

**JAPAN:** Motorola Japan Ltd.; SPS, Technical Information Center, 3-20-1, Minami-Azabu, Minato-ku, Tokyo 106-8573 Japan. 81-3-3440-8573

**ASIA/PACIFIC:** Motorola Semiconductors H.K. Ltd.; Silicon Harbour Centre, 2 Dai King Street, Tai Po Industrial Estate, Tai Po, N.T., Hong Kong. 852-26668334

**Mfax™, Motorola Fax Back System:** RMFAX0@email.sps.mot.com; <http://sps.motorola.com/mfax/>;  
TOUCHTONE, 1-602-244-6609; US and Canada ONLY, 1-800-774-1848

**HOME PAGE:** <http://motorola.com/sps/>

Mfax is a trademark of Motorola, Inc.



**MOTOROLA**

© Motorola, Inc., 2000

**M68ICS08KXUM/D**