

REVISIONS					
P	LTR	DESCRIPTION	DATE	DWN	APVD
	A1	REVISED	08SEP2020	J.J	W.H

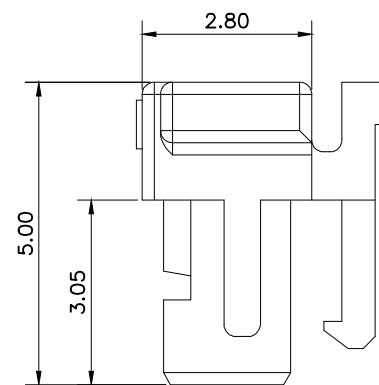
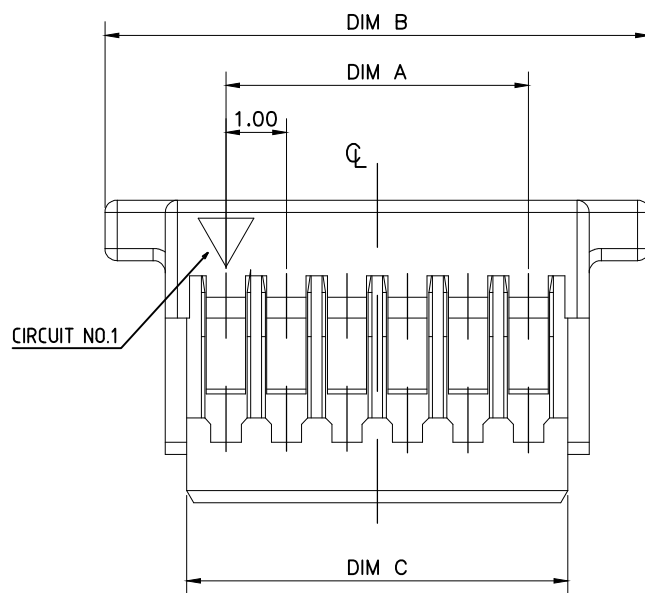
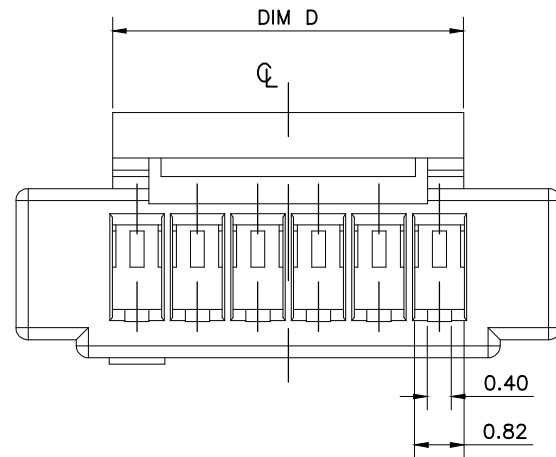

NOTES:
 1. MATERIAL: HALOGEN FREE PLASTIC, UL94V-0.
 2. CABLE CONTACT: 2367199-1

5.8	15.4	18.0	14.0	15	3-2367198-5	1-2367198-5
	14.4	17.0	13.0	14	3-2367198-4	1-2367198-4
	13.4	16.0	12.0	13	3-2367198-3	1-2367198-3
	12.4	15.0	11.0	12	3-2367198-2	1-2367198-2
	11.4	14.0	10.0	11	3-2367198-1	1-2367198-1
	10.4	13.0	9.0	10	3-2367198-0	1-2367198-0
	9.4	12.0	8.0	9	2-2367198-9	2367198-9
	8.4	11.0	7.0	8	2-2367198-8	2367198-8
	7.4	10.0	6.0	7	2-2367198-7	2367198-7
6.4	9.0	5.0	6	2-2367198-6	2367198-6	
4.8	5.4	8.0	4.0	5	2-2367198-5	2367198-5
3.0	4.4	7.0	3.0	4	2-2367198-4	2367198-4
3.0	3.4	6.0	2.0	3	2-2367198-3	2367198-3
DIM.D	DIM.C	DIM,B	DIM.A	POS.NO	NATURAL	BLACK
						COLOR
						P/N

THIS DRAWING IS A CONTROLLED DOCUMENT.		DWN Tommy Qian 18DEC2019	TE Connectivity			
DIMENSIONS: mm		CHK Wenke He				
TOLERANCES UNLESS OTHERWISE SPECIFIED:		APVD Wenke He	1.0P WT B CABLE HOUSING WITH LATCH			
0 PLC ± 0.5 1 PLC ± 0.35 2 PLC ± 0.25 3 PLC ± 0.15 4 PLC ± - ANGLES ± 2°		PRODUCT SPEC 108-115169	RESTRICTED TO			
MATERIAL SEE NOTE		FINISH -	APPLICATION SPEC 114-115031	SIZE A3	CAGE CODE 00779	DRAWING NO C-2367198
CUSTOMER DRAWING			WEIGHT	SCALE N/A	SHEET 1 OF 2	REV A1

© - TE Connectivity. All Rights Reserved.

REVISIONS					
P	LTR	DESCRIPTION	DATE	DWN	APVD
-	-	SEE SHEET 1	-	-	-

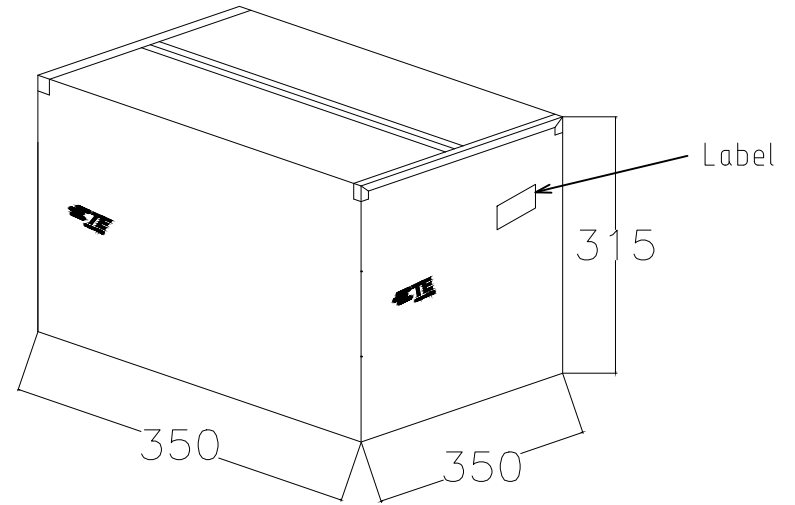
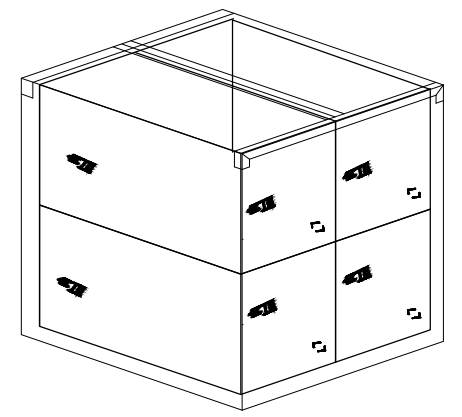
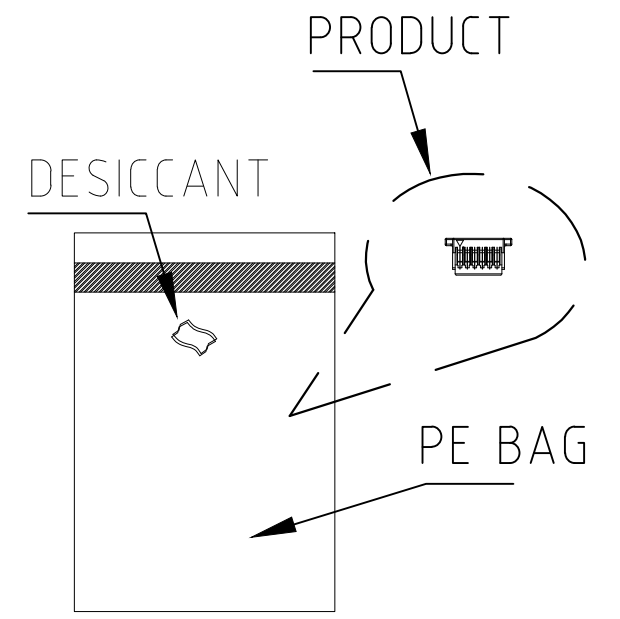
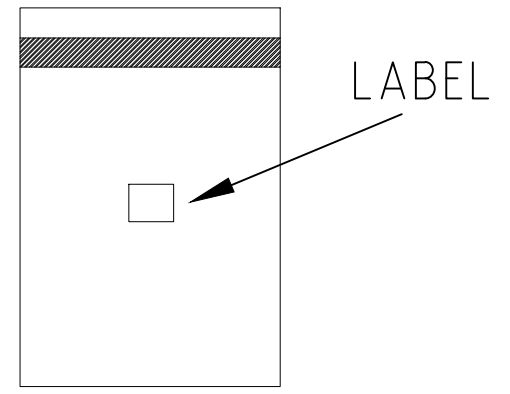
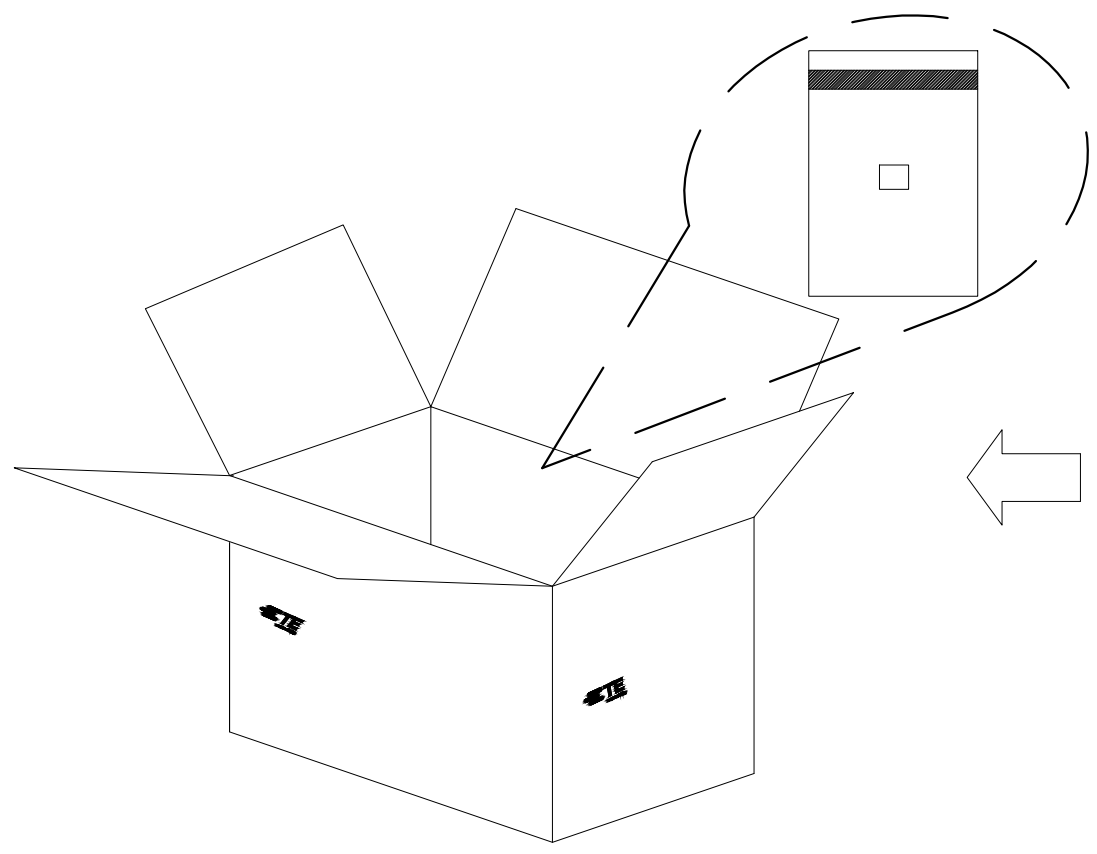

PART NUMBER	PCS/PEG	PCS/CARTON
2-2367198-3	2367198-3	1600
2-2367198-4	2367198-4	1600
2-2367198-5	2367198-5	1600
2-2367198-6	2367198-6	1600
2-2367198-7	2367198-7	1600
2-2367198-8	2367198-8	1600
2-2367198-9	2367198-9	1600
3-2367198-0	1-2367198-0	1600
3-2367198-1	1-2367198-1	1600
3-2367198-2	1-2367198-2	1600
3-2367198-3	1-2367198-3	1600
3-2367198-4	1-2367198-4	1600
3-2367198-5	1-2367198-5	1600

Put 4 small carton into out carton

NOTES:
PACKAGE FOR *-2367198-*

THIS DRAWING IS A CONTROLLED DOCUMENT.		DWN Tommy Qian 18DEC2019	 TE Connectivity				
DIMENSIONS: mm		CHK Wenke He				NAME 1.0P WT B CABLE HOUSING WITH LATCH	
TOLERANCES UNLESS OTHERWISE SPECIFIED:		APVD Wenke He	PRODUCT SPEC 108-115169				
0 PLC ± 0.5 1 PLC ± 0.35 2 PLC ± 0.25 3 PLC ± 0.15 4 PLC ± - ANGLES ± *		PRODUCT SPEC 108-115169				APPLICATION SPEC 114-115031	
MATERIAL SEE NOTE		FINISH -	WEIGHT	SIZE A3	CAGE CODE 00779		
CUSTOMER DRAWING			SCALE N/A	SHEET 2 OF 2	REV A1		