

### DESCRIPTION

The EV3418-J-00A Evaluation Board is designed to demonstrate the capabilities of MPS' MP3418. With an input from 1.2V through 4V it can accommodate typical 0.1A continuous current to load.

The MP3418 is a high-efficiency, synchronous, current-mode, step-up converter with output disconnect. MP3418 can start up from an input voltage as low as 0.8V to provide a output voltage from 1.8V through 4V. It also integrates inrush current limiting, output short-circuit protection, DOWN mode operation, OTP and other necessary functions for excellent performances. The 1.2MHz switching frequency allows for smaller external components to achieve low cost.

MP3418 can be available in SOT23-8 package.

### ELECTRICAL SPECIFICATION

Parameter	Symbol	Value	Units
Supply Voltage	$V_{IN}$	0.8 – 4	V
Output Voltage	$V_{OUT}$	3.3	V

### FEATURES

- Up to 96% Efficiency
- 0.8V Low Voltage Start-Up, 0.6V-to-4V Input Range
- 1.8V-to-4V Output Range
- Internal Synchronous Rectifier
- Typical 38 $\mu$ A Quiescent Current
- Typical 0.1 $\mu$ A Shutdown Current
- True Output Disconnect from Input
- $V_{IN} > V_{OUT}$  Down Mode Operation
- High Efficiency under Light-Load Conditions
- Very Small External Components
- Inrush Current Limiting and Internal Soft-Start
- OVP, SCP, OTP
- TSOT23-8 Package

### APPLICATIONS

- Battery powered products
- Personal Medical devices
- Portable Media Players
- Wireless Peripherals
- Handheld Computers and Smartphones

All MPS parts are lead-free and adhere to the RoHS directive. For MPS green status, please visit MPS website under Products, Quality Assurance page.

"MPS" and "The Future of Analog IC Technology", are Registered Trademarks of Monolithic Power Systems, Inc.

## EV3418-J-00A EVALUATION BOARD



(L x W x H) 6.35cm x 6.35cm x 1.0cm

Board Number	MPS IC Number
EV3418-J-00A	MP3418GJ

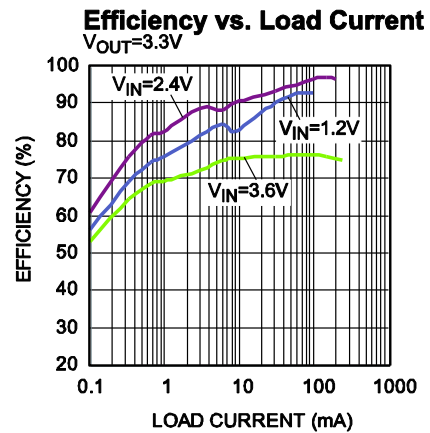

## EVALUATION BOARD SCHEMATIC

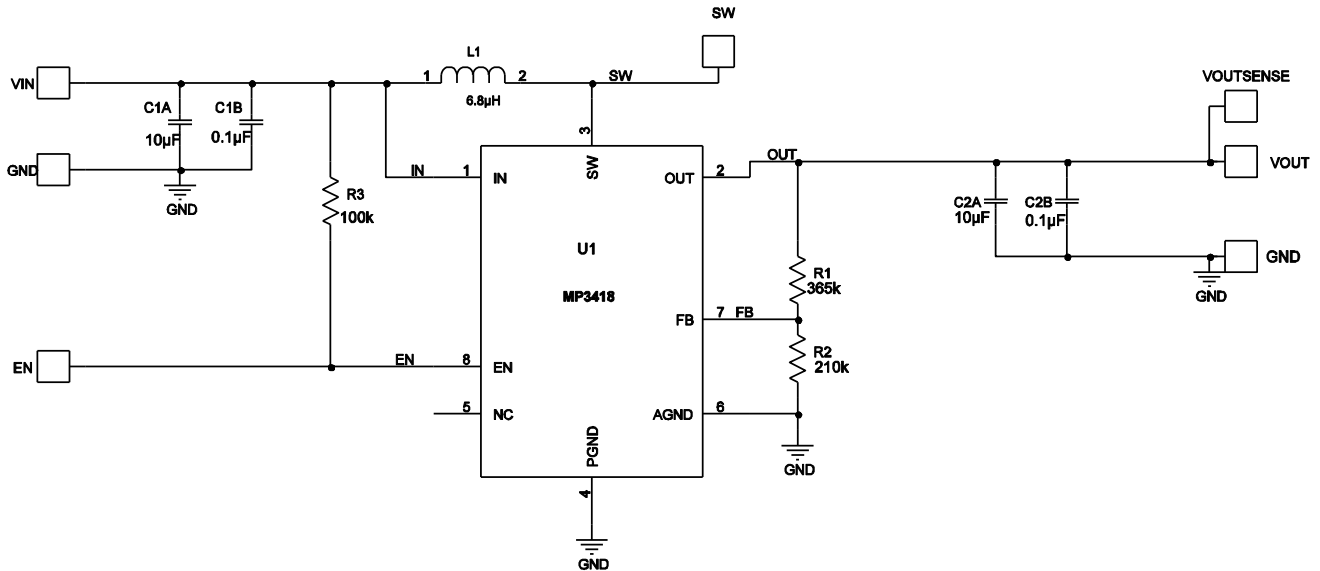

## EV3418-J-00A BILL OF MATERIALS

Qty	RefDes	Value	Description	Package	Manufacturer	Manufacturer_P/N
1	C1A, C2A	10µF	Ceramic Cap., 16V, X7R	1210	muRata	GRM32DR71C106KA01L
2	C1B,C2B	0.1µF	Ceramic Cap., 16V, X7R	0603	muRata	GRM188R71C104KA01D
1	R1	365k	Film Res., 1%	0603	Yageo	RC0603FR-07365KL
1	R2	210k	Film Res., 1%	0603	Yageo	RC0603FR-07210KL
1	R3	100k	Film Res., 1%	0603	Yageo	RC0603FR-07100KL
1	L1	6.8µH	80mOhm DCR, 1.25A Isat	SMD	Wurth	744043006
1	U1		Step-Up Converter	SOT23-8	MPS	MP3418GJ

## EVB TEST RESULTS

Performance waveforms are tested on the evaluation board.

$V_{IN} = 2.4V$ ,  $V_{OUT} = 3.3V$ ,  $L = 6.8\mu H$ ,  $C_{OUT} = 10\mu F$ ,  $T_A = 25^\circ C$ , unless otherwise noted.

**Output Voltage Ripple**

$I_{OUT} = 0mA$

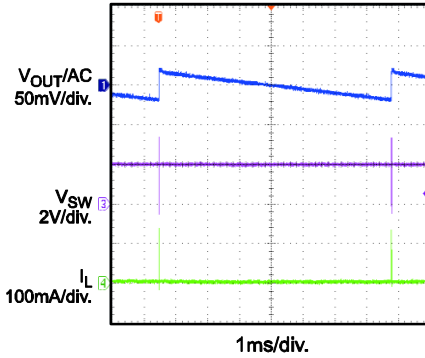

**Output Voltage Ripple**

$I_{OUT} = 20mA$

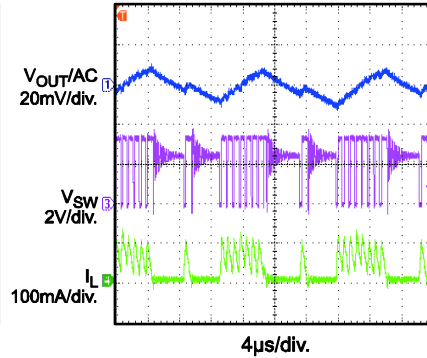

**Output Voltage Ripple**

$I_{OUT} = 100mA$

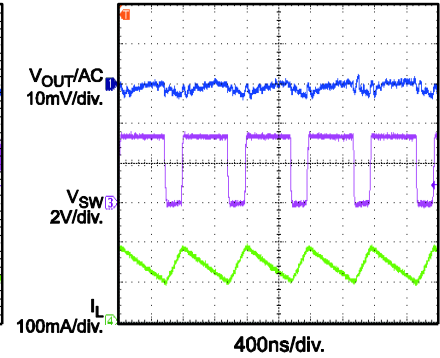

**V<sub>IN</sub> Startup**

$I_{OUT} = 0mA$

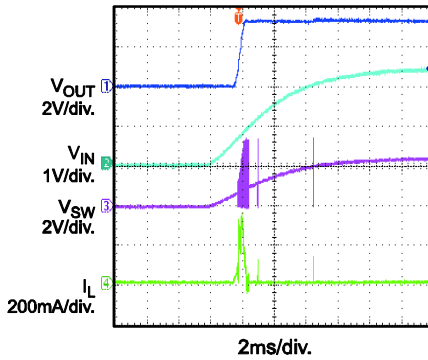

**V<sub>IN</sub> Startup**

$I_{OUT} = 100mA$

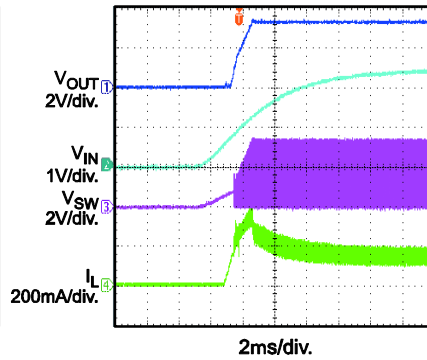

**V<sub>IN</sub> Shutdown**

$V_{IN} = 3.6V$ ,  $I_{OUT} = 20mA$

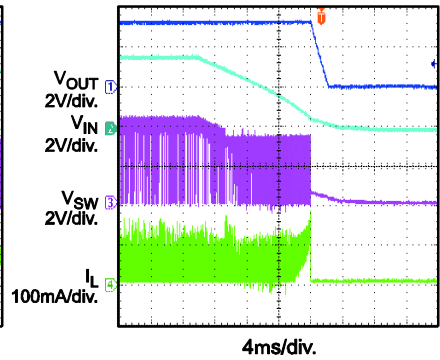

**V<sub>IN</sub> Shutdown**

$V_{IN} = 3.6V$ ,  $I_{OUT} = 100mA$

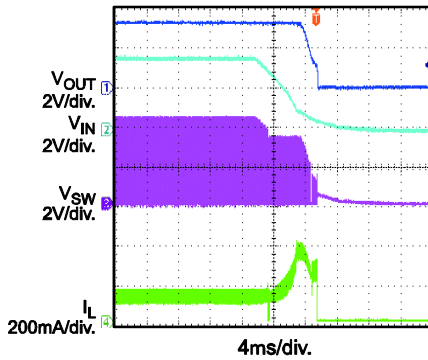

**EN Startup**

$I_{OUT} = 0mA$

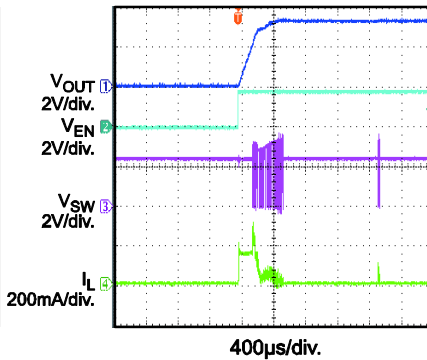

**EN Startup**

$I_{OUT} = 100mA$

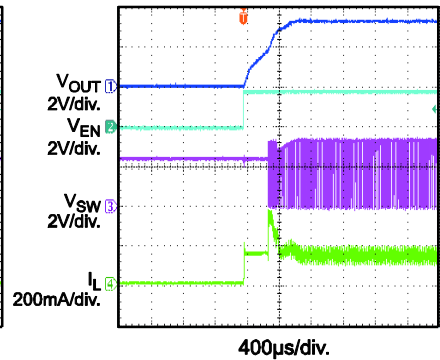

## EVB TEST RESULTS (continued)

Performance waveforms are tested on the evaluation board.

$V_{IN} = 2.4V$ ,  $V_{OUT} = 3.3V$ ,  $L = 6.8\mu H$ ,  $C_{OUT} = 10\mu F$ ,  $T_A = 25^\circ C$ , unless otherwise noted.

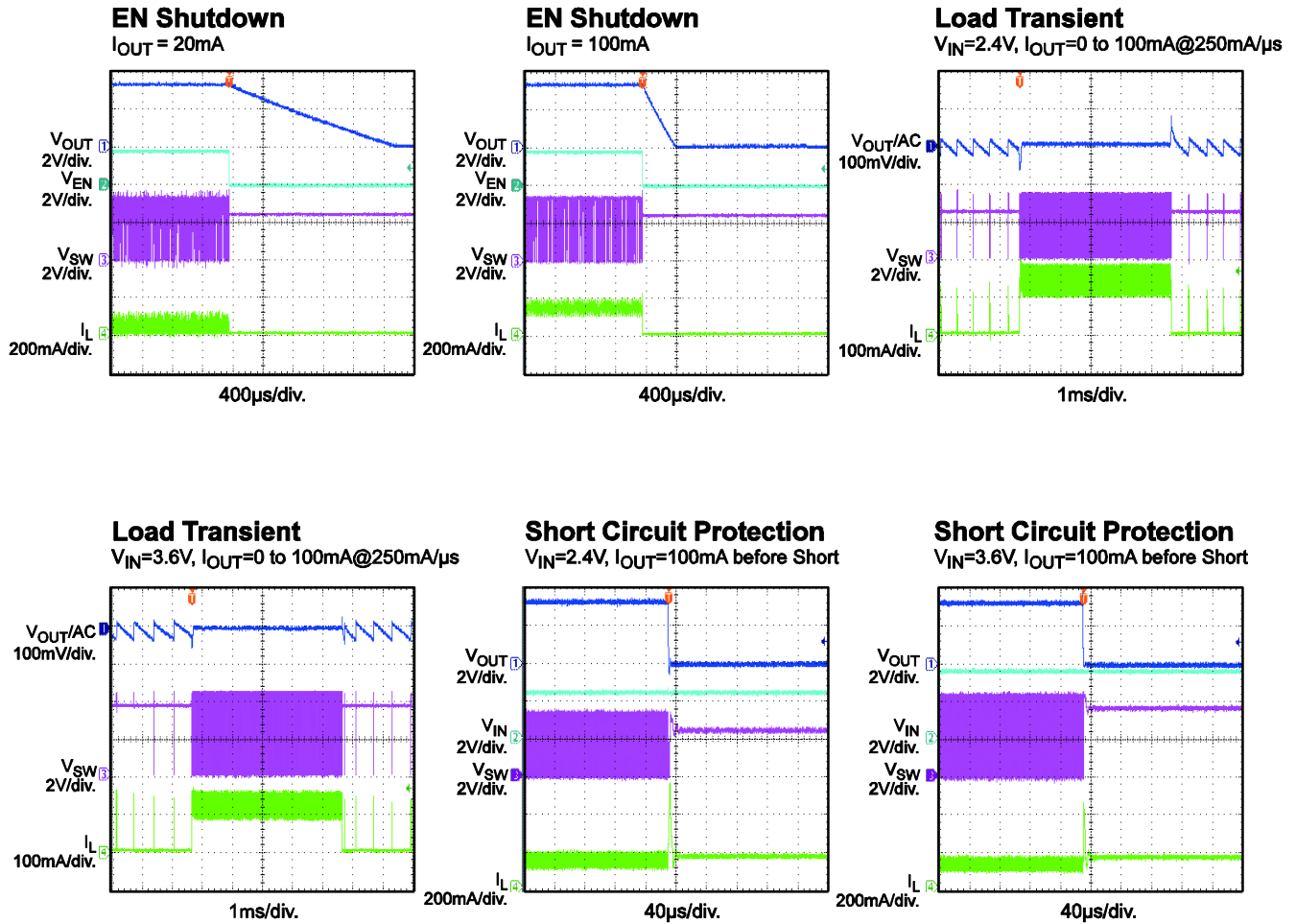

## PRINTED CIRCUIT BOARD LAYOUT

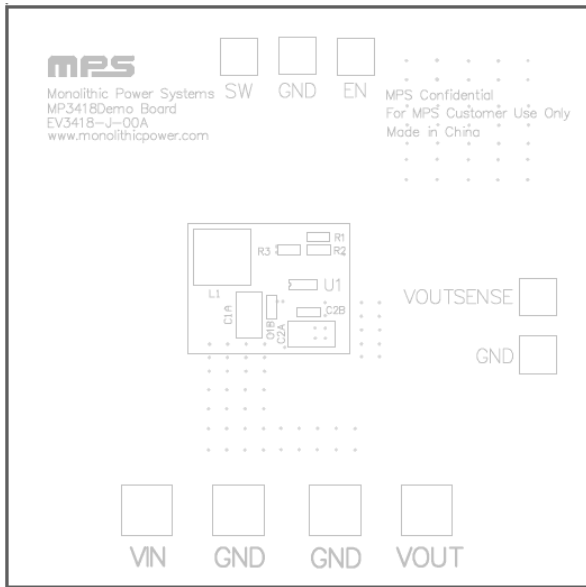

Figure 1: Top Silkscreen Layer

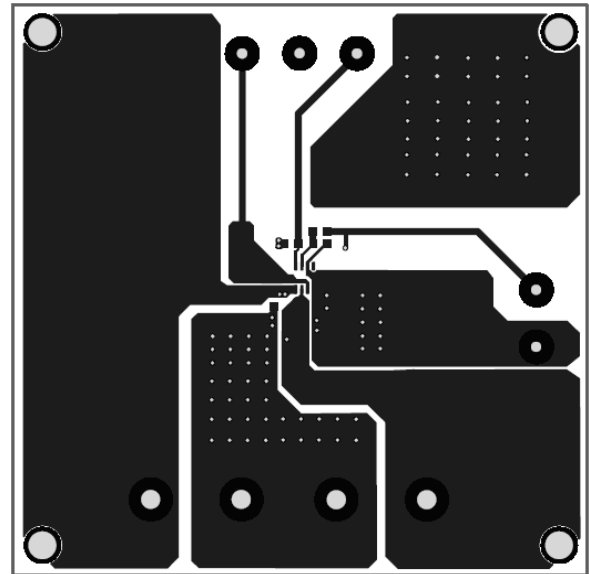

Figure 2: Top Layer

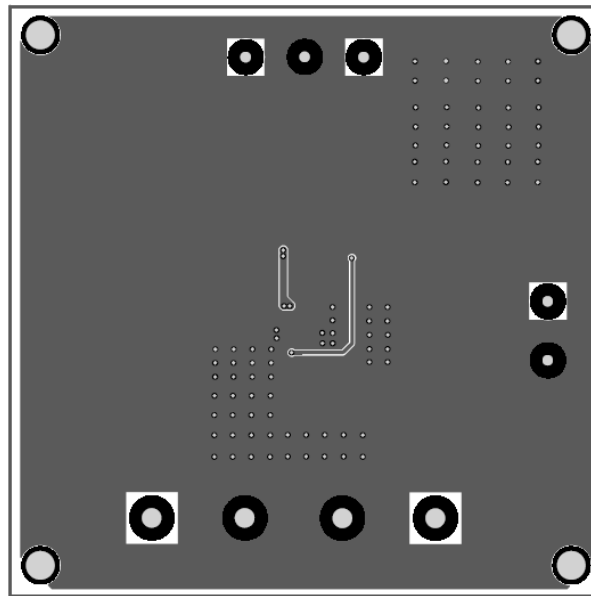

Figure 3: Bottom Layer

## QUICK START GUIDE

The output voltage of this board is set to 3.3V. The board layout accommodates most commonly used inductors and output capacitors. To use this EVB for evaluation, you can do as below:

1. Preset Power Supply to  $0.8V \leq V_{IN} \leq 4V$ .
2. Turn Power Supply off.
3. Preset Load to a value, note that over load will lead to SCP or insufficient output voltage.
4. Connect Power Supply terminals to:
  - a. Positive (+): VIN
  - b. Negative (-): GND
5. Connect Load to:
  - a. Positive (+): VOUT
  - b. Negative (-): GND
6. Turn Power Supply on after making connections. The MP3418 will automatically startup to work.
7. The output voltage  $V_{OUT}$  can be programmed by changing R2. And the value of R2 can be calculated by the following formula:  $R2 = R1 \times \frac{V_{FB}}{V_{OUT} - V_{FB}}$

Where  $V_{FB} = 1.21V$  and  $R1 = 365k\Omega$ .

8. If EN functions is preferred, apply a high level ( $V_{EN} > 0.7V$ ) turns on MP3418, low level ( $V_{EN} < 0.1V$ ) turns off MP3418. after turns off, output voltage will be discharged to 0 due to load.

**NOTICE:** The information in this document is subject to change without notice. Please contact MPS for current specifications. Users should warrant and guarantee that third party Intellectual Property rights are not infringed upon when integrating MPS products into any application. MPS will not assume any legal responsibility for any said applications.