

61ZE01RS
(ON ENVIROM) 台機理図

REFERENCE ONLY
JAE

版数 REV.	年月日 DATE	DCN NO.	変更内容 DESCRIPTION	製図 DR.	担当 CHK.	査閲 APPD.	承認 APPD.

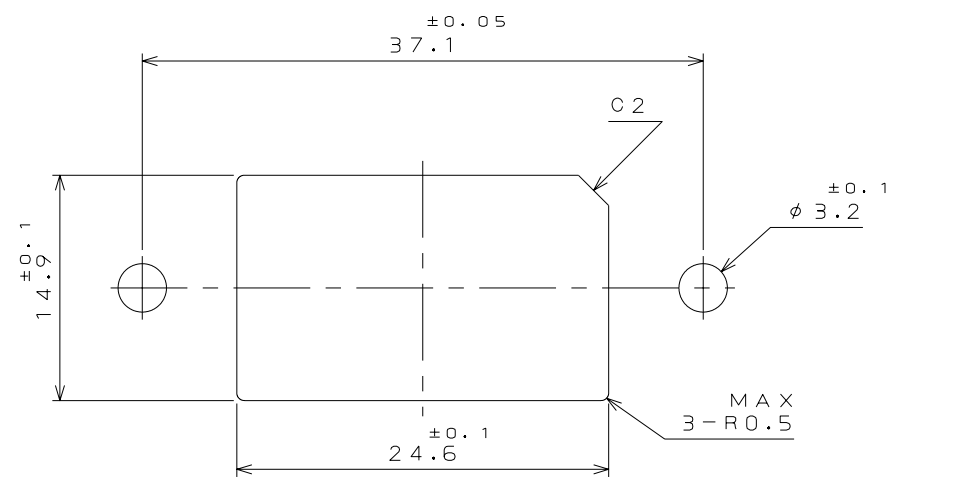
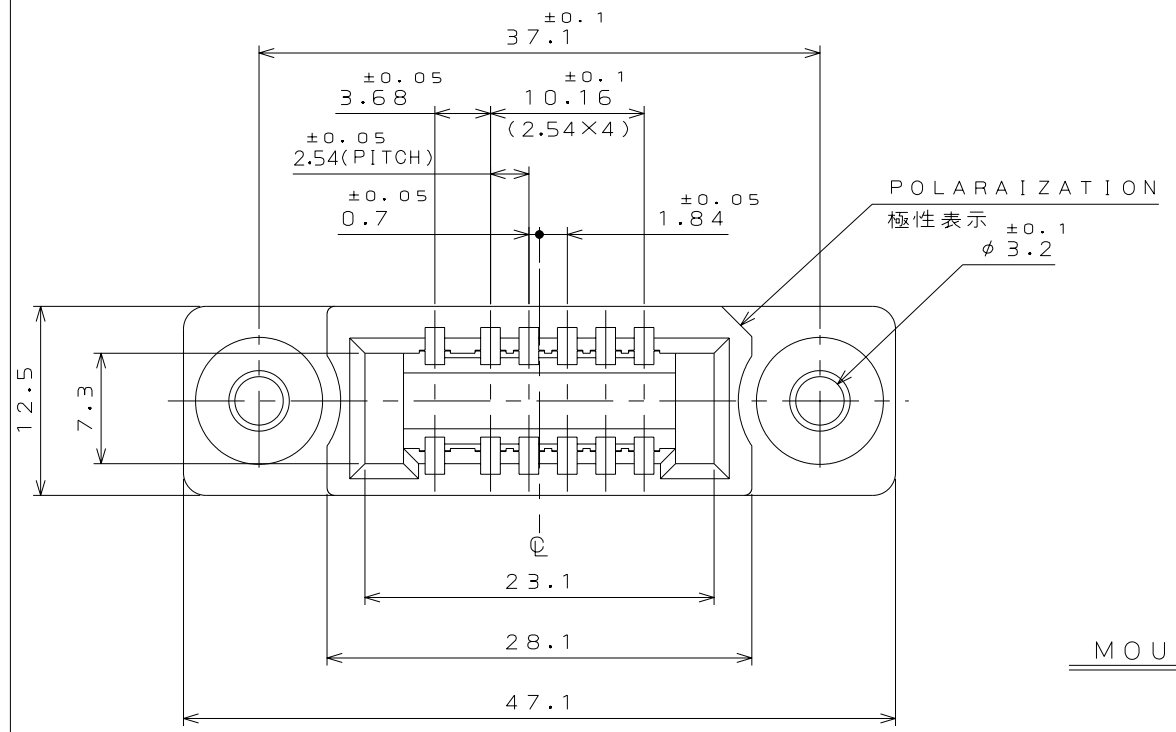

MOUNTING PANEL CUTOUT DIMENSIONS (REF.)
パネル取付穴寸法(参考)

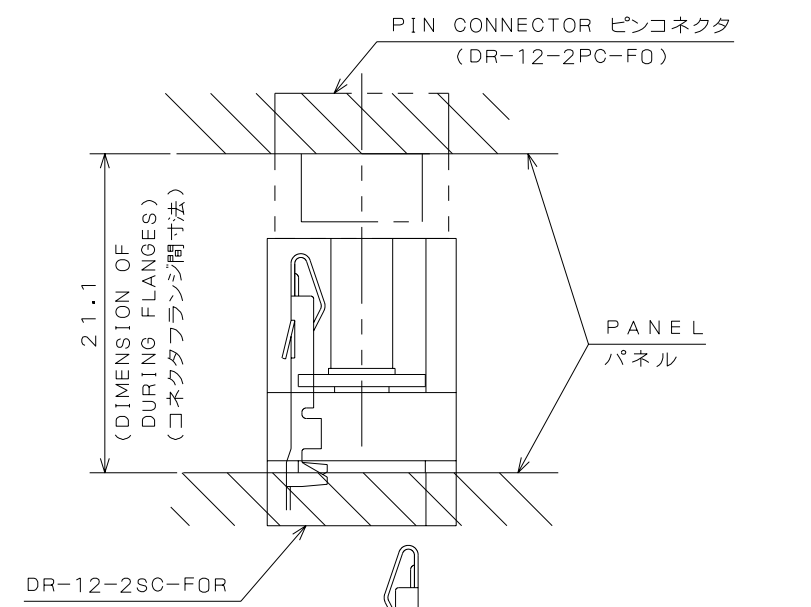

CONTACTS ARE ORDERED SEPARATELY
コンタクトは別売品です

MATED CONDITION (REF.)
嵌合状態図(参考)

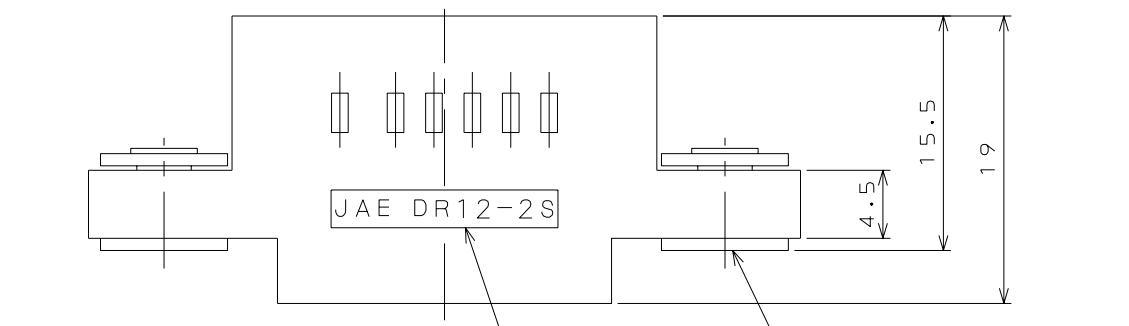

JAE AND PART No. MARKING
社標及び品名略称

FLOATING QUANTITY: ±1.0
フローティング量: ±1.0

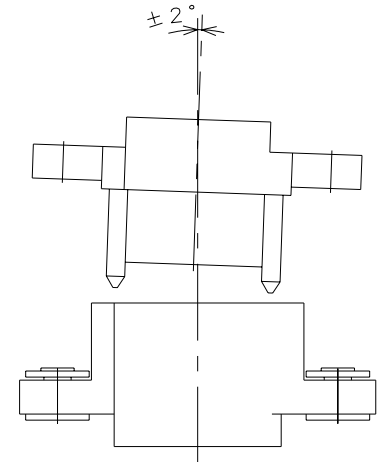
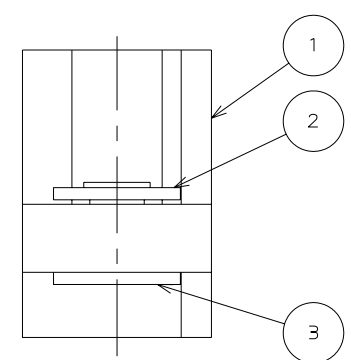

ALLOWABLE MATING ANGLE
傾き嵌合許容角度

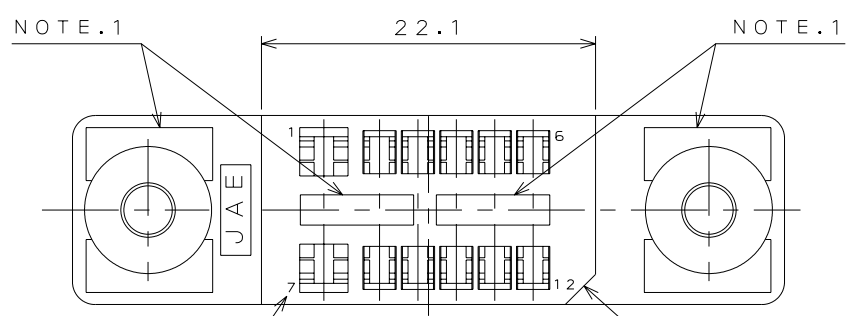

NOTE.1 ADD SHAPES IMPROVING PRODUCTIVITY.
注1. 図示の位置にヒケ逃げを設ける。

符号 NO.	名称 DESCRIPTION	個数 QTY.	材料 MATERIAL	仕上 FINISH	備考 REMARKS
3	FLOATING RIVET	2	COPPER ALLOY	NICKEL PLATED	
2	WASHER	2	COPPER ALLOY	NICKEL PLATED	
1	INSULATOR	1	GLASS FILLED PBT (COLOR: BLACK)	UL94V-0	
仕様書 (SPECIFICATION) JACS-3063-1 T86-12		第1版 (ORIGINAL DATE) 5.Jul.2005		尺度 (SCALE) 2:1	シリーズ (SERIES) DR
一般公差 (GENERAL TOLERANCE)		製図 DR.		名称 (TITLE) DR-12-2SC-F0R	
寸法 (DIMENSION)		担当 CHK. Y.TAKAGI			
角度 (ANGLES)		査閲 APPD.			
. ±0.8 .X ±0.4 .XX ±0.1 .XXX ±		承認 APPD. Y.KUBOTA			
質量 (MASS)					
					日本航空電子工業株式会社 JAPAN AVIATION ELECTRONICS INDUSTRY, LTD. 図面番号 (DRAWING NO.) SJ103219
					版数 (REV.) 1

DCF-C-212E(03.08)

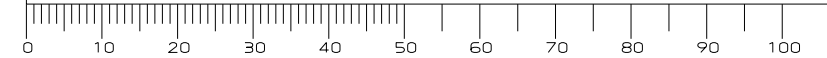

SIZE A3