

OBSOLETE - PART DISCONTINUED

## Description

The DGD21844 is a high voltage / high speed gate driver capable of driving N-Channel MOSFETs and IGBTs in a half bridge configuration. High voltage processing techniques enable the DGD21844's high-side to switch to 600V in a bootstrap operation.

The DGD21844 logic inputs are compatible with standard TTL and CMOS levels (down to 3.3V) for easy interfacing with controlling devices. The driver outputs feature high pulse current buffers designed for minimum driver cross conduction. Programmable Deadtime, by an external resistor, provides more system level flexibility.

The DGD21844 is offered in SO-14 package, the operating temperature extends from -40°C to +125°C.

## Applications

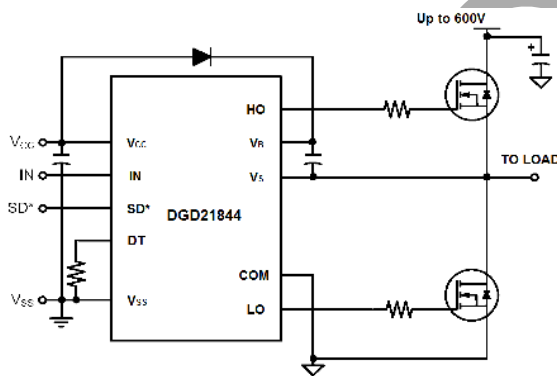
- DC-DC Converters
- DC-AC Inverters
- AC-DC Power Supplies
- Motor Controls
- Class D Power Amplifiers

## Features

- Floating High-side Driver in Bootstrap Operation to 600V
- Drives Two N-Channel MOSFETs or IGBTs in Half Bridge Configuration
- 1.4A Source / 1.8A Sink Output Current Capability
- Outputs Tolerant to Negative Transients
- Programmable Dead Time to Protect MOSFETs
- Wide Low-side Gate Driver and Logic Supply: 10V to 20V
- Wide Logic Supply Voltage Offset Voltage:-5V to 5V
- Logic Input (IN and SD\*) 3.3V Capability
- Schmitt Triggered Logic Inputs with Internal Pull Down
- Undervoltage Lockout for High and Low Side Drivers
- Extended Temperature Range: -40°C to +125°C
- **Totally Lead-Free & Fully RoHS Compliant (Notes 1 & 2)**
- **Halogen and Antimony Free. "Green" Device (Note 3)**
- **For automotive applications requiring specific change control (i.e. parts qualified to AEC-Q100/101/200, PPAP capable, and manufactured in IATF 16949 certified facilities), please [contact us](#) or your local Diodes representative.**  
<https://www.diodes.com/quality/product-definitions/>

## Mechanical Data

- Case: SO-14 (Type TH)
- Case material: Molded Plastic. "Green" Molding Compound.
- UL Flammability Classification Rating 94V-0
- Moisture Sensitivity: Level 3 per J-STD-020
- Terminals: Finish – Matte Tin Plated Leads, Solderable per MIL-STD-202, Method 208 (E3)
- Weight: 0.142 grams (Approximate)



Typical Configuration



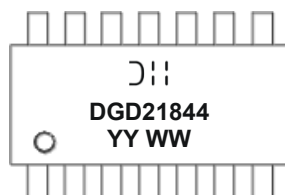
Top View

## Ordering Information (Note 4)

Part Number	Marking	Reel Size (inches)	Tape Width (mm)	Quantity per Reel
DGD21844S14-13	DGD21844	13	16	2,500

- Notes:
1. No purposely added lead. Fully EU Directive 2002/95/EC (RoHS), 2011/65/EU (RoHS 2) & 2015/863/EU (RoHS 3) compliant.
  2. See <https://www.diodes.com/quality/lead-free/> for more information about Diodes Incorporated's definitions of Halogen- and Antimony-free, "Green" and Lead-free.
  3. Halogen- and Antimony-free "Green" products are defined as those which contain <900ppm bromine, <900ppm chlorine (<1500ppm total Br + Cl) and <1000ppm antimony compounds.
  4. For packaging details, go to our website at <https://www.diodes.com/design/support/packaging/diodes-packaging/>.

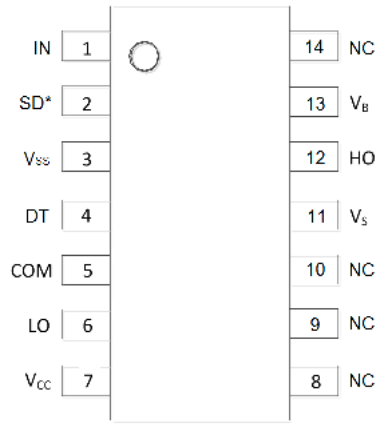
## Marking Information



Dii = Manufacturer's marking  
 DGD21844 = Product Type Marking Code  
 YY = Year (ex: 19 = 2019)  
 WW = Week (01 to 53)

OBSOLETE - PART DISCONTINUED

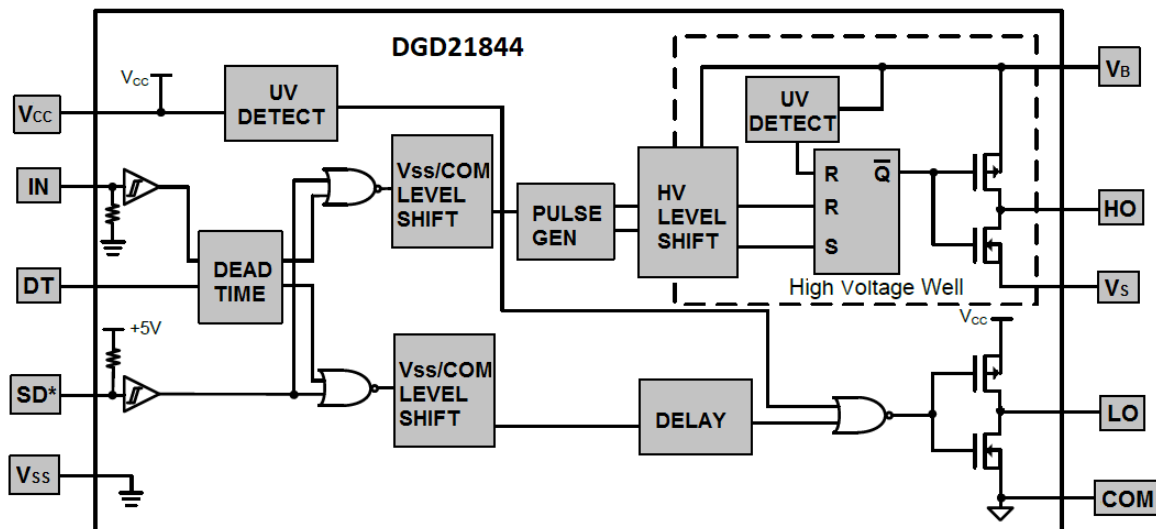
**Pin Diagrams**



**Pin Descriptions**

Pin Number	Pin Name	Function
1	IN	Logic input for high-side and low-side gate driver outputs (HO and LO), in phase with HO (referenced to V <sub>SS</sub> )
2	SD*	Logic input for shutdown (referenced to V <sub>SS</sub> ), enabled low
3	V <sub>SS</sub>	Logic ground
4	DT	Programmable Deadtime lead, referenced to V <sub>SS</sub>
5	COM	Low-side return
6	LO	Low-side gate drive output
7	V <sub>CC</sub>	Low-side and logic fixed supply
8,9,10,14	NC	No Connect (No Internal Connection)
11	V <sub>S</sub>	High-side floating supply return
12	HO	High-side gate drive output
13	V <sub>B</sub>	High-side floating supply

**Functional Block Diagram**



**Absolute Maximum Ratings** (@ $T_A = +25^\circ\text{C}$ , unless otherwise specified.)

Characteristic	Symbol	Value	Unit
High-Side Floating Supply Voltage	$V_B$	-0.3 to +624	V
High-Side Floating Supply Offset Voltage	$V_S$	$V_B - 24$ to $V_B + 0.3$	V
High-Side Floating Output Voltage	$V_{HO}$	$V_S - 0.3$ to $V_B + 0.3$	V
Offset Supply Voltage Transient	$dV_S / dt$	50	V/ns
Programmable Dead Time Pin Voltage	$V_{DT}$	$V_{SS} - 0.3$ to $V_{CC} + 0.3$	V
Logic and Low-Side Fixed Supply Voltage	$V_{CC}$	-0.3 to +24	V
Low-Side Output Voltage	$V_{LO}$	-0.3 to $V_{CC} + 0.3$	V
Logic Supply Offset Voltage	$V_{SS}$	$V_{CC} - 24$ to $V_{CC} + 0.3$	V
Logic Input Voltage (IN and SD*)	$V_{IN}$	$V_{SS} - 0.3$ to $V_{CC} + 0.3$	V

**Thermal Characteristics** (@ $T_A = +25^\circ\text{C}$ , unless otherwise specified.)

Characteristic	Symbol	Value	Unit
Power Dissipation Linear Derating Factor (Note 5)	$P_D$	1.0	W
Thermal Resistance, Junction to Ambient (Note 5)	$R_{\theta JA}$	120	$^\circ\text{C}/\text{W}$
Operating Temperature	$T_J$	+150	$^\circ\text{C}$
Lead Temperature (Soldering, 10s)	$T_L$	+300	
Storage Temperature Range	$T_{STG}$	-55 to +150	

Note: 5. When mounted on a standard JEDEC 2-layer FR-4 board.

**Recommended Operating Conditions**

Parameter	Symbol	Min	Max	Unit
High-Side Floating Supply Absolute Voltage	$V_B$	$V_S + 10$	$V_S + 20$	V
High-Side Floating Supply Offset Voltage	$V_S$	(Note 6)	600	V
High-Side Floating Output Voltage	$V_{HO}$	$V_S$	$V_B$	V
Logic and Low-Side Fixed Supply Voltage	$V_{CC}$	10	20	V
Low-Side Output Voltage	$V_{LO}$	0	$V_{CC}$	V
Logic Input Voltage (IN and SD*)	$V_{IN}$	$V_{SS}$	5	V
Programmable Dead Time Pin Voltage	$V_{DT}$	$V_{SS}$	$V_{CC}$	V
Logic Ground	$V_{SS}$	-5	5	V
Ambient Temperature	$T_A$	-40	+125	$^\circ\text{C}$

Note: 6. Logic operation for  $V_S = -5\text{V}$  to +600V.

**DC Electrical Characteristics** ( $V_{BIAS} (V_{CC}, V_{BS}) = 15V, V_{SS} = COM, @T_A = +25^\circ C$ , unless otherwise specified.) (Note 7)

Parameter	Symbol	Min	Typ	Max	Unit	Conditions
Logic "1" Input Voltage for HO & Logic "0" for LO (Note 8)	$V_{IH}$	2.5	–	–	V	$V_{CC} = 10V$ to $20V$
Logic "0" Input Voltage for HO & Logic "1" for LO (Note 8)	$V_{IL}$	–	–	0.8	V	$V_{CC} = 10V$ to $20V$
SD* Input Positive Going Threshold	$V_{SDTH+}$	2.5	–	–	V	$V_{CC} = 10V$ to $20V$
SD* Input Negative Going Threshold	$V_{SDTH-}$	–	–	0.8	V	$V_{CC} = 10V$ to $20V$
High Level Output Voltage, $V_{BIAS} - V_O$	$V_{OH}$	–	–	1.4	V	$I_O = 0mA$
Low Level Output Voltage, $V_O$	$V_{OL}$	–	–	0.2	V	$I_O = 20mA$
Offset Supply Leakage Current	$I_{LK}$	–	–	50	$\mu A$	$V_B = V_S = 600V$
Quiescent $V_{BS}$ Supply Current	$I_{BSQ}$	20	60	150	$\mu A$	$V_{IN} = 0V$ or $5V$
Quiescent $V_{CC}$ Supply Current	$I_{CCQ}$	0.4	1.0	1.8	mA	$V_{IN} = 0V$ or $5V$
Logic "1" Input Bias Current	$I_{IN+}$	–	25	60	$\mu A$	$I_N = 5V, SD^* = 0V$
Logic "0" Input Bias Current	$I_{IN-}$	–	–	1.0	$\mu A$	$I_N = 0V, SD^* = 5V$
$V_{BS}$ Supply Under-Voltage Positive Going Threshold	$V_{BSUV+}$	8.0	8.9	9.8	V	–
$V_{BS}$ Supply Under-Voltage Negative Going Threshold	$V_{BSUV-}$	7.4	8.2	9.0	V	–
$V_{CC}$ Supply Under-Voltage Positive Going Threshold	$V_{CCUV+}$	8.0	8.9	9.8	V	–
$V_{CC}$ Supply Under-Voltage Negative Going Threshold	$V_{CCUV-}$	7.4	8.2	9.0	V	–
Output High Short Circuit Pulsed Current	$I_{O+}$	1.4	1.9	–	A	$V_O = 0V, PW \leq 10\mu s$
Output Low Short Circuit Pulsed Current	$I_{O-}$	1.7	2.3	–	A	$V_O = 15V, PW \leq 10\mu s$

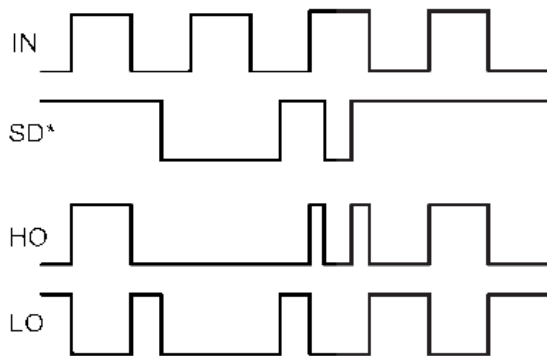
- Notes:
- The  $V_{IN}$  and  $I_{IN}$  parameters are referenced to  $V_{SS}$  and are applicable to the two logic input pins: IN and SD\*. The  $V_O$  and  $I_O$  parameters are referenced to COM and are applicable to the respective output pins: HO and LO.
  - For optimal operation, it is recommended that the input pulses (IN and SD\*) should have a minimum amplitude of 2.5V with a minimum pulse width of  $2 \times$  Deadtime ( $t_{DT}$ ).

**AC Electrical Characteristics** ( $V_{BIAS} (V_{CC}, V_{BS}) = 15V, V_{SS} = COM, C_L = 1000pF, @T_A = +25^\circ C$ , unless otherwise specified.)

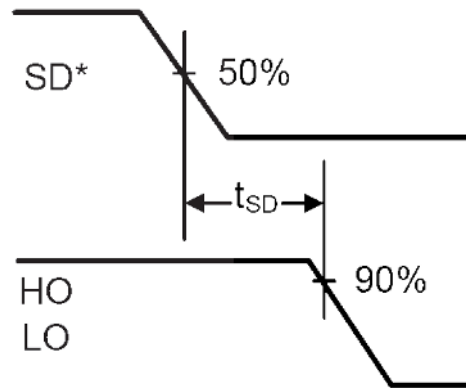
Parameter	Symbol	Min	Typ	Max	Unit	Conditions
Turn-On Propagation Delay	$t_{ON}$	–	680	900	ns	$V_S = 0V$
Turn-Off Propagation Delay	$t_{OFF}$	–	270	400	ns	$V_S = 0V$ or $600V$
Shut-Down Propagation Delay	$t_{SD}$	–	180	270	ns	–
Delay Matching, HO & LO Turn-On	$t_{DMON}$	–	–	90	ns	–
Delay Matching, HO & LO Turn-Off	$t_{DMOFF}$	–	–	40	ns	–
Turn-On Rise Time	$t_R$	–	40	60	ns	$V_S = 0V$
Turn-Off Fall Time	$t_F$	–	20	35	ns	$V_S = 0V$
Deadtime: $t_{DT LO-HO}$ & $t_{DT HO-LO}$	$t_{DT}$	280	400	520	ns	$R_{DT} = 0\Omega$
		4	5	6	$\mu s$	$R_{DT} = 200k\Omega$
Deadtime Matching = $t_{DT LO-HO} - t_{DT HO-LO}$	$t_{MDT}$	–	0	50	ns	$R_{DT} = 0\Omega$
		–	0	600	ns	$R_{DT} = 200k\Omega$

**Timing Waveforms**

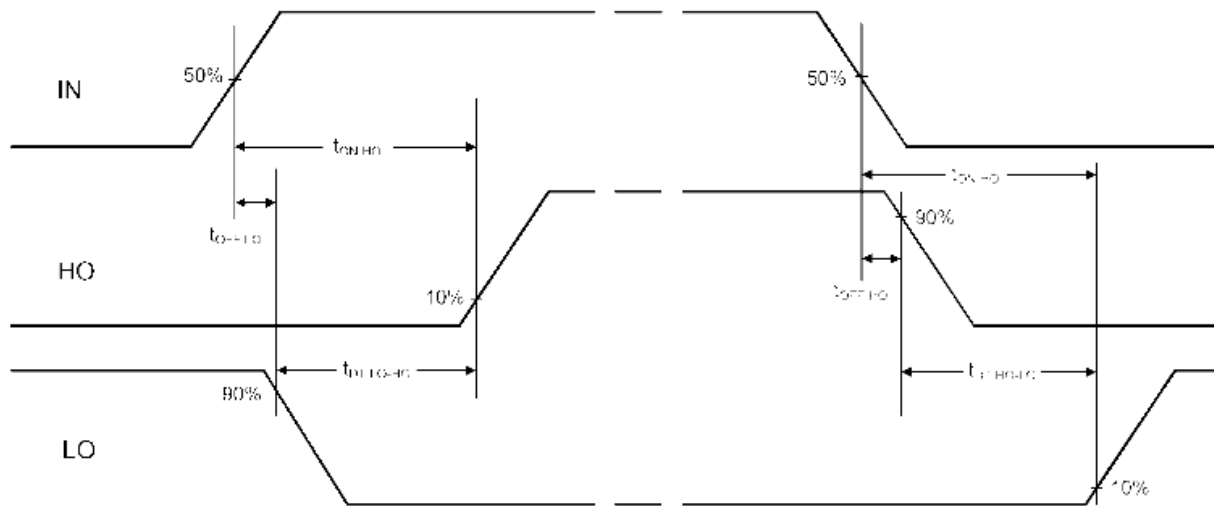
OBSOLETE - PART DISCONTINUED



**Figure 1.** Input / Output Timing Diagram



**Figure 2.** Shutdown Waveform Definitions



Deadtime  $t_{DT\ LO-HO} = t_{ON\ HO} - t_{OFF\ LO}$   
 $t_{DT\ HO-LO} = t_{ON\ LO} - t_{OFF\ HO}$

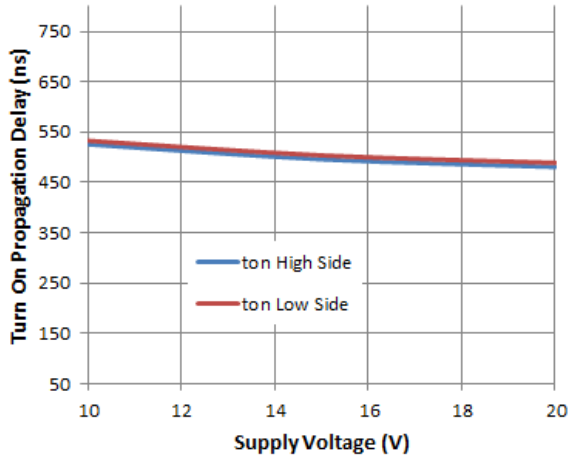
Deadtime matching  
 $t_{MDT} = t_{DT\ LO-HO} - t_{DT\ HO-LO}$

Delay matching  
 $t_{DM\ OFF} = t_{OFF\ LO} - t_{OFF\ HO}$

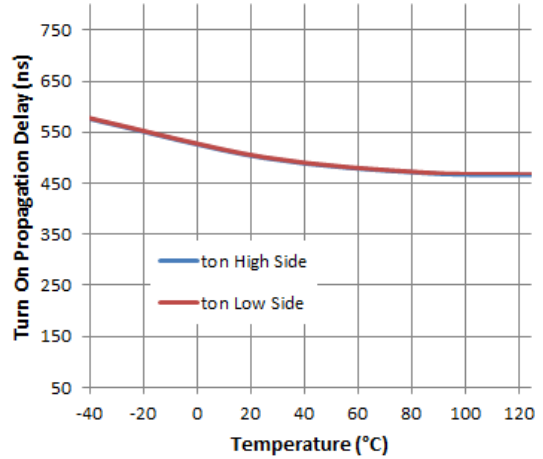
**Figure 3.** Switching Time Waveform Definitions

**Typical Performance Characteristics** ( $V_{CC}=15V$ ,  $@T_A = +25^\circ C$ , unless otherwise specified.)

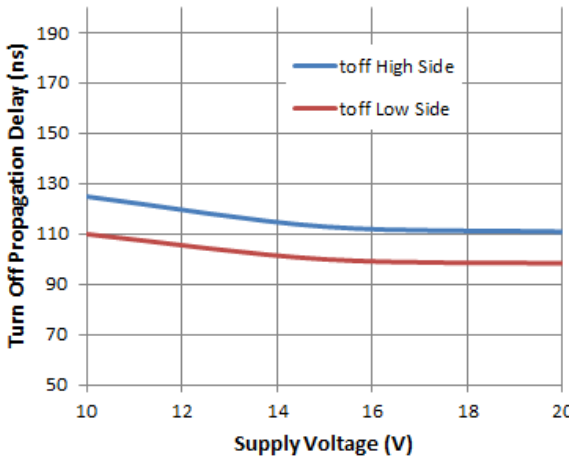
OBSOLETE – PART DISCONTINUED



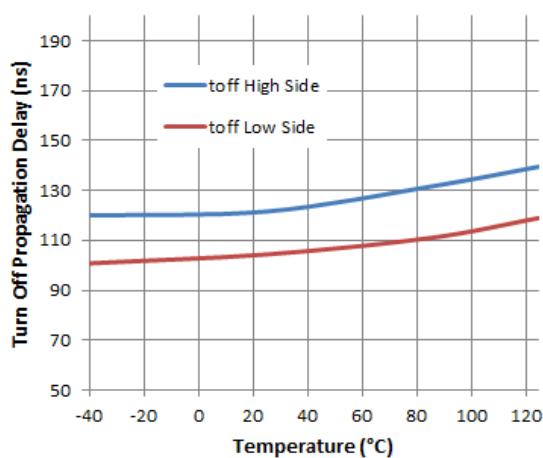
**Figure 4.** Turn-on Propagation Delay vs. Supply Voltage



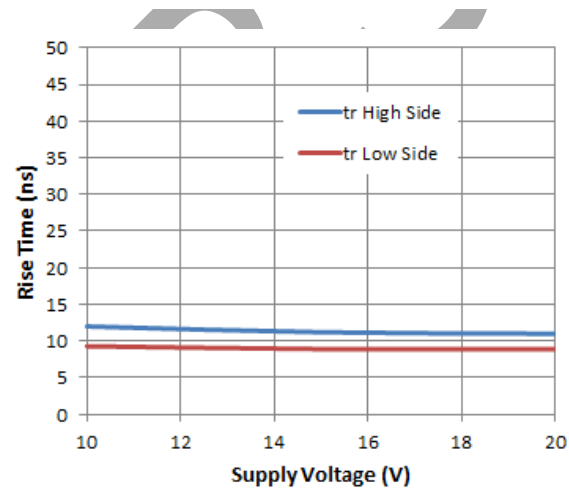
**Figure 5.** Turn-on Propagation Delay vs. Temperature



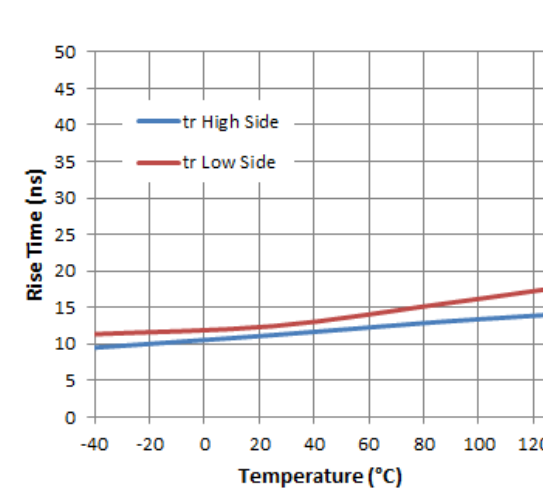
**Figure 6.** Turn-off Propagation Delay vs. Supply Voltage



**Figure 7.** Turn-off Propagation Delay vs. Temperature



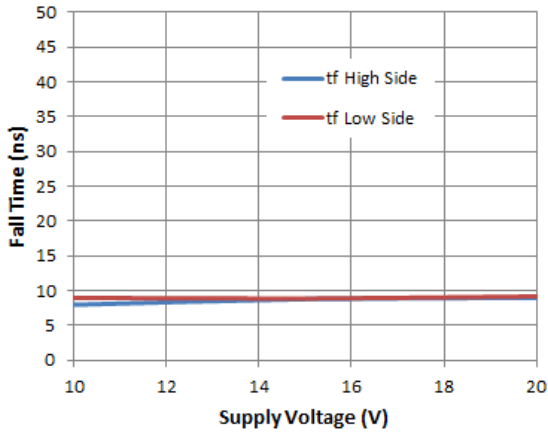
**Figure 8.** Rise Time vs. Supply Voltage



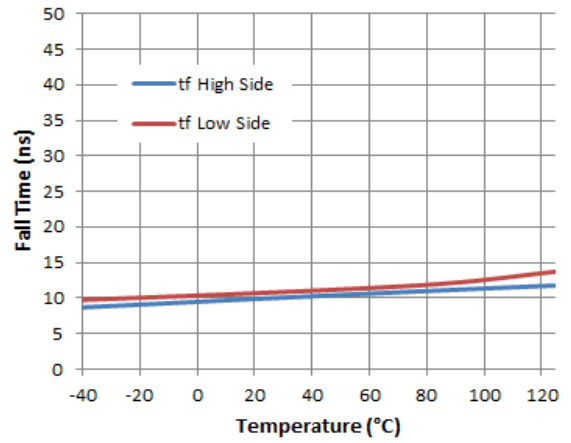
**Figure 9.** Rise Time vs. Temperature

OBSOLETE - PART DISCONTINUED

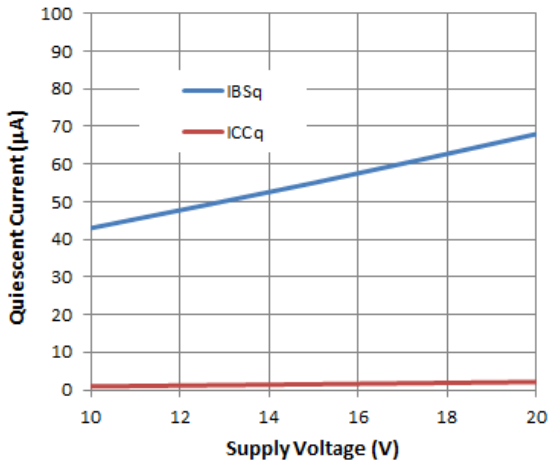
**Typical Performance Characteristics** (continued)



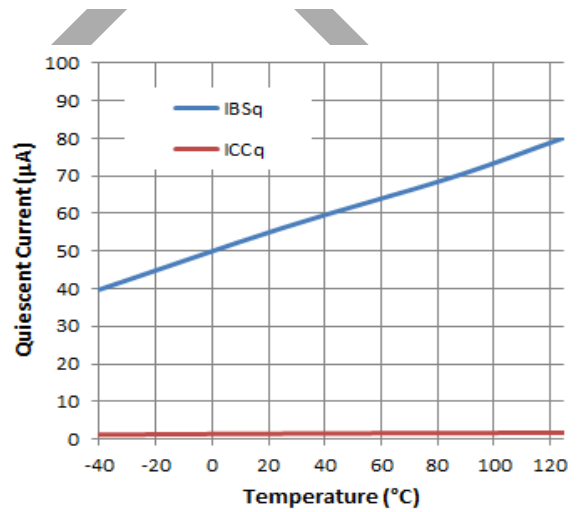
**Figure 10.** Fall Time vs. Supply Voltage



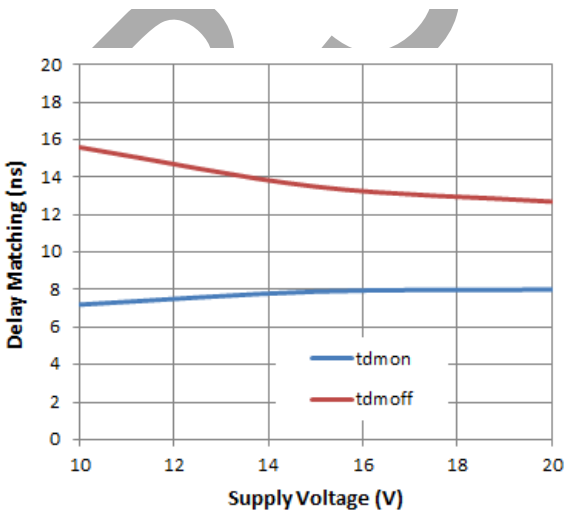
**Figure 11.** Fall Time vs. Temperature



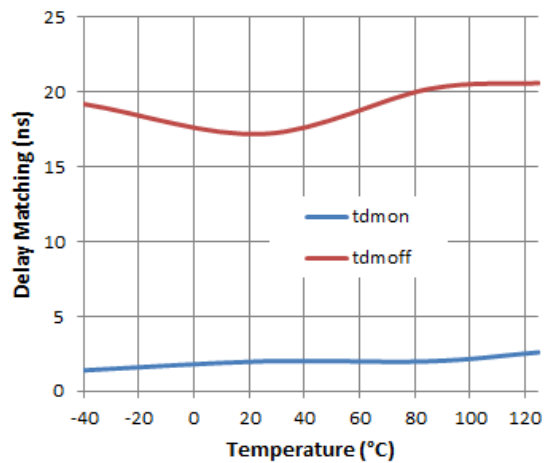
**Figure 12.** Quiescent Current vs. Supply Voltage



**Figure 13.** Quiescent Current vs. Temperature



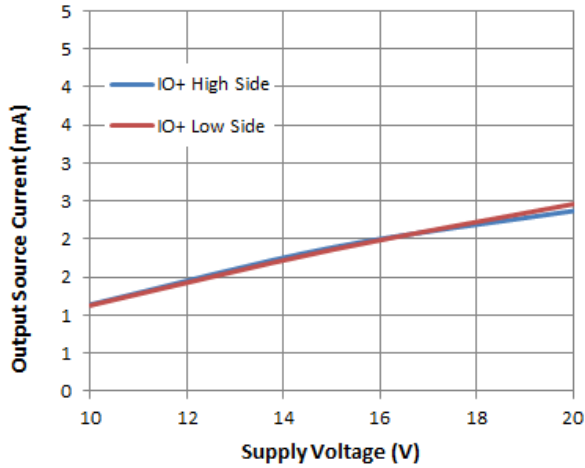
**Figure 14.** Delay Matching vs. Supply Voltage



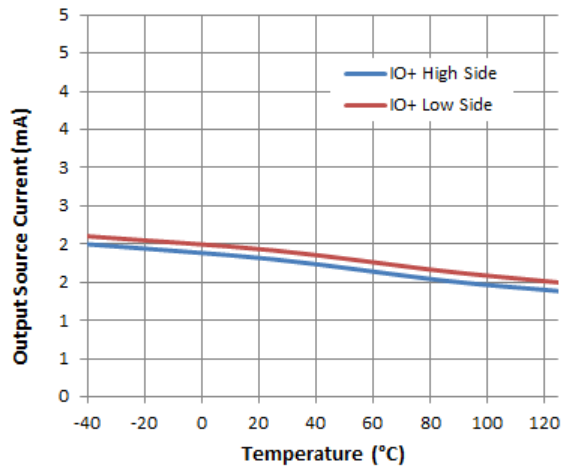
**Figure 15.** Delay Matching vs. Temperature

**Typical Performance Characteristics** (continued)

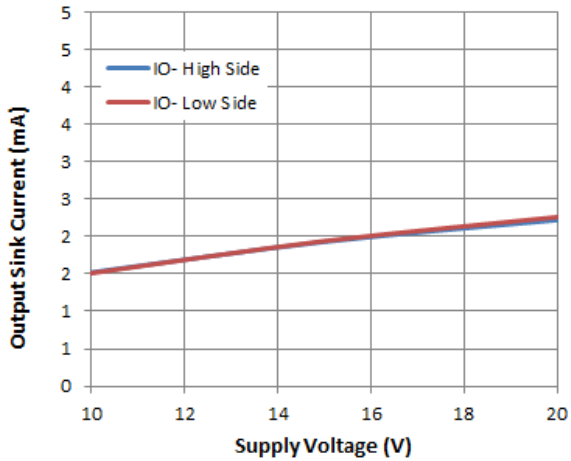
OBSOLETE – PART DISCONTINUED



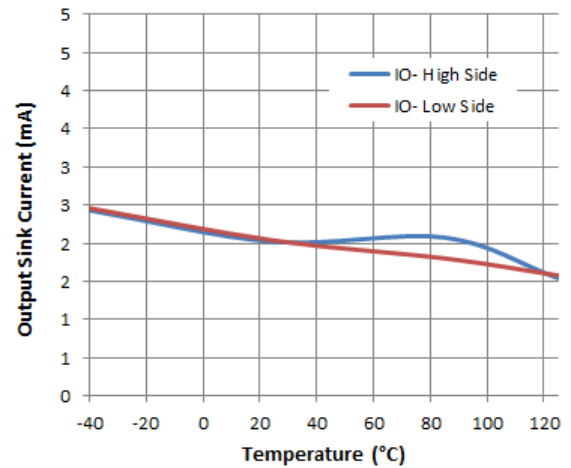
**Figure 16.** Output Source Current vs. Supply Voltage



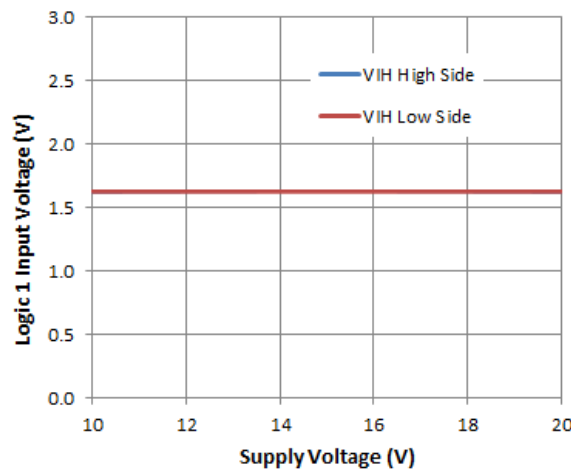
**Figure 17.** Output Source Current vs. Temperature



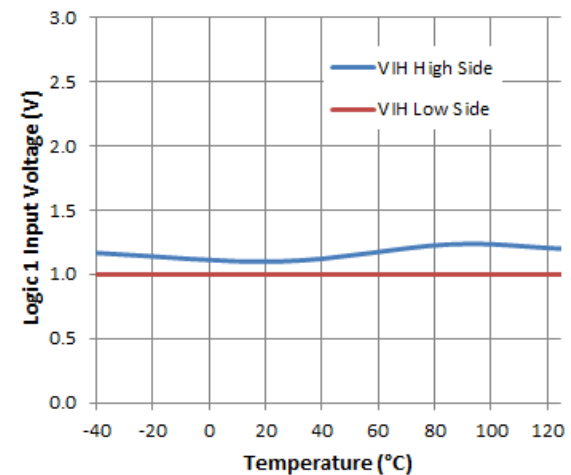
**Figure 18.** Output Sink Current vs. Supply Voltage



**Figure 19.** Output Sink Current vs. Temperature



**Figure 20.** Logic 1 Input Voltage vs. Supply Voltage

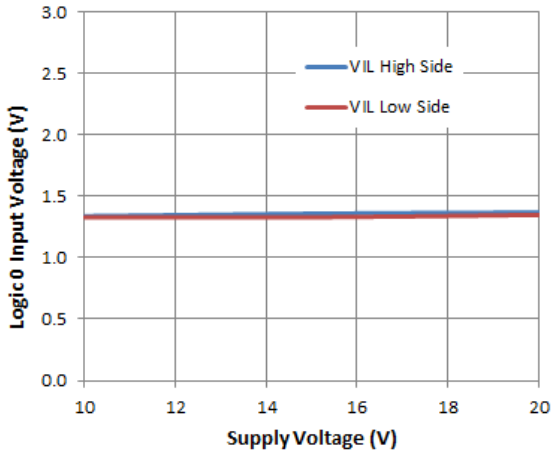


**Figure 21.** Logic 1 Input Voltage vs. Temperature

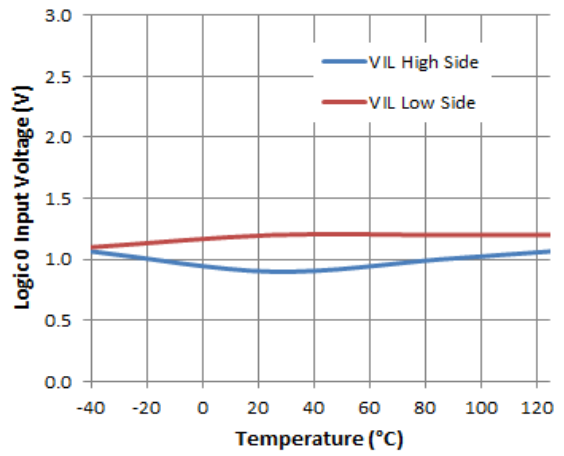


**Typical Performance Characteristics** (continued)

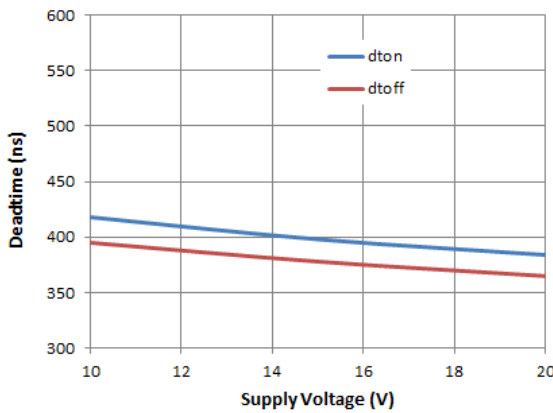
OBSOLETE – PART DISCONTINUED



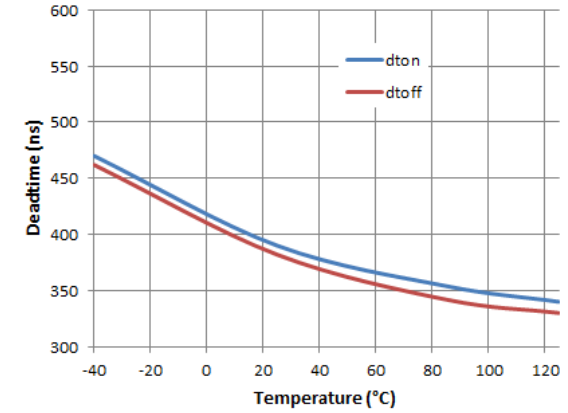
**Figure 22.** Logic 0 Input Voltage vs. Supply Voltage



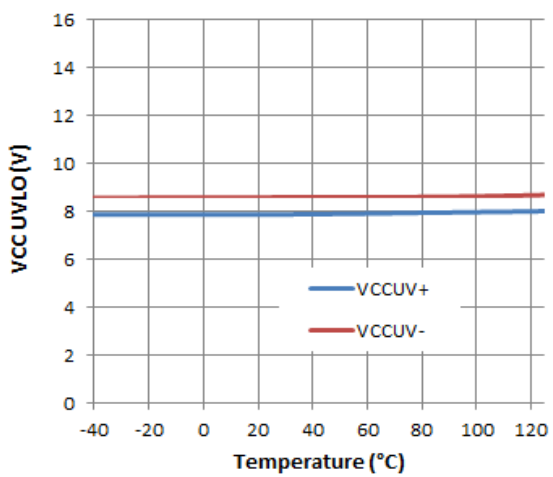
**Figure 23.** Logic 0 Input Voltage vs. Temperature



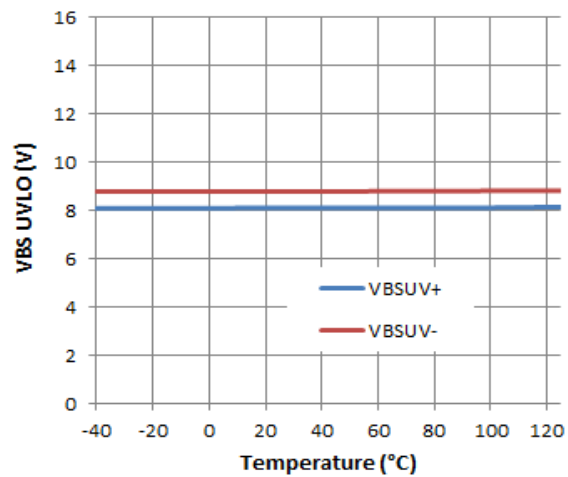
**Figure 24.** Deadtime vs. Supply Voltage



**Figure 25.** Deadtime vs. Temperature

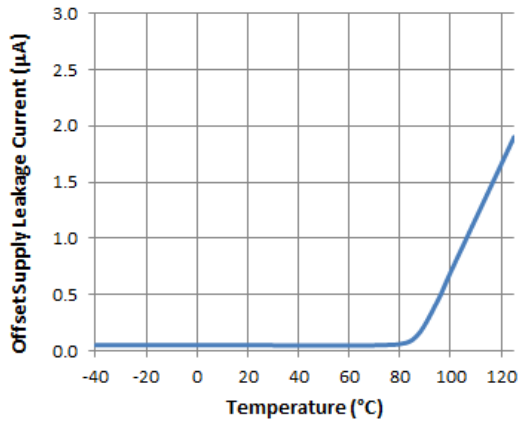


**Figure 26.** VCC UVLO vs. Temperature



**Figure 27.** VBS UVLO vs. Temperature

**Typical Performance Characteristics** (continued)



**Figure 28.** Offset Supply Leakage Current vs. Temperature

OBSOLETE

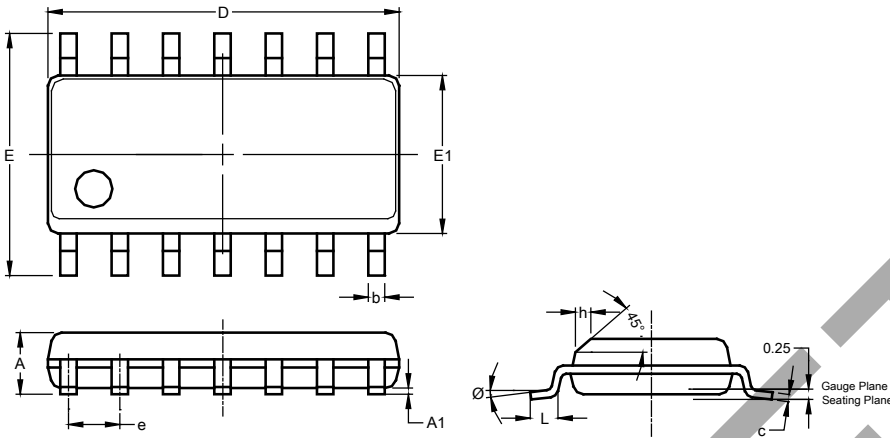
OBSOLETE – PART DISCONTINUED

OBSOLETE - PART DISCONTINUED

**Package Outline Dimensions**

Please see <http://www.diodes.com/package-outlines.html> for the latest version.

**SO-14 (Type TH)**

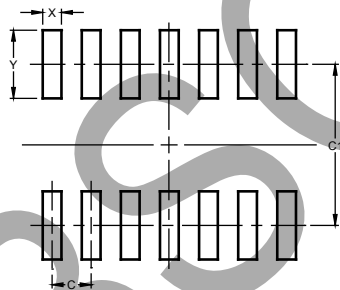


SO-14 (Type TH)			
Dim	Min	Max	Typ
A	1.55	1.73	--
A1	0.10	0.25	--
b	0.35	0.51	--
c	0.190	0.248	--
D	8.56	8.74	8.61
E	5.84	6.20	6.00
E1	3.81	3.99	3.94
e	--	--	1.27
h	--	--	0.33
L	0.41	0.89	--
Ø	0°	8°	--
All Dimensions in mm			

**Suggested Pad Layout**

Please see <http://www.diodes.com/package-outlines.html> for the latest version.

**SO-14 (Type TH)**



Dimensions	Value (in mm)
C	1.27
C1	5.20
X	0.60
Y	2.20

Note: For high voltage applications, the appropriate industry sector guidelines should be considered with regards to creepage and clearance distances between device Terminals and PCB tracking.

**IMPORTANT NOTICE**

1. DIODES INCORPORATED AND ITS SUBSIDIARIES ("DIODES") MAKE NO WARRANTY OF ANY KIND, EXPRESS OR IMPLIED, WITH REGARDS TO ANY INFORMATION CONTAINED IN THIS DOCUMENT, INCLUDING, BUT NOT LIMITED TO, THE IMPLIED WARRANTIES OF MERCHANTABILITY, FITNESS FOR A PARTICULAR PURPOSE OR NON-INFRINGEMENT OF THIRD PARTY INTELLECTUAL PROPERTY RIGHTS (AND THEIR EQUIVALENTS UNDER THE LAWS OF ANY JURISDICTION).
2. The Information contained herein is for informational purpose only and is provided only to illustrate the operation of Diodes products described herein and application examples. Diodes does not assume any liability arising out of the application or use of this document or any product described herein. This document is intended for skilled and technically trained engineering customers and users who design with Diodes products. Diodes products may be used to facilitate safety-related applications; however, in all instances customers and users are responsible for (a) selecting the appropriate Diodes products for their applications, (b) evaluating the suitability of the Diodes products for their intended applications, (c) ensuring their applications, which incorporate Diodes products, comply the applicable legal and regulatory requirements as well as safety and functional-safety related standards, and (d) ensuring they design with appropriate safeguards (including testing, validation, quality control techniques, redundancy, malfunction prevention, and appropriate treatment for aging degradation) to minimize the risks associated with their applications.
3. Diodes assumes no liability for any application-related information, support, assistance or feedback that may be provided by Diodes from time to time. Any customer or user of this document or products described herein will assume all risks and liabilities associated with such use, and will hold Diodes and all companies whose products are represented herein or on Diodes' websites, harmless against all damages and liabilities.
4. Products described herein may be covered by one or more United States, international or foreign patents and pending patent applications. Product names and markings noted herein may also be covered by one or more United States, international or foreign trademarks and trademark applications. Diodes does not convey any license under any of its intellectual property rights or the rights of any third parties (including third parties whose products and services may be described in this document or on Diodes' website) under this document.
5. Diodes products are provided subject to Diodes' Standard Terms and Conditions of Sale (<https://www.diodes.com/about/company/terms-and-conditions/terms-and-conditions-of-sales/>) or other applicable terms. This document does not alter or expand the applicable warranties provided by Diodes. Diodes does not warrant or accept any liability whatsoever in respect of any products purchased through unauthorized sales channel.
6. Diodes products and technology may not be used for or incorporated into any products or systems whose manufacture, use or sale is prohibited under any applicable laws and regulations. Should customers or users use Diodes products in contravention of any applicable laws or regulations, or for any unintended or unauthorized application, customers and users will (a) be solely responsible for any damages, losses or penalties arising in connection therewith or as a result thereof, and (b) indemnify and hold Diodes and its representatives and agents harmless against any and all claims, damages, expenses, and attorney fees arising out of, directly or indirectly, any claim relating to any noncompliance with the applicable laws and regulations, as well as any unintended or unauthorized application.
7. While efforts have been made to ensure the information contained in this document is accurate, complete and current, it may contain technical inaccuracies, omissions and typographical errors. Diodes does not warrant that information contained in this document is error-free and Diodes is under no obligation to update or otherwise correct this information. Notwithstanding the foregoing, Diodes reserves the right to make modifications, enhancements, improvements, corrections or other changes without further notice to this document and any product described herein. This document is written in English but may be translated into multiple languages for reference. Only the English version of this document is the final and determinative format released by Diodes.
8. Any unauthorized copying, modification, distribution, transmission, display or other use of this document (or any portion hereof) is prohibited. Diodes assumes no responsibility for any losses incurred by the customers or users or any third parties arising from any such unauthorized use.

Copyright © 2021 Diodes Incorporated

[www.diodes.com](http://www.diodes.com)

OBsolete - PART DISCONTINUED