

Unit:mm Tolerance: ±1 Color :black

PRODUCT OUTLINE DIMENSION :

Global 2C+1A 3ports Interchangeable AC PLUG (Black House)

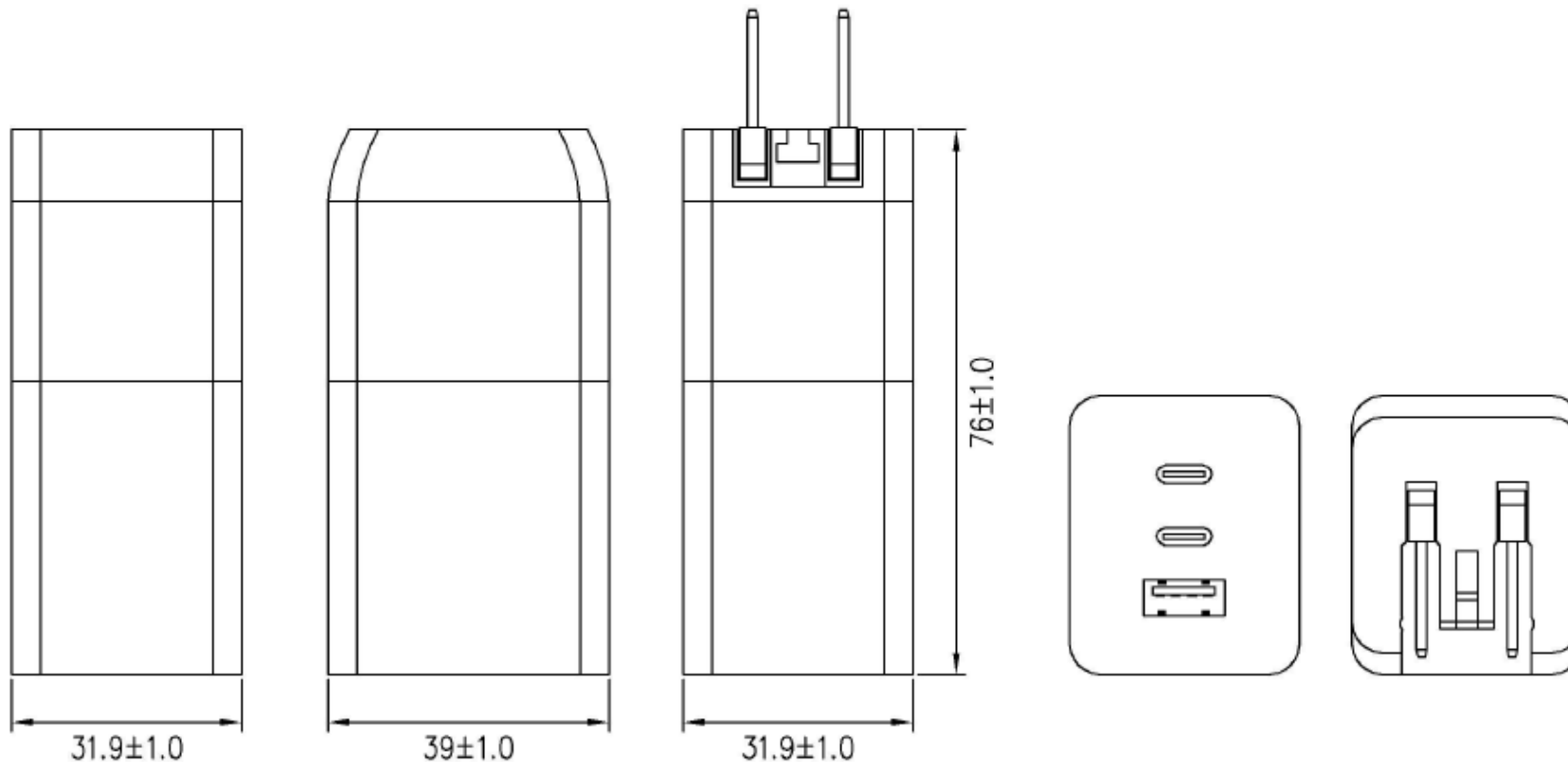

Shell material: PC Temperature Resistance:120 °C/ temperature resistance 120 °C
 PC+ABS Temperature Resistance: 95 °C/ temperature resistance 95 °C
 REMARK : PC material meets the requirement of spherical pressure test.

Ltem	QTY	Specifications	P/N
1	1PCS	LABEL	000-0000
2	1PCS	LABEL	000-0000
3	1PCS	LABEL	TBD

PROJECTION

SCALE
N/A

TITLE
Interchangeable 65W GaN USB charger, RoHS Compliant

DR. Tina **DATE** 03/20/23 **REF.** P/N: MK-PG651EXC2A-NL **SHEET** 1 OF 6

CK. BM **PRE-PS** **DRAWING NO.** 5353 **SIZE** F **REV.** _

DEC. MILLIMETERS
0.00±0.25mm
0.0±0.40mm
0±1.00mm

ANG. N/A

THIS DOCUMENT IS OWNED BY, AND THE INFORMATION CONTAINED IN IT IS PROPRIETARY TO, RDI, BY RECEIPT HEREOF THE HOLDER AGREES NOT TO USE THE INFORMATION AND NOT TO DISCLOSE IT TO ANY THIRD PARTY, NOR REPRODUCE THIS DOCUMENT WITHOUT THE WRITTEN CONSENT OF RDI, AND AGREES TO RETURN THIS DOCUMENT FORTHWITH UPON REQUEST.

ECN#	DATE	SYM	REVISION RECORD	AUTH	BY

SPECIFICATION FOR APPROVAL

SAA REMOVABLE

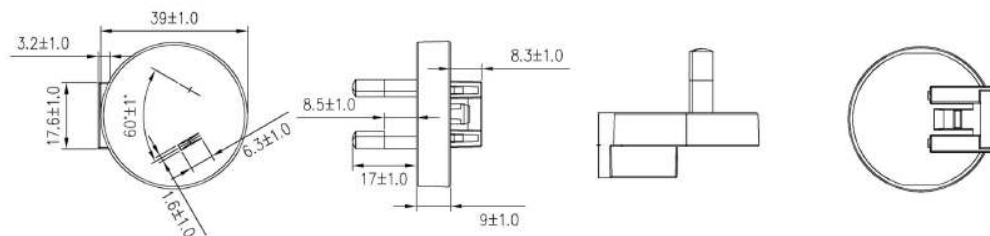

CE REMOVABLE

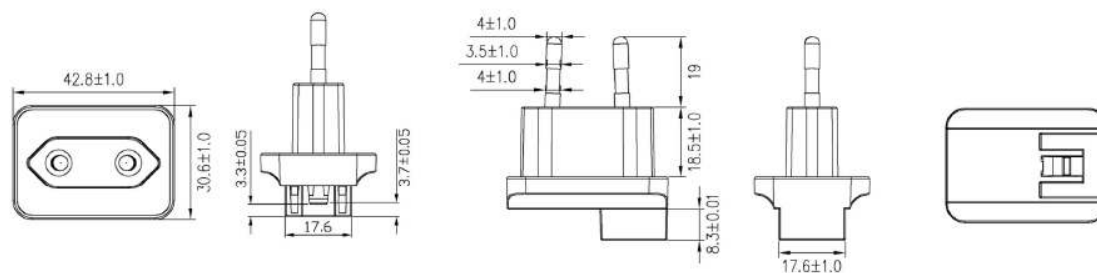

BS REMOVABLE

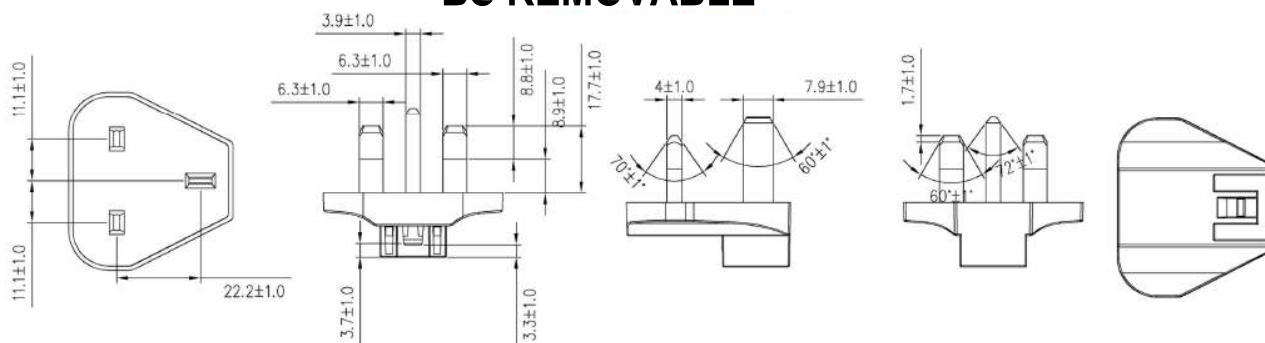

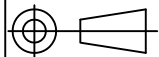
PROJECTION		 Research Develop Innovate RDI, Inc. 333 North Bedford Road, Suite 135, Mount Kisco, NY 10549			
					
SCALE N/A		TITLE Interchangeable 65W GaN USB charger, RoHS Compliant			
TOLERANCE EXCEPT AS NOTED		DR. Tina	DATE 03/20/23	REF. P/N: MK-PG651EXC2A-NL	SHEET 2 OF 6
DEC. MILLIMETERS 0.00±0.25mm 0±0.40mm 0±1.00mm		CK. BM	PRE- PS	DRAWING NO. 5353	SIZE F
ANG. N/A		THIS DOCUMENT IS OWNED BY, AND THE INFORMATION CONTAINED IN IT IS PROPRIETARY TO, RDI, BY RECEIPT HEREOF THE HOLDER AGREES NOT TO USE THE INFORMATION AND NOT TO DISCLOSE IT TO ANY THIRD PARTY, NOR REPRODUCE THIS DOCUMENT WITHOUT THE WRITTEN CONSENT OF RDI, AND AGREES TO RETURN THIS DOCUMENT FORTHWITH UPON REQUEST.			

ECN#	DATE	SYM	REVISION RECORD	AUTH	BY
------	------	-----	-----------------	------	----

SPECIFICATION FOR APPROVAL

1. SCOPE:

This product is a consumer product. It can be used for intelligent identification and charging of Bluetooth devices, mobile phones, tablets and other digital electronic products. It is an AC to DC converter with combination of portable travel charger.

1.1. Description

- USB CHARGER/ USB / Fixed AC PLUG
- USB CHARGER/ USB / Interchangeable AC PLUG

2. INPUT CHARACTERISTICS

- 2.1 * Input voltage range : 90Vac - 264Vac
- 2.2 * Normal voltage range : 100Vac - 240Vac
- 2.3 * Input frequency range : 47Hz-63Hz
- 2.4 * Rated input frequency : 50Hz/60Hz
- 2.5 * Max.input ac current : 1.5Amax. at full load condition
- 2.6 Inrush current(cold start): 80Amax. @ 264Vac input
- 2.7 * Efficiency(Average) 25%, 50%, 75%, 100% \geq 88.0% : At 115/230Vac.
- 2.8 * No-load power(At 115VAC/230VC: Less than 0.21W

3. OUTPUT CHARACTERISTICS

3.1 * Test project

	Port output /输出	Min. voltage (V)	Standard voltage (V)	Max. voltage (V)	Standard current (A)	OCP (A)
Type-C1 or C2 (Each 65W)	5V Voltage /电压	4.75	5.0	5.25	3.0	3.2-3.8
	9V Voltage /电压	8.55	9.0	9.45	3.0	3.2-3.8
	12V Voltage /电压	11.4	12.0	12.6	3.0	3.2-3.8
	15V Voltage /电压	14.25	15.00	15.75	3.0	3.2-3.8
	20V Voltage /电压	19.0	20.00	21.0	3.25	3.2-3.8
	Output 20V/3.25A The line that needs to output Type-C contains E-MARK chip. Otherwise, only 20V/3A can be output.					
Type-C1 (45W)	5V Voltage /电压	4.75	5.0	5.25	3.0	3.2-3.8
	9V Voltage /电压	8.55	9.0	9.45	3.0	3.2-3.8
	12V Voltage /电压	11.4	12.0	12.6	3.0	3.2-3.8
	15V Voltage /电压	14.25	15.00	15.75	3.0	3.2-3.8
	20V Voltage /电压	19.0	20.00	21.0	2.25	3.2-3.8

Type-C2 (18W)	5V Voltage /电压	4.75	5.0	5.25	3.0	3.2-3.8
	9V Voltage /电压	8.55	9.0	9.45	2.0	3.2-3.8
	12V Voltage /电压	11.4	12.0	12.6	1.5	1.7-2.3

3.2 * Test project

	Port output /输出	Min. voltage (V)	Standard voltage (V)	Max. voltage (V)	Standard current (A)	OCP (A)
USB A (65W)	5V Voltage /电压	4.75	5.0	5.25	3.0	3.2-3.8
	9V Voltage /电压	8.55	9.0	9.45	3.0	3.2-3.8
	12V Voltage /电压	11.4	12.0	12.6	3.0	3.2-3.8
	15V Voltage /电压	14.25	15.00	15.75	3.0	3.2-3.8
	20V Voltage /电压	19.0	20.00	21.0	3.25	3.2-3.8
	USB A (18W)	5V Voltage /电压	4.75	5.0	5.25	3.0
9V Voltage /电压		8.55	9.0	9.45	2.0	2.2-2.8
12V Voltage /电压		11.4	12.0	12.6	1.5	1.7-2.5
Type-C2 / USB A (15W)	5V Voltage /电压	4.75	5.0	5.25	3.0	3.2-3.8

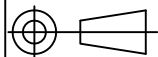
PROJECTION		 Research Develop Innovate RDI, Inc. 333 North Bedford Road, Suite 135, Mount Kisco, NY 10549			
					
SCALE N/A		TITLE Interchangeable 65W GaN USB charger, RoHS Compliant			
TOLERANCE EXCEPT AS NOTED		DR. Tina	DATE 03/20/23	REF. P/N: MK-PG651EXC2A-NL	SHEET 3 OF 6
DEC. MILLIMETERS 0.00±0.25mm 0.0±0.40mm 0±1.00mm		CK. BM	PRE-PS	DRAWING NO. 5353	SIZE F
ANG. N/A		THIS DOCUMENT IS OWNED BY, AND THE INFORMATION CONTAINED IN IT IS PROPRIETARY TO, RDI, BY RECEIPT HEREOF THE HOLDER AGREES NOT TO USE THE INFORMATION AND NOT TO DISCLOSE IT TO ANY THIRD PARTY, NOR REPRODUCE THIS DOCUMENT WITHOUT THE WRITTEN CONSENT OF RDI, AND AGREES TO RETURN THIS DOCUMENT FORTHWITH UPON REQUEST.			

ECN#	DATE	SYM	REVISION RECORD	AUTH	BY

SPECIFICATION FOR APPROVAL

3.3 * Test project

Type-C1+Type-C2+USB A

Type-C1	Type-C2	USB A	TOTAL
65.0W	NC	NC	65.0W
NC	65.0W	NC	65.0W
45.0W	18.0W	NC	63.0W
45.0W	NC	18.0W	63.0W
NC	NC	22.5W	22.5W
45.0W	15.0W(3口同时使用, USB C2和USB A共享5V 3A)		60.0W

3.4 * Test project

port output	Remarks
Single port short circuit protection	Any one short circuit will enter the hiccup protection mode, and the short circuit will automatically resume after disappearing.
Total output power	Total \leq 65W
Turn on delay time	2S max. @ 115Vac to 230Vac input & Full load/
Rise time	40mS Max.at 115Vac input and output Max load.
Hold up time	a.5mS min. @ Full load &115Vac/60Hz input turn off at worst case b.10mS min. @ Full load &230Vac/50Hz input turn off at worst case
Output Overshoot / Undershoot	15% Max.When power supply at turn off/on.
Output Load Transient Response	Output voltage within \pm 5% for load step from 25% to 50% to 25%,50% to 75% to 50% R/S: 0.25A/uS, Transient Response Recovery Time :200uS, Dynamic response overshoot 5%
Over voltage protection	The output voltage shall be clamped by internal protection IC
Over temperature protection	IC requires built-in over-temperature protection. When IC temperature exceeds 135 degrees, it must stop output automatically.
Total output short circuit power	When the output is short circuit, the power is less than 5W, but it will not damage the product. After the short circuit disappears, it will return to normal automatically.

3.5 Charging Protocol & Intelligent Identification

USB C:	USB A:
<input checked="" type="checkbox"/> Support Apple 2.4A and DCP 1.5A	<input checked="" type="checkbox"/> Support Apple 2.4A and DCP 1.5A
<input checked="" type="checkbox"/> Support PD3.0 or PD2.0	<input checked="" type="checkbox"/> Support QC4.0+/QC3.0/QC3.0/QC2.0
<input checked="" type="checkbox"/> Support AFC / FCP	<input checked="" type="checkbox"/> Support AFC / FCP/ SCP
<input checked="" type="checkbox"/> Support SCP	<input checked="" type="checkbox"/> Support VOOC
<input checked="" type="checkbox"/> Support PPS	<input checked="" type="checkbox"/> Support Oneplus

3.6 * Output ripple

5V output voltage ripple 5V	250mV (Max)	At 20 MHz, and output parallel with 0.1uF & 47uF capacitors to ground Temperature at 25°C, and 115VAC input voltage
12V output voltage ripple 12V	200mV (Max)	
15V output voltage ripple 15V	200mV (Max)	
20V output voltage ripple 20V	200mV (Max)	

4. Environment Requirements

4.1. Operating Temperature and Relative Humidity :

0°C to +35°C
10%RH to 90%RH

4.2. Storage Temperature and Relative Humidity :

-20°C to +80°C
5%RH to 95%RH non-condensing @ Sea level shall be low 2,000 mete

4.3. Vibration :

10 to 300Hz sweep at a constant acceleration of 1.0G(Breadth: 3.5mm) for 1Hour for each of the perpendicular axes X, Y, Z

4.4. *Drop in :

At the most dis-advantageous angle, the fall height is 100cm, drop it to the hardwood board 3 times, the pin might be bent and the shell might be injured, but the appearance can not be structurally damaged and it should be working normally.

PROJECTION	RDII Research Develop Innovate				
	RDI, Inc. 333 North Bedford Road, Suite 135, Mount Kisco, NY 10549				
SCALE N/A	TITLE Interchangeable 65W GaN USB charger, RoHS Compliant				
TOLERANCE EXCEPT AS NOTED	DR. Tina	DATE 03/20/23	REF. P/N: MK-PG651EXC2A-NL	SHEET 4 OF 6	REV. _
DEC. MILLIMETERS 0.00±0.25mm 0.0±0.40mm 0±1.00mm	CK. BM	PRE- PS	DRAWING NO. 5353	SIZE F	REV. _
THIS DOCUMENT IS OWNED BY, AND THE INFORMATION CONTAINED IN IT IS PROPRIETARY TO, RDI, BY RECEIPT HEREOF THE HOLDER AGREES NOT TO USE THE INFORMATION AND NOT TO DISCLOSE IT TO ANY THIRD PARTY, NOR REPRODUCE THIS DOCUMENT WITHOUT THE WRITTEN CONSENT OF RDI, AND AGREES TO RETURN THIS DOCUMENT FORTHWITH UPON REQUEST.					

ECN#	DATE	SYM	REVISION RECORD	AUTH	BY	ANG.
						N/A

SPECIFICATION FOR APPROVAL

5. RELIABILITY REQUIREMENTS

5.1. * Burn-in

The product must undergo 100% burning-in before shipment to ensure the quality.

5.2. MTBF

The MTBF shall be at least 30,000 hours at 25 °C max and normal input condition

6. EMI/EMS STANDARDS

6.1. EMI Standards/EMI

Certificate	Country/国家	Standard/标准
<input checked="" type="checkbox"/> FCC	USA/美国	<input checked="" type="checkbox"/> FCC PART 15B
<input checked="" type="checkbox"/> CE	Europe/欧洲	<input checked="" type="checkbox"/> EN55032 EN55024 EN61000-3-2 EN61000-3-3
<input checked="" type="checkbox"/> C-Tick	Australia/澳洲	<input checked="" type="checkbox"/> AS/NZS CISPR22
<input type="checkbox"/> KCC	Korea/韩国	<input type="checkbox"/> K32/K35
<input type="checkbox"/> PSE	Japan/日本	<input type="checkbox"/> J55032
<input type="checkbox"/> CCC	China/中国	<input type="checkbox"/> GB17625.1 <input type="checkbox"/> GB9254

6.2. EMS Standards/EMS

6-2-1 EN 61000-4-2,electrostatic discharge(ESD) requirement

Discharge characteristic/静电规格	Test level/测试条件	Test criteria/测试标准
Air discharge/空气放电	+/-8KV	B
Contact discharge/接触放电	+/-4KV	B

6-2-2 EN 61000-4-3, radiated electromagnetic field susceptibility(rs)

Test level/测试条件	Test criteria/测试标准
3V/m (r.m.s)	A
80-1000MHz,80%AM(1KHz) sine-wave	

6-2-3 EN 61000-4-4,electric fast transients(burst) immunity requirement

Coupling/测试端口	Test level/测试条件	Test criteria/测试标准
AC-input/交流输入	0.5KV	A
AC-input/交流输入	1KV	B

6-2-4 EN 61000-4-5,surge capability requirement

Surge voltage/雷击电压 Common mode/共模 +/-2KV Differential mode/差模 +/-1KV	Test criteria/测试标准
	A

6-2-5 EN 61000-4-6, Induced radio frequency fields conducted disturbances immunity requirement/

Test level/测试条件	Test criteria/测试标准
3V	A
0.15-80 MHz,80%AM(1KHz)	

6-2-6 Assessment criteria

Acceptance criteria	Performance
A	Agreed operational behavior within the specified limits
B	Time limited functional diminishment or malfunction during the tests is permitted. The function is self-reactivated by the unit following completion of the tests.
C	Malfunction is permitted .The function can be reactivated either by reconnection to the mains or by operator intervention.

7. SAFETY STANDARDS

7.1. * Dielectric Strength(Hi-pot)

Primary to Secondary: 3000Vac / 5mAMax / 60 second

7.2. Leakage Current

0.25mAmax. at 264Vac / 50Hz

7.3. Insulation Resistance

50MΩ min. at primary to secondary add 500Vdc test voltage

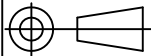
PROJECTION				Research Develop Innovate	
		RDI, Inc. 333 North Bedford Road, Suite 135, Mount Kisco, NY 10549			
SCALE	N/A	TITLE Interchangeable 65W GaN USB charger, RoHS Compliant			
TOLERANCE EXCEPT AS NOTED	DR. Tina	DATE 03/20/23	REF. P/N: MK-PG651EXC2A-NL	SHEET 5 OF 6	
DEC. MILLIMETERS 0.00±0.25mm 0.0±0.40mm 0±1.00mm	CK. BM	PRE- PS	DRAWING NO. 5353	SIZE F	REV. _
THIS DOCUMENT IS OWNED BY, AND THE INFORMATION CONTAINED IN IT IS PROPRIETARY TO, RDI, BY RECEIPT HEREOF THE HOLDER AGREES NOT TO USE THE INFORMATION AND NOT TO DISCLOSE IT TO ANY THIRD PARTY, NOR REPRODUCE THIS DOCUMENT WITHOUT THE WRITTEN CONSENT OF RDI, AND AGREES TO RETURN THIS DOCUMENT FORTHWITH UPON REQUEST.					

ECN#	DATE	SYM	REVISION RECORD	AUTH	BY

ANG.	N/A

SPECIFICATION FOR APPROVAL

7.4. REGULATORY STANDARDS

Certificate	Countr	Standard
<input checked="" type="checkbox"/> UL / cUL	USA / 美國	<input checked="" type="checkbox"/> UL62368-1 <input type="checkbox"/> UL60950-1 <input type="checkbox"/> UL60065 <input type="checkbox"/> UL1310
<input type="checkbox"/> ETL	USA / 美國	<input type="checkbox"/> UL62368-1 <input type="checkbox"/> UL60950-1 <input type="checkbox"/> UL60065 <input type="checkbox"/> UL1310
<input type="checkbox"/> GS	Germany / 德國	<input type="checkbox"/> EN62368-1 <input type="checkbox"/> EN60950-1 <input type="checkbox"/> EN60065
<input checked="" type="checkbox"/> CE	Europe / 歐洲	<input checked="" type="checkbox"/> EN62368-1 <input type="checkbox"/> EN60950-1 <input type="checkbox"/> EN60065
<input checked="" type="checkbox"/> SAA	Australia / 澳洲	<input checked="" type="checkbox"/> AS/NZS62368-1 <input type="checkbox"/> AS/NZS60950-1 <input type="checkbox"/> AS/NZS60065
<input type="checkbox"/> PSE	Japan / 日本	<input type="checkbox"/> J62368-1 <input type="checkbox"/> J60950-1 <input type="checkbox"/> J60065
<input type="checkbox"/> S-Mark	Argentina / 阿根廷	<input type="checkbox"/> IEC62368-1 <input type="checkbox"/> IEC60950-1 <input type="checkbox"/> EC60065
<input type="checkbox"/> CCC	China / 中国	<input type="checkbox"/> GB4943 <input type="checkbox"/> GB8898 <input type="checkbox"/> GB4706.1
<input type="checkbox"/> KC	Korea / 韩国	<input type="checkbox"/> K60950-1
<input type="checkbox"/> BSMI	Taiwan / 台湾	<input type="checkbox"/> CNS13438 & 14336-1
<input type="checkbox"/> PSB	Singapore / 新加坡	<input type="checkbox"/> IEC62368-1 <input type="checkbox"/> IEC60950-1 <input type="checkbox"/> EC60065
<input checked="" type="checkbox"/> CB	IECEE / 国际电工委员会	<input checked="" type="checkbox"/> IEC62368-1 <input type="checkbox"/> IEC60950-1 <input type="checkbox"/> EC60065

RATING LABEL :

To be confirmed

RATING LABEL :

Unit : mm Tolerance : +0/-0.2mm



65W GaN Quick Charger
Model:MK-PG651EXC2A

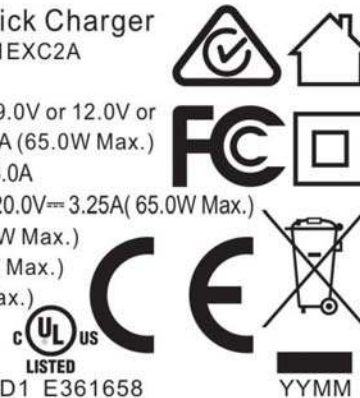

Input:100-240V~50/60Hz,1.5A Max.
USB-C1/C2 Output:3.3V-11.0V==3.0A,5.0V or 9.0V or 12.0V or 15.0V==3.0A,20.0V==3.25A (65.0W Max.)
USB-A Output:5.0V==3.0A or 4.5A, 9.0V==2.2A or 3.0A 12.0V==1.5A or 3.0A 15.0V==3.0A, 20.0V==3.25A(65.0W Max.)
USB-C1+USB-C2 Output:45.0W+18.0W (63.0W Max.)
USB-C1+USB-A Output:45.0W+18.0W (63.0W Max.)
USB-C2+USB-A Output:5.0V==3.0A (15.0W Max.)
USB-C1+USB-C2+USB-A Total Output: 45.0W+15.0W/5.0V==3.0A(60.0W Max.)

Made in China QQJQ POWER SUPPLY 5BD1 E361658

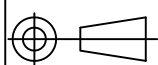

NOTE :

1. White ground on black text.
2. Laser printing, wipe resistance
3. Compliance to RoHS.
4. YYMM means Date Code
YY means Year (like 20)
MM means Month(like 01-12)

PROJECTION		  Research Develop Innovate RDI, Inc. 333 North Bedford Road, Suite 135, Mount Kisco, NY 10549			
SCALE	N/A	TITLE Interchangeable 65W GaN USB charger, RoHS Compliant			
TOLERANCE EXCEPT AS NOTED	DR. Tina	DATE 03/20/23	REF. P/N: MK-PG651EXC2A-NL	SHEET 6 OF 6	
DEC. MILLIMETERS 0.00±0.25mm 0.0±0.40mm 0±1.00mm	CK. BM	PRE-PS	DRAWING NO. 5353	SIZE F	REV. _
THIS DOCUMENT IS OWNED BY, AND THE INFORMATION CONTAINED IN IT IS PROPRIETARY TO, RDI, BY RECEIPT HEREOF THE HOLDER AGREES NOT TO USE THE INFORMATION AND NOT TO DISCLOSE IT TO ANY THIRD PARTY, NOR REPRODUCE THIS DOCUMENT WITHOUT THE WRITTEN CONSENT OF RDI, AND AGREES TO RETURN THIS DOCUMENT FORTHWITH UPON REQUEST.					

ECN#	DATE	SYM	REVISION RECORD	AUTH	BY
------	------	-----	-----------------	------	----