

# Triple-Channel Video Reconstruction Filter and Buffer for Composite and Y/C Outputs

## General Description

The MAX7453 is a low-cost, triple-channel video reconstruction filter for S-video and CVBS video-signal applications. This device is ideal for anti-aliasing and DAC smoothing video applications such as set-top boxes, DVD players, hard-disk recorders (HDRs), and personal video recorders. This filter operates from a single +5V supply. It is optimized for NTSC, PAL, and standard-definition TV (SDTV) video systems.

Each channel consists of a lowpass filter and an output buffer capable of driving one (YOUT, COUT) or two (CVOUT) standard 150Ω video loads. The output buffers can drive either an AC or a DC load such that the blanking level voltage after the backmatch resistor is less than 1V. The Y and C video inputs are summed to produce the composite video output. The MAX7453 has a maximally flat frequency response.

The MAX7453 is available in an 8-pin SO package and is fully specified over the commercial (0°C to +70°C) temperature range.

## Applications

Set-Top Boxes/HDRs/DVDs  
Security Cameras/Digital Cameras  
Game Consoles  
Digital VCRs  
Every Composite, S-Video Output for NTSC, PAL, and SDTV

## Features

- ◆ Triple-Channel Filter and Buffer for CVBS and Y/C (S-Video) Video Signals
- ◆ Filter Response Ideal for NTSC, PAL, and Interlaced SDTV Signals
- ◆ 42dB (typ) Stopband Attenuation at 27MHz
- ◆ -0.3dB (typ) Passband Response
- ◆ <1V Blanking Level Allows DC-Coupled Output
- ◆ CVOUT Drives Two 150Ω Video Loads
- ◆ YOUT and COUT Drive One 150Ω Video Load
- ◆ +5V Single-Supply Voltage
- ◆ 8-Pin SO Package

## Ordering Information

PART	TEMP RANGE	PIN-PACKAGE
MAX7453CSA	0°C to +70°C	8 SO

## Pin Configuration

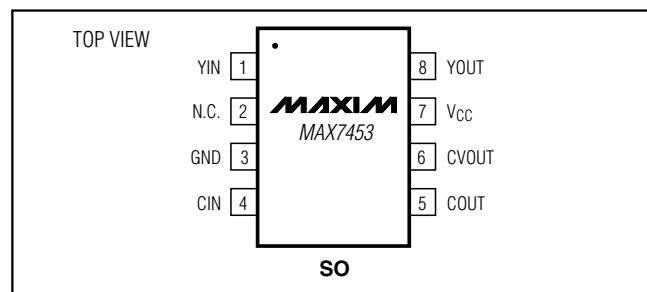

## Functional Diagram

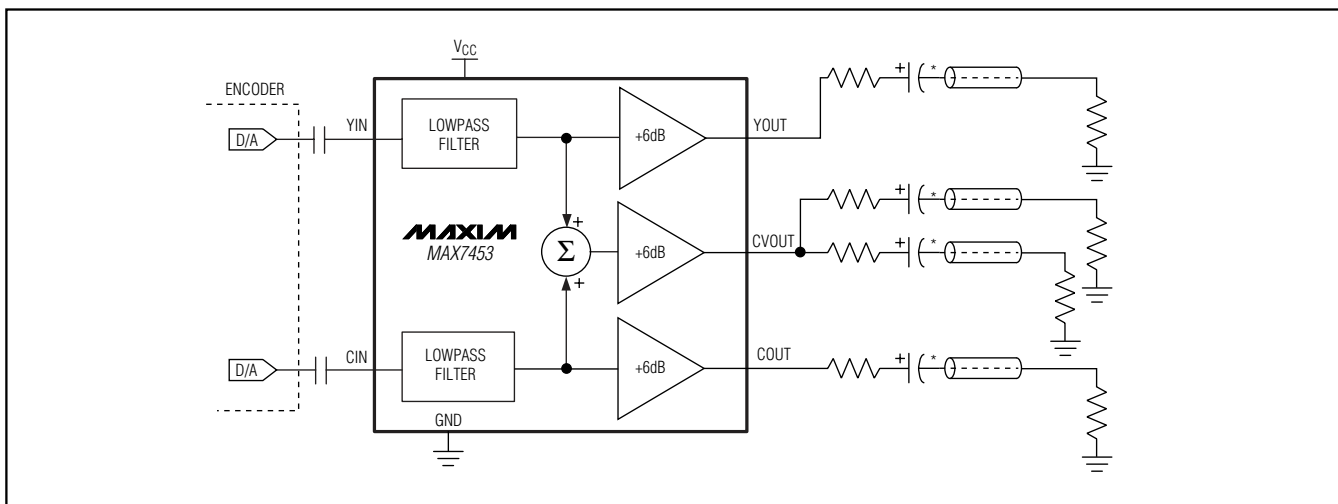

# Triple-Channel Video Reconstruction Filter and Buffer for Composite and Y/C Outputs

## ABSOLUTE MAXIMUM RATINGS

V<sub>CC</sub> to GND .....+6V  
 All Other Pins to GND .....-0.3V to (V<sub>CC</sub> + 0.3V)  
 Maximum Current into Any Pin Except V<sub>CC</sub> and GND .....±50mA  
 Continuous Power Dissipation (T<sub>A</sub> = +70°C)  
 8-Pin SO .....522.8mW

Operating Temperature Range .....0°C to +70°C  
 Storage Temperature Range .....-65°C to +150°C  
 Junction Temperature .....+150°C  
 Lead Temperature (soldering, 10s) .....+300°C

*Stresses beyond those listed under "Absolute Maximum Ratings" may cause permanent damage to the device. These are stress ratings only, and functional operation of the device at these or any other conditions beyond those indicated in the operational sections of the specifications is not implied. Exposure to absolute maximum rating conditions for extended periods may affect device reliability.*

## ELECTRICAL CHARACTERISTICS

(V<sub>CC</sub> = +5V ±5%, C<sub>L</sub> = 0 to 20pF, all loads to GND for DC-couple, all loads to V<sub>CC</sub> / 2 for AC-couple, C<sub>YIN</sub> = C<sub>CIN</sub> = 0.1μF, R<sub>YOUT</sub> = 150Ω, R<sub>COU</sub>T = 150Ω, R<sub>CVOUT</sub> = 75Ω, T<sub>A</sub> = T<sub>MIN</sub> to T<sub>MAX</sub>, unless otherwise noted. Typical values are at T<sub>A</sub> = +25°C.)

PARAMETER	SYMBOL	CONDITIONS	MIN	TYP	MAX	UNITS
Passband Response		f = 100kHz to 4.2MHz, relative to 100kHz	-0.6	-0.27	0	dB
Stopband Attenuation	A <sub>SB</sub>	f = 27MHz	39	42		dB
Chroma/Luma Gain		f = 3.58MHz, reference to CVOUT at 336kHz	96	98	100	%
Differential Gain	dG	5-step modulated staircase		0.15	0.5	%
Differential Phase	dθ	5-step modulated staircase		0.15	0.5	Degrees
Signal-to-Noise Ratio	SNR	Peak signal (2V <sub>p-p</sub> ) to RMS noise, f = 100Hz to 50MHz	67	73		dB
Line-Time Distortion	H <sub>DIST</sub>	18μs, 100IRE bar			0.3	%
Field-Time Distortion	V <sub>DIST</sub>	130 lines, 18μs, 100IRE bar			0.5	%
Clamp Settling Time		To ±1%		300		Lines
Output DC Clamp Level		YOUT	0.60	0.8	0.95	V
		CVOUT	0.60	0.8	0.95	
		COUT	1.44	1.6	1.95	
Low-Frequency Gain Accuracy	A <sub>V</sub>	f = 100kHz, relative to 6dB	-3.0		+2.0	%
Group-Delay Deviation	Δt <sub>g</sub>	Deviation from 100kHz to 4.1MHz		8	16	ns
Group-Delay Matching	t <sub>g</sub> (MATCH)	Low-frequency channel-to-channel matching, f = 100kHz for YOUT and COUT		2		ns
Channel-to-Channel Crosstalk	X <sub>TALK</sub>	f = 100kHz to 3.58MHz		61		dB
Input Leakage Current	I <sub>IN</sub>				10	μA
Input Dynamic Swing	Y <sub>INP-P</sub>				1.2	V <sub>p-p</sub>
	C <sub>INP-P</sub>				0.9	
<b>SUPPLY</b>						
Supply Voltage Range	V <sub>CC</sub>		4.75		5.25	V
Supply Current	I <sub>CC</sub>	V <sub>CC</sub> = +5.25V, no load		65	85	mA
Power-Supply Rejection Ratio	PSRR	V <sub>IN</sub> = 100mV <sub>p-p</sub> , f = 0 to 3.5MHz		33		dB

# Triple-Channel Video Reconstruction Filter and Buffer for Composite and Y/C Outputs

## Typical Operating Characteristics

(V<sub>CC</sub> = +5V, T<sub>A</sub> = +25°C, unless otherwise noted.)

MAX7453

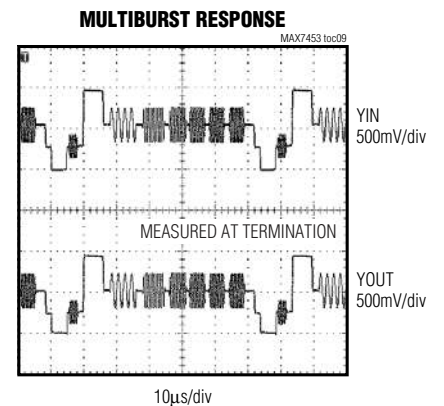
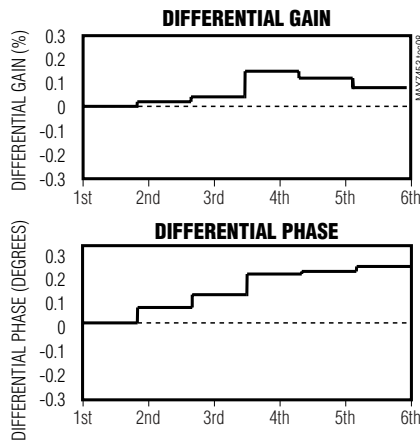
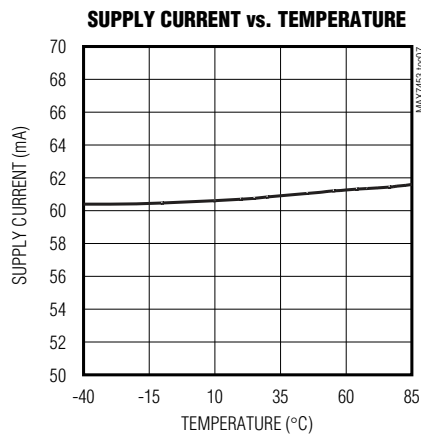
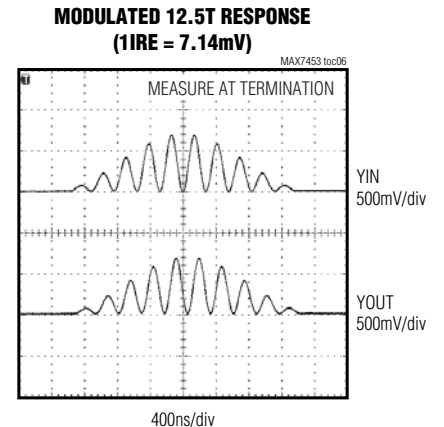
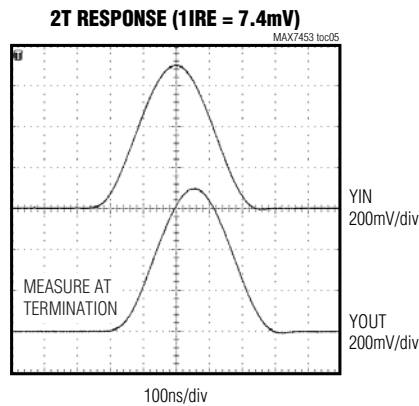
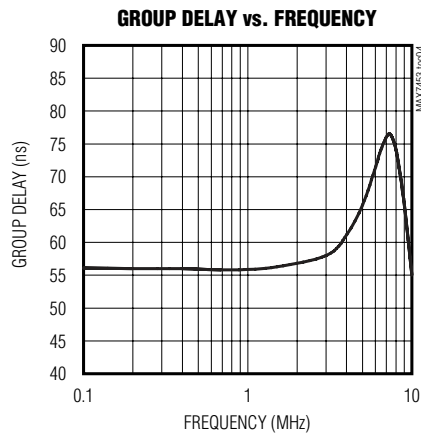
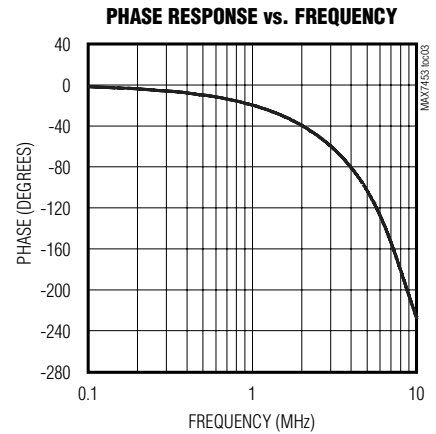
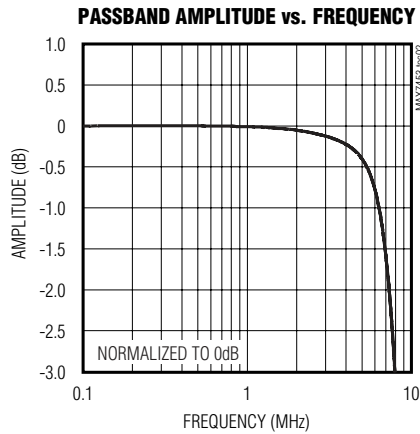
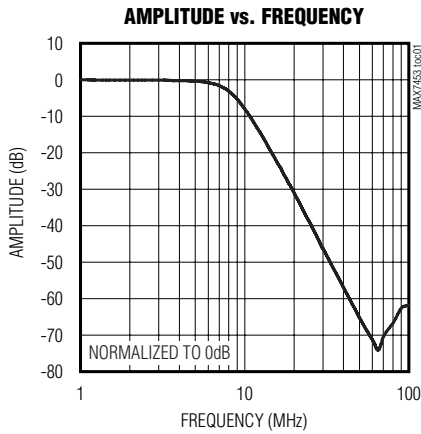

# Triple-Channel Video Reconstruction Filter and Buffer for Composite and Y/C Outputs

## Pin Description

PIN	NAME	FUNCTION
1	YIN	Luma (Y) Input
2	N.C.	No Connection. No internal connection.
3	GND	Ground
4	CIN	Chroma (C) Input
5	COUT	Chroma (C) Output
6	CVOUT	Composite Video Output
7	VCC	5V Power Supply
8	YOUT	Luma (Y) Output

## Detailed Description

The primary function of the MAX7453 is to filter and buffer the encoder DAC outputs that contain digital video information in applications such as set-top boxes, HDRs, DVD players, and digital VCRs. This device reconstructs and cleans up analog video signals. The MAX7453 consists of a lowpass filter and a +6dB-gain output video buffer. The luma (YIN) and chroma (CIN) video inputs are summed internally to provide the composite (CVOUT) video output.

These devices operate from a single +5V supply. The filters have a nominal cutoff frequency optimized for NTSC, PAL, and SDTV.

### Filter

#### Filter Response

The reconstruction filter consists of two 2nd-order Sallen-Key stages. The Butterworth-type response features a maximally flat passband for NTSC and PAL bandwidths. The stopband offers 42dB (typ) of attenuation at sampling frequencies of 27MHz and above (see the *Typical Operating Characteristics*).

#### Output Buffer

The YOUT and COUT buffers have a fixed +6dB gain capable of driving one standard 150Ω video load with a 2V<sub>p-p</sub> signal. The CVOUT buffer has a fixed +6dB gain, capable of driving two 150Ω video loads. The MAX7453 can drive an AC load or drive the video load directly without using the large output capacitor. The output buffer of all the channels drives a DC load with an output blanking level of less than 1V.

### Output Clamp Level

When sync pulses in the luma signal (Y) are detected, the DC restore loop is activated. The function of the loop is to set the sync tip of the video signal to the desired DC level of 0.8V for YOUT and COUT, and to set the average DC voltage of COUT at 1.6V.

## Applications Information

### Input Considerations

Use a 0.1μF ceramic capacitor to AC-couple the input to the MAX7453. This input capacitor stores a DC level such that the outputs are clamped to the appropriate DC voltage level.

### Output Considerations

The outputs of the MAX7453 are typically connected to a 75Ω series back-match resistor followed by the video cable. Because of the inherent divide-by-two of this configuration, the blanking level of the video cable is always less than 1V, which complies with industry-standard video requirements. The video buffer can also drive an AC-coupled video load. Good video performance is achieved with an output capacitor as low as 220μF.

### Power-Supply Bypassing and Layout

The MAX7453 operates from a single +5V supply. Bypass VCC to GND with a 0.1μF capacitor. Place all external components as close to the device as possible. The maximum power dissipation listed in the *Absolute Maximum Ratings* section assumes that the PC board is a multilayer board with ground and power planes.

## Chip Information

TRANSISTOR COUNT: 4100

PROCESS: BiCMOS

# Triple-Channel Video Reconstruction Filter and Buffer for Composite and Y/C Outputs

## Package Information

(The package drawing(s) in this data sheet may not reflect the most current specifications. For the latest package outline information, go to [www.maxim-ic.com/packages](http://www.maxim-ic.com/packages).)

MAX7453

SOICN EPSS

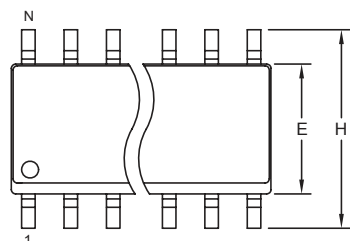

TOP VIEW

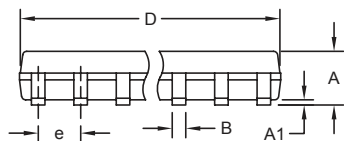

FRONT VIEW

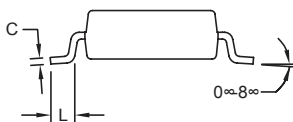

SIDE VIEW

DIM	INCHES		MILLIMETERS	
	MIN	MAX	MIN	MAX
A	0.053	0.069	1.35	1.75
A1	0.004	0.010	0.10	0.25
B	0.014	0.019	0.35	0.49
C	0.007	0.010	0.19	0.25
e	0.050 BSC		1.27 BSC	
E	0.150	0.157	3.80	4.00
H	0.228	0.244	5.80	6.20
L	0.016	0.050	0.40	1.27

VARIATIONS:

DIM	INCHES		MILLIMETERS		N	MS012
	MIN	MAX	MIN	MAX		
D	0.189	0.197	4.80	5.00	8	AA
D	0.337	0.344	8.55	8.75	14	AB
D	0.386	0.394	9.80	10.00	16	AC

NOTES:

1. D&E DO NOT INCLUDE MOLD FLASH.
2. MOLD FLASH OR PROTRUSIONS NOT TO EXCEED 0.15mm (.006").
3. LEADS TO BE COPLANAR WITHIN 0.10mm (.004").
4. CONTROLLING DIMENSION: MILLIMETERS.
5. MEETS JEDEC MS012.
6. N = NUMBER OF PINS.

<small>PROPRIETARY INFORMATION</small>	
<small>TITLE:</small> PACKAGE OUTLINE, .150" SOIC	
<small>APPROVAL</small>	<small>DOCUMENT CONTROL NO.</small> 21-0041
<small>REV.</small> B	<small>REV.</small> 1/1

Maxim cannot assume responsibility for use of any circuitry other than circuitry entirely embodied in a Maxim product. No circuit patent licenses are implied. Maxim reserves the right to change the circuitry and specifications without notice at any time.

Maxim Integrated Products, 120 San Gabriel Drive, Sunnyvale, CA 94086 408-737-7600 \_\_\_\_\_ 5