

Ultra-compact EMC/RFI Filter for Motor Drives Applications

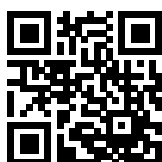

- New: solid safety connector blocks available for the whole range
- Exceptional attenuation performance from 150 kHz to 30 MHz
- Excellent saturation resistance up to 50 m cable length
- Most compact and slim filter design in its class



Performance indicators

Attenuation performance



Rated current [A]

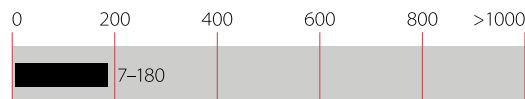

Technical Specifications

Maximum continuous operating voltage	3x 520/300 VAC (FN 3258 H) 3x 480/277 VAC (FN 3258)
Operating frequency	DC to 60 Hz
Rated currents	7 to 180 A
High potential test voltage	P → E 2650 / 2750 VDC for 2 sec (FN 3258 / FN 3258H) P → P 2100 / 2250 VDC for 2 sec (FN 3258 / FN 3258H)
Protection category	IP 20
Overload capability	4x rated current at switch on, 1.5x rated current for 1 minute, once per hour
Temperature range (operation and storage)	-25°C to +100°C (25/100/21)
Flammability corresponding to	UL 94 V-2 or better
Design corresponding to	UL 1283, CSA 22.2 No. 8 1986, IEC/EN 60939
MTBF @ 50°C/400 V (Mil-HB-217F)	300,000 hours

Approvals & Compliances



Features and Benefits

- The extremely compact and slim filter design allows a trouble-free installation even where the available mounting space is minimal
- With new additional filter types providing safety terminal blocks, the most preferred connection style can be chosen fast and easy. This helps to stay in line with the electrical connection concept of a given application
- FN 3258 filters ensure compliance with Class A limits according to EN 55011 up to 50 m cable length and beyond. Further they can contribute significantly to meet conducted emission limits according to Class B
- Filter operation on the mains input side of consumers increases their reliability and conducted immunity significant
- Chokes with exceptional saturation resistance and excellent thermal behavior are a vital part of FN 3258 design. Thus, all filters retain the expected filter performance even in very noisy applications and under full load conditions



Typical Applications

- Three-phase variable speed motor drives, servo drives, inverters and converters
- Applications comprising energy conversion devices like machines or process automation equipment
- HVAC equipment, elevators, power supplies, UPS and further three-phase applications

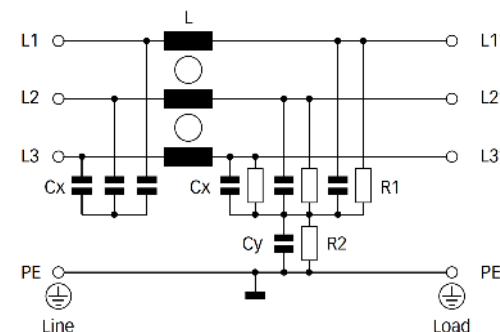
Typical electrical schematic



Filter Selection Table

Filter	Buy	Rated current @ 50°C (40°C)	Typical drive Power Rating*	Leakage current** @ 480/520 VAC/50 Hz	Power loss @ 25°C/50 Hz	Input/Output Connections	Weight
		[A]	[kW]	[mA]	[W]		[kg]
FN3258-7-44		7 (7.7)	4	4.3	3.8	-44	0.5
FN3258-16-44		16 (17.5)	7.5	4.3	6.1	-44	0.8
FN3258-30-33		30 (32.9)	15	4.3	11.8	-33	1.2
FN3258-42-33		42 (46.0)	22	4.3	15.7	-33	1.4
FN3258-55-34		55 (60.2)	30	4.3	25.9	-34	2.0
FN3258-75-34		75 (82.2)	37	4.3	32.2	-34	2.7
FN3258-100-35		100 (109.5)	55	4.3	34.5	-35	4.3
FN3258-130-35		130 (142.4)	75	4.3	43.1	-35	4.5
FN3258-180-40		180 (197.1)	90	4.3	58.3	-40	6.0
FN3258H-7-44		7 (7.7)	4	4.7	3.8	-44	0.5
FN3258H-16-44		16 (17.5)	7.5	4.7	6.1	-44	0.8
FN3258H-30-33		30 (32.9)	18.5	4.7	11.8	-33	1.2
FN3258H-42-33		42 (46.0)	22	4.7	15.7	-33	1.4
FN3258H-55-34		55 (60.2)	37	4.7	25.9	-34	2.0
FN3258H-75-34		75 (82.2)	45	4.7	32.2	-34	2.7
FN3258H-100-35		100 (109.5)	55	4.7	34.5	-35	4.3
FN3258H-130-35		130 (142.4)	75	4.7	43.1	-35	4.5
FN3258H-180-40		180 (197.1)	110	4.7	58.3	-40	6.0

* Calculated at rated current, 440 VAC (FN3258)/480 VAC (FN3258H) and cos phi=0.8. The exact value depends upon the efficiency of the drive, the motor and the entire application.

** Standardized calculated leakage current acc. IEC60939 under normal operating conditions (FN3258 at 480 VAC and FN3258H at 520 VAC).

Thermal Derating

If higher ambient temperatures than the specified apply, the nominal current needs to be reduced according to the graph below.

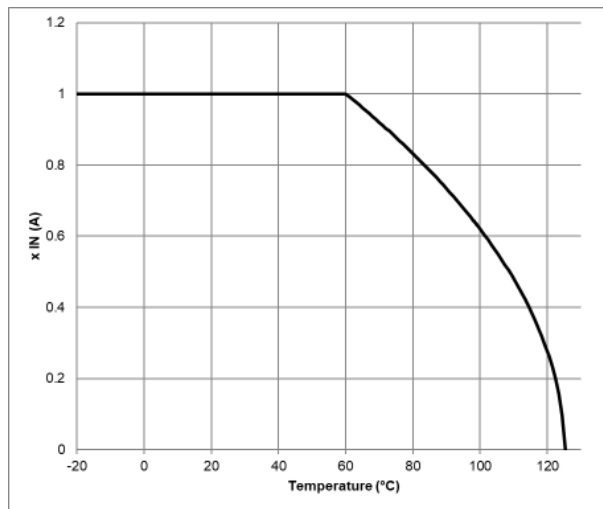

Typical Filter Attenuation

Per CISPR 17; DM=50/50 sym; CM=50/50 asym

7 A type

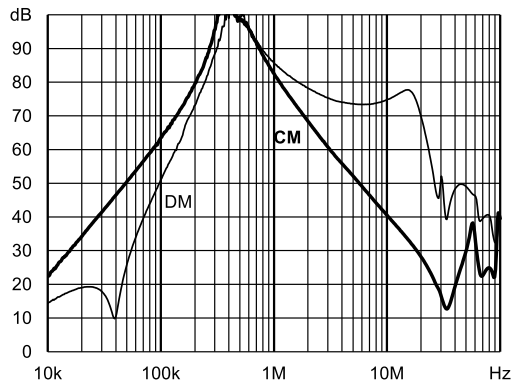

16 A type

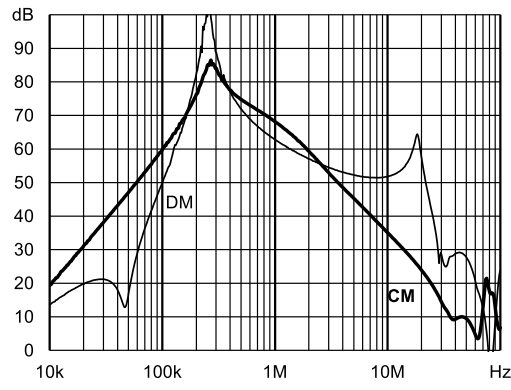

30 A type

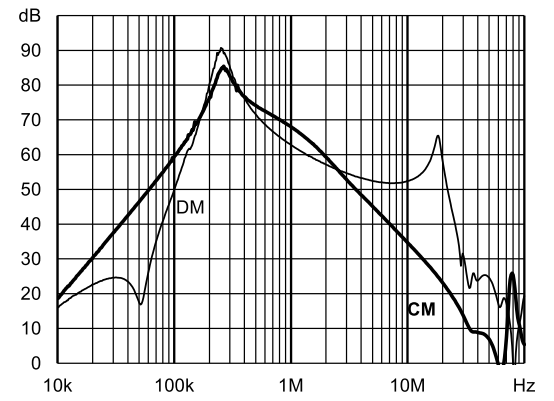

42 A type

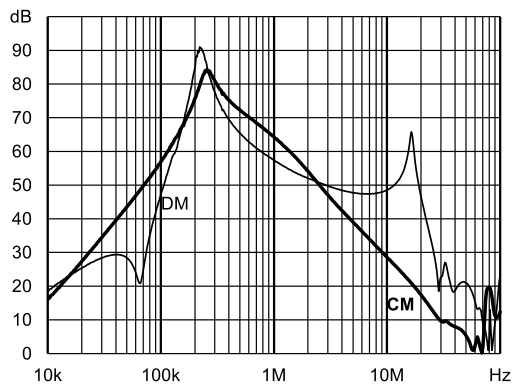

55 A type

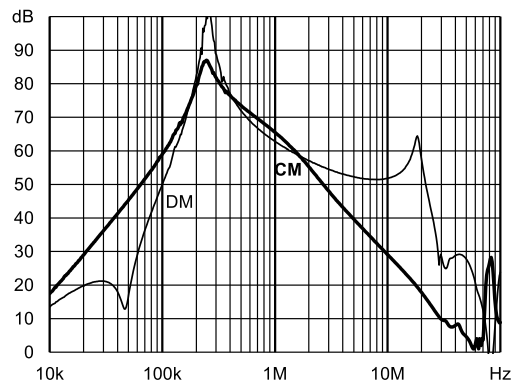

75 A type

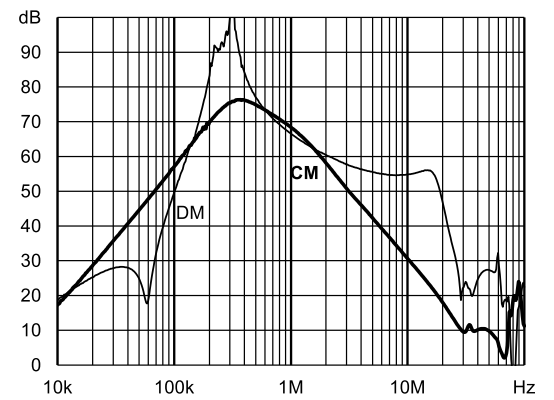

100 A type

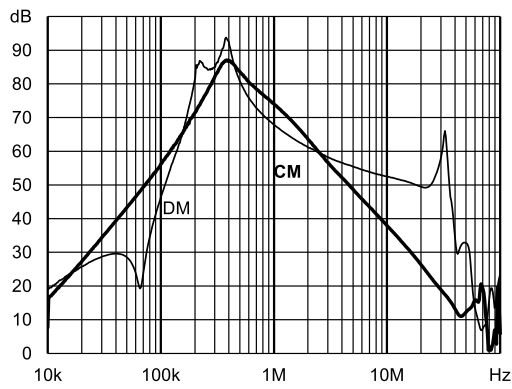

130 A type

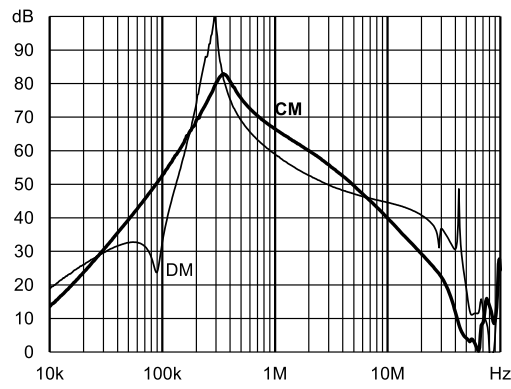

180 A type

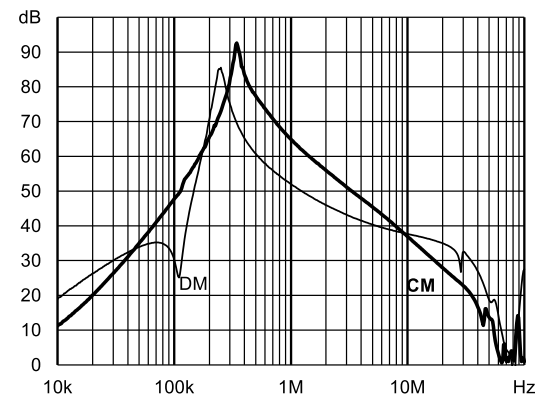

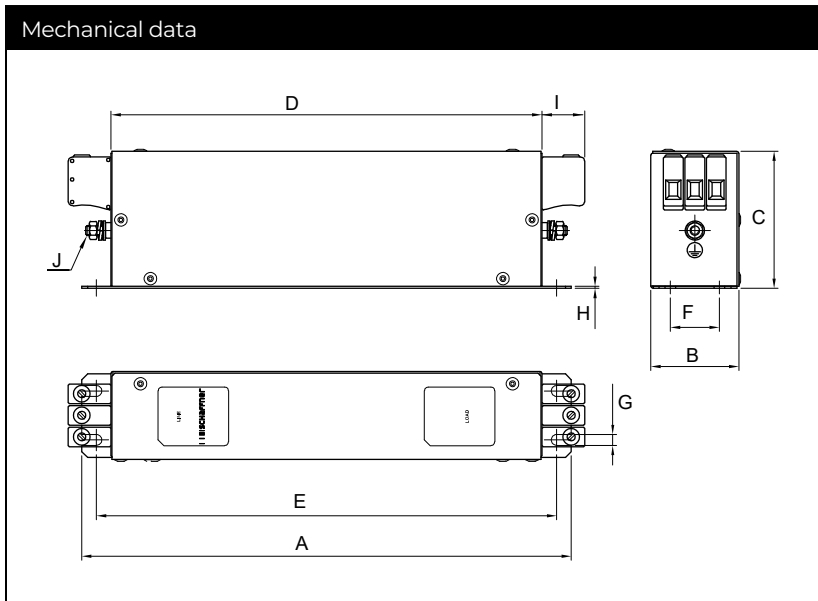

Note: in favour of a better readability, connectors and earth studs are not shown in the horizontal projection.

Dimensions

	7 A	16 A	30 A	42 A	55 A	75 A	100 A	130 A	180 A
A	190	250	270	310	250	270	270	270	380
B	40	45	50	50	85	80	90	90	120
C	70	70	85	85	90	135	150	150	170
D	160	220	240	280	220	240	240	240	350
E	180	235	255	295	235	255	255	255	365
F	20	25	30	30	60	60	65	65	102
G	4.5	5.4	5.4	5.4	5.4	6.5	6.5	6.5	6.5
H	1	1	1	1	1	1.5	1.5	1.5	1.5
I	22	22	25	25	39	39	45	45	51
J	M5	M5	M5	M6	M6	M6	M10	M10	M10
K	20	22.5	25	25	42.5	40	45	45	60
L2	29.5	29.5	39.5	37.5	26.5	70.5	64	64	47

All dimensions in mm; 1 inch = 25.4 mm

Tolerances according: ISO 2768-m/EN 22768-m

Filter Input/Output Connector Cross Sections

	-33	-34	-35	-40	-44
Solid wire	16 mm ²	35 mm ²	50 mm ²	95 mm ²	10 mm ²
Flex wire	10 mm ²	25 mm ²	50 mm ²	95 mm ²	6 mm ²
AWG type wire	AWG 6	AWG 2	AWG 1/0	AWG 4/0	AWG 8
Recommended torque	1.5-1.8 Nm	4.0-4.5 Nm	7-8 Nm	17-20 Nm	1.0-1.2 Nm

Please visit www.schaffner.com to find more details on filter connectors.

Headquarters, Global Innovation and Development

Switzerland

Schaffner Holding AG

Industrie Nord
 Nordstrasse 11e
 4542
 Luterbach
 +41 32 681 66 26
info@schaffner.com

Sales and Application Centers

China

Schaffner EMC Ltd. Shanghai

T20-3 C, No 565 Chuangye Road, Pudong district
 201201
 Shanghai
 +86 2138139500
cschina@schaffner.com

Finland

Schaffner Oy

Sauvonrinne 19 H
 8500
 Lohja
 +358 50 468 7284
finlandsales@schaffner.com

France

Schaffner EMC S.A.S.

16-20 Rue Louis Rameau
 95875
 Bezons
 +33 1 34 34 30 60
francesales@schaffner.com

Germany

Schaffner Deutschland GmbH

Schoemperlenstrasse 12B
 76185
 Karlsruhe
 +49 721 56910
germanysales@schaffner.com

India

Schaffner India Pvt. Ltd

Regus World Trade Centre
 WTC, 22nd Floor Unit No 2238, Brigade Gateway Campus, 26/1, Dr. Rajkumar Road Malleshwaram (W)
 560055
 Bangalore
 +91 8067935355
indiasales@schaffner.com

Italy

Schaffner EMC S.r.l.

Via Ticino, 30
 20900
 Monza (MB)
 +39 039 21 41 070
italysales@schaffner.com

Japan

Schaffner EMC K.K.

ISM Sangenjaya 7F
 1-32-12 Kamiuma, Setagaya-ku
 154-0011
 Tokyo
 +81 3 5712 3650
japansales@schaffner.com

Singapore

Schaffner EMC Pte Ltd.

Blk 3015A Ubi Road 1, #05-09, Kampong Ubi Industrial Estate
 408705
 Singapore
 +65 63773283
singaporesales@schaffner.com

Spain

Schaffner EMC España

Calle Caléndula 93, Miniparc III, Edificio E El Soto de Moraleja, Alcobendas
 28109
 Madrid
 +34 917 912 900
spainsales@schaffner.com

Sweden

Schaffner EMC AB

Östermalmstrorg 1
 114 42
 Stockholm
 +46 8 5050 2425
swedensales@schaffner.com

Switzerland

Schaffner EMV AG

Industrie Nord
 Nordstrasse 11e
 4542
 Luterbach
 +41 32 681 66 26
switzerlandsales@schaffner.com

Taiwan

Schaffner EMV Ltd.

U-Town
 20 Floor-2, No 97, Section 1, XinTai 5th Road, XiZhi District
 22175
 New Taipei City
 +886 226975500
taiwansales@schaffner.com

Thailand

Schaffner EMC Co. Ltd.

Sathorn Square Tower
 Room 3780, 37FL, 98 North-Sathorn Rd, Silom, Bangrak
 10500
 Bangkok
 +66 621056397
thailandsales@schaffner.com

United Kingdom

Schaffner Ltd.

1, Oakmede Place
 Terrace Road
 RG42 4JF
 Binfield
 +44 118 9770070
uksales@schaffner.com

United States

Schaffner EMC Inc.

52 Mayfield Avenue
 Edison, New Jersey
 +1 732 225 9533
usasales@schaffner.com

To find your local partner within Schaffner's global network schaffner.com

© 2022 Schaffner Group

The content of this document has been carefully checked and understood. However, neither Schaffner nor its subsidiaries assume any liability whatsoever for any errors or inaccuracies of this document and the consequences thereof. Published specifications are subject to change without notice. Product suitability for any area of application must ultimately be determined by the customer. In all cases, products must never be operated outside their published specifications. Schaffner does not guarantee the availability of all published products. This disclaimer shall be governed by substantive Swiss law and resulting disputes shall be settled by the courts at the place of business of Schaffner Holding AG. Latest publications and a complete disclaimer can be downloaded from the Schaffner website. All trademarks recognized.