

## General Description

The AL8843Q is a hysteresis mode DC-DC step-down converter, designed for driving single or multiple series connected LEDs efficiently from a voltage source higher than the LED voltage. The device can operate from an input supply between 4.5V and 40V and provide an externally adjustable output current up to 3A. Depending upon supply voltage and external components, this converter can provide up to 60W of output power.

The AL8843Q integrates the power switch and a high-side output current sensing circuit, which uses an external resistor to set the nominal average output current.

Dimming can be realized by applying an external control signal to the CTRL Pin. The CTRL Pin will accept either a DC voltage signal or a PWM signal.

The soft-start time can be adjusted by an external capacitor from the CTRL Pin to Ground. Applying a voltage of 0.3V or lower to the CTRL Pin will shut down the power switch.

## Applications

- Automotive Daytime Running Lights
- Automotive Front and Rear Fog Lights
- Automotive Turn/Stop Lights
- Automotive Dimmable Interior Lights

## Key Features

- Wide Input Voltage Range: 4.5V to 40V
- Output Current up to 3A
- Internal 40V NDMOS Switch
- Typical 4% Output Current Accuracy
- Single Pin for On/Off and Brightness Control by DC Voltage or PWM Signal
- Recommended Analog Dimming Range: 10% to 100%
- Soft-Start
- High Efficiency (Up to 97%)
- LED Short Protection
- Inherent Open-Circuit LED Protection
- Over Temperature Protection (OTP)
- Up to 1MHz Switching Frequency
- SO-8EP Packages Available in Green Molding Compound (No Br, Sb)

## AL8843QEV1 Specifications

Parameter	Value
Input Voltage	5VDC to 40VDC
LED Current	2A
Number of LEDs	1~10 LEDs
XYZ Dimension	63mm x 40mm x 10mm

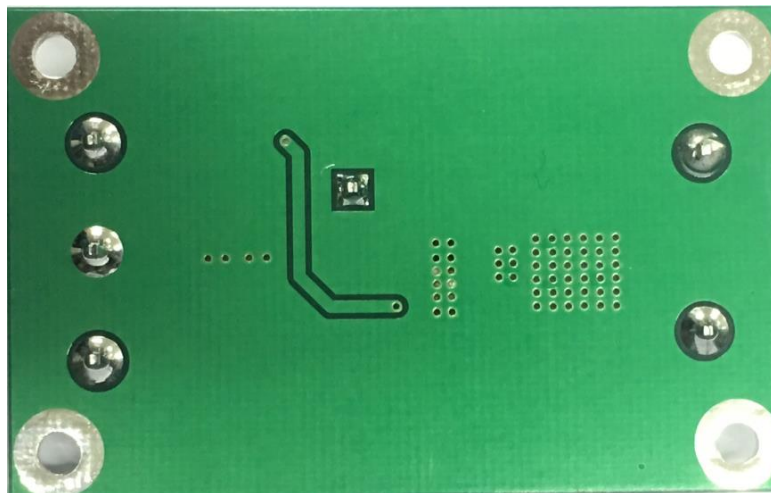
**Figure 1: Top View****Figure 2: Bottom View**

### Connection Instructions

Power Supply Input: 5~40VDC (VIN, GND)

CTRL: Internal voltage ref. pin (2.5V). This pin can be used to achieve dimming and for switching the output current off. Leave floating for normal operation.

PWM Signal Input: Remove C4, apply PWM signal to CTRL (CTRL, GND)

Analog Signal Input: Connect 470nF capacitor to C4, apply analog signal to CTRL (CTRL, GND)

LED A: LED A connects to the external LED anode

LED K: LED K connects to the external LED cathode

**Evaluation Board Schematic**

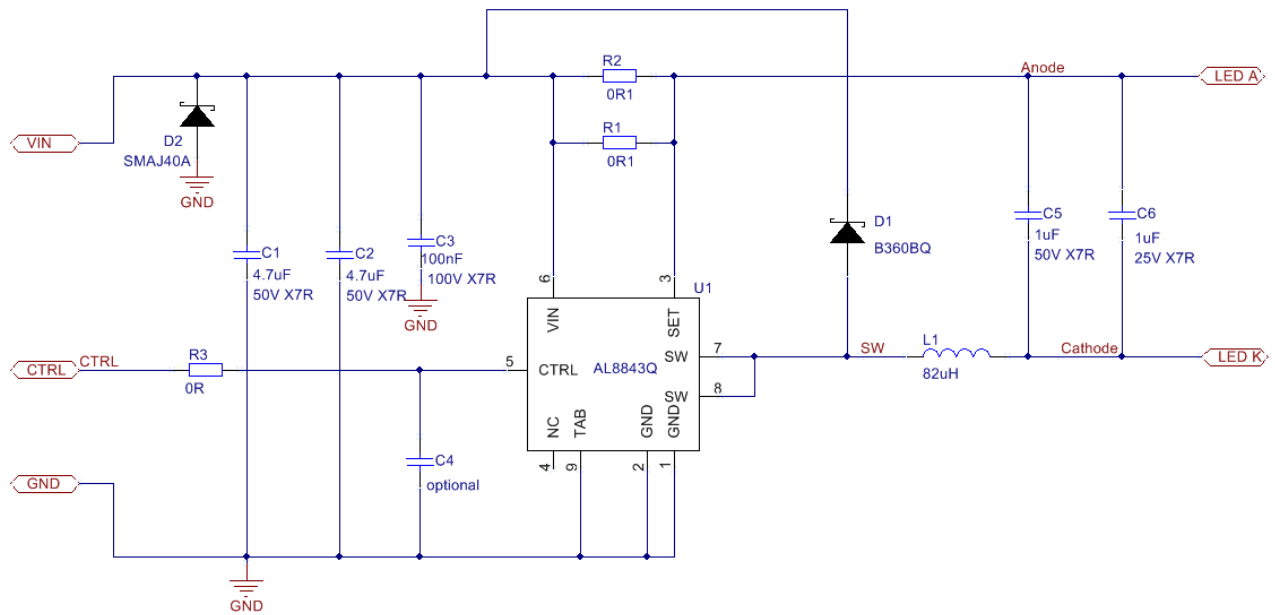

**Figure 3: Evaluation Board Schematic**

## Evaluation Board Layout

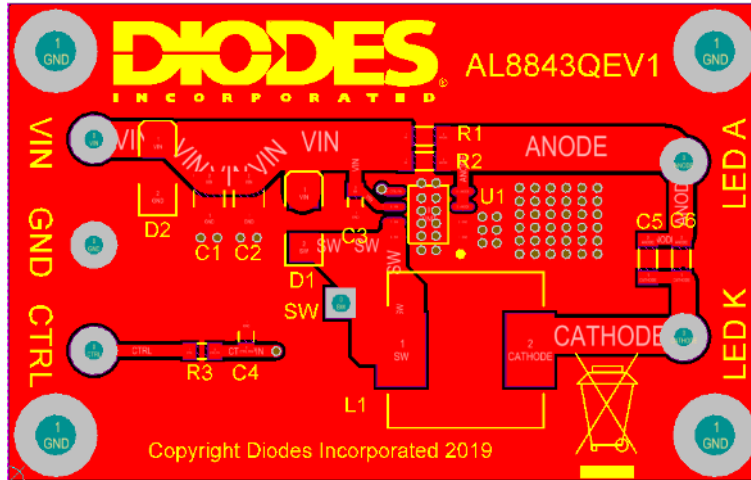

Figure 4: PCB Board Layout Top View

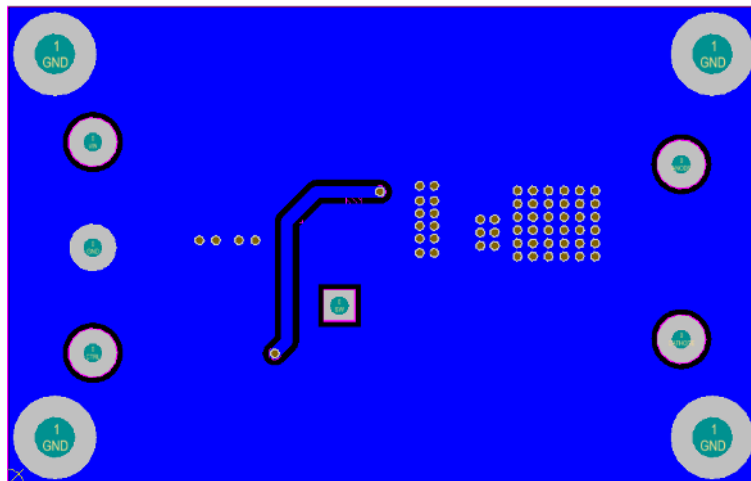

Figure 5: PCB Board Layout Bottom View

## Quick Start Guide

1. By default, the evaluation board is preset at 2A LED Current by R1 and R2.
2. Non-dimming operation: Leave CTRL pin floating for normal operation.
3. Power Supply: Connect the 5~40VDC to VIN & GND pin to supply the system and AL8843Q.
4. PWM Dimming: Remove C4; apply a PWM signal (low level < 0.3V and high level > 2.5) to CTRL pin to dim the LEDs. The recommended PWM signal frequency is from 100Hz to 1kHz, and the PWM duty is from 1% to 100%.
5. Analog Dimming: Connect 470nF capacitor to C4; the CTRL pin may be driven between 0.4V and 2.5V adjusting the output current from 10% to 100% of  $I_{LED}$ .

## Bill of Material

Ref	Value	Package	Part Number	Manufacturer	Notes
U1	AL8843Q	SO-8EP	AL8843QSP-13	Diodes	DC-DC converter
D1	60V, 3A	SMB	B360BQ-13-F	Diodes	Schottky diode
D2	40V	SMA	SMAJ40A	Diodes	TVS diode
R1, R2	0R100	1206		Generic	+/-1%
R3	0R	0805		Generic	+/-5%
C1, C2	4.7uF, 50V	1210	C1210X475K5RAC	Generic KEMET	X7R
C3	100nF, 100V	0805	Generic NMC0805X7R104K100	NIC Components	X7R
C4	Not Fitted	0805			Optional soft start capacitor
C5, C6	1uF, 100V	1206	Generic NMC1206X7R105K100	NIC Components	X7R
L1	82uH	1280	744770182	Würth Elektronik	82uH, ~0.16R, ~2.45A

Note: The component part numbers are correct at the time of publication. Diodes Inc reserves the right to substitute other parts where necessary, without further notification.

## Functional Waveforms

**Switching waveform(Vin=20V, 3LEDs)  
(Y-Vin, R-SW, B-CTRL, G-I<sub>L</sub>)**

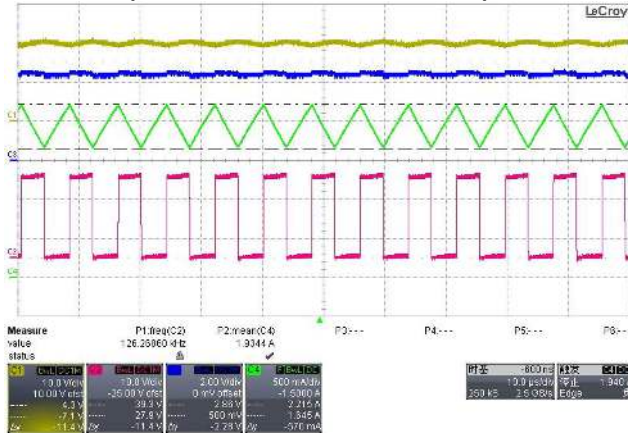

**Start-up waveform(Vin=20V, 3LEDs)  
(Y-Vin, R-SW, B-CTRL, G-I<sub>L</sub>)**

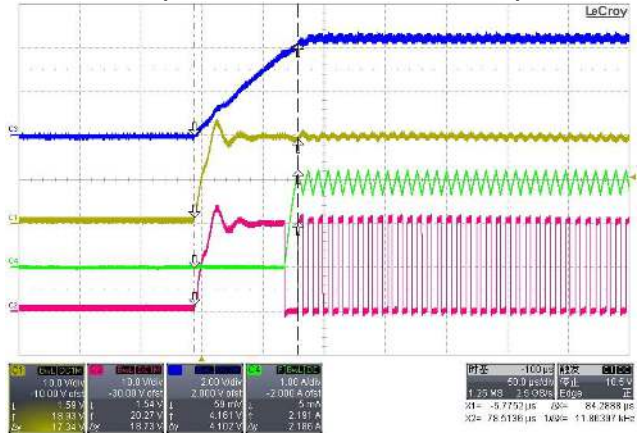

**Soft Start waveform  
(Vin=20V, 3LEDs, C4=10nF)  
(Y-Vin, R-SW, B-CTRL, G-I<sub>L</sub>)**

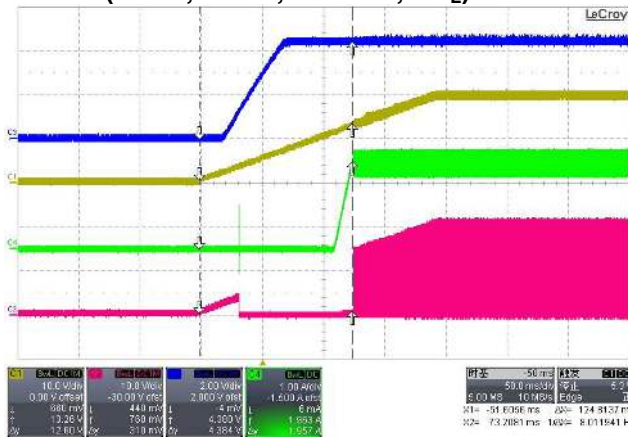

**PWM Dimming waveform(Vin=20V, 3LEDs)  
(PWM frequency=500Hz, Duty=80%)  
(Y-Vin, R-SW, B-CTRL, G-I<sub>L</sub>)**

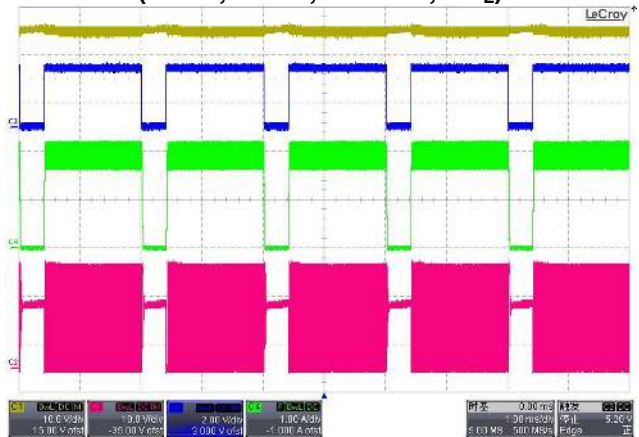

## Functional Waveforms

**PWM Dimming waveform(Vin=20V, 3LEDs)  
(PWM frequency=500Hz, Duty=50%)  
(Y-Vin, R-SW, B-CTRL, G-I<sub>L</sub>)**

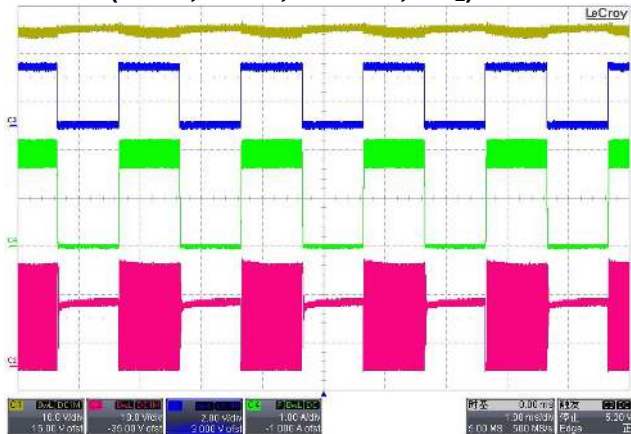

**PWM Dimming waveform(Vin=20V, 3LEDs)  
(PWM frequency=500Hz, Duty=20%)  
(Y-Vin, R-SW, B-CTRL, G-I<sub>L</sub>)**

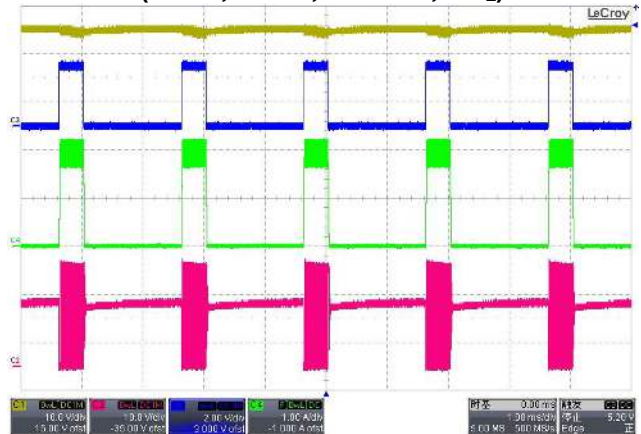

**LED open protection(Vin=20V, 3LEDs)  
(Y-Vin, R-SW, B-CTRL, G-I<sub>L</sub>)**

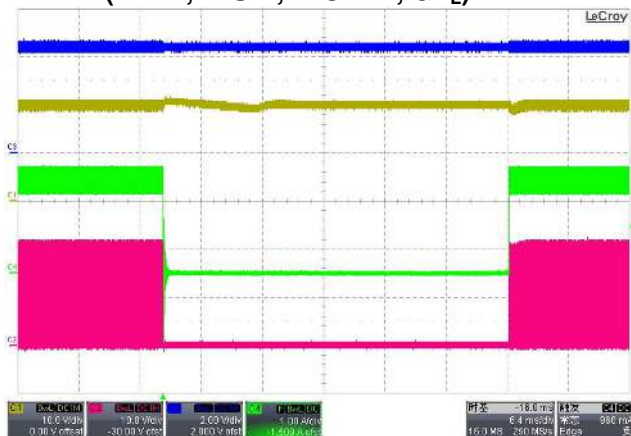

**LED short protection(Vin=20V, 3LEDs)  
(Y-Vin, R-SW, B-LED K, G-I<sub>L</sub>)**

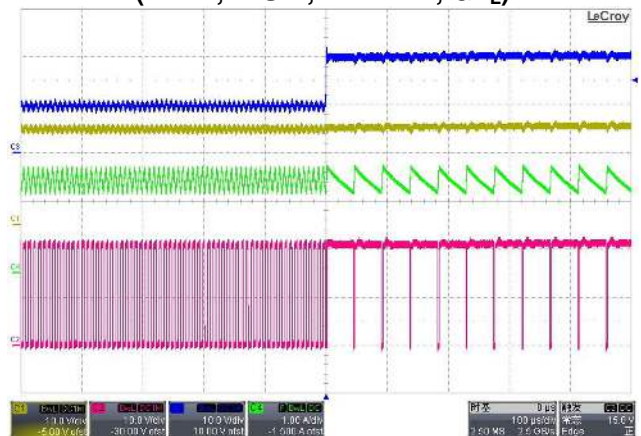

## Functional Data Curves

### Efficiency vs. Input Voltage

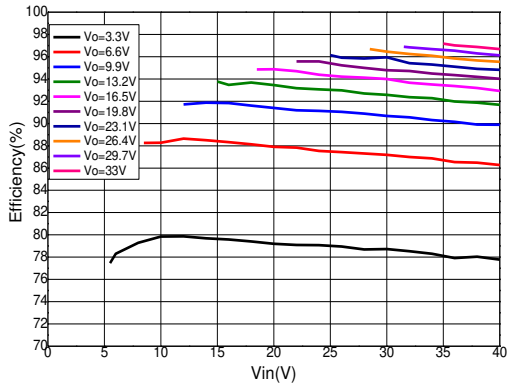

### LED Current vs. Input Voltage

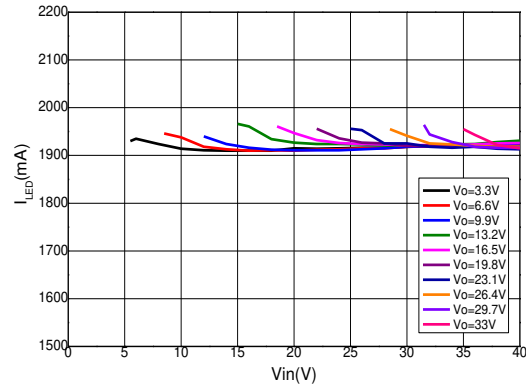

### Operating Frequency vs. Input Voltage

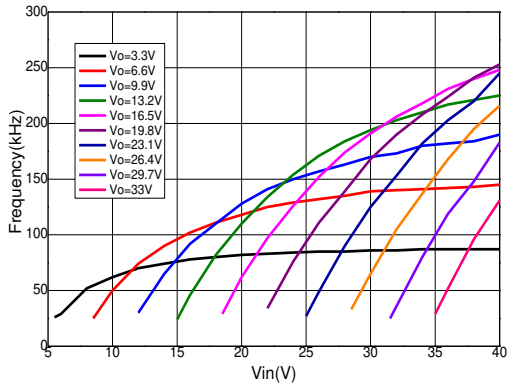

### PWM Dimming(Vin=20V, 3LEDs)

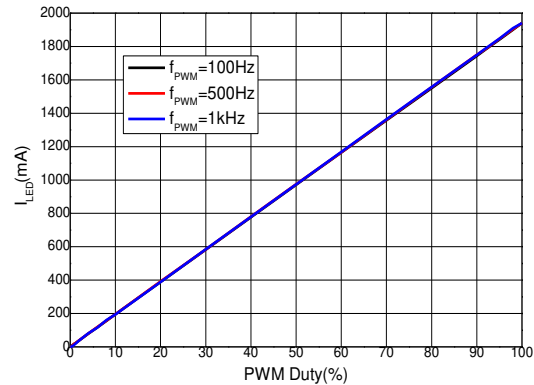

### Analog Dimming(Vin=20V, 3LEDs)

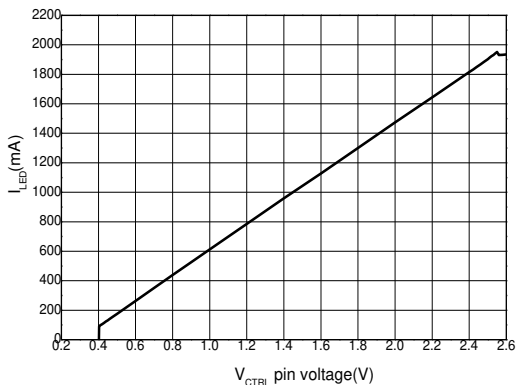



Thermal Test

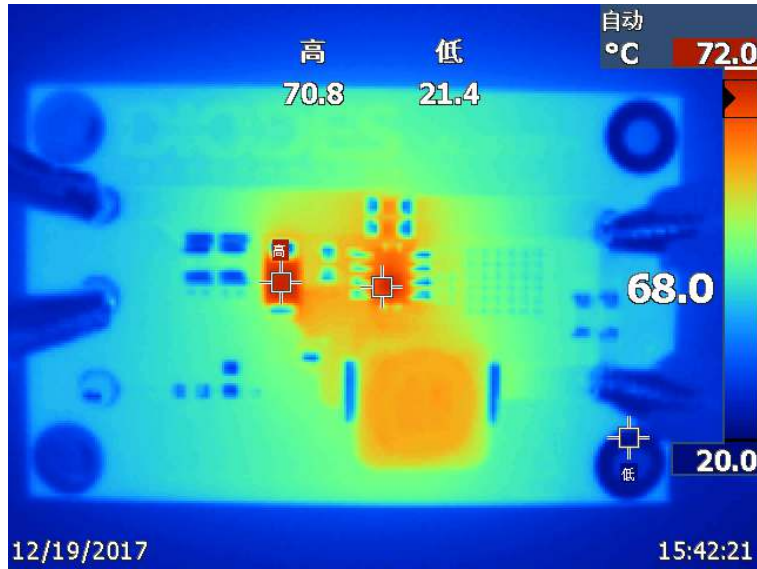

Figure 6: Top (Vin=20V, 3LEDs, Burn-in time=60min)

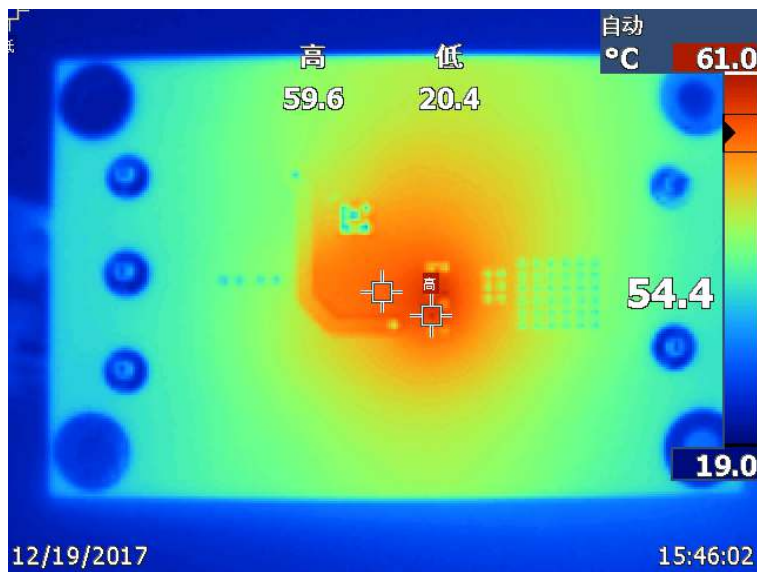

Figure 7: Bottom (Vin=20V, 3LEDs, Burn-in time=60min)

## IMPORTANT NOTICE

DIODES INCORPORATED MAKES NO WARRANTY OF ANY KIND, EXPRESS OR IMPLIED, WITH REGARDS TO THIS DOCUMENT, INCLUDING, BUT NOT LIMITED TO, THE IMPLIED WARRANTIES OF MERCHANTABILITY AND FITNESS FOR A PARTICULAR PURPOSE (AND THEIR EQUIVALENTS UNDER THE LAWS OF ANY JURISDICTION).

Diodes Incorporated and its subsidiaries reserve the right to make modifications, enhancements, improvements, corrections or other changes without further notice to this document and any product described herein. Diodes Incorporated does not assume any liability arising out of the application or use of this document or any product described herein; neither does Diodes Incorporated convey any license under its patent or trademark rights, nor the rights of others. Any Customer or user of this document or products described herein in such applications shall assume all risks of such use and will agree to hold Diodes Incorporated and all the companies whose products are represented on Diodes Incorporated website, harmless against all damages.

Diodes Incorporated does not warrant or accept any liability whatsoever in respect of any products purchased through unauthorized sales channel.

Should Customers purchase or use Diodes Incorporated products for any unintended or unauthorized application, Customers shall indemnify and hold Diodes Incorporated and its representatives harmless against all claims, damages, expenses, and attorney fees arising out of, directly or indirectly, any claim of personal injury or death associated with such unintended or unauthorized application.

Products described herein may be covered by one or more United States, international or foreign patents pending. Product names and markings noted herein may also be covered by one or more United States, international or foreign trademarks.

## LIFE SUPPORT

Diodes Incorporated products are specifically not authorized for use as critical components in life support devices or systems without the express written approval of the Chief Executive Officer of Diodes Incorporated. As used herein:

A. Life support devices or systems are devices or systems which:

1. are intended to implant into the body, or
2. support or sustain life and whose failure to perform when properly used in accordance with instructions for use provided in the labeling can be reasonably expected to result in significant injury to the user.

B. A critical component is any component in a life support device or system whose failure to perform can be reasonably expected to cause the failure of the life support device or to affect its safety or effectiveness.

Customers represent that they have all necessary expertise in the safety and regulatory ramifications of their life support devices or systems, and acknowledge and agree that they are solely responsible for all legal, regulatory and safety-related requirements concerning their products and any use of Diodes Incorporated products in such safety-critical, life support devices or systems, notwithstanding any devices- or systems-related information or support that may be provided by Diodes Incorporated. Further, Customers must fully indemnify Diodes Incorporated and its representatives against any damages arising out of the use of Diodes Incorporated products in such safety-critical, life support devices or systems.

Copyright © 2013, Diodes Incorporated

[www.diodes.com](http://www.diodes.com)