

## **TMP116EVM User's Guide**

---

---

---

The TMP116 devices are a family of high-precision digital temperature sensors with integrated EEPROM. The TMP116 family provides up to  $\pm 0.1^{\circ}\text{C}$  accuracy over the  $20^{\circ}\text{C}$  to  $42^{\circ}\text{C}$  range, and  $0.2^{\circ}\text{C}$  accuracy over the  $0^{\circ}\text{C}$  to  $85^{\circ}\text{C}$  range with 16-bit resolution. The TMP116EVM evaluation module (EVM) provides the user a simple way to get started with TMP116 family. The EVM features a perforation that allows the temperature sensor to be placed away from the MSP430 for remote temperature measurements.

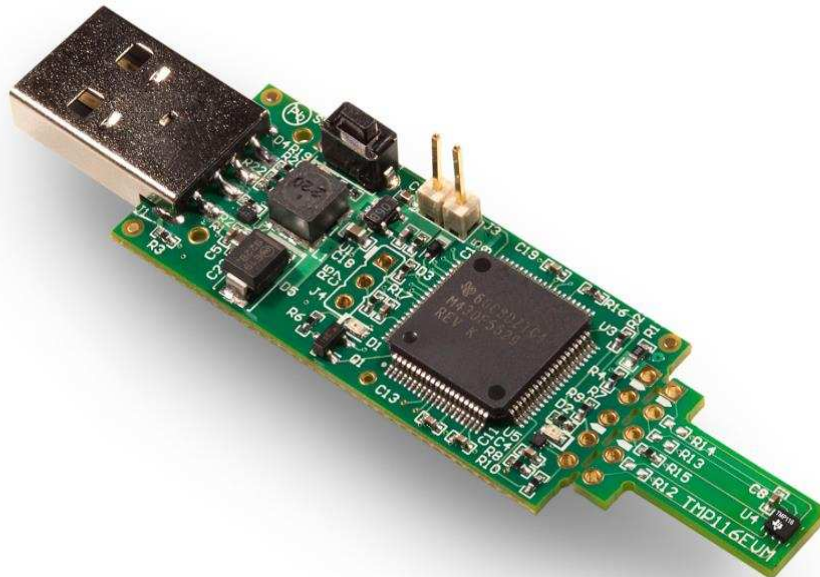

## Contents

1	Overview .....	3
2	EVM Kit Contents .....	3
3	Board Connectors and Components .....	4
4	Software Installation .....	6
5	Upgrading the Firmware .....	10
6	TMP116EVM Setup and Operation .....	14
7	Board Layout .....	20
8	Schematic and Bill of Materials .....	22

## List of Figures

1	TMP116EVM Evaluation Board .....	4
2	TMP116EVM Welcome .....	6
3	TMP116EVM License Agreement .....	7
4	TMP116EVM Installation Directory .....	7
5	TMP116EVM Select Components .....	8
6	Proxy Configuration .....	8
7	TMP116EVM Installation Finish .....	9
8	TMP116EVM Connection Diagram .....	10
9	Startup - Splash Screen .....	10
10	TMP116EVM GUI .....	11
11	Firmware Update Confirmation .....	11
12	Firmware Update .....	12
13	Firmware Upgrade Successfully .....	12
14	Update Firmware Failed .....	13
15	Confirmation of USB-to-I2C Converter Driver Installation .....	14
16	Default Configuration .....	14
17	TMP116EVM Default Tab .....	15
18	Registers Tab .....	17
19	Configuration Tab .....	18
20	TMP116 Setup .....	19
21	Top Assembly Layer .....	20
22	Top Layer Routing .....	20
23	Power Layer Routing .....	20
24	Ground Layer Routing .....	21
25	Bottom Layer Routing .....	21
26	Bottom Assembly Layer .....	21
27	TMP116EVM Schematic .....	22

## List of Tables

1	EVM Kit Contents .....	3
2	Device and Package Configurations .....	4
3	I2C Slave Addresses .....	5
4	TMP116EVM Bill of Materials .....	23

## 1 Overview

The TMP116EVM allows users to evaluate the performance of the best digital temperature sensor available in very small QFN package. The EVM comes in a USB stick form factor with an onboard MSP430F5529 microcontroller that interfaces with both the host computer and up to 4 TMP116 devices using I2C interface. The module is designed to provide user flexibility separating the TMP116 and MSP430 at the perforation location on the EVM board. The perforation allows the user to connect wires, cable, or header to both ends for remote temperature measurements or connects to desired system as well as connecting additional TMP116s.

## 2 EVM Kit Contents

[Table 1](#) details the contents of the EVM kit. Contact the Texas Instruments Product Information Center nearest you if any component is missing. It is highly recommended that you check the TI website at <http://www.ti.com> to verify that you have the latest versions of the related software.

**Table 1. EVM Kit Contents**

ITEM	QUANTITY
PCB test board: TMP116EVM	1
USB cable extender	1

### 3 Board Connectors and Components

The jumpers and connectors on the EVM, and how to properly connect, set up and use the TMP116 Bench Board are described here.

#### 3.1 Input/Output Connector Description and Components

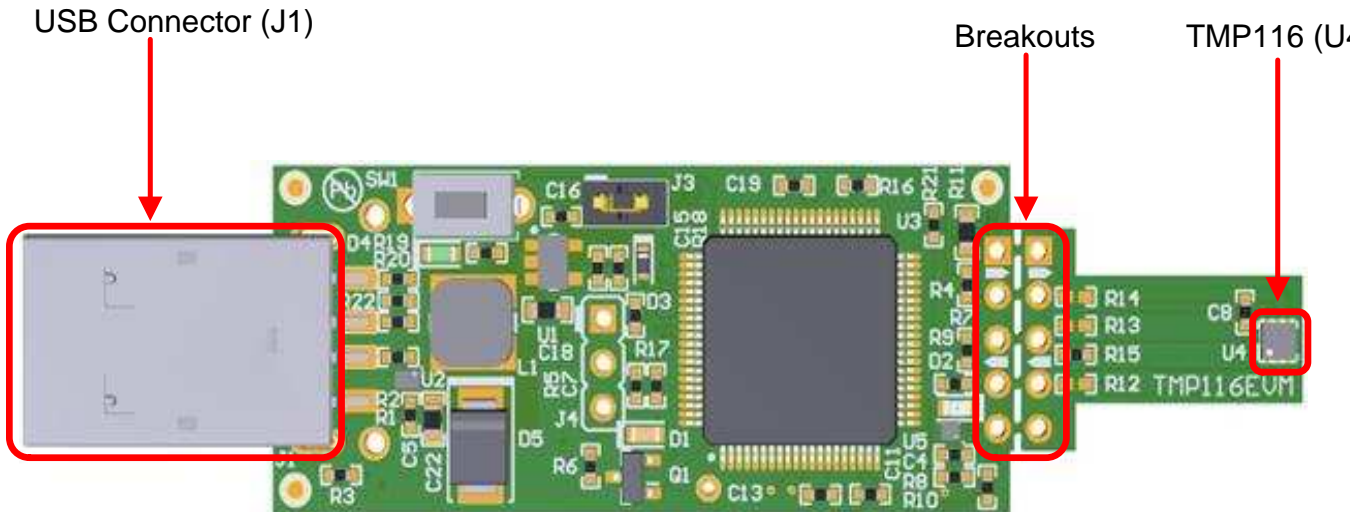

**Figure 1. TMP116EVM Evaluation Board**

**Table 2. Device and Package Configurations**

DEVICE	IC	PACKAGE
U4	TMP116AIDRVR	WSON (6)

##### 3.1.1 EVM Power Supply Input – J3

TMP116EVM utilizes the +5V input power supply of the USB connector to power the EVM. The EVM does not require an external power supply. The board is powered by the USB port and provides switched +5V. It can be powered by shorting the J3 jumper with a regulated voltage with desired voltage based on the equation 1. The EVM power supply input can be changed to any input power supply range of the TMP116 1.9V to 5.5V; however, note MSP430 can only support power supply range 2.3V to 3.6V with recommends  $V_{OH}$  and  $V_{OL}$  conditions per [TMP116](#) datasheet specifications.

The resistor adjust  $R_{ADJ}$  can be calculated as given by the [Equation 1](#) where  $V_{REF}=1.23V$  and desired voltage of  $V_{OUT}$ .

$$V_{OUT} = V_{REF} + \left[ V_{REF} \times \left( \frac{R_{ADJ}}{51.1k\Omega} \right) \right] \quad (1)$$

$$R_{ADJ} = 51.1k\Omega \times \left[ \left( \frac{V_{OUT}}{V_{REF}} \right) - 1 \right] \quad (2)$$

##### 3.1.2 Interface Connector – J1

J1 is the USB connector, and used to connect the PC. The interface is used to access the device's registers and read the conversion data from the TMP116 via I2C communication protocol.

### 3.1.3 Debug Jumper – J4

J4 is the connector that allows debugging the firmware using three wires instead of the standard 14 pins header. This connector is not populated.

### 3.1.4 Pushbutton Switch – SW1

Basically, the SW1 is to bring the MSP430 into a BSL mode for upgrading the firmware with combination of the USB connector manually referring to the picture in [Figure 1](#) BSL button (SW1 switch). Press and hold the switch SW1 next to the USB connector while plugging the USB cable from the board to the PC. This will allow bringing the MSP430 into BSL mode; however, the firmware software will automatically put the MSP430 into BSL mode, refer to firmware upgrade section.

### 3.1.5 Header Connector – J2

The purpose of the header connector is to isolate the heat source from coming directly to the TMP116, and the perforation allows user to snap at the break tab and connect via wires or header to both ends for remote temperature measurements.

### 3.1.6 LED – (D1, D2, D4)

There are a total of three LEDs on the board: green (D4), red (D2), and orange (D1). The green LED is the power supply indicator, and it should be turn ON. The orange LED should not blink when the EVM is initially plugged into the PC. The orange LED will blink if the power on reset tests on the MSP430 microcontroller fails on startup or if the Test LED button is toggled. The orange LED will blink when the Start Graph button is pressed. The red LED is the Alert pin indicator when the Alert pin is pulling LOW.

### 3.1.7 I2C Slave Addresses – (R12, R13, R14, R15)

TMP116 is capable of supporting 4 I2C 7-bit addresses. The TMP116 is connected to the bus by a unique slave address to operate data transfer from the master-transmitter to the slave-receiver or slave-transmitter to the master-receiver. The TMP116 can be configured desired four serial bus addresses depending on the state of the ADD0 as [Table 3](#). At default, the resistor R15 is soldered, and configured for 0x48h address.

**Table 3. I2C Slave Addresses**

CORRESPONDING EVM RESISTOR	ADD0 PIN CONNECTION	SLAVE ADDRESS	
		BINARY	HEX
R15	GND	1001000	0x48
R13	V+	1001001	0x49
R14	SDA	1001010	0x4A
R15	SCL	1001011	0x4B

## 4 Software Installation

### 4.1 Graphical User Interface (GUI)

The EVM software is tested on the Microsoft Windows 7 and 10 operating system (OS). The software also functions on other Windows operating systems. The EVM software is available through the EVM product folder on the TI website.

1. Go to the TMP116EVM web page on the TI website: <http://www.ti.com/tool/TMP116EVM>. Scroll down to the “Software” section and download the latest evaluation software.
2. Unzip the downloaded file into a known directory, and run the “Setup\_TMP116EVM\_GUI.exe” file located in [Unzip location]. The EVM software installer then begins the installation process.

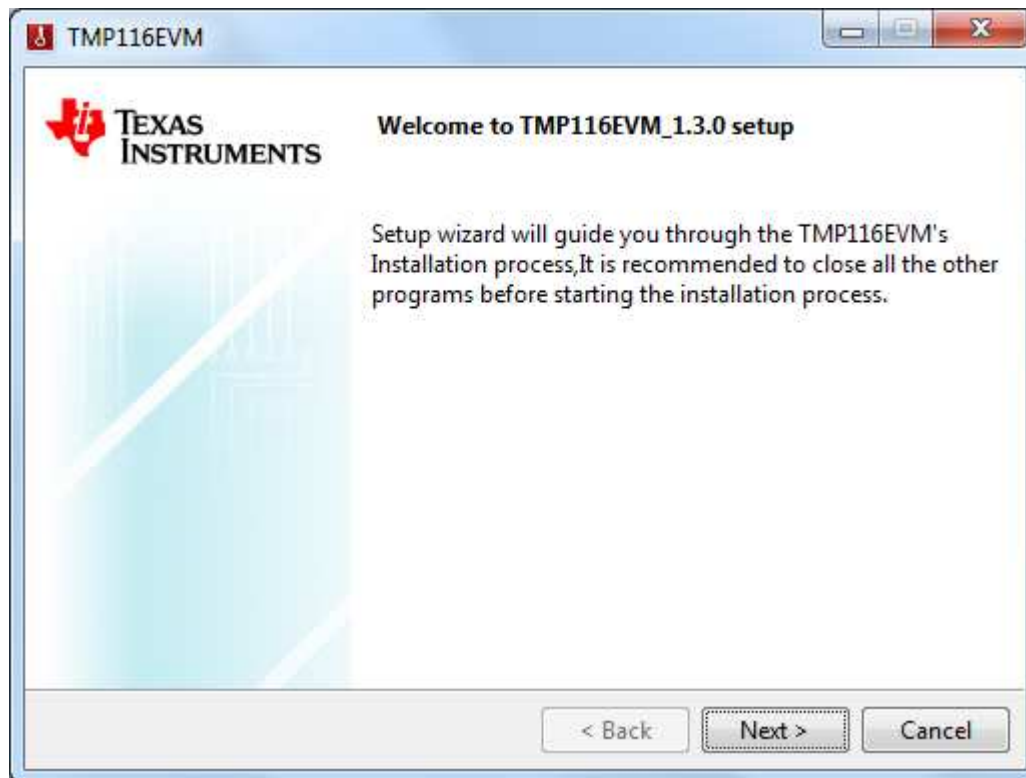

**Figure 2. TMP116EVM Welcome**

3. Follow the on-screen instructions by clicking the “Next” button to install the software.

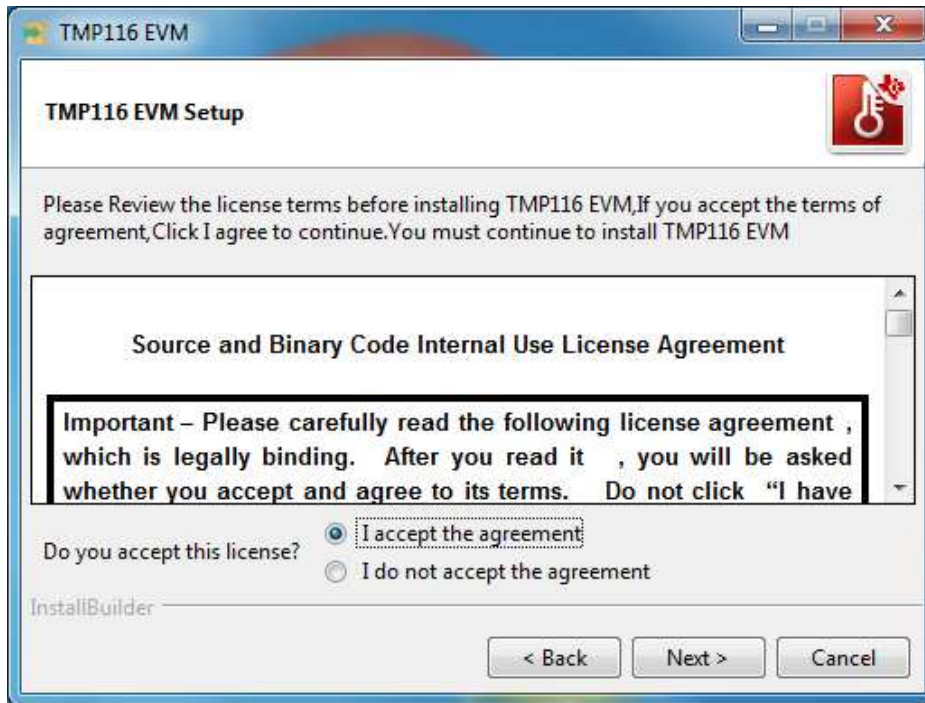

**Figure 3. TMP116EVM License Agreement**

4. Following this option, two license agreements are presented that must be accepted.

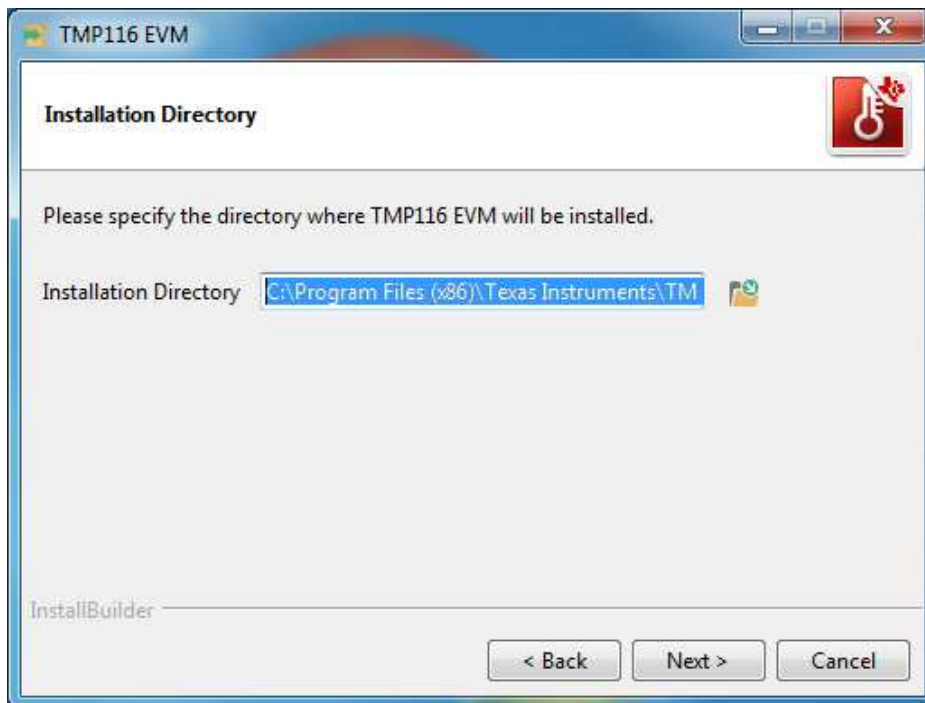

**Figure 4. TMP116EVM Installation Directory**

- Click on the "Next" button to accept the default installation directory.

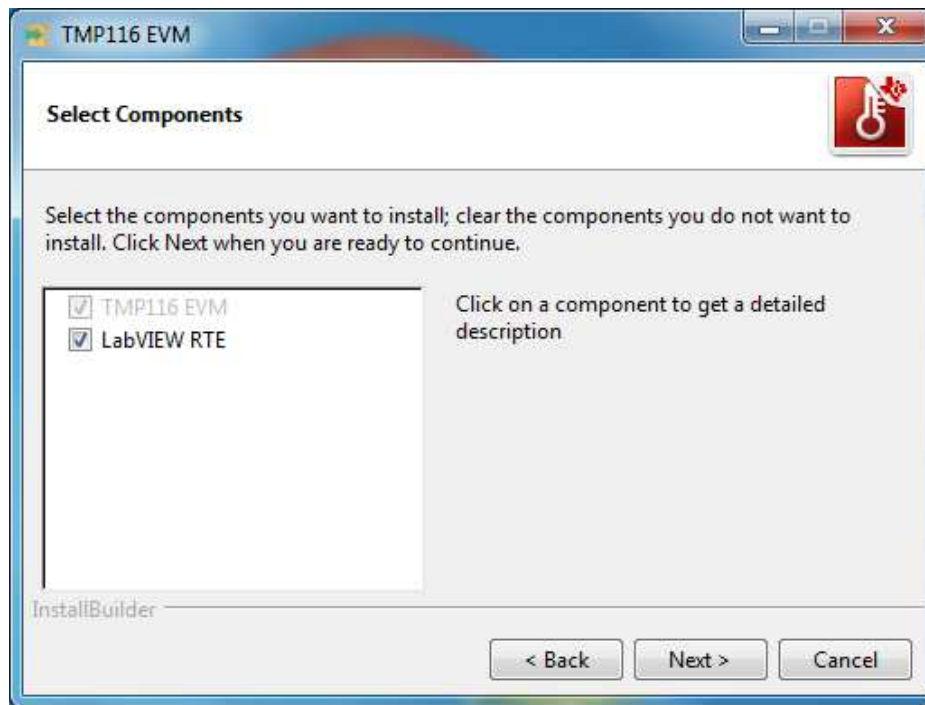

**Figure 5. TMP116EVM Select Components**

- If it is the first time installation, ensure the "LabVIEW runtime engine 2016" is listed in the following summary. TMP116EVM GUI is required LabVIEW 2016 runtime engine in order proper operation.

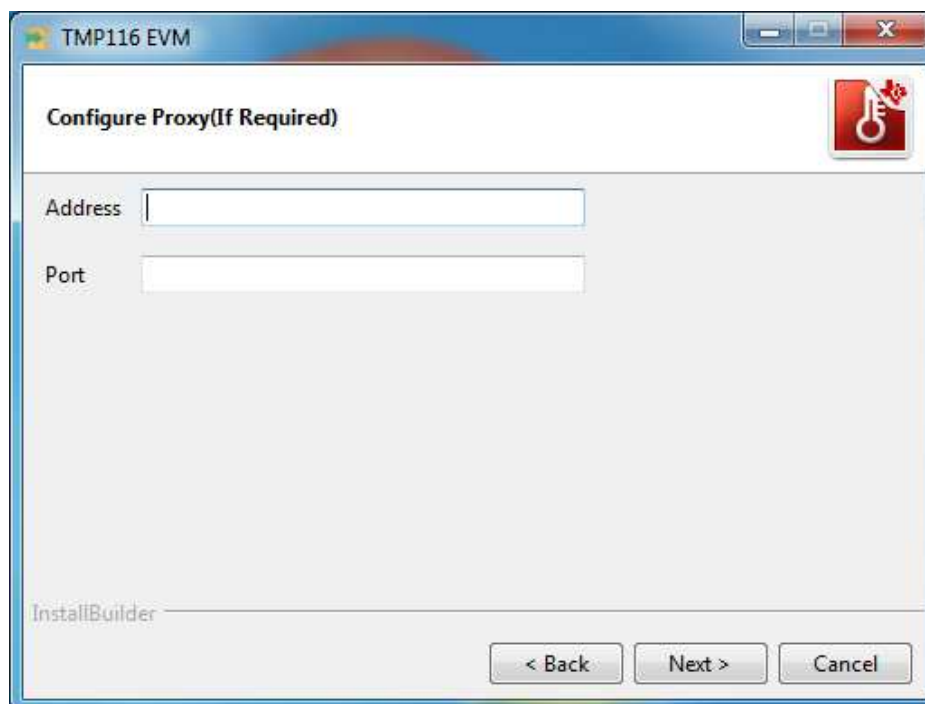

**Figure 6. Proxy Configuration**



7. Some server requires to configure the proxy before authorized users gains access to the web. If so, please provide your server address and port number. If the server doesn't require the proxy server, just simply delete the default address and port number.

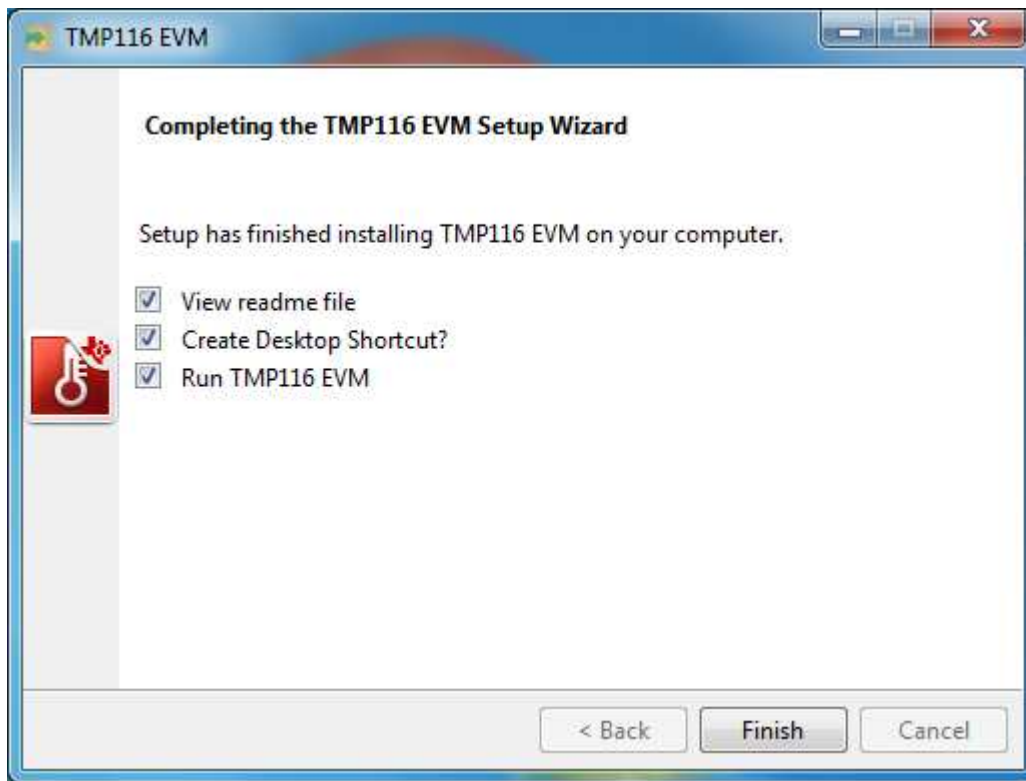

**Figure 7. TMP116EVM Installation Finish**

8. When the installation is finished, please click “Finish” button and restart the computer.

## 5 Upgrading the Firmware

This is how to perform the firmware upgrade of the TMP116EVM board.

**CAUTION**  
 TMP116EVM software must be installed before performing any tasks.



**Figure 8. TMP116EVM Connection Diagram**

1. Short J3 header connector with a shunt. Do not plug the USB cable to the PC yet.
2. Locate the latest firmware from this directory C:\Program Files (x86)\Texas Instruments\TMP116EVM\Firmware\. The current firmware revision is 2.7V. The firmware is a text file.
3. Connect the TMP116EVM to a PC in [Figure 8](#).
4. With the TMP116EVM connected, launch the TMP116EVM GUI application. The application can be launched from Start -> Programs -> Texas Instruments -> TMP116EVM -> TMP116EVM.exe. Run the aforementioned TMP116EVM GUI.
5. Once the GUI launched, put the software into “Demo” mode see [Figure 9](#). The version number of the current firmware is shown in the “Setup” tab by clicking the “Read” button. A pop-up window automatically will appear if the current firmware on the EVM needs to be upgraded. If not, please follow the instruction .



**Figure 9. Startup - Splash Screen**

6. An error window that appears if the computer cannot communicate with the EVM. This is due to the driver not installed yet. On top right of the GUI, “Demo Mode” checkbox should be checked as shown in red box.
7. Click the “Update Firmware” button. This will launch the firmware loader software.

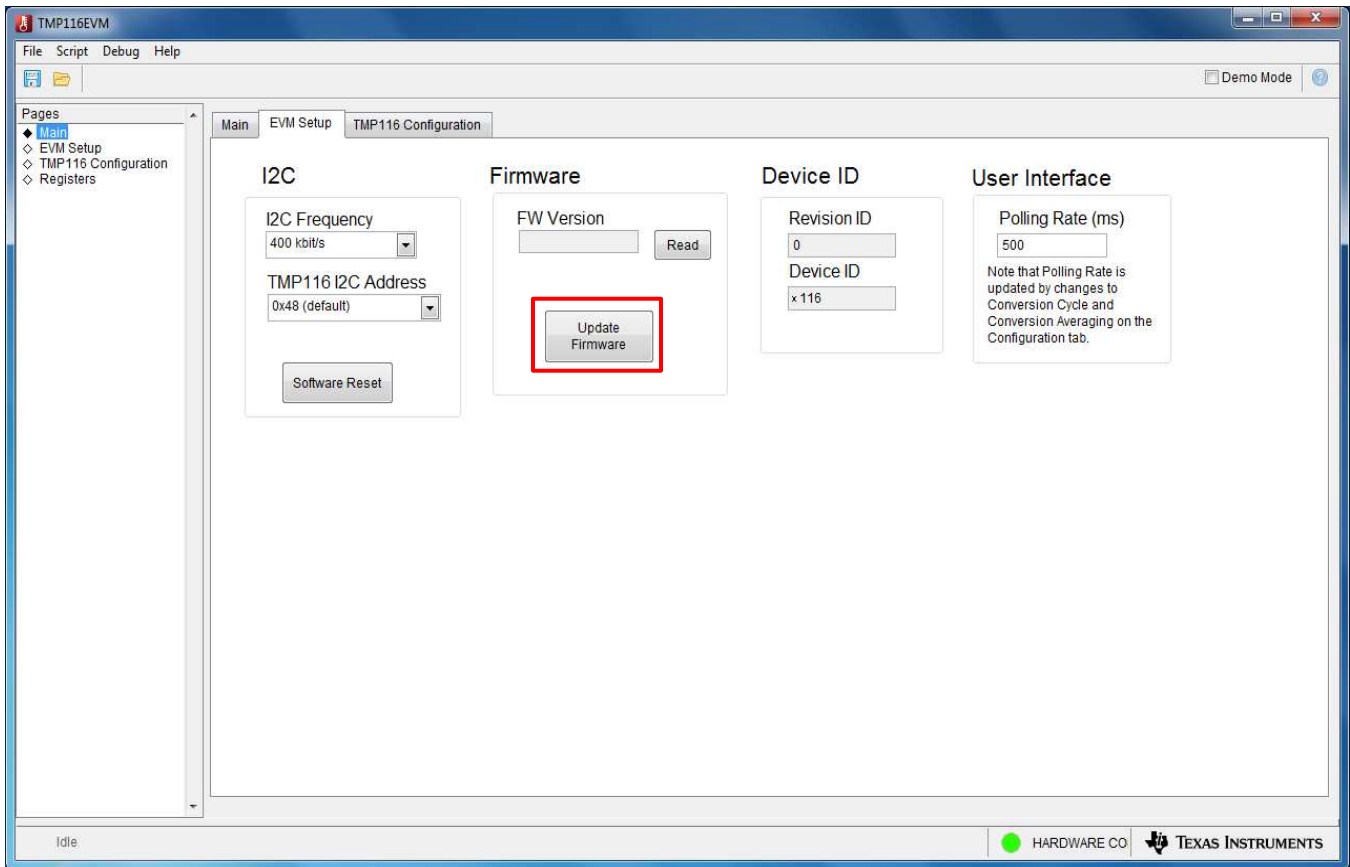

**Figure 10. TMP116EVM GUI**

8. [Figure 11](#) appears. Click the “OK” button to precede the firmware update.

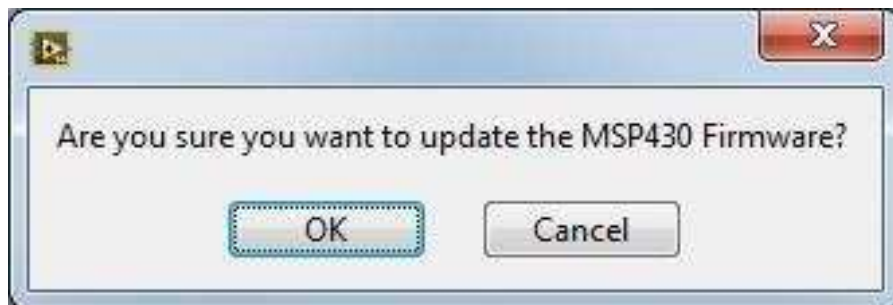

**Figure 11. Firmware Update Confirmation**

9. The firmware loader will automatically check if the current firmware is programmed, and automatically update the firmware see [Figure 12](#).

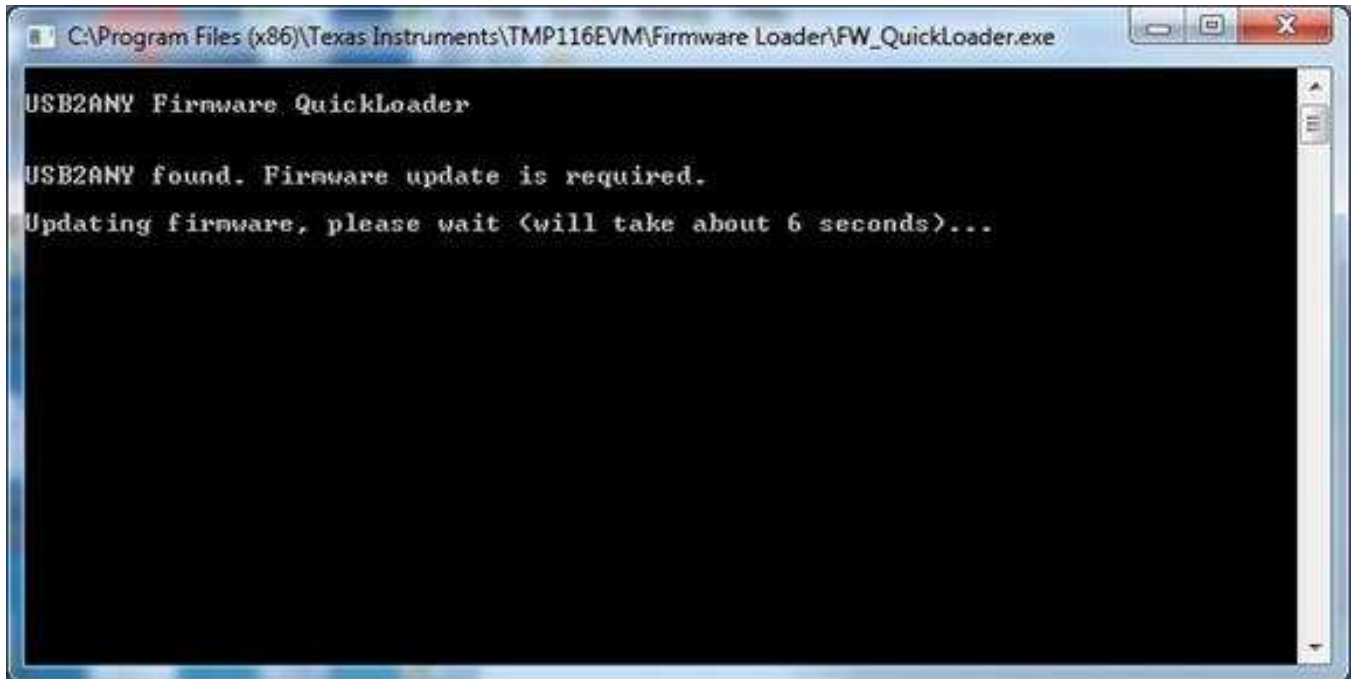

**Figure 12. Firmware Update**

10. It's required a few second to program the firmware. Once the program is completed, an indicator message is shown in [Figure 13](#).



**Figure 13. Firmware Upgrade Successfully**

11. Sometimes the Firmware Quickloader indicated a failed to update the firmware. The message can be ignored, and proceed to validation in the TMP116EVM GUI.

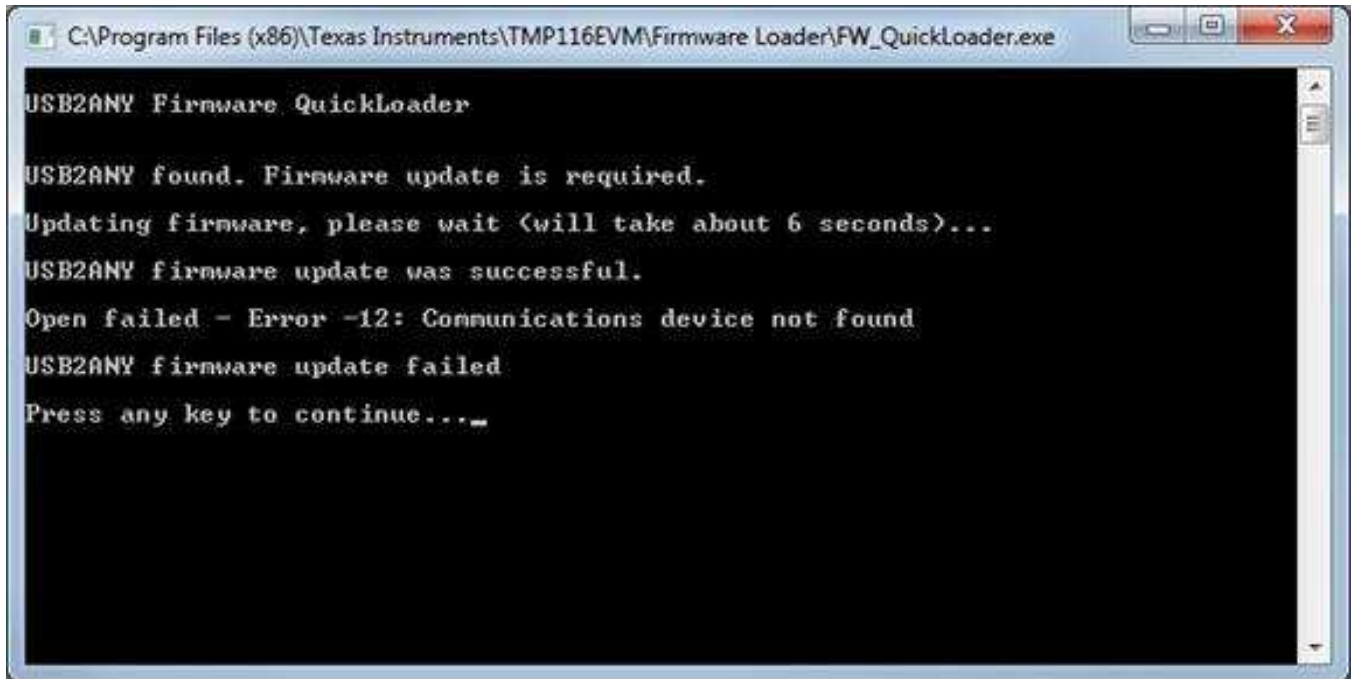

```

C:\Program Files (x86)\Texas Instruments\TMP116EVM\Firmware Loader\FW_QuickLoader.exe
USB2ANY Firmware QuickLoader
USB2ANY found. Firmware update is required.
Updating firmware, please wait (will take about 6 seconds)...
USB2ANY firmware update was successful.
Open failed - Error -12: Communications device not found
USB2ANY firmware update failed
Press any key to continue...
  
```

Figure 14. Update Firmware Failed

## 6 TMP116EVM Setup and Operation

### CAUTION

Do not exceed the power supply rating of the MSP430.

### 6.1 Launching and Running the Software

The TMP116EVM is recognized by the host as a generic human interface device (HID); therefore, there is no proprietary driver required to install on your PC. It shows the typical response to connecting the USB-to-I2C converter board to a PC USB port for the first time. Typically, the computer responds with a Found New Hardware, USB device pop-up dialog. The pop-up window then typically changes to Found New Hardware, USB Human Interface Device. This pop-up indicates that the device is ready to be used. The USB-to-I2C Converter uses the human interface device drivers that are part of the Microsoft Windows® operating system.

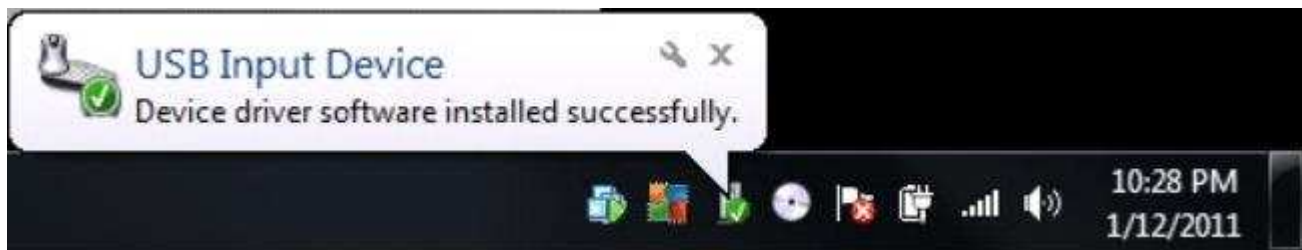

**Figure 15. Confirmation of USB-to-I2C Converter Driver Installation**

The TMP116EVM GUI can be run from the Start Menu or from Windows desktop. It is located in a folder Start -> Programs -> Texas Instruments -> TMP116EVM -> TMP116EVM.exe. Clicking on the “OK” button will take you to the main window of the GUI.

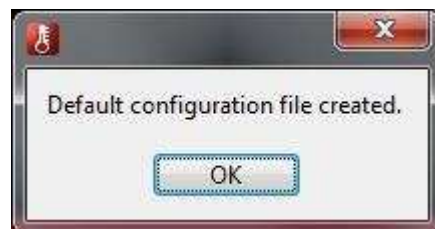

**Figure 16. Default Configuration**

1. Connect the TMP116EVM to a USB port on a PC as shown in [Figure 16](#).
2. Launch the TMP116EVM software by clicking on Start >> All Program >> Texas Instruments >> TMP116 EVM >> TMP116EVM.exe. The TMP116 EVM GUI should automatically initialize and connect to the HID port. A successful connection will show “HARDWARE CONNECTED” highlighted in green color on the bottom of the GUI status indicator. If there is a connection problem please verify if the TMP116EVM has an established connection with the PC. A fail connection if the status indicator shows as “DEMO MODE”.

## 6.2 Tab Pages Selection

The tab pages selection consists of three tabs, Main (Temperature Graph), EVM Setup, and TMP116 Configuration. Launching the software will take you to the main window GUI (Main tab) display. By clicking on the page tab allows switching between pages of the tab control.

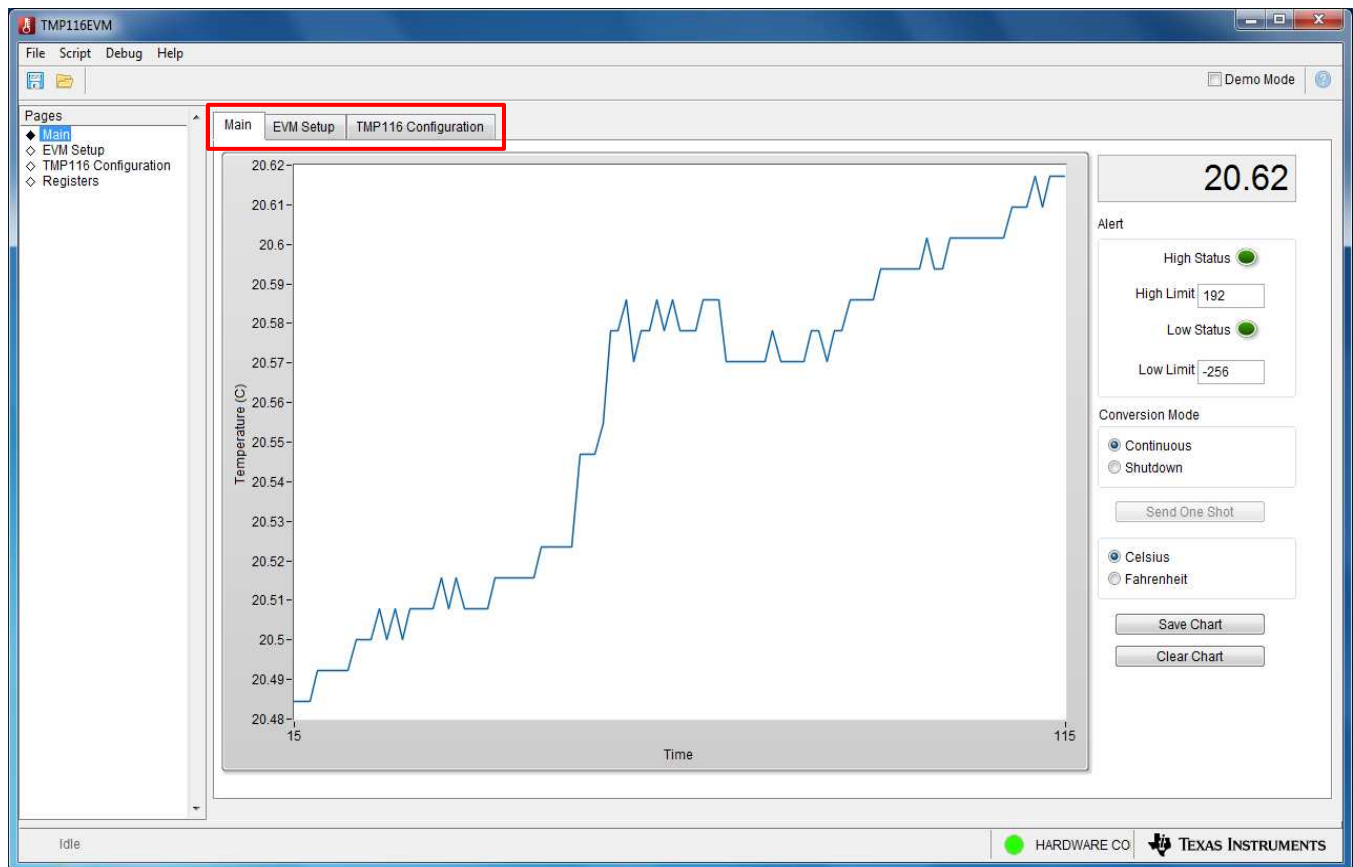

Figure 17. TMP116EVM Default Tab

### 6.3 Main Tab

The “Main” tab provides graphing the temperature result as well as other features.

**Clear Chart** erases the contents of the Temperature Chart box or click right button of the mouse on the display screen then select “Clear chart”.

**Save Chart** prompts for a file name, and then saves the contents of the current Temperature graph box to \*.csv file.

**Current Value** shows the current temperature of the TMP116.

**Celsius or Fahrenheit** is to toggle the temperature conversion Celsius to Fahrenheit.

**One Shot** is available on the Temperature Chart tab. The One Shot button writes to the TMP116 configuration register with the one-shot in conversion mode. This setting initiates a temperature conversion within the TMP116 device that updates the temperature result registers. After the one-shot conversion finishes, the device goes into shutdown, and wait for the time based on the averaging bits setting written in the configuration register.

**Continuous** performs the temperature conversion continuously when the MOD[1:0] bits are configured in the configuration register to 00. Each temperature conversion consists of an active conversion period followed by a standby period based on the time of the conversion cycle and conversion averaging configuration.

**Alert high and low limit register** can be set by entering the value in °C or °F based on °C/°F control on Main tab that stores the high and low limit for comparison with the temperature result.



### 6.4 Register Tab

The “Registers” tab provides access to the registers of the TMP116, performing read and writes commands. Changes to the configuration page are mirrored here, and vice versa. For more details about each register refer to the latest datasheet.

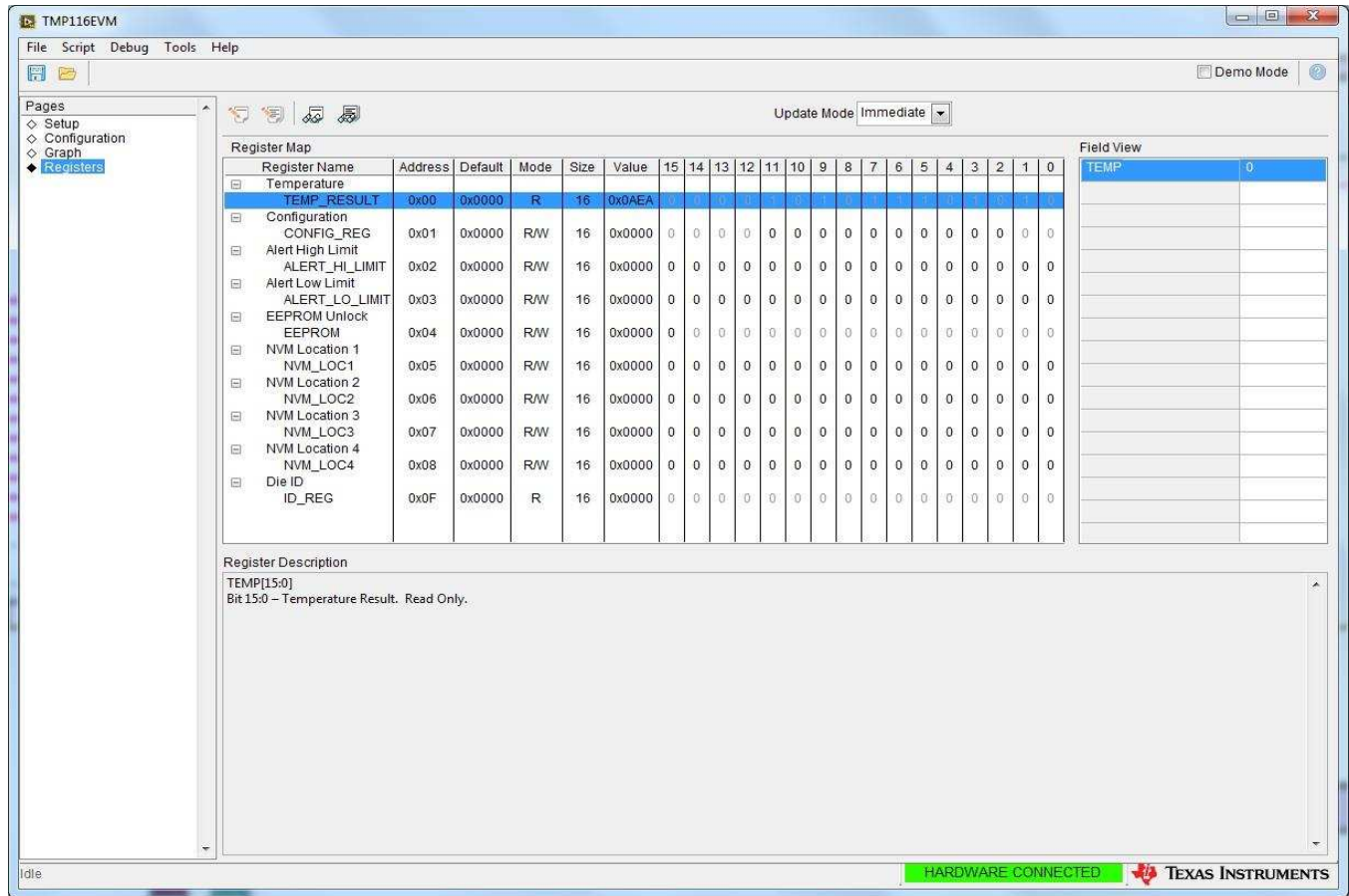
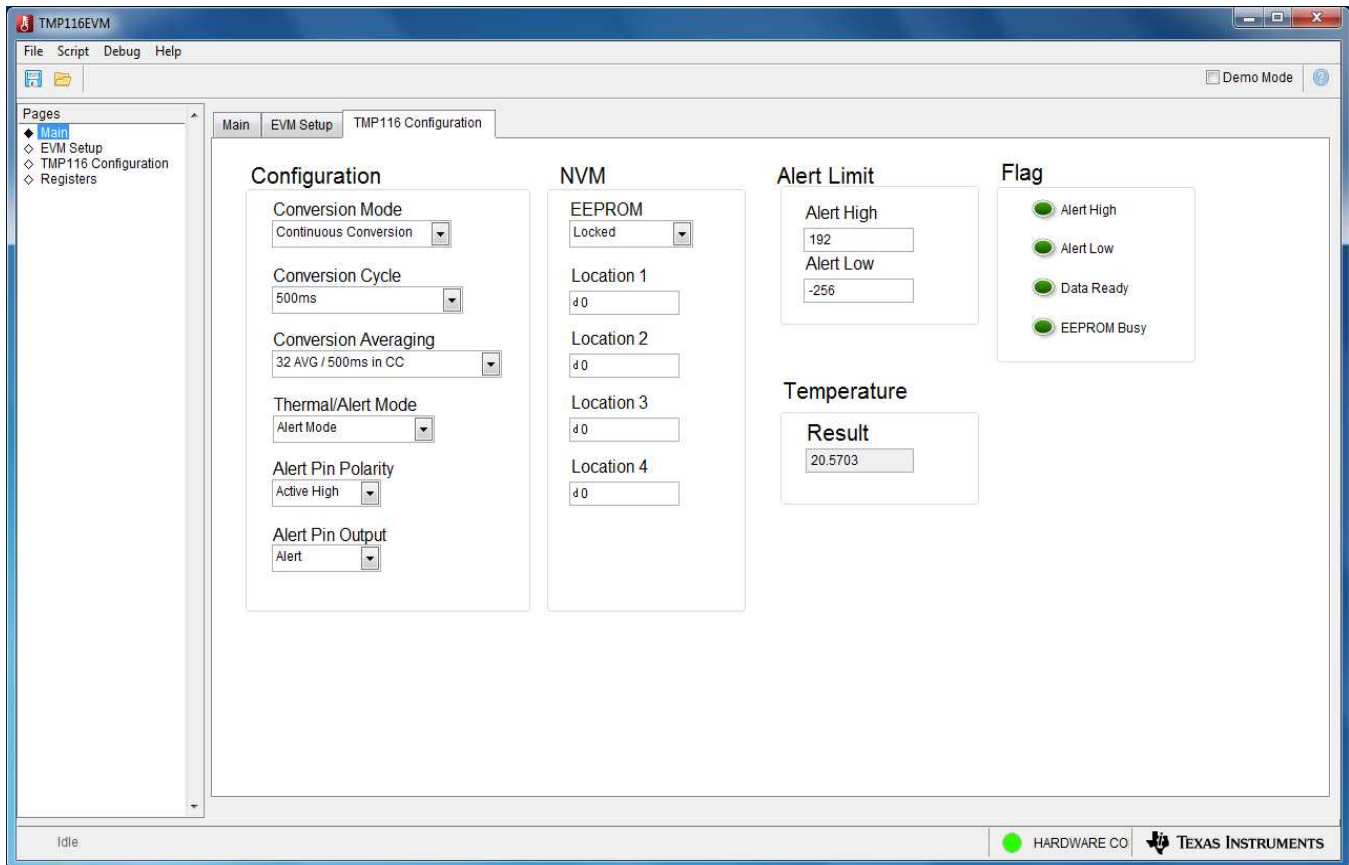

Figure 18. Registers Tab

## 6.5 Configuration Tab



**Figure 19. Configuration Tab**

**Configuration register** can be set to desired value by selecting the drop-down menu.

**Non-volatile memory** can be programmed by entering the value at the location 1 to 4 then use the EEPROM dropdown menu to lock the value.

**Alert high and low limit register** can be set by entering the value in °C/°F based on setting of the Main tab.

**Status indicator** displays the outputs by clicking on the “Read Status” button.

**Temperature** displays the current temperature of the TMP116.

## 6.6 EVM Setup Tab

It is necessary to configure the TMP116 slave address as 0x48 for communication with the EVM-GUI. This is the default slave address.

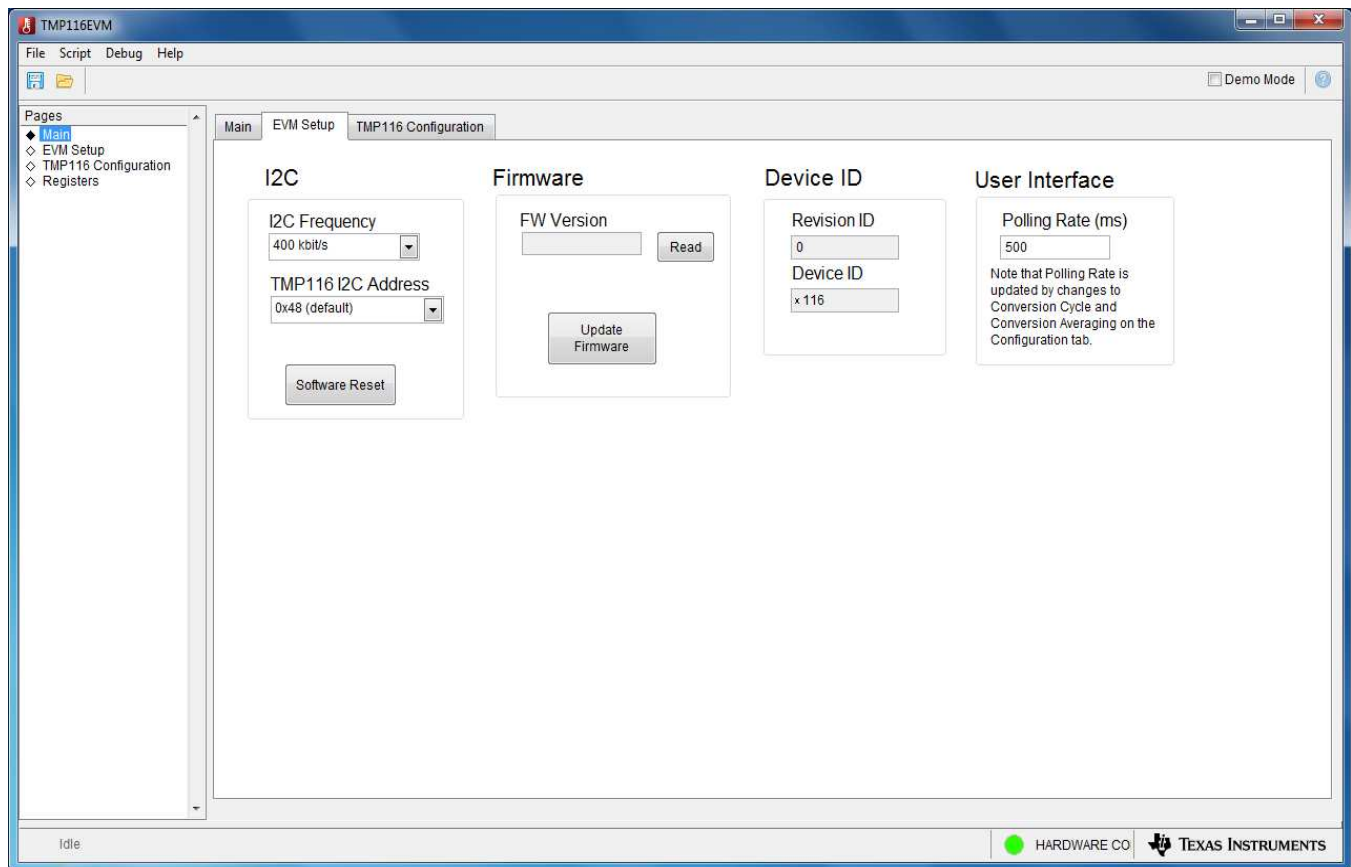

**Figure 20. TMP116 Setup**

**Firmware** is allowed to check the firmware revision on the MSP430F5529 microcontroller by clicking the “Read” button or update the firmware revision.

**I2C Configuration** is to change the bus frequency and slave address.

**Device ID** is to read device identification.

**Software Reset** performs software reset on the TMP116 device by issuing a general call. After software reset, the values displayed in the EVM software may be out of sync with the device register contents. To sync register contents after software reset, click Read All in the Registers tab page.

**Demo Mode** allows to operate the GUI without a hardware connected. In this mode, the handle is closed. Clicking on any buttons or drop-down menu will be automatically closed the software GUI.

**User Interface** polling rate refers to the time interval at which the GUI software queries the TMP116 device. It can be configured here, but it will be changed automatically when changes are made to Conversion Cycle and Conversion Average.

## 7 Board Layout

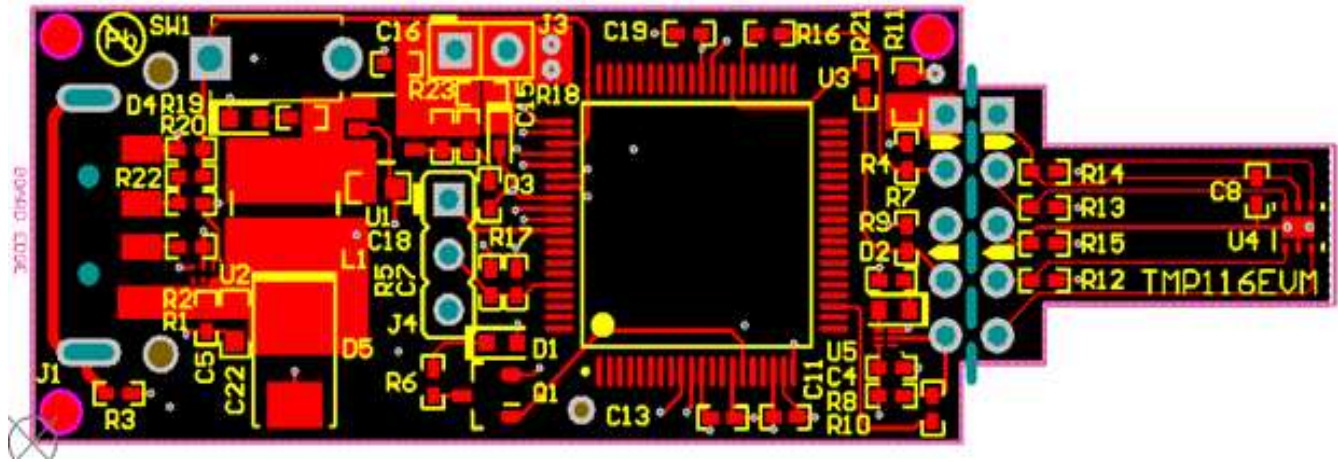

Figure 21. Top Assembly Layer

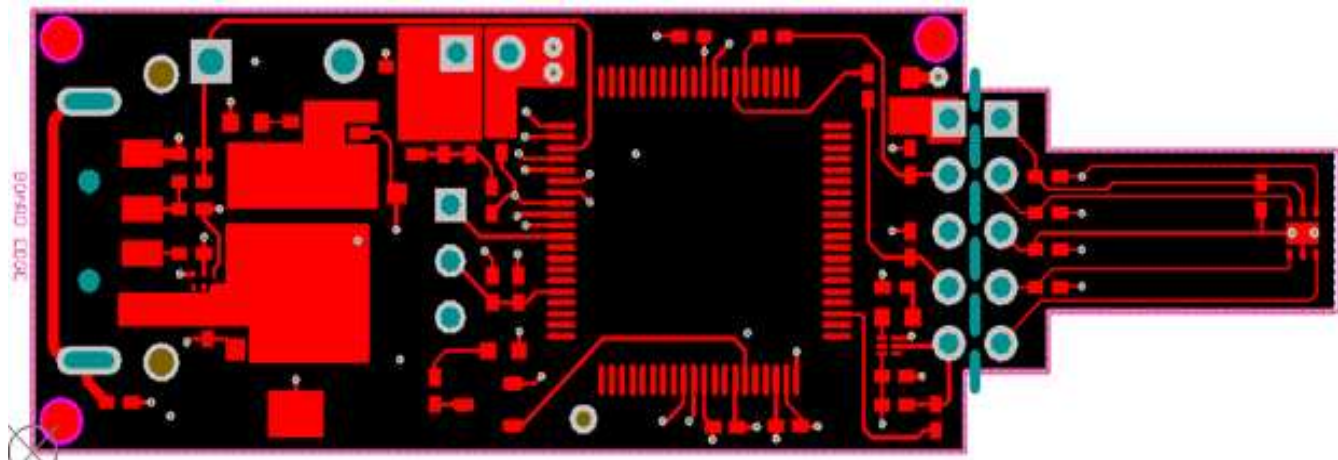

Figure 22. Top Layer Routing

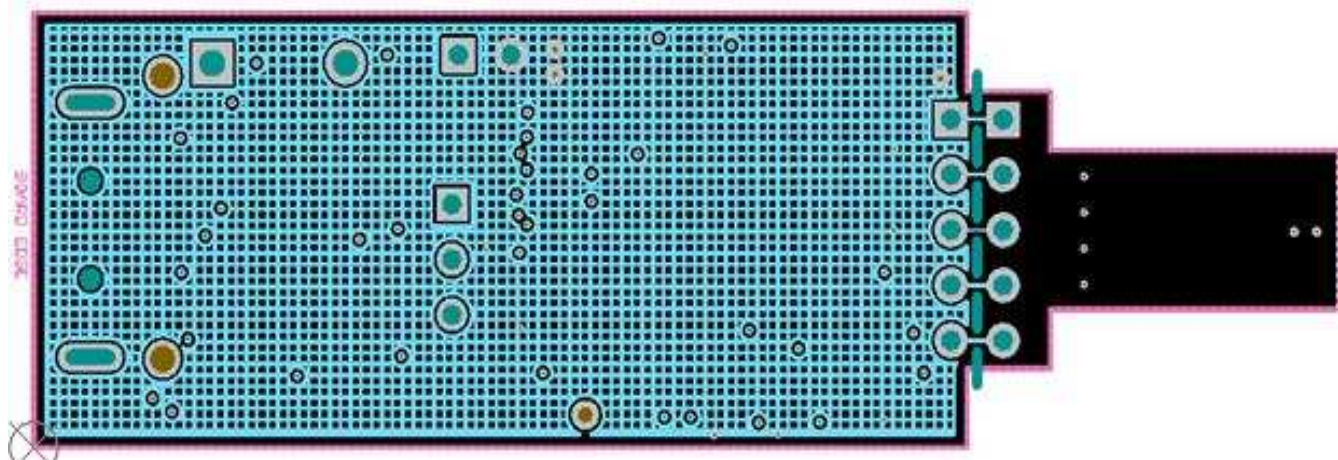

Figure 23. Power Layer Routing

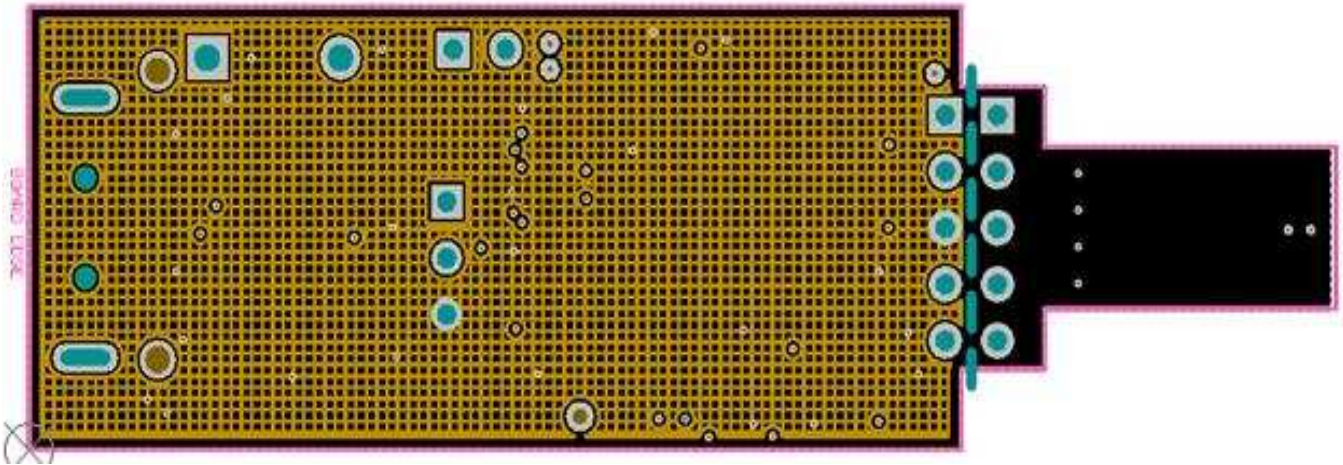

Figure 24. Ground Layer Routing

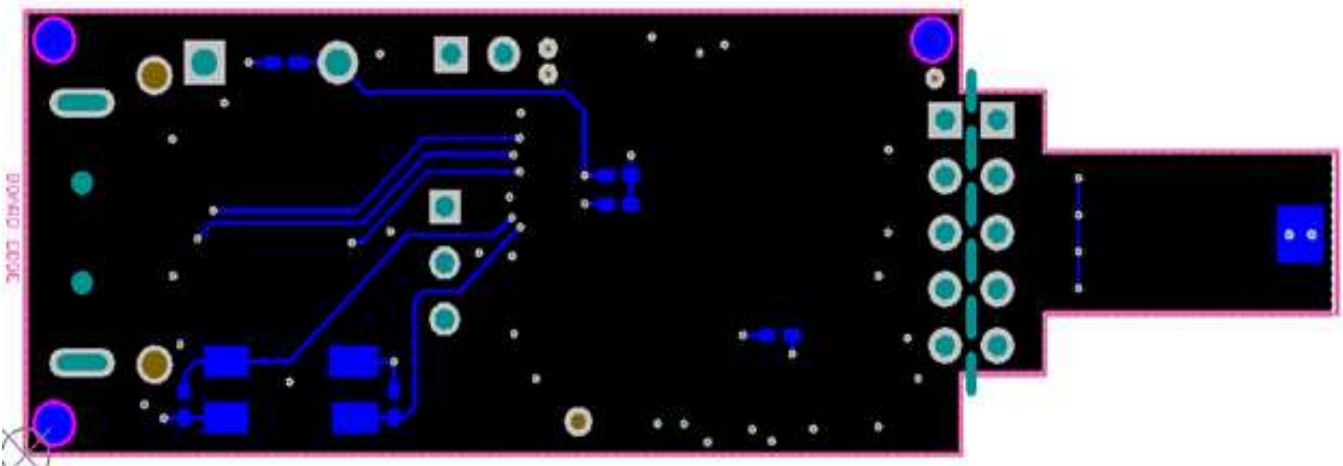
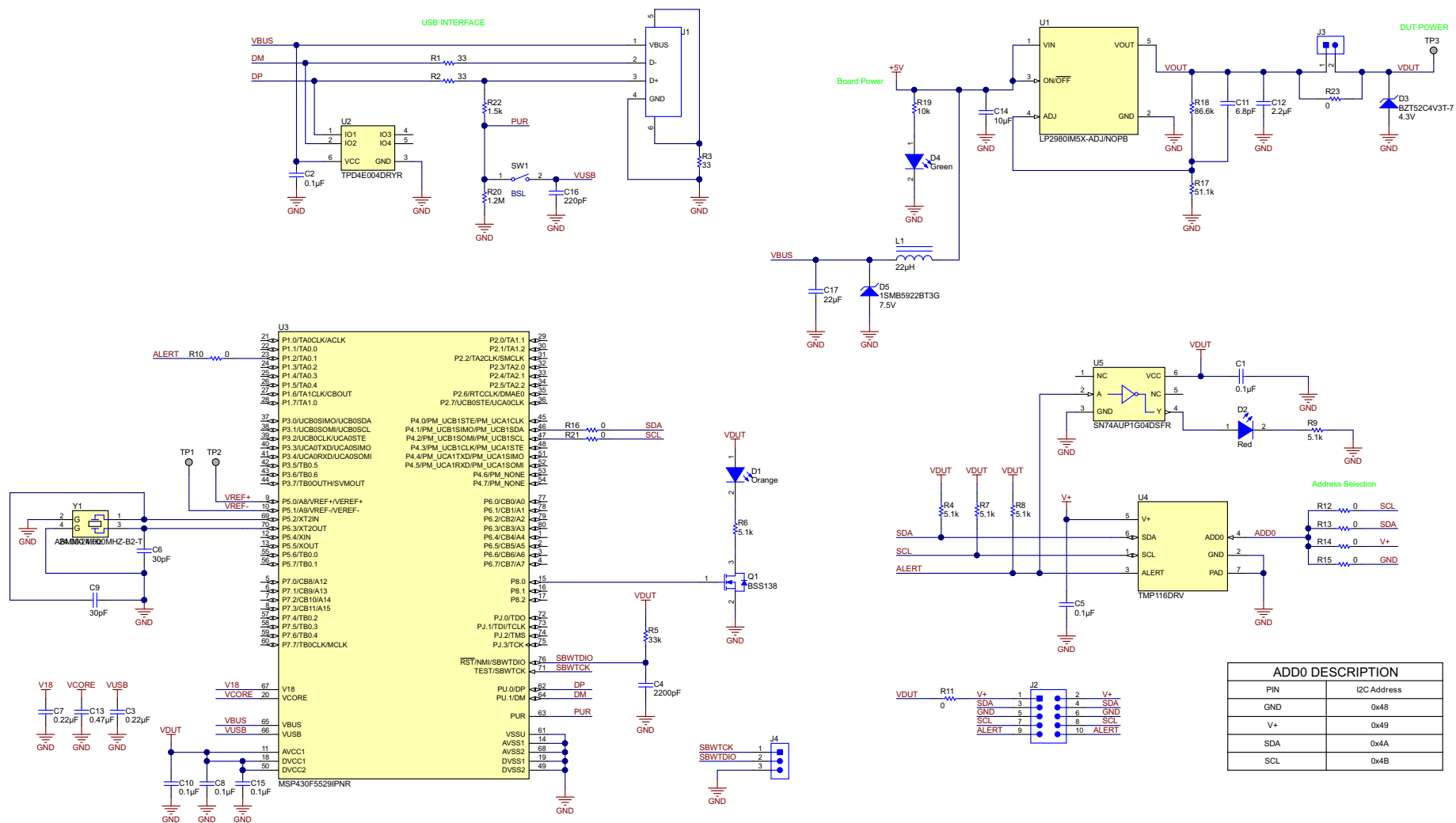

Figure 25. Bottom Layer Routing



Figure 26. Bottom Assembly Layer

## 8 Schematic and Bill of Materials



Copyright © 2017, Texas Instruments Incorporated

Figure 27. TMP116EVM Schematic

Table 4. TMP116EVM Bill of Materials

DESIGNATOR	QTY	VALUE	DESCRIPTION	PACKAGE REFERENCE	PART NUMBER	MANUFACTURER	ALTERNATE PART NUMBER	ALTERNATE MANUFACTURER
!PCB	1		Printed Circuit Board		MHR026	Any	-	-
C1, C8, C10, C15	4	0.1uF	CAP, CERM, 0.1 $\mu$ F, 10 V, +/- 10%, X5R, 0402	0402	C1005X5R1A104K050BA	TDK		
C2	1	0.1uF	CAP, CERM, 0.1 $\mu$ F, 50 V, +/- 10%, X5R, 0402	0402	C1005X5R1H104K050BB	TDK		
C3, C7	2	0.22uF	CAP, CERM, 0.22 $\mu$ F, 16 V, +/- 10%, X5R, 0402	0402	C1005X5R1C224K050BB	TDK		
C4	1	2200pF	CAP, CERM, 2200 pF, 100 V, +/- 10%, X7S, AEC-Q200 Grade 1, 0402	0402	CGA2B3X7S2A222K050B B	TDK		
C5	1	0.1uF	CAP, CERM, 0.1 $\mu$ F, 16 V, +/- 5%, X7R, 0402	0402	GRM155R71C104JA88D	MuRata		
C6, C9	2	30pF	CAP, CERM, 30 pF, 50 V, +/- 5%, C0G/NP0, 0402	0402	GRM1555C1H300JA01D	MuRata		
C11	1	6.8pF	CAP, CERM, 6.8 pF, 25 V, +/- 5%, C0G/NP0, 0402	0402	GRM1555C1E6R8CA01D	MuRata		
C12	1	2.2uF	CAP, CERM, 2.2 $\mu$ F, 16 V, +/- 10%, X5R, 0402	0402	GRM155R61C225KE11D	MuRata		
C13	1	0.47uF	CAP, CERM, 0.47 $\mu$ F, 10 V, +/- 10%, X5R, 0402	0402	GRM155R61A474KE15D	MuRata		
C14	1	10uF	CAP, CERM, 10 $\mu$ F, 10 V, +/- 20%, X5R, 0603	0603	C1608X5R1A106M080AC	TDK		
C16	1	220pF	CAP, CERM, 220 pF, 50 V, +/- 10%, X7R, 0402	0402	GRM155R71H221KA01D	MuRata		
C17	1	22uF	CAP, CERM, 22 $\mu$ F, 10 V, +/- 20%, X5R, 0603	0603	C1608X5R1A226M080AC	TDK		
D1	1	Orange	LED, Orange, SMD	LED_0603	LTST-C191KFKT	Lite-On		
D2	1	Red	LED, Red, SMD	LED_0603	LTST-C191KRKT	Lite-On		
D3	1	4.3V	Diode, Zener, 4.3 V, 300 mW, SOD-523	SOD-523	BZT52C4V3T-7	Diodes Inc.		
D4	1	Green	LED, Green, SMD	LED_0603	LTST-C191TGKT	Lite-On		
D5	1	7.5V	Diode, Zener, 7.5V, 550mW, SMB	SMB	1SMB5922BT3G	ON Semiconductor		
J1	1		Connector, Plug, USB Type A, R/A, Top Mount SMT	Edge mount USB A CONN	0480372200	Molex		
L1	1	22uH	Inductor, Shielded Drum Core, Ferrite, 22 $\mu$ H, 0.7 A, 0.155 ohm, SMD	WE-TPC-M2	744043220	Wurth Elektronik		
Q1	1	50V	MOSFET, N-CH, 50 V, 0.22 A, SOT-23	SOT-23	BSS138	Fairchild Semiconductor		None
R1, R2, R3	3	33	RES, 33, 5%, 0.063 W, 0402	0402	CRCW040233R0JNED	Vishay-Dale		
R4, R6, R7, R8, R9	5	5.1k	RES, 5.1 k, 5%, 0.063 W, 0402	0402	CRCW04025K10JNED	Vishay-Dale		
R5	1	33k	RES, 33 k, 5%, 0.063 W, 0402	0402	CRCW040233K0JNED	Vishay-Dale		

**Table 4. TMP116EVM Bill of Materials (continued)**

DESIGNATOR	QTY	VALUE	DESCRIPTION	PACKAGE REFERENCE	PART NUMBER	MANUFACTURER	ALTERNATE PART NUMBER	ALTERNATE MANUFACTURER
R10, R15, R16, R21, R23	5	0	RES, 0, 5%, 0.063 W, 0402	0402	CRCW04020000Z0ED	Vishay-Dale		
R11	1	0	RES, 0, 5%, 0.1 W, 0603	0603	CRCW06030000Z0EA	Vishay-Dale		
R17	1	51.1k	RES, 51.1 k, 1%, 0.063 W, 0402	0402	CRCW040251K1FKED	Vishay-Dale		
R18	1	86.6k	RES, 86.6 k, 1%, 0.063 W, 0402	0402	CRCW040286K6FKED	Vishay-Dale		
R19	1	10k	RES, 10 k, 5%, 0.1 W, AEC-Q200 Grade 0, 0402	0402	ERJ-2GEJ103X	Panasonic		
R20	1	1.2Meg	RES, 1.2 M, 5%, 0.063 W, 0402	0402	CRCW04021M20JNED	Vishay-Dale		
R22	1	1.5k	RES, 1.5 k, 5%, 0.063 W, 0402	0402	CRCW04021K50JNED	Vishay-Dale		
SW1	1		Switch, Tactile, SPST-NO, 0.05A, 12V, TH	SW, SPST 3.5x5 mm	PTS635SL50 LFS	C and K Components		
U1	1		Micropower 50 mA Ultra Low-Dropout Adjustable Voltage Regulator, DBV0005A	DBV0005A	LP2980IM5X-ADJ/NOPB	Texas Instruments	LP2980IM5-ADJ/NOPB	Texas Instruments
U2	1		ESD-Protection Array for High-Speed Data Interfaces, 4 Channels, -40 to +85 degC, 6-pin SON (DRY), Green (RoHS & no Sb/Br)	DRY0006A	TPD4E004DRYR	Texas Instruments	Equivalent	None
U3	1		25 MHz Mixed Signal Microcontroller with 128 KB Flash, 8192 B SRAM and 63 GPIOs, -40 to 85 degC, 80-pin QFP (PN), Green (RoHS & no Sb/Br)	PN0080A	MSP430F5529IPNR	Texas Instruments	Equivalent	Texas Instruments
U4	1		High-Accuracy, Low-Power, Digital Temperature Sensor with SMBus and Two-Wire Serial Interface, DRV0006A	DRV0006A	TMP116DRV	Texas Instruments		Texas Instruments
U5	1		LOW-POWER SINGLE INVERTER GATE, DSF0006A	DSF0006A	SN74AUP1G04DSFR	Texas Instruments		Texas Instruments
Y1	1		Crystal, 24.000MHz, 18pF, SMD	Xtal, 7.2x1.3x5.2mm	ABMM-24.000MHZ-B2-T	Abracon Corporation		
FID1, FID2, FID3, FID4, FID5, FID6	0		Fiducial mark. There is nothing to buy or mount.	Fiducial	N/A	N/A		
J2	0		Header, 100mil, 5x2, Tin, TH	Header, 5x2, 100mil, Tin	PEC05DAAN	Sullins Connector Solutions		
J3	0		Header, 100mil, 2x1, Gold, TH	2x1 Header	TSW-102-07-G-S	Samtec		
J4	0		Header, 2.54 mm, 3x1, Gold, TH	Header, 2.54 mm, 3x1, TH	GBC03SAAN	Sullins Connector Solutions		
R12, R13, R14	0	0	RES, 0, 5%, 0.063 W, 0402	0402	CRCW04020000Z0ED	Vishay-Dale		
SH-J1	0	1x2	Shunt, 100mil, Gold plated, Black	Shunt	SNT-100-BK-G	Samtec	969102-0000-DA	3M



## Revision History

NOTE: Page numbers for previous revisions may differ from page numbers in the current version.

<b>Changes from Original (June 2017) to A Revision</b>	<b>Page</b>
• Changed figure 17 .....	15
• Changed figure 19 .....	18
• Changed figure 20 .....	19
• Added User Interface.....	19

## STANDARD TERMS FOR EVALUATION MODULES

1. *Delivery:* TI delivers TI evaluation boards, kits, or modules, including any accompanying demonstration software, components, and/or documentation which may be provided together or separately (collectively, an "EVM" or "EVMs") to the User ("User") in accordance with the terms set forth herein. User's acceptance of the EVM is expressly subject to the following terms.
  - 1.1 EVMs are intended solely for product or software developers for use in a research and development setting to facilitate feasibility evaluation, experimentation, or scientific analysis of TI semiconductor products. EVMs have no direct function and are not finished products. EVMs shall not be directly or indirectly assembled as a part or subassembly in any finished product. For clarification, any software or software tools provided with the EVM ("Software") shall not be subject to the terms and conditions set forth herein but rather shall be subject to the applicable terms that accompany such Software
  - 1.2 EVMs are not intended for consumer or household use. EVMs may not be sold, sublicensed, leased, rented, loaned, assigned, or otherwise distributed for commercial purposes by Users, in whole or in part, or used in any finished product or production system.
2. *Limited Warranty and Related Remedies/Disclaimers:*
  - 2.1 These terms do not apply to Software. The warranty, if any, for Software is covered in the applicable Software License Agreement.
  - 2.2 TI warrants that the TI EVM will conform to TI's published specifications for ninety (90) days after the date TI delivers such EVM to User. Notwithstanding the foregoing, TI shall not be liable for a nonconforming EVM if (a) the nonconformity was caused by neglect, misuse or mistreatment by an entity other than TI, including improper installation or testing, or for any EVMs that have been altered or modified in any way by an entity other than TI, (b) the nonconformity resulted from User's design, specifications or instructions for such EVMs or improper system design, or (c) User has not paid on time. Testing and other quality control techniques are used to the extent TI deems necessary. TI does not test all parameters of each EVM. User's claims against TI under this Section 2 are void if User fails to notify TI of any apparent defects in the EVMs within ten (10) business days after delivery, or of any hidden defects with ten (10) business days after the defect has been detected.
  - 2.3 TI's sole liability shall be at its option to repair or replace EVMs that fail to conform to the warranty set forth above, or credit User's account for such EVM. TI's liability under this warranty shall be limited to EVMs that are returned during the warranty period to the address designated by TI and that are determined by TI not to conform to such warranty. If TI elects to repair or replace such EVM, TI shall have a reasonable time to repair such EVM or provide replacements. Repaired EVMs shall be warranted for the remainder of the original warranty period. Replaced EVMs shall be warranted for a new full ninety (90) day warranty period.
3. *Regulatory Notices:*
  - 3.1 *United States*
    - 3.1.1 *Notice applicable to EVMs not FCC-Approved:*

**FCC NOTICE:** This kit is designed to allow product developers to evaluate electronic components, circuitry, or software associated with the kit to determine whether to incorporate such items in a finished product and software developers to write software applications for use with the end product. This kit is not a finished product and when assembled may not be resold or otherwise marketed unless all required FCC equipment authorizations are first obtained. Operation is subject to the condition that this product not cause harmful interference to licensed radio stations and that this product accept harmful interference. Unless the assembled kit is designed to operate under part 15, part 18 or part 95 of this chapter, the operator of the kit must operate under the authority of an FCC license holder or must secure an experimental authorization under part 5 of this chapter.
    - 3.1.2 *For EVMs annotated as FCC – FEDERAL COMMUNICATIONS COMMISSION Part 15 Compliant:*

### CAUTION

This device complies with part 15 of the FCC Rules. Operation is subject to the following two conditions: (1) This device may not cause harmful interference, and (2) this device must accept any interference received, including interference that may cause undesired operation.

Changes or modifications not expressly approved by the party responsible for compliance could void the user's authority to operate the equipment.

### FCC Interference Statement for Class A EVM devices

*NOTE: This equipment has been tested and found to comply with the limits for a Class A digital device, pursuant to part 15 of the FCC Rules. These limits are designed to provide reasonable protection against harmful interference when the equipment is operated in a commercial environment. This equipment generates, uses, and can radiate radio frequency energy and, if not installed and used in accordance with the instruction manual, may cause harmful interference to radio communications. Operation of this equipment in a residential area is likely to cause harmful interference in which case the user will be required to correct the interference at his own expense.*

## FCC Interference Statement for Class B EVM devices

*NOTE: This equipment has been tested and found to comply with the limits for a Class B digital device, pursuant to part 15 of the FCC Rules. These limits are designed to provide reasonable protection against harmful interference in a residential installation. This equipment generates, uses and can radiate radio frequency energy and, if not installed and used in accordance with the instructions, may cause harmful interference to radio communications. However, there is no guarantee that interference will not occur in a particular installation. If this equipment does cause harmful interference to radio or television reception, which can be determined by turning the equipment off and on, the user is encouraged to try to correct the interference by one or more of the following measures:*

- Reorient or relocate the receiving antenna.
- Increase the separation between the equipment and receiver.
- Connect the equipment into an outlet on a circuit different from that to which the receiver is connected.
- Consult the dealer or an experienced radio/TV technician for help.

### 3.2 Canada

3.2.1 For EVMs issued with an Industry Canada Certificate of Conformance to RSS-210 or RSS-247

#### Concerning EVMs Including Radio Transmitters:

This device complies with Industry Canada license-exempt RSSs. Operation is subject to the following two conditions:

(1) this device may not cause interference, and (2) this device must accept any interference, including interference that may cause undesired operation of the device.

#### Concernant les EVMs avec appareils radio:

Le présent appareil est conforme aux CNR d'Industrie Canada applicables aux appareils radio exempts de licence. L'exploitation est autorisée aux deux conditions suivantes: (1) l'appareil ne doit pas produire de brouillage, et (2) l'utilisateur de l'appareil doit accepter tout brouillage radioélectrique subi, même si le brouillage est susceptible d'en compromettre le fonctionnement.

#### Concerning EVMs Including Detachable Antennas:

Under Industry Canada regulations, this radio transmitter may only operate using an antenna of a type and maximum (or lesser) gain approved for the transmitter by Industry Canada. To reduce potential radio interference to other users, the antenna type and its gain should be so chosen that the equivalent isotropically radiated power (e.i.r.p.) is not more than that necessary for successful communication. This radio transmitter has been approved by Industry Canada to operate with the antenna types listed in the user guide with the maximum permissible gain and required antenna impedance for each antenna type indicated. Antenna types not included in this list, having a gain greater than the maximum gain indicated for that type, are strictly prohibited for use with this device.

#### Concernant les EVMs avec antennes détachables

Conformément à la réglementation d'Industrie Canada, le présent émetteur radio peut fonctionner avec une antenne d'un type et d'un gain maximal (ou inférieur) approuvé pour l'émetteur par Industrie Canada. Dans le but de réduire les risques de brouillage radioélectrique à l'intention des autres utilisateurs, il faut choisir le type d'antenne et son gain de sorte que la puissance isotrope rayonnée équivalente (p.i.r.e.) ne dépasse pas l'intensité nécessaire à l'établissement d'une communication satisfaisante. Le présent émetteur radio a été approuvé par Industrie Canada pour fonctionner avec les types d'antenne énumérés dans le manuel d'usage et ayant un gain admissible maximal et l'impédance requise pour chaque type d'antenne. Les types d'antenne non inclus dans cette liste, ou dont le gain est supérieur au gain maximal indiqué, sont strictement interdits pour l'exploitation de l'émetteur.

### 3.3 Japan

3.3.1 *Notice for EVMs delivered in Japan:* Please see [http://www.tij.co.jp/lstds/ti\\_ja/general/eStore/notice\\_01.page](http://www.tij.co.jp/lstds/ti_ja/general/eStore/notice_01.page) 日本国内に輸入される評価用キット、ボードについては、次のところをご覧ください。  
[http://www.tij.co.jp/lstds/ti\\_ja/general/eStore/notice\\_01.page](http://www.tij.co.jp/lstds/ti_ja/general/eStore/notice_01.page)

3.3.2 *Notice for Users of EVMs Considered "Radio Frequency Products" in Japan:* EVMs entering Japan may not be certified by TI as conforming to Technical Regulations of Radio Law of Japan.

If User uses EVMs in Japan, not certified to Technical Regulations of Radio Law of Japan, User is required to follow the instructions set forth by Radio Law of Japan, which includes, but is not limited to, the instructions below with respect to EVMs (which for the avoidance of doubt are stated strictly for convenience and should be verified by User):

1. Use EVMs in a shielded room or any other test facility as defined in the notification #173 issued by Ministry of Internal Affairs and Communications on March 28, 2006, based on Sub-section 1.1 of Article 6 of the Ministry's Rule for Enforcement of Radio Law of Japan,
2. Use EVMs only after User obtains the license of Test Radio Station as provided in Radio Law of Japan with respect to EVMs, or
3. Use of EVMs only after User obtains the Technical Regulations Conformity Certification as provided in Radio Law of Japan with respect to EVMs. Also, do not transfer EVMs, unless User gives the same notice above to the transferee. Please note that if User does not follow the instructions above, User will be subject to penalties of Radio Law of Japan.

【無線電波を送信する製品の開発キットをお使いになる際の注意事項】 開発キットの中には技術基準適合証明を受けていないものがあります。技術適合証明を受けていないものご使用に際しては、電波法遵守のため、以下のいずれかの措置を取っていただく必要がありますのでご注意ください。

1. 電波法施行規則第6条第1項第1号に基づく平成18年3月28日総務省告示第173号で定められた電波暗室等の試験設備でご使用いただく。
2. 実験局の免許を取得後ご使用いただく。
3. 技術基準適合証明を取得後ご使用いただく。

なお、本製品は、上記の「ご使用にあたっての注意」を譲渡先、移転先に通知しない限り、譲渡、移転できないものとします。

上記を遵守頂けない場合は、電波法の罰則が適用される可能性があることをご留意ください。日本テキサス・インスツルメンツ株式会社  
東京都新宿区西新宿 6 丁目 2 4 番 1 号  
西新宿三井ビル

3.3.3 *Notice for EVMs for Power Line Communication:* Please see [http://www.tij.co.jp/llds/ti\\_ja/general/eStore/notice\\_02.page](http://www.tij.co.jp/llds/ti_ja/general/eStore/notice_02.page)  
電力線搬送波通信についての開発キットをお使いになる際の注意事項については、次のところをご覧ください。 [http://www.tij.co.jp/llds/ti\\_ja/general/eStore/notice\\_02.page](http://www.tij.co.jp/llds/ti_ja/general/eStore/notice_02.page)

#### 3.4 *European Union*

##### 3.4.1 *For EVMs subject to EU Directive 2014/30/EU (Electromagnetic Compatibility Directive):*

This is a class A product intended for use in environments other than domestic environments that are connected to a low-voltage power-supply network that supplies buildings used for domestic purposes. In a domestic environment this product may cause radio interference in which case the user may be required to take adequate measures.

#### 4 *EVM Use Restrictions and Warnings:*

4.1 EVMS ARE NOT FOR USE IN FUNCTIONAL SAFETY AND/OR SAFETY CRITICAL EVALUATIONS, INCLUDING BUT NOT LIMITED TO EVALUATIONS OF LIFE SUPPORT APPLICATIONS.

4.2 User must read and apply the user guide and other available documentation provided by TI regarding the EVM prior to handling or using the EVM, including without limitation any warning or restriction notices. The notices contain important safety information related to, for example, temperatures and voltages.

##### 4.3 *Safety-Related Warnings and Restrictions:*

4.3.1 User shall operate the EVM within TI's recommended specifications and environmental considerations stated in the user guide, other available documentation provided by TI, and any other applicable requirements and employ reasonable and customary safeguards. Exceeding the specified performance ratings and specifications (including but not limited to input and output voltage, current, power, and environmental ranges) for the EVM may cause personal injury or death, or property damage. If there are questions concerning performance ratings and specifications, User should contact a TI field representative prior to connecting interface electronics including input power and intended loads. Any loads applied outside of the specified output range may also result in unintended and/or inaccurate operation and/or possible permanent damage to the EVM and/or interface electronics. Please consult the EVM user guide prior to connecting any load to the EVM output. If there is uncertainty as to the load specification, please contact a TI field representative. During normal operation, even with the inputs and outputs kept within the specified allowable ranges, some circuit components may have elevated case temperatures. These components include but are not limited to linear regulators, switching transistors, pass transistors, current sense resistors, and heat sinks, which can be identified using the information in the associated documentation. When working with the EVM, please be aware that the EVM may become very warm.

4.3.2 EVMs are intended solely for use by technically qualified, professional electronics experts who are familiar with the dangers and application risks associated with handling electrical mechanical components, systems, and subsystems. User assumes all responsibility and liability for proper and safe handling and use of the EVM by User or its employees, affiliates, contractors or designees. User assumes all responsibility and liability to ensure that any interfaces (electronic and/or mechanical) between the EVM and any human body are designed with suitable isolation and means to safely limit accessible leakage currents to minimize the risk of electrical shock hazard. User assumes all responsibility and liability for any improper or unsafe handling or use of the EVM by User or its employees, affiliates, contractors or designees.

4.4 User assumes all responsibility and liability to determine whether the EVM is subject to any applicable international, federal, state, or local laws and regulations related to User's handling and use of the EVM and, if applicable, User assumes all responsibility and liability for compliance in all respects with such laws and regulations. User assumes all responsibility and liability for proper disposal and recycling of the EVM consistent with all applicable international, federal, state, and local requirements.

5. *Accuracy of Information:* To the extent TI provides information on the availability and function of EVMs, TI attempts to be as accurate as possible. However, TI does not warrant the accuracy of EVM descriptions, EVM availability or other information on its websites as accurate, complete, reliable, current, or error-free.

6. *Disclaimers:*
- 6.1 EXCEPT AS SET FORTH ABOVE, EVMS AND ANY MATERIALS PROVIDED WITH THE EVM (INCLUDING, BUT NOT LIMITED TO, REFERENCE DESIGNS AND THE DESIGN OF THE EVM ITSELF) ARE PROVIDED "AS IS" AND "WITH ALL FAULTS." TI DISCLAIMS ALL OTHER WARRANTIES, EXPRESS OR IMPLIED, REGARDING SUCH ITEMS, INCLUDING BUT NOT LIMITED TO ANY EPIDEMIC FAILURE WARRANTY OR IMPLIED WARRANTIES OF MERCHANTABILITY OR FITNESS FOR A PARTICULAR PURPOSE OR NON-INFRINGEMENT OF ANY THIRD PARTY PATENTS, COPYRIGHTS, TRADE SECRETS OR OTHER INTELLECTUAL PROPERTY RIGHTS.
- 6.2 EXCEPT FOR THE LIMITED RIGHT TO USE THE EVM SET FORTH HEREIN, NOTHING IN THESE TERMS SHALL BE CONSTRUED AS GRANTING OR CONFERRING ANY RIGHTS BY LICENSE, PATENT, OR ANY OTHER INDUSTRIAL OR INTELLECTUAL PROPERTY RIGHT OF TI, ITS SUPPLIERS/LICENSORS OR ANY OTHER THIRD PARTY, TO USE THE EVM IN ANY FINISHED END-USER OR READY-TO-USE FINAL PRODUCT, OR FOR ANY INVENTION, DISCOVERY OR IMPROVEMENT, REGARDLESS OF WHEN MADE, CONCEIVED OR ACQUIRED.
7. *USER'S INDEMNITY OBLIGATIONS AND REPRESENTATIONS.* USER WILL DEFEND, INDEMNIFY AND HOLD TI, ITS LICENSORS AND THEIR REPRESENTATIVES HARMLESS FROM AND AGAINST ANY AND ALL CLAIMS, DAMAGES, LOSSES, EXPENSES, COSTS AND LIABILITIES (COLLECTIVELY, "CLAIMS") ARISING OUT OF OR IN CONNECTION WITH ANY HANDLING OR USE OF THE EVM THAT IS NOT IN ACCORDANCE WITH THESE TERMS. THIS OBLIGATION SHALL APPLY WHETHER CLAIMS ARISE UNDER STATUTE, REGULATION, OR THE LAW OF TORT, CONTRACT OR ANY OTHER LEGAL THEORY, AND EVEN IF THE EVM FAILS TO PERFORM AS DESCRIBED OR EXPECTED.
8. *Limitations on Damages and Liability:*
- 8.1 *General Limitations.* IN NO EVENT SHALL TI BE LIABLE FOR ANY SPECIAL, COLLATERAL, INDIRECT, PUNITIVE, INCIDENTAL, CONSEQUENTIAL, OR EXEMPLARY DAMAGES IN CONNECTION WITH OR ARISING OUT OF THESE TERMS OR THE USE OF THE EVMS , REGARDLESS OF WHETHER TI HAS BEEN ADVISED OF THE POSSIBILITY OF SUCH DAMAGES. EXCLUDED DAMAGES INCLUDE, BUT ARE NOT LIMITED TO, COST OF REMOVAL OR REINSTALLATION, ANCILLARY COSTS TO THE PROCUREMENT OF SUBSTITUTE GOODS OR SERVICES, RETESTING, OUTSIDE COMPUTER TIME, LABOR COSTS, LOSS OF GOODWILL, LOSS OF PROFITS, LOSS OF SAVINGS, LOSS OF USE, LOSS OF DATA, OR BUSINESS INTERRUPTION. NO CLAIM, SUIT OR ACTION SHALL BE BROUGHT AGAINST TI MORE THAN TWELVE (12) MONTHS AFTER THE EVENT THAT GAVE RISE TO THE CAUSE OF ACTION HAS OCCURRED.
- 8.2 *Specific Limitations.* IN NO EVENT SHALL TI'S AGGREGATE LIABILITY FROM ANY USE OF AN EVM PROVIDED HEREUNDER, INCLUDING FROM ANY WARRANTY, INDEMNITY OR OTHER OBLIGATION ARISING OUT OF OR IN CONNECTION WITH THESE TERMS, , EXCEED THE TOTAL AMOUNT PAID TO TI BY USER FOR THE PARTICULAR EVM(S) AT ISSUE DURING THE PRIOR TWELVE (12) MONTHS WITH RESPECT TO WHICH LOSSES OR DAMAGES ARE CLAIMED. THE EXISTENCE OF MORE THAN ONE CLAIM SHALL NOT ENLARGE OR EXTEND THIS LIMIT.
9. *Return Policy.* Except as otherwise provided, TI does not offer any refunds, returns, or exchanges. Furthermore, no return of EVM(s) will be accepted if the package has been opened and no return of the EVM(s) will be accepted if they are damaged or otherwise not in a resalable condition. If User feels it has been incorrectly charged for the EVM(s) it ordered or that delivery violates the applicable order, User should contact TI. All refunds will be made in full within thirty (30) working days from the return of the components(s), excluding any postage or packaging costs.
10. *Governing Law:* These terms and conditions shall be governed by and interpreted in accordance with the laws of the State of Texas, without reference to conflict-of-laws principles. User agrees that non-exclusive jurisdiction for any dispute arising out of or relating to these terms and conditions lies within courts located in the State of Texas and consents to venue in Dallas County, Texas. Notwithstanding the foregoing, any judgment may be enforced in any United States or foreign court, and TI may seek injunctive relief in any United States or foreign court.

## IMPORTANT NOTICE FOR TI DESIGN INFORMATION AND RESOURCES

Texas Instruments Incorporated ("TI") technical, application or other design advice, services or information, including, but not limited to, reference designs and materials relating to evaluation modules, (collectively, "TI Resources") are intended to assist designers who are developing applications that incorporate TI products; by downloading, accessing or using any particular TI Resource in any way, you (individually or, if you are acting on behalf of a company, your company) agree to use it solely for this purpose and subject to the terms of this Notice.

TI's provision of TI Resources does not expand or otherwise alter TI's applicable published warranties or warranty disclaimers for TI products, and no additional obligations or liabilities arise from TI providing such TI Resources. TI reserves the right to make corrections, enhancements, improvements and other changes to its TI Resources.

You understand and agree that you remain responsible for using your independent analysis, evaluation and judgment in designing your applications and that you have full and exclusive responsibility to assure the safety of your applications and compliance of your applications (and of all TI products used in or for your applications) with all applicable regulations, laws and other applicable requirements. You represent that, with respect to your applications, you have all the necessary expertise to create and implement safeguards that (1) anticipate dangerous consequences of failures, (2) monitor failures and their consequences, and (3) lessen the likelihood of failures that might cause harm and take appropriate actions. You agree that prior to using or distributing any applications that include TI products, you will thoroughly test such applications and the functionality of such TI products as used in such applications. TI has not conducted any testing other than that specifically described in the published documentation for a particular TI Resource.

You are authorized to use, copy and modify any individual TI Resource only in connection with the development of applications that include the TI product(s) identified in such TI Resource. NO OTHER LICENSE, EXPRESS OR IMPLIED, BY ESTOPPEL OR OTHERWISE TO ANY OTHER TI INTELLECTUAL PROPERTY RIGHT, AND NO LICENSE TO ANY TECHNOLOGY OR INTELLECTUAL PROPERTY RIGHT OF TI OR ANY THIRD PARTY IS GRANTED HEREIN, including but not limited to any patent right, copyright, mask work right, or other intellectual property right relating to any combination, machine, or process in which TI products or services are used. Information regarding or referencing third-party products or services does not constitute a license to use such products or services, or a warranty or endorsement thereof. Use of TI Resources may require a license from a third party under the patents or other intellectual property of the third party, or a license from TI under the patents or other intellectual property of TI.

TI RESOURCES ARE PROVIDED "AS IS" AND WITH ALL FAULTS. TI DISCLAIMS ALL OTHER WARRANTIES OR REPRESENTATIONS, EXPRESS OR IMPLIED, REGARDING TI RESOURCES OR USE THEREOF, INCLUDING BUT NOT LIMITED TO ACCURACY OR COMPLETENESS, TITLE, ANY EPIDEMIC FAILURE WARRANTY AND ANY IMPLIED WARRANTIES OF MERCHANTABILITY, FITNESS FOR A PARTICULAR PURPOSE, AND NON-INFRINGEMENT OF ANY THIRD PARTY INTELLECTUAL PROPERTY RIGHTS.

TI SHALL NOT BE LIABLE FOR AND SHALL NOT DEFEND OR INDEMNIFY YOU AGAINST ANY CLAIM, INCLUDING BUT NOT LIMITED TO ANY INFRINGEMENT CLAIM THAT RELATES TO OR IS BASED ON ANY COMBINATION OF PRODUCTS EVEN IF DESCRIBED IN TI RESOURCES OR OTHERWISE. IN NO EVENT SHALL TI BE LIABLE FOR ANY ACTUAL, DIRECT, SPECIAL, COLLATERAL, INDIRECT, PUNITIVE, INCIDENTAL, CONSEQUENTIAL OR EXEMPLARY DAMAGES IN CONNECTION WITH OR ARISING OUT OF TI RESOURCES OR USE THEREOF, AND REGARDLESS OF WHETHER TI HAS BEEN ADVISED OF THE POSSIBILITY OF SUCH DAMAGES.

You agree to fully indemnify TI and its representatives against any damages, costs, losses, and/or liabilities arising out of your non-compliance with the terms and provisions of this Notice.

This Notice applies to TI Resources. Additional terms apply to the use and purchase of certain types of materials, TI products and services. These include; without limitation, TI's standard terms for semiconductor products (<http://www.ti.com/sc/docs/stdterms.htm>), [evaluation modules](#), and [samples](http://www.ti.com/sc/docs/sampterm.htm) (<http://www.ti.com/sc/docs/sampterm.htm>).

Mailing Address: Texas Instruments, Post Office Box 655303, Dallas, Texas 75265  
Copyright © 2017, Texas Instruments Incorporated