

Peak Emission Wavelength: 1300nm

The MTE1300N5 consists of a 1300nm high output infrared die in a water-clear 5mm plastic molded dome shaped package. Custom package solutions and sorting are available.

FEATURES

- > High Output Power
- > Narrow Beam Angle
- > High Reliability

APPLICATIONS

- > Optical Switches & Sensors
- > Fiber Optical Communication
- > Bar-code Reader

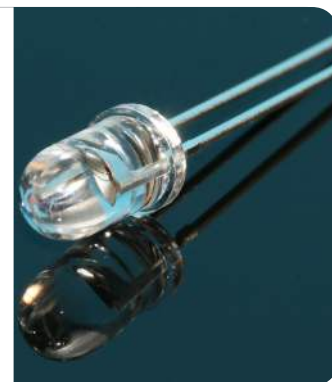

Absolute Maximum Ratings (Ta=25°C)



ITEMS	SYMBOL	RATINGS	UNIT
Forward Current (DC)	IF	100	mA
Forward Current (Pulse)*1	IFP	1	A
Reverse Voltage	VR	5	V
Power Dissipation	PD	120	mW
Operating Temperature Range	Topr	-20 ~ +80	°C
Storage Temperature Range	Tstg	-30 ~ +100	°C
Junction Temperature	Tj	100	°C
Lead Soldering Temperature*2	Tls	260	°C

*1: Tw=10μsec, T=10msec. *2: Time 5Sec max, Position: Up to 3mm from the body.

Electrical & Optical Characteristics (Ta = 25°C)

ITEMS	SYMBOL	CONDITIONS	MIN	TYP	MAX	UNIT
Power Output	PO	IF=20mA	--	7.0	--	mW
Power Output	PO	IF=50mA	--	13.5	--	mW
Forward Voltage	VF	IF=20mA	--	0.95	--	V
Forward Voltage	VF	IF=50mA	--	1.05	--	V
Reverse Current	IR	VR=5V	--	--	100	μA
Peak Emission Wavelength	λp	IF=50mA	--	1300	--	nm
Spectral Line Half Width	Δλ	IF=50mA	--	70	--	nm
Half Intensity Beam Angle	Θ	IF=50mA	--	±5	--	deg

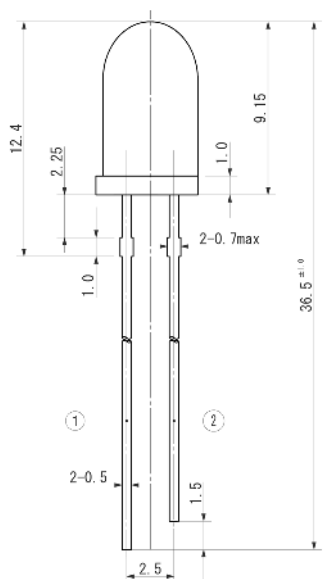

SPECTRAL OUTPUT

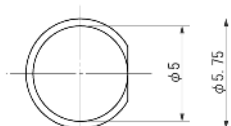
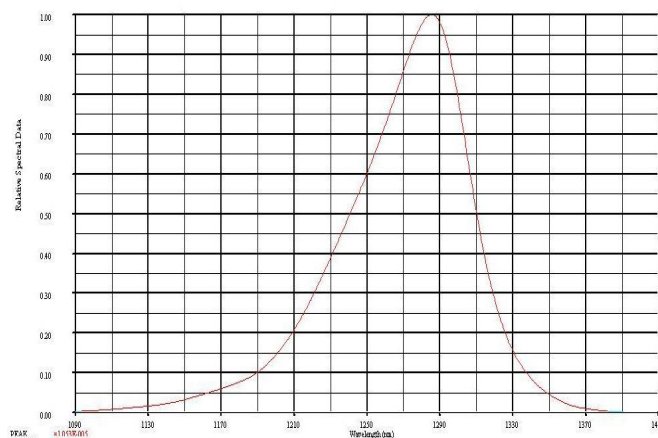

Forward I-V Characteristics

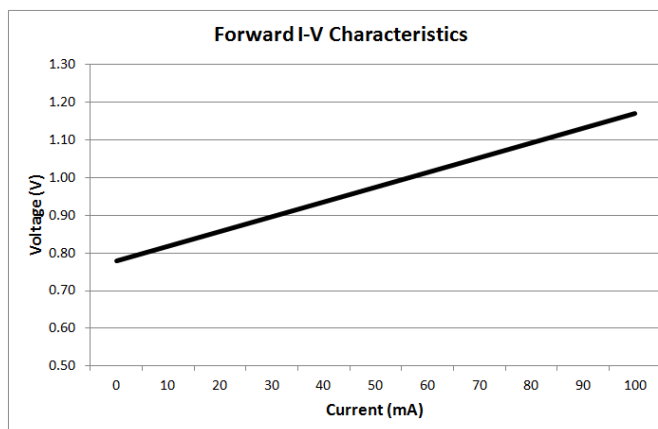

Unit: mm, Tolerance: ±0.2

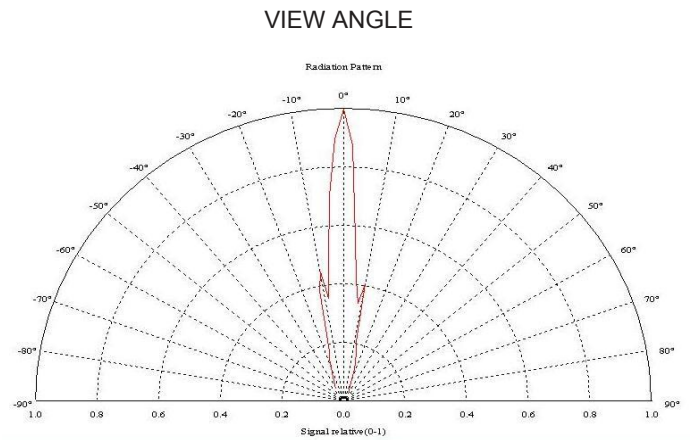
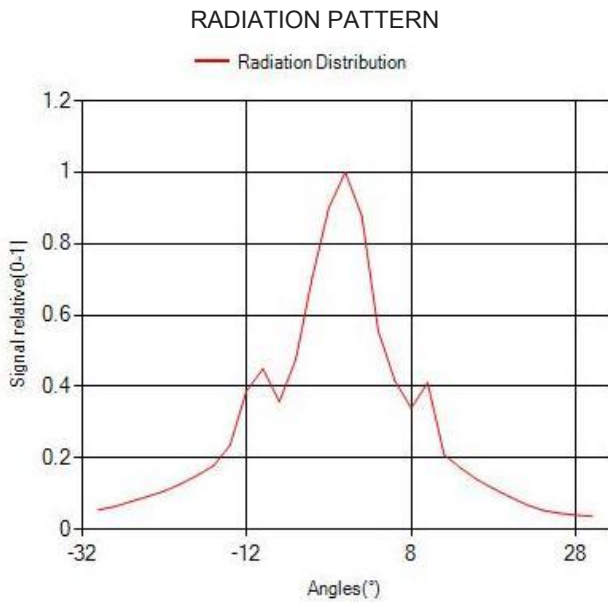
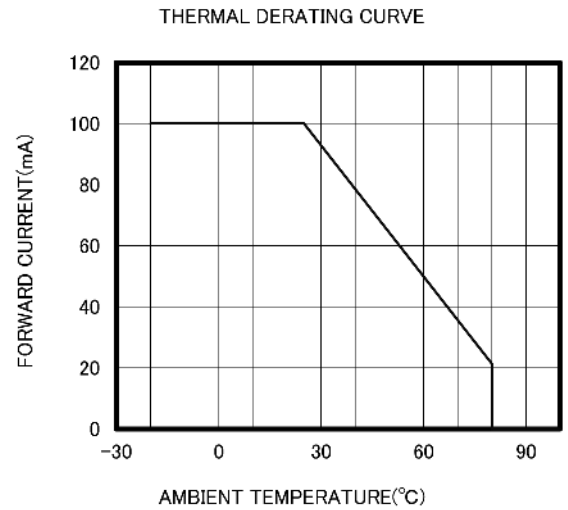
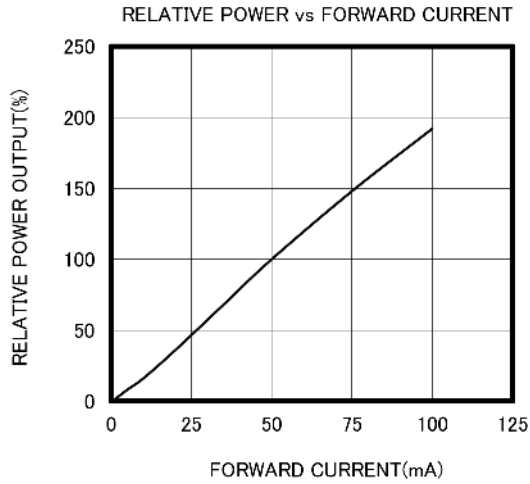

The information contained herein is subject to change without notice.

2019-06-18