1A PWM/VFM Dual Step-down DC/DC Converter with Synchronous Rectifier

No.EA-285-210909

OUTLINE

The RP550K001A is a CMOS-based 1A*¹ dual step-down DC/DC converter with synchronous rectifier. Internally, a single converter consists of oscillators, reference voltage units, error amplifiers, switching control circuits, soft-start circuit, latch type protection circuit, an under voltage lockout (UVLO) circuit, a thermal shutdown circuit and switching transistors.

Replacing diodes with built-in switching transistors improves the efficiency of rectification. Therefore, by simply using two inductors, resistors and capacitors as the external components, a low ripple high efficiency synchronous rectifier step-down DC/DC converter can be easily configured.

Latch type protection circuit latches the built-in driver to the OFF state during high load or if the output is short-circuited for a specified time (protection delay time). The latch protection circuit can be released by once setting the converter into the standby mode with the CE pin and then setting it back to the active mode, or, by turning the power off and back on. Setting the supply voltage lower than the UVLO detector threshold can also release the latch protection circuit. Thermal shutdown circuit detects overheating of the converter and stops the converter operation to protect it from damage if the junction temperature exceeds the specified temperature.

By inputting a signal to the MODE pin, the RP550K001A can choose PWM/VFM auto switching control or forced PWM control. In low output current, PWM/VFM auto switching control automatically switches from PWM mode to VFM mode in order to achieve high efficiency. Likewise, in low output current, forced PWM control switches at fixed frequency in order to reduce noise.

When the both converters are in PWM control, the converters operate with 180° turn-on phase shift of the switching transistors.

The RP550K001A is available in DFN(PL)2730-12 package which achieves high-density mounting on boards.

*¹ This is an approximate value, because output current depends on conditions and external components.

FEATURES

- Supply Current Typ. 45μA (VFM mode with no load/ 1 channel)
- Standby Current..... Max. 10μA
- Input Voltage Range 2.3V to 5.5V ($V_{SET} \geq 0.8V$)
- Output Voltage Range Adjustable from 0.6V (Recommended range is up to 3.3V)
- Feedback Voltage Accuracy..... ±9mV ($V_{FB}=0.6V$)
- Output Voltage Temperature Coefficient ±100ppm/°C
- Oscillator Frequency Typ. 2.25MHz
- Oscillator Maximum Duty Min. 100%
- Built-in Driver ON Resistance..... Typ. Pch. 0.25Ω, Nch. 0.21Ω ($V_{IN}=3.6V$)
- UVLO Detector Threshold Typ. 2.0V
- Soft Start Time..... Typ. 0.2ms
- Lx Current Limit Circuit Typ. 1700mA/ channel
- Latch Type Protection Circuit Typ. 1.5ms
- Package DFN(PL)2730-12

APPLICATION

- Power source for battery-powered equipment
- Power source for hand-held communication equipment, cameras, and VCRs
- Power source for Wireless LAN terminals

BLOCK DIAGRAM

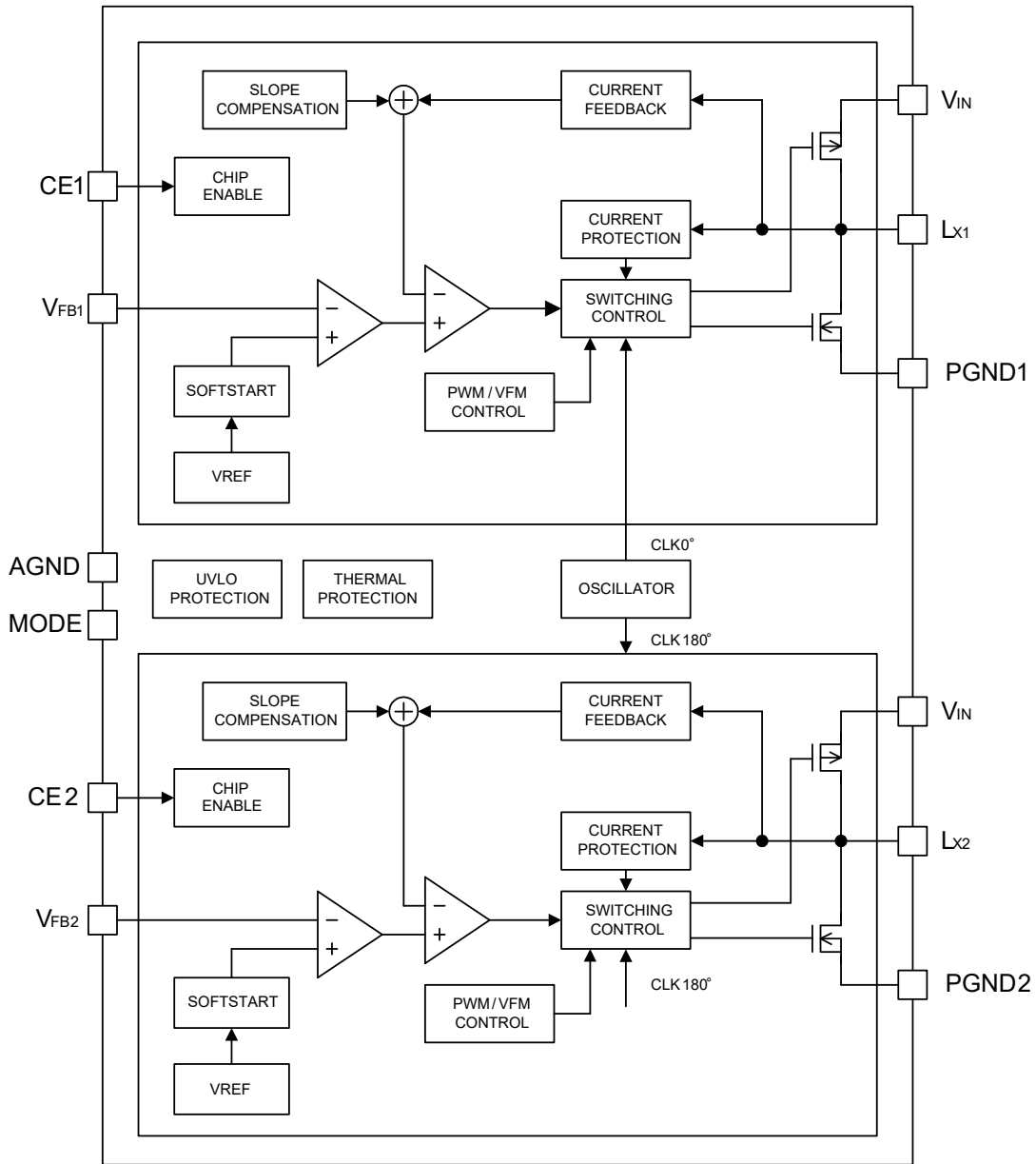

Figure 1. RP550K001A

SELECTION GUIDE

Product Name	Package	Quantity per Reel	Pb Free	Halogen Free
RP550K001A-TR	DFN(PL)2730-12	5,000pcs	Yes	Yes
Output voltage is adjustable with external divider resistors. Recommended output voltage range is from 0.6V to 3.3V.				

PIN CONFIGURATIONS

• DFN(PL)-2730-12

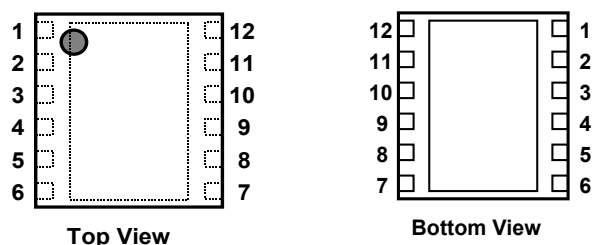

PIN DESCRIPTIONS

RP550K001A: DFN(PL)2730-12

Pin No.	Symbol	Description
1	V_{FB2}	Channel 2 Feedback Pin
2	MODE	Mode Control Pin ("H" forced PWM control, "L" PWM/VFM auto switching control)
3	V_{IN}	Input Pin ^{*2}
4	V_{IN}	Input Pin ^{*2}
5	AGND	Analog Ground Pin ^{*3}
6	V_{FB1}	Channel 1 Feedback Pin
7	CE1	Channel 1 Chip Enable Pin ("H" active)
8	L_{X1}	Channel 1 Lx Switching Pin
9	PGND1	Channel 1 Power Ground Pin ^{*3}
10	PGND2	Channel 2 Power Ground Pin ^{*3}
11	L_{X2}	Channel 2 Lx Switching Pin
12	CE2	Channel 2 Chip Enable Pin ("H" active)

The exposed tab on the bottom of the package enhances thermal performance and is electrically connected to GND (substrate level). It is recommended that the exposed tab be connected to the ground plane on the board or otherwise be left open.

^{*2} No.3 pin and No.4 pin must be wired to the V_{IN} plane when mounting on boards.

^{*3} No.5 pin, No.9 pin and No.10 pin must be wired to the GND plane when mounting on boards.

ABSOLUTE MAXIMUM RATINGS

(AGND=PGND1=PGND2=0V)

Symbol	Item	Rating	Unit
V _{IN}	V _{IN} Input Pin Voltage	-0.3 to 6.5	V
V _{LX1} , V _{LX2}	L _{X1} , L _{X2} Pin Voltage	-0.3 to V _{IN} + 0.3	V
V _{CE1} , V _{CE2}	CE1, CE2 Pin Voltage	-0.3 to 6.5	V
V _{MODE}	MODE Pin Voltage	-0.3 to 6.5	V
V _{FB1} , V _{FB2}	V _{FB1} , V _{FB2} Pin Voltage	-0.3 to 6.5	V
I _{LX1} , I _{LX2}	L _{X1} , L _{X2} Pin Output Current	1.7	A
P _D	Power Dissipation* ⁴	Standard Land Pattern* ⁴	1000
		High Wattage Land Pattern* ⁴	1950
T _a	Operating Temperature Range	-40 to +85	°C
T _{stg}	Storage Temperature Range	-55 to +125	°C

*⁴ For more information about Power Dissipation, Standard Land Pattern and High Wattage Land Pattern, please refer to *PACKAGE INFORMATION*.

ABSOLUTE MAXIMUM RATINGS

Electronic and mechanical stress momentarily exceeded absolute maximum ratings may cause the permanent damages and may degrade the lifetime and safety for both device and system using the device in the field. The functional operation at or over these absolute maximum ratings is not assured.

RECOMMENDED OPERATING CONDITIONS (ELECTRICAL CHARACTERISTICS)

All of electronic equipment should be designed that the mounted semiconductor devices operate within the recommended operating conditions. The semiconductor devices cannot operate normally over the recommended operating conditions, even if when they are used over such conditions by momentary electronic noise or surge. And the semiconductor devices may receive serious damage when they continue to operate over the recommended operating conditions.

ELECTRICAL CHARACTERISTICS

Test Circuit is "OPEN LOOP" and Test Condition is AGND=PGND1=PGND2=0V, unless otherwise noted.

RP550K001A

(Ta=25°C)

Symbol	Item	Conditions	Min.	Typ.	Max.	Unit
V _{IN}	Operating Input Voltage	0.8V ≤ V _{SET} *6	2.3		5.5	V
		0.6V ≤ V _{SET} < 0.8V	2.3		4.5	
V _{FB}	Feedback Voltage	V _{IN} =V _{CE1} =V _{CE2} =3.6V	0.591	0.600	0.609	V
ΔV _{FB} /ΔTa	Output Voltage Temperature Coefficient	-40°C ≤ Ta ≤ 85°C		±100		ppm/°C
fosc	Oscillator Frequency	V _{IN} =V _{CE1} =V _{CE2} =3.6V	2.00	2.25	2.50	MHz
I _{DD1}	Supply Current 1*5	V _{IN} =V _{CE1} =V _{CE2} =5.5V, V _{FB1} =V _{FB2} =0.45V, V _{MODE} =0V		800	1100	μA
I _{DD2}	Supply Current 2*5	V _{IN} =V _{CE1} =V _{CE2} =5.5V, V _{FB1} =V _{FB2} =0.75V, V _{MODE} =0V		45	60	μA
I _{DD3}	Supply Current 3*5	V _{IN} =V _{CE1} =V _{CE2} =5.5V, V _{FB1} =V _{FB2} =0.75V, V _{MODE} =5.5V		800	1100	μA
I _{standby}	Standby Current *5	V _{IN} =5.5V, V _{CE1} =V _{CE2} =0V		0	10	μA
I _{CEH}	CE "H" Input Current*5	V _{IN} =5.5V, V _{CE1} =V _{CE2} =5.5V	-1	0	1	μA
I _{CEL}	CE "L" Input Current*5	V _{IN} =5.5V, V _{CE1} =V _{CE2} =0V	-1	0	1	μA
I _{MODEH}	MODE "H" Input Current	V _{IN} =V _{MODE} =5.5V	-1	0	1	μA
I _{MODEL}	MODE "L" Input Current	V _{IN} =5.5V, V _{MODE} =0V	-1	0	1	μA
I _{FBH}	V _{FB} "H" Input Current *5	V _{IN} =V _{FB1} =V _{FB2} =5.5V, V _{CE1} =V _{CE2} =0V	-1	0	1	μA
I _{FBL}	V _{FB} "L" Input Current*5	V _{IN} =5.5V, V _{CE1} =V _{CE2} =V _{FB1} =V _{FB2} =0V	-1	0	1	μA
I _{LXLEAKH}	Lx Leakage Current "H"*5	V _{IN} =V _{LX1} =V _{LX2} =5.5V, V _{CE1} =V _{CE2} =0V	-1	0	5	μA
I _{LXLEAKL}	Lx Leakage Current "L"*5	V _{IN} =5.5V, V _{CE1} =V _{CE2} =V _{LX1} =V _{LX2} =0V	-5	0	1	μA
V _{CEH}	CE "H" Input Voltage	V _{IN} =5.5V	1.0			V
V _{CEL}	CE "L" Input Voltage	V _{IN} =2.3V			0.4	V
V _{MODEH}	MODE "H" Input Voltage	V _{IN} =5.5V	1.0			V
V _{MODEL}	MODE "L" Input Voltage	V _{IN} =2.3V			0.4	V
R _{ONP}	Pch Transistor ON Resistance	V _{IN} =3.6V, I _{LX1} =I _{LX2} =-100mA		0.25		Ω
R _{ONN}	Nch Transistor ON Resistance	V _{IN} =3.6V, I _{LX1} =I _{LX2} =-100mA		0.21		Ω
Maxduty	Oscillator Maximum Duty Cycle		100			%
tstart	Soft-start Time	V _{IN} =V _{CE1} =V _{CE2} =3.6V		200	300	μs
I _{LXLIM}	Lx Limit Current	V _{IN} =V _{CE1} =V _{CE2} =3.6V	1400	1700		mA
tprot	Protection Delay Time	V _{IN} =V _{CE1} =V _{CE2} =3.6V	0.5	1.5	5	ms
V _{UVLO1}	UVLO Detector Threshold	V _{IN} =V _{CE1} =V _{CE2}	1.9	2.0	2.1	V
V _{UVLO2}	UVLO Released Voltage	V _{IN} =V _{CE1} =V _{CE2}	2.0	2.1	2.2	V

RP550K001A

Symbol	Item	Conditions	Min.	Typ.	Max.	Unit
T _{TSD}	Thermal Shutdown Temperature	Junction Temperature		140		°C
T _{TSR}	Thermal Shutdown Released Temperature	Junction Temperature		100		°C

All test items listed under *Electrical Characteristics* (P.5, P.6) are done under the pulse load condition ($T_j \approx T_a = 25^\circ\text{C}$) except Output Voltage Temperature Coefficient and Oscillator Maximum Duty Cycle.

^{*5} For Standby Current, the sum of Channel 1 and Channel 2 is indicated.

As for the following currents, either Channel 1 value or Channel 2 value is indicated.

- Supply Current 1 to Supply Current 3
- CE "H" Input Current
- CE "L" Input Current
- V_{FB} "H" Input Current
- V_{FB} "L" Input Current
- L_X Leakage Current "H"
- L_X Leakage Current "L"

^{*6} V_{SET}= Set Output Voltage

TYPICAL APPLICATION

Figure 2. RP550K001A

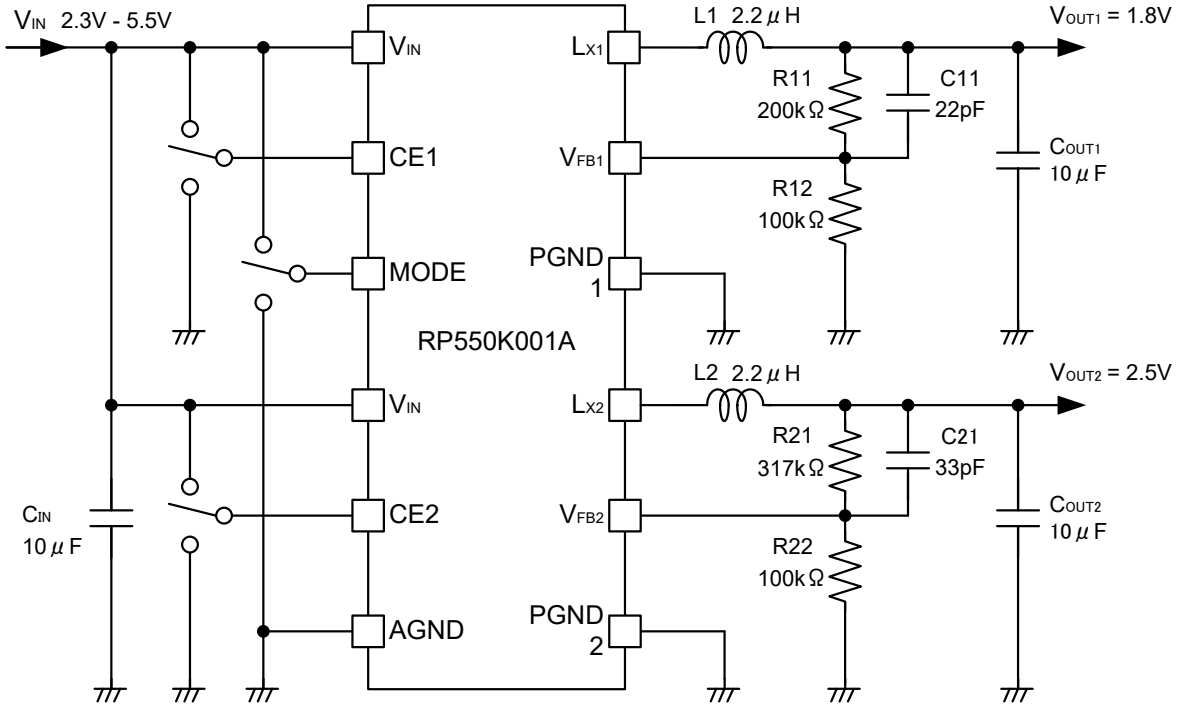

Note: MODE="H" forced PWM control
 MODE="L" PWM/VFM auto switching control

Table 1. Recommended Components: $0.8V \leq V_{SET} \leq 3.3V$

Symbol	Value	Components	Part Number
C_{IN}	10 μF	Ceramic Capacitor	C1608JB0J106M(TDK)
C_{OUT}	10 μF	Ceramic Capacitor	C1608JB0J106M(TDK)
L	2.2 μH	Inductor	MIPSA2520D2R2(FDK)

Table 2. Recommended Components: $0.6V \leq V_{SET} < 0.8V$

Symbol	Value	Components	Part Number
C_{IN}	10 μF	Ceramic Capacitor	C1608JB0J106M(TDK)
C_{OUT}	10 μF x 2	Ceramic Capacitor	C1608JB0J106M(TDK)
L	1.5 μH	Inductor	MIPSA2520D1R5(FDK)

TECHNICAL NOTES

When using the RP550K001A, please consider the following points.

- AGND, PGND1 and PGND2 must be wired to the GND plane when mounting on boards.
- The V_{IN} pins must be wired to the V_{IN} plane when mounting on boards
- Ensure the V_{IN} and GND lines are sufficiently robust. A large switching current flows through the GND line, the V_{DD} line, the V_{OUT} line, an inductor, and L_X. If their impedance is too high, noise pickup or unstable operation may result. Set external components as close as possible to the IC and minimize the wiring between the components and the IC, especially between a capacitor and the V_{IN} pin. The wiring between V_{FB} and load and between L and V_{OUT} should be separated.
- Choose a low ESR ceramic capacitor. The ceramic capacitance of a capacitor (C_{IN}) connected between V_{IN} and GND should be more than or equal to 10μF. The ceramic capacitance of a capacitor (C_{OUT}) connected between V_{OUT} and GND should be 10μF to 20μF. Please be aware of the characteristics of bias dependence and temperature fluctuation of ceramic capacitor.
- The phase compensation of this IC is designed according to the above C_{OUT} values and L values. For stable operation, a ceramic capacitance value and an inductance value have to be selected within these values. Choose an inductor that has small DC resistance, has enough allowable current and is hard to cause magnetic saturation. If the inductance value of an inductor is extremely small, the peak current of L_X may increase along with the load current. As a result, over current protection circuit may start to operate when the peak current of L_X reaches to “L_X limit current”.
- Over current protection circuit and latch type protection circuit may be affected by self-heating or power dissipation environment.
- The output voltages (V_{OUT1}, V_{OUT2}) are adjustable by changing the values of R11, R12, R21, and R22 as follows.

$$V_{OUT1} = 0.6 \times (R11 + R12) / R12 \quad (\text{Recommended range: } 0.6V \leq V_{OUT1} \leq 3.3V)$$

$$V_{OUT2} = 0.6 \times (R21 + R22) / R22 \quad (\text{Recommended range: } 0.6V \leq V_{OUT2} \leq 3.3V)$$

- If R11, R12, R21, and R22 are too large, the impedances of V_{FB1} and V_{FB2} also become large, as a result, the IC could be easily affected by noise. For this reason, R12 and R22 should be 100kΩ or less. If the operation becomes unstable due to the high impedances, the impedances should be decreased.
- C11 and C21 can be calculated by the following equations. Please use the value close to the calculation result.

$$C11 = 2.2 \times 10^{-6} / R12 \text{ [F]} \quad (0.6V \leq V_{OUT1} \leq 3.3V)$$

$$C21 = 2.2 \times 10^{-6} / R22 \text{ [F]} \quad (0.6V \leq V_{OUT2} \leq 3.3V)$$

- The recommended resistance values for R11, R12, R21, R22, C11, and C21 are as follows.

Table 3. Recommended Resistor and Capacitor Values

Output Voltage V _{OUT1} , V _{OUT2} [V]	Resistor [kΩ]		Capacitor [pF]
	R11, R21	R12, R22	C11, C21
0.6	0	100	-
0.7	16.7	100	22
0.8	33.3	100	22
1.2	100	100	22
1.8	200	100	22
2.5	317	100	22
3.3	450	100	22

- ★ The performance of power source circuits using this IC largely depends on the peripheral circuits. When selecting the peripheral components, please consider the conditions of use. Do not allow each component, PCB pattern and the IC to exceed their respected rated values (voltage, current, and power) when designing the peripheral circuits.

OPERATION OF STEP-DOWN DC/DC CONVERTER AND OUTPUT CURRENT

The step-down DC/DC converter charges energy in the inductor when L_X Tr. turns "ON", and discharges the energy from the inductor when L_X Tr. turns "OFF" and controls with less energy loss, so that a lower output voltage (V_{OUT}) than the input voltage (V_{IN}) can be obtained. The operation of the step-down DC/DC converter is explained in the following figures.

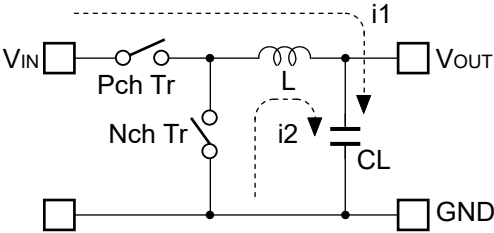

Figure 3. Basic Circuit

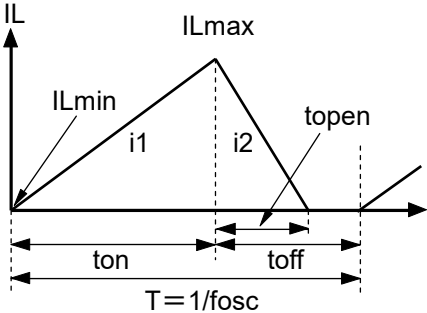

Figure 4. Inductor Current (IL) flowing through Inductor

- Step 1:** Pch Tr. is "ON" and current $IL=i1$ flows, and energy is charged into CL. At this moment, in proportion to the time while Pch Tr. is "ON" (t_{ON}), $IL=i1$ increases from $IL=IL_{MIN}=0$, and reaches IL_{MAX} .
- Step 2:** While Pch Tr. is "OFF" and synchronous rectifier Nch Tr. is "ON", L tries to maintain $IL= IL_{MAX}$, so $IL=i2$ flows into L.
- Step 3:** $IL=i2$ decreases gradually and reaches $IL=IL_{MIN}=0$ after the time while Pch Tr. is "OFF" and $IL=IL_{MIN}=0$ (t_{OPEN}). Then, synchronous rectifier Nch Tr. turns "OFF". Provided that in the continuous mode, next cycle starts before $IL=IL_{MIN}=0$ because the time while Pch Tr. is "OFF" (t_{OFF}) is not enough. In this case, IL value increases from this $IL_{MIN} (>0)$.

In the case of PWM mode, V_{OUT} is maintained by controlling t_{ON} . During PWM mode, the oscillator frequency (f_{osc}) is being maintained constant.

As shown in Figure 4., while the step-down operation is constant, the minimum inductor current (IL_{MIN}) and the maximum inductor current (IL_{MAX}) when Pch Tr. is "ON" would be same as the maximum and the minimum inductor currents when Pch Tr. is "OFF".

The current differential between IL_{MAX} and IL_{MIN} is described as ΔI .

$$\Delta I = IL_{MAX} - IL_{MIN} = V_{OUT} \times t_{OPEN} / L = (V_{IN} - V_{OUT}) \times t_{ON} / L \dots \dots \dots \text{Equation 1}$$

However,

$$T = 1 / f_{osc} = t_{ON} + t_{OFF}$$

$$\text{duty}(\%) = t_{ON} / T \times 100 = t_{ON} \times f_{osc} \times 100$$

$$t_{OPEN} \leq t_{OFF}$$

In Equation 1, " $V_{OUT} \times t_{OPEN} / L$ " show the amount of current change at " OFF ". Also, " $(V_{IN} - V_{OUT}) \times t_{ON} / L$ " shows the amount of current change at " ON ".

Discontinuous Mode and Continuous Mode

As illustrated in Figure 5., when the output current (I_{OUT}) is relatively small, $t_{OPEN} < t_{OFF}$. In this case, the energy charged into the inductor during t_{ON} will be completely discharged during t_{OFF} , as a result, $I_{LMIN}=0$. This is called discontinuous mode.

When I_{OUT} is gradually increased, eventually $t_{OPEN}=t_{OFF}$ and when I_{OUT} is increased further, eventually $I_{LMIN}>0$. This is called continuous mode.

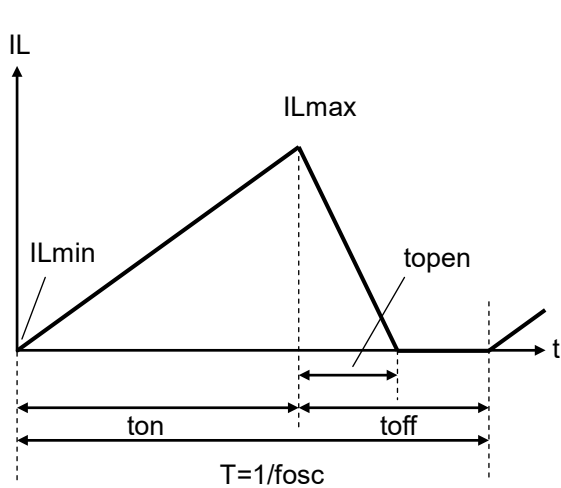

Figure 5. Discontinuous Mode

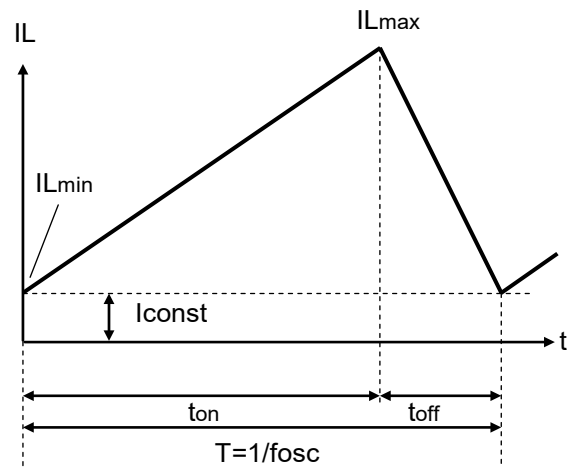

Figure 6. Continuous Mode

In the continuous mode, the solution of Equation 1 is $tonc$

$$tonc = T \times V_{OUT} / V_{IN} \dots \dots \dots \text{Equation 2}$$

When $t_{ON} < tonc$, it is discontinuous mode, and when $t_{ON} = tonc$, it is continuous mode.

Forced PWM Mode and VFM Mode

By setting the MODE pin to “H”, the IC switches the frequency at the fixed rate to reduce noise even when the output load is light. Therefore, when I_{OUT} is $\Delta I_L/2$ or less, I_{Lmin} becomes less than 0. That is, the accumulated electricity in CL is discharged through the IC side while IL is increasing from I_{Lmin} to 0 during t_{on} time, and also while IL is decreasing from 0 to I_{Lmin} during t_{off} time.

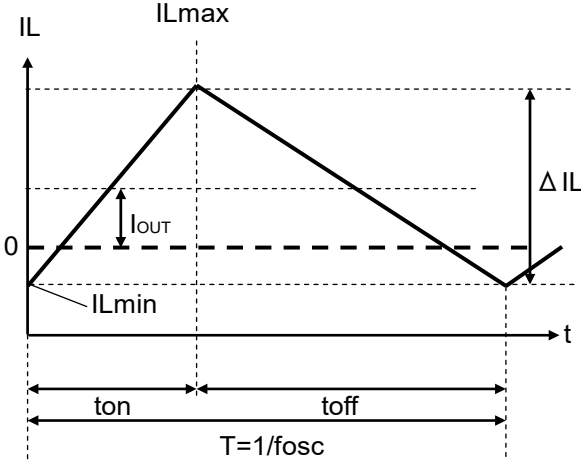

Figure 7. Forced PWM Mode

VFM Mode

By setting the MODE pin to “L”, in low output current, the IC automatically switches into VFM mode in order to achieve high efficiency. In VFM mode, t_{on} is forced to end when the inductor current reaches the pre-set I_{Lmax} . With the RP550K001A, I_{Lmax} in the VFM mode is typically set to 280mA. When t_{on} reaches 1.5 times of $T=1/f_{osc}$, t_{on} will be forced to end even if the inductor current is not reached I_{Lmax} .

Output Current and Selection of External Components

The following equations explain the relationship between output current and peripheral components used in Figure 2. in *Typical Applications* (P.7).

Ripple Current P-P value is described as I_{RP} , ON resistance of Pch Tr. is described as R_{ONP} , ON resistance of Nch Tr. is described as R_{ONN} , and DC resistor of the inductor is described as R_L .

First, when Pch Tr. is "ON", the following equation is satisfied.

$$V_{IN} = V_{OUT} + (R_{ONP} + R_L) \times I_{OUT} + L \times I_{RP} / t_{on} \dots\dots\dots \text{Equation 3}$$

Second, when Pch Tr. is "OFF" (Nch Tr. is "ON"), the following equation is satisfied.

$$L \times I_{RP} / t_{off} = R_{ONN} \times I_{OUT} + V_{OUT} + R_L \times I_{OUT} \dots\dots\dots \text{Equation 4}$$

Put Equation 4 into Equation 3 to solve ON duty of Pch Tr. ($D_{ON} = t_{on} / (t_{off} + t_{on})$):

$$D_{ON} = (V_{OUT} + R_{ONN} \times I_{OUT} + R_L \times I_{OUT}) / (V_{IN} + R_{ONN} \times I_{OUT} - R_{ONP} \times I_{OUT}) \dots\dots\dots \text{Equation 5}$$

Ripple Current is described as follows:

$$I_{RP} = (V_{IN} - V_{OUT} - R_{ONP} \times I_{OUT} - R_L \times I_{OUT}) \times D_{ON} / f_{osc} / L \dots\dots\dots \text{Equation 6}$$

Peak current that flows through L and Lx Tr. is described as follows:

$$I_{LXMAX} = I_{OUT} + I_{RP} / 2 \dots\dots\dots \text{Equation 7}$$

- ★ Please consider I_{LXMAX} when setting conditions of input and output, as well as selecting the external components.
- ★ The above calculation formulas are based on the ideal operation of the ICs in continuous mode.

TIMING CHART

(1) Soft Start Time

Starting-up with CE Pin

The IC starts to operate when the CE pin voltage (V_{CE}) exceed the threshold voltage. The threshold voltage is preset between CE “H” input voltage (V_{CEH}) and CE “L” input voltage (V_{CEL}).

After the start-up of the IC, soft-start circuit starts to operate. Then, after a certain period of time, the reference voltage (V_{REF}) in the IC gradually increases up to the specified value.

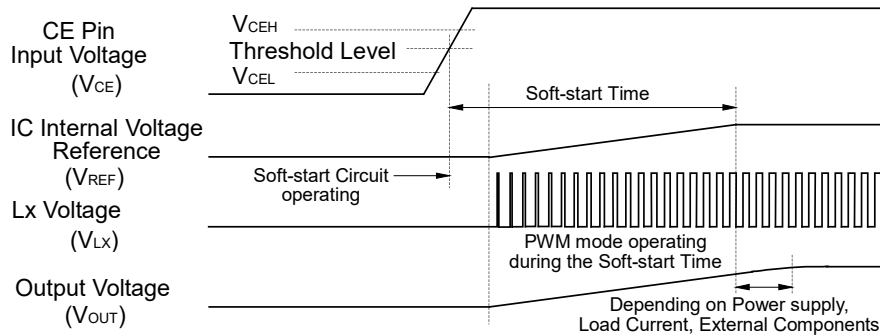

Figure 9. Timing Chart

Soft-start time starts when soft-start circuit activates, and ends when the reference voltage reaches the specified voltage.

- ★ Soft start time is not always equal to the turn-on speed of the step-down DC/DC converter. Please note that the turn-on speed could be affected by the power supply capacity, the output current, the inductance value and the C_{OUT} value.

Starting-up with Power Supply

After the power-on, the IC starts to operate when V_{IN} exceed the UVLO released voltage (V_{UVLO2}). Soft-start circuit starts to operate and then after a certain period of time, V_{REF} in the IC gradually increases up to the specified value. Soft-start time starts when soft-start circuit activates, and ends when V_{REF} reaches the specified voltage.

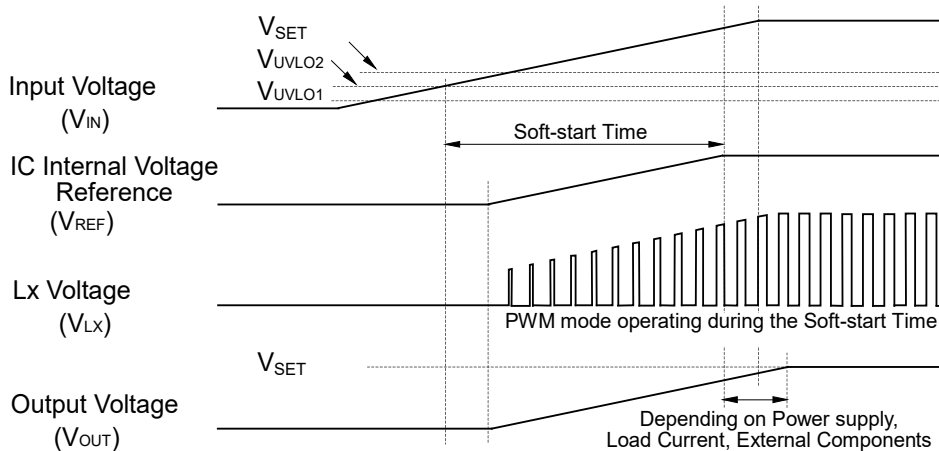

Figure 10. Timing Chart

Soft-start time starts when soft-start circuit activates, and ends when the reference voltage reaches the specified voltage.

- ★ Please note that the turn-on speed of V_{OUT} could be affected by the power supply capacity, the output current, the inductance value, the C_{OUT} value and the turn-on speed of V_{IN} determined by C_{IN} .

(2) Under Voltage Lockout (UVLO) Circuit

If V_{IN} becomes lower than the setting voltage (V_{SET}), the step-down DC/DC converter stops the switching operation and ON duty becomes 100%, and then V_{OUT} gradually drops according to V_{IN} .

If the V_{IN} drops more and becomes lower than the UVLO detector threshold (V_{UVLO1}), the UVLO circuit (UVLO) starts to operate, V_{REF} stops, and Pch and Nch built-in switch transistors turn "OFF". As a result, V_{OUT} drops according to the C_{OUT} capacitance value and the load.

To restart the operation, V_{IN} needs to be higher than V_{UVLO2} . The timing chart below shows the voltage shifts of V_{REF} , V_{LX} and V_{OUT} when V_{IN} value is varied.

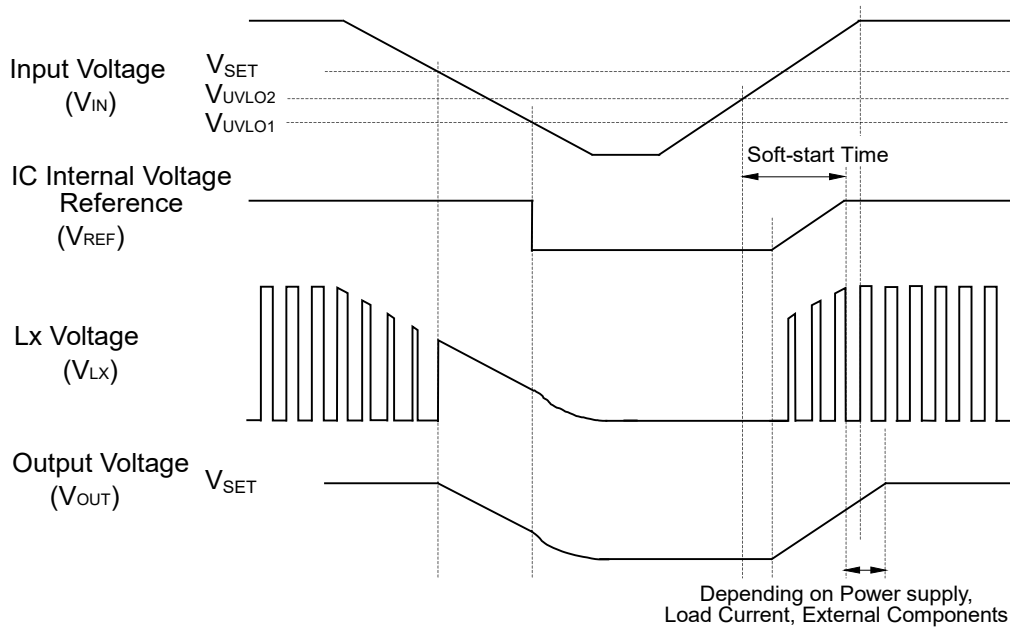

Figure 11. Timing Chart

- ★ Falling edge (operating) and rising edge (releasing) waveforms of V_{OUT} could be affected by the initial voltage of C_{OUT} and the output current of V_{OUT} .

(3) Over Current Protection Circuit, Latch Type Protection Circuit

Over current protection circuit supervises the inductor peak current (the peak current flowing through Pch Tr.) in each switching cycle, and if the current exceeds the Lx current limit (I_{LXLIM}), it turns off Pch Tr. I_{LXLIM} of the RP550K001A is set to Typ.1700mA.

Latch type protection circuit latches the built-in driver to the OFF state and stops the operation of the step-down DC/DC converter if the over current status continues or V_{OUT} continues being the half of the setting voltage for equal or longer than protection delay time (t_{prot}).

Note: I_{LXLIM} and t_{prot} could be easily affected by self-heating or ambient environment. If the V_{IN} drops dramatically or becomes unstable due to short-circuit, protection operation and t_{prot} could be affected.

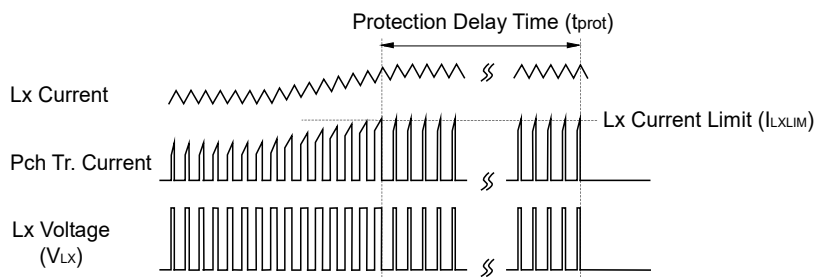

Figure 12. Protection Delay Time

To release the latch type protection circuit, restart the IC by inputting "L" signal to the CE pin, or restart the IC with power-on or make the supply voltage lower than V_{UVLO1} .

The timing chart below shows the voltage shifts of V_{LX} and V_{OUT} when the IC status is changed by the following orders: V_{IN} and V_{CE} rising → stable operation → high load → CE reset → stable operation → high load → V_{IN} falling → V_{IN} recovering (UVLO reset) → stable operation.

- (1)(2) If the large current flows through the circuit or the IC goes into low V_{OUT} condition due to short-circuit or other reasons, the latch type protection circuit latches the built-in driver to "OFF" state after t_{prot} . Then, V_{LX} becomes "L" and V_{OUT} turns "OFF".
- (3) The latch type protection circuit is released by CE reset, which puts the IC into "L" once with the CE pin and back into "H".
- (4) The latch type protection circuit is released by UVLO reset, which makes V_{IN} lower than V_{UVLO1} .

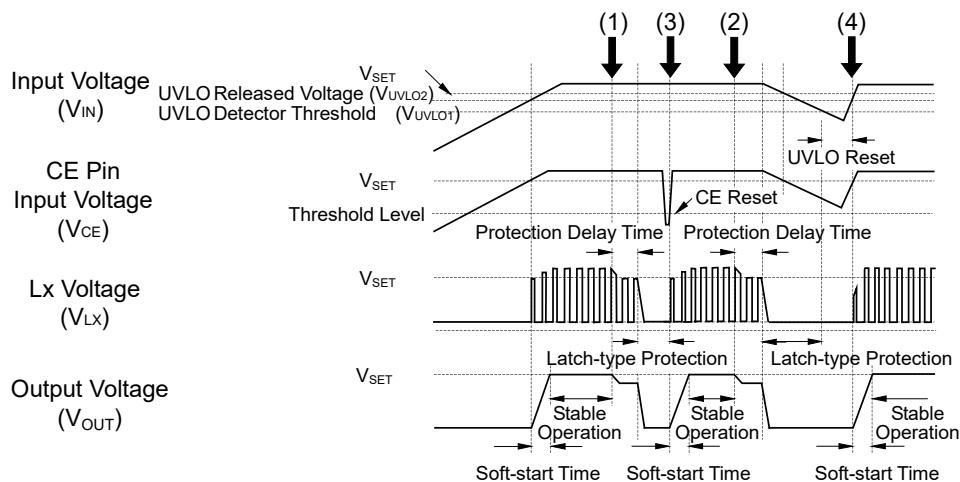

Figure 13. Timing Chart

CHARACTERISTICS

1) Output Voltage vs. Output Current

RP550K001A $V_{OUT}=0.6V$

MODE="L" PWM/VFM Auto Switching Control

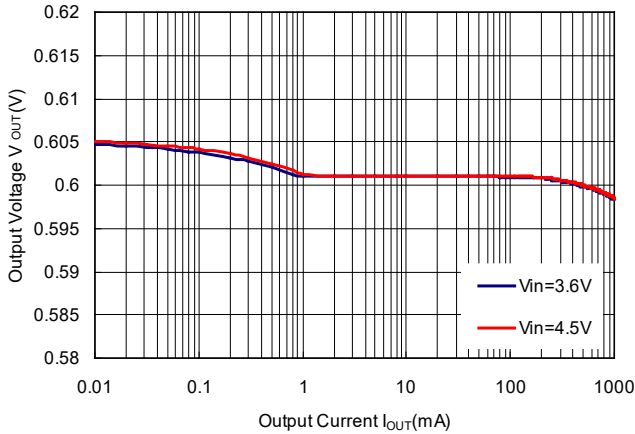

RP550K001A $V_{OUT}=0.6V$

MODE="H" Forced PWM Control

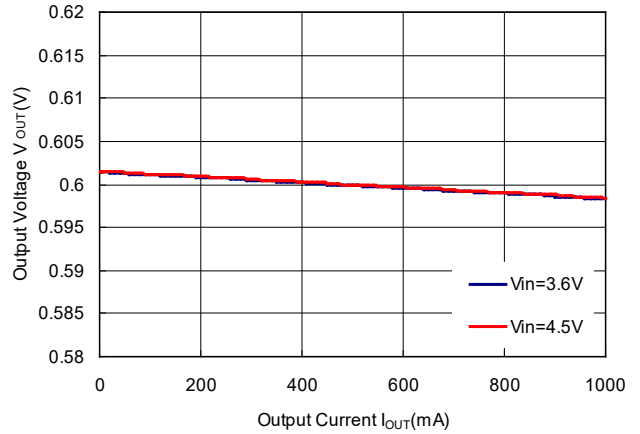

RP550K001A $V_{OUT}=0.8V$

MODE="L" PWM/VFM Auto Switching Control

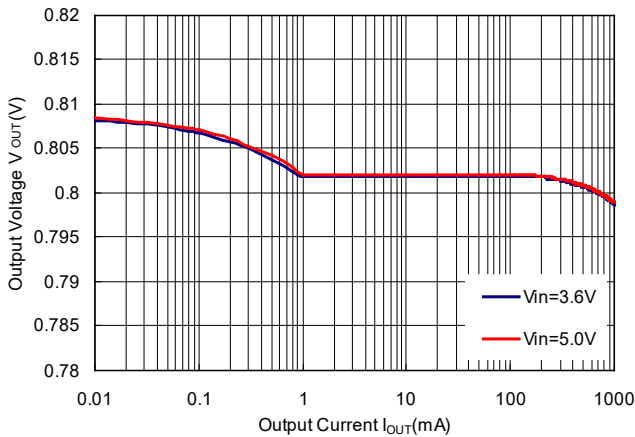

RP550K001A $V_{OUT}=0.8V$

MODE="H" Forced PWM Control

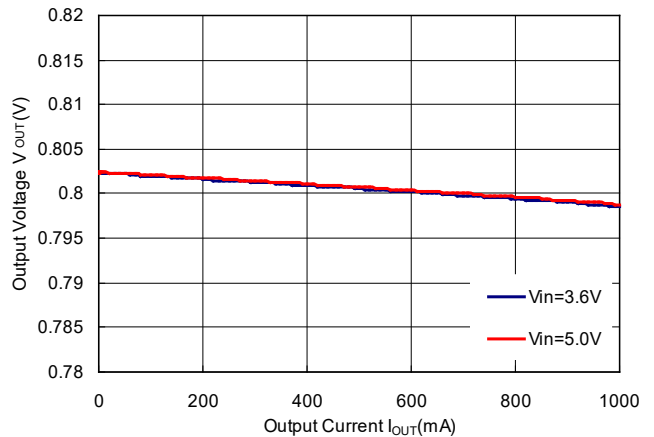

RP550K001A $V_{OUT}=1.2V$

MODE="L" PWM/VFM Auto Switching Control

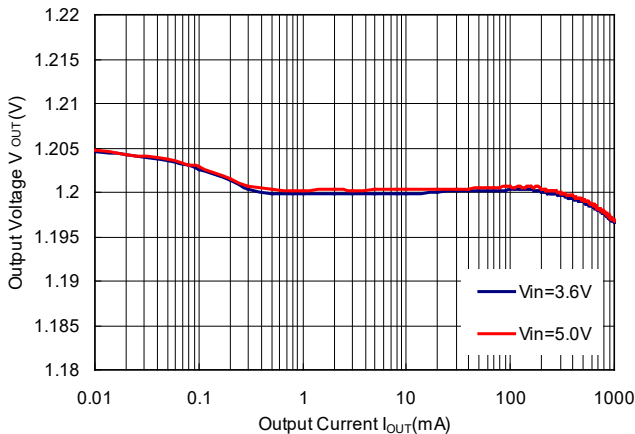

RP550K001A $V_{OUT}=1.2V$

MODE="H" Forced PWM Control

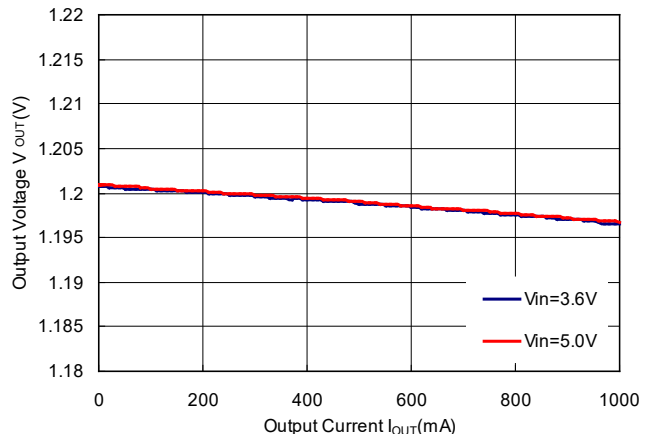

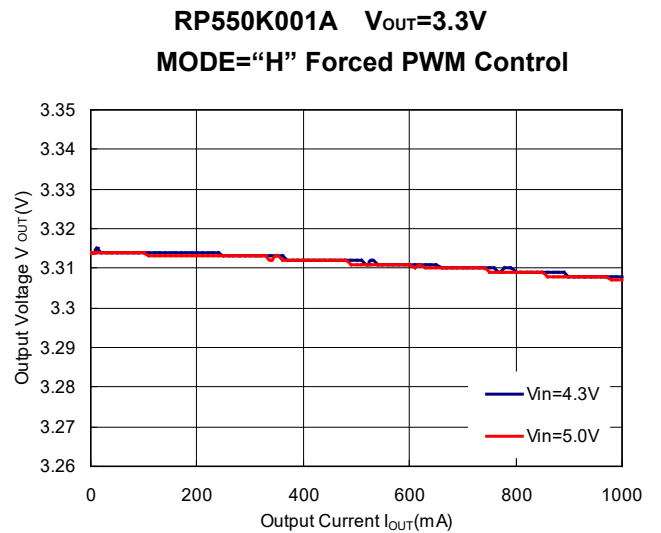
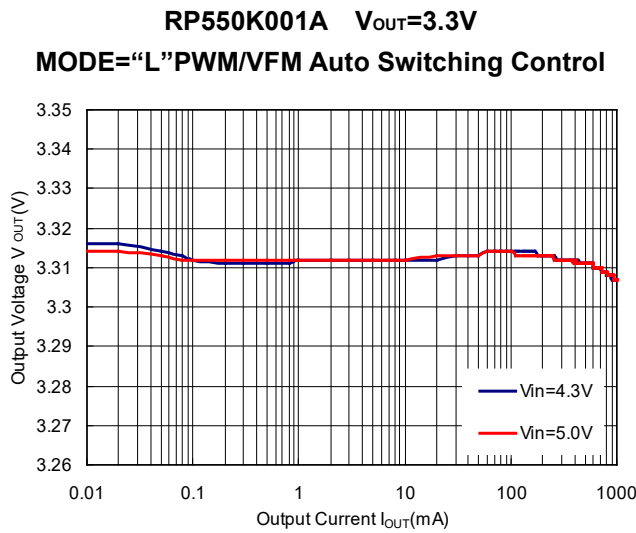
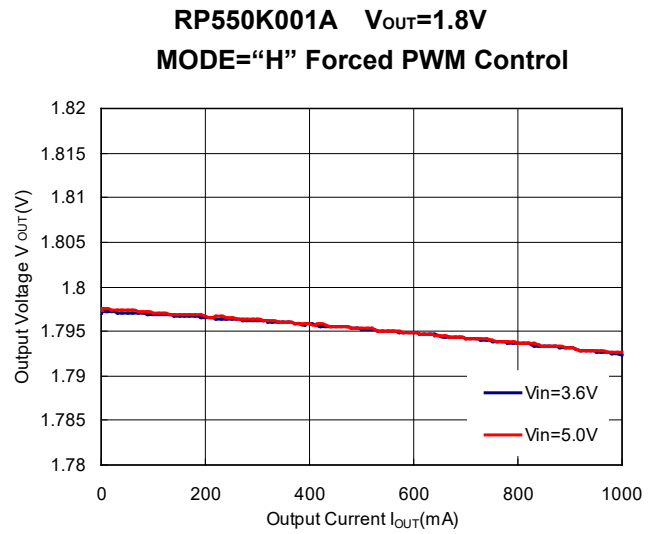
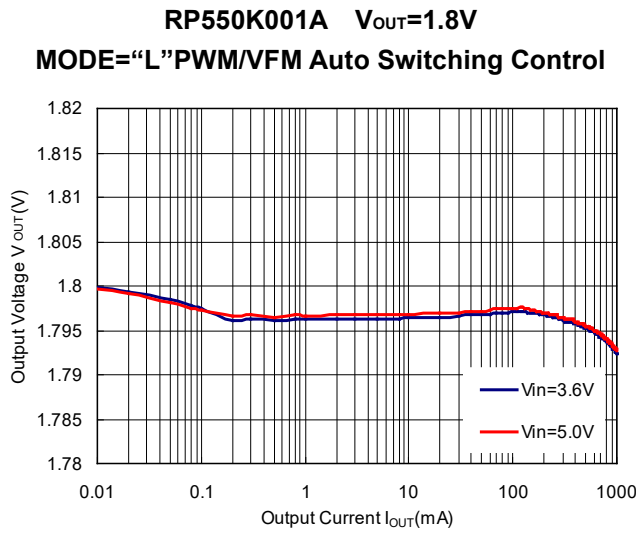

2) Output Voltage vs. Input Voltage

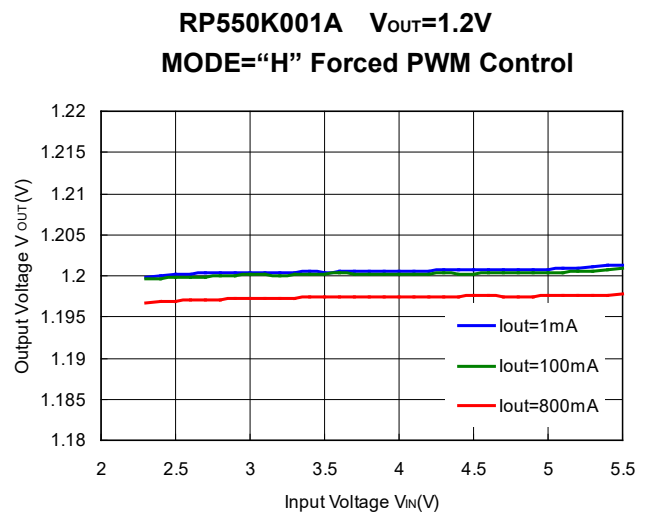
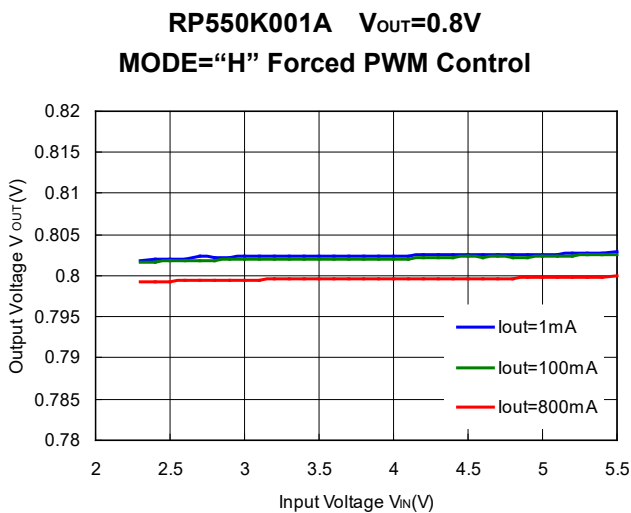

**RP550K001A $V_{OUT}=1.8V$
MODE="H" Forced PWM Control**

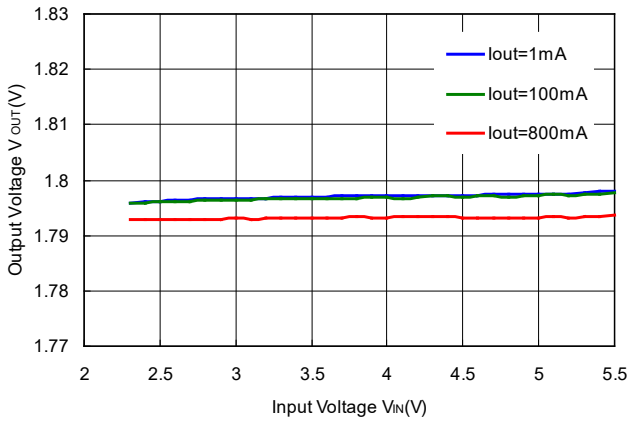

**RP550K001A $V_{OUT}=3.3V$
MODE="H" Forced PWM Control**

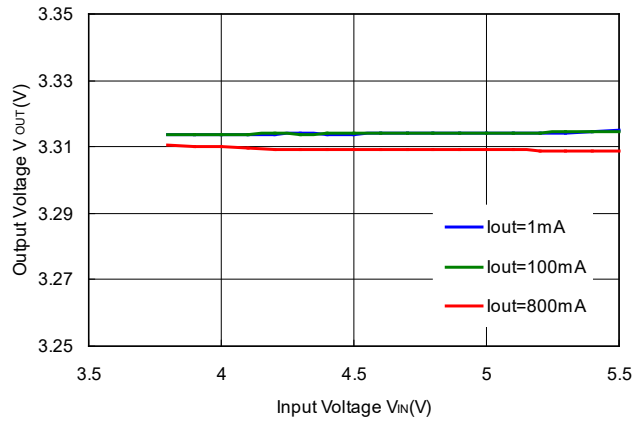

3) Feedback Voltage vs. Ambient Temperature

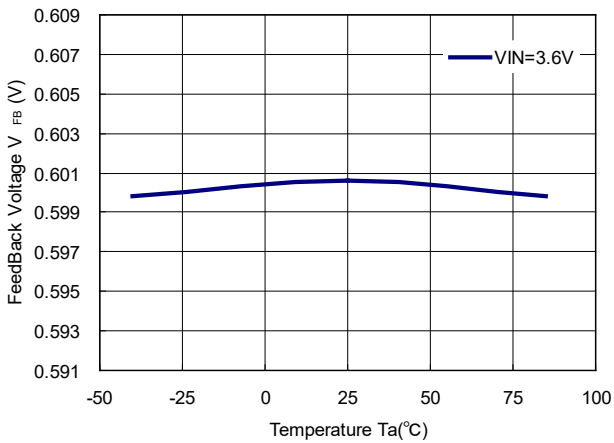

4) Efficiency vs. Output Current

RP550K001A $V_{OUT}=0.6V$

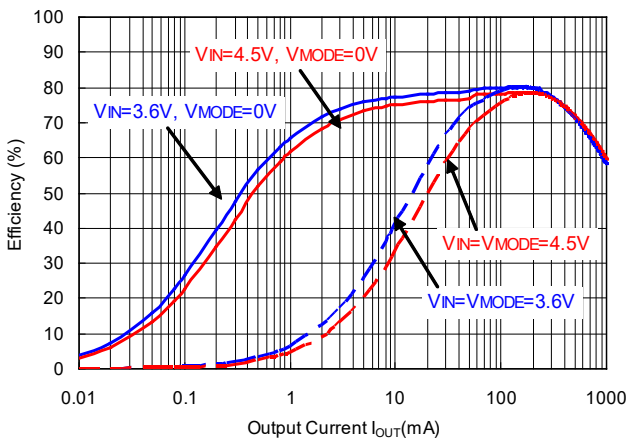

RP550K001A $V_{OUT}=0.8V$

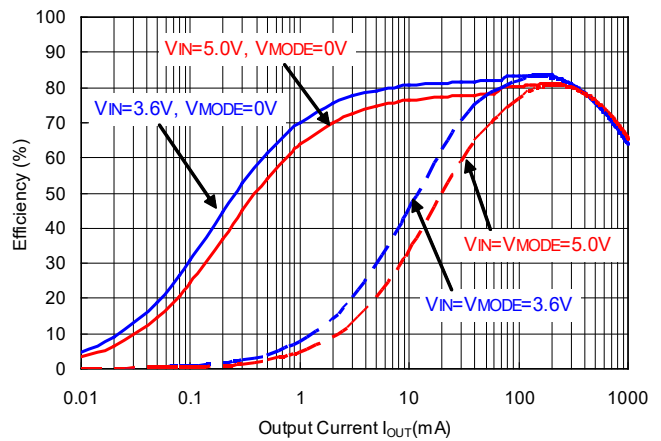

RP550K001A $V_{OUT}=1.2V$

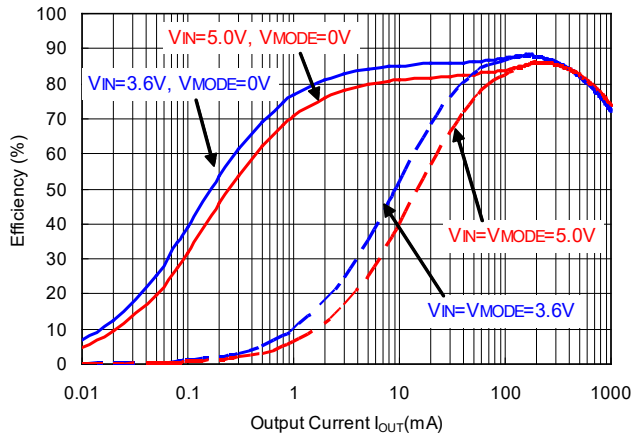

RP550K001A $V_{OUT}=1.8V$

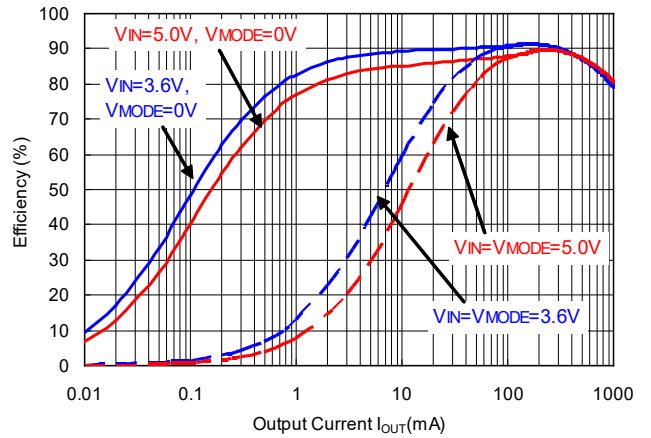

RP550K001A $V_{OUT}=3.3V$

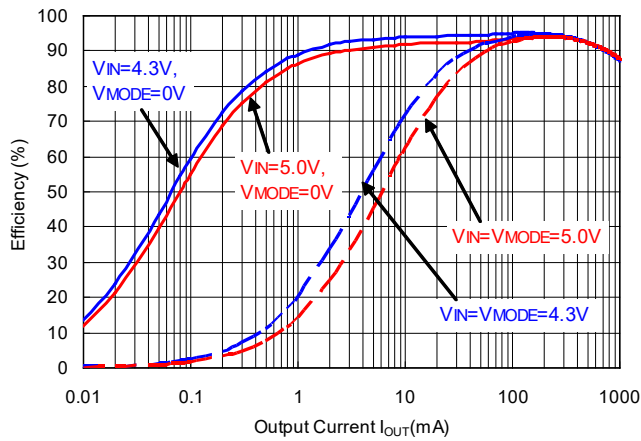

5) Supply Current vs. Ambient Temperature

RP550K001A $V_{OUT}=1.8V(V_{IN}=5.5V)$

MODE="L" PWM/VFM Auto Switching Control

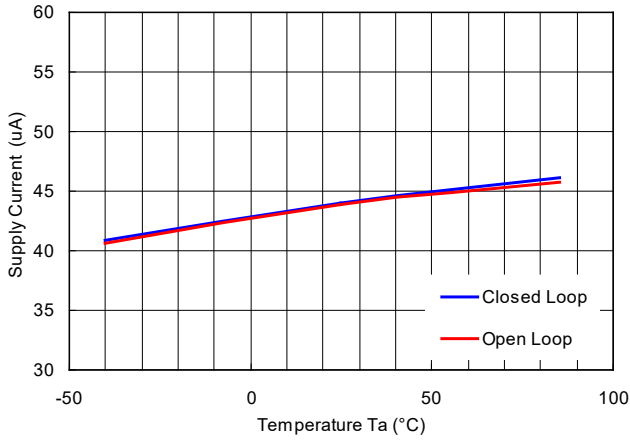

6) Supply Current vs. Input Voltage

RP550K001A $V_{OUT}=1.8V$

MODE="L" PWM/VFM Auto Switching Control

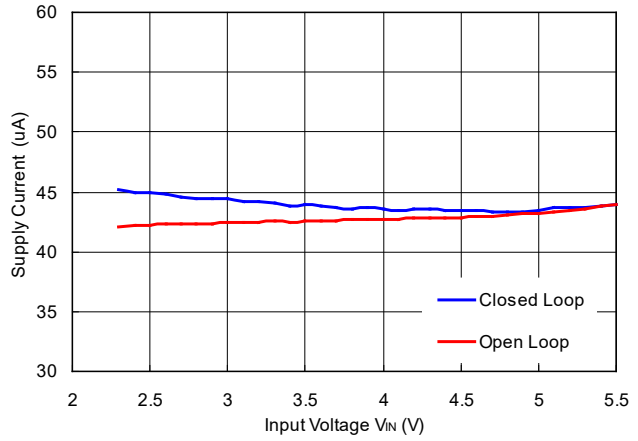

7) Output Voltage Waveform

RP550K001A $V_{OUT}=0.6V(V_{IN}=3.6V)$

MODE="L" PWM/VFM Auto Switching Control

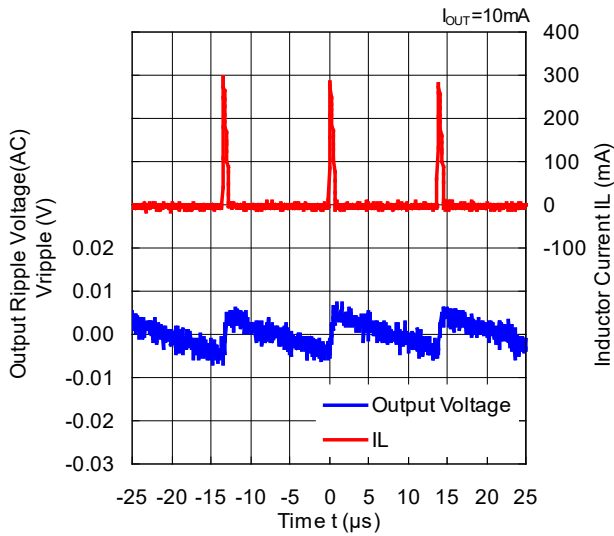

RP550K001A $V_{OUT}=0.6V(V_{IN}=3.6V)$

MODE="H" Forced PWM Control

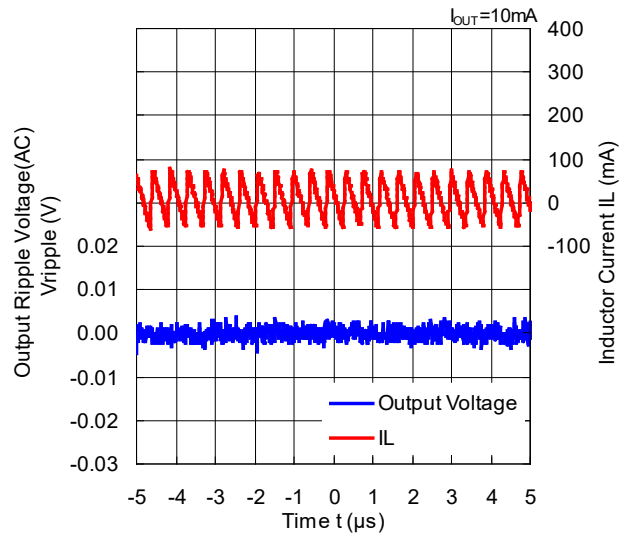

**RP550K001A $V_{OUT}=0.8V(V_{IN}=3.6V)$
MODE="L" PWM/VFM Auto Switching Control**

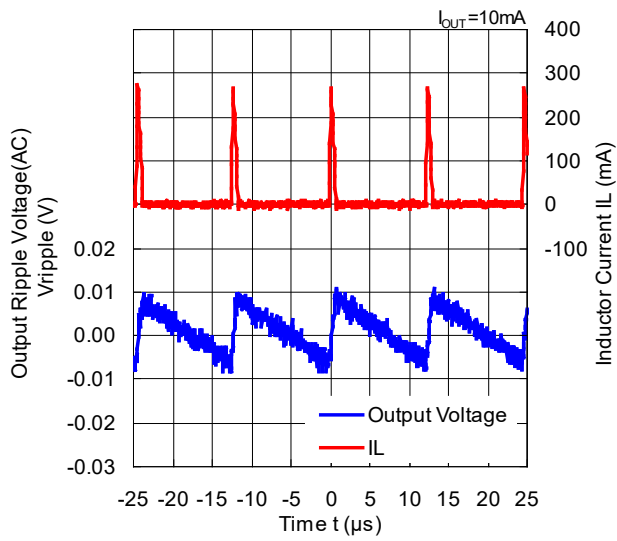

**RP550K001A $V_{OUT}=0.8V(V_{IN}=3.6V)$
MODE="H" Forced PWM Control**

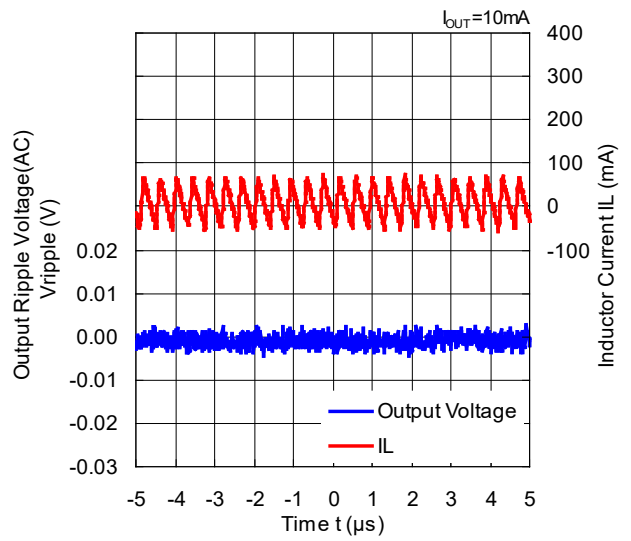

**RP550K001A $V_{OUT}=1.2V(V_{IN}=3.6V)$
MODE="L" PWM/VFM Auto Switching Control**

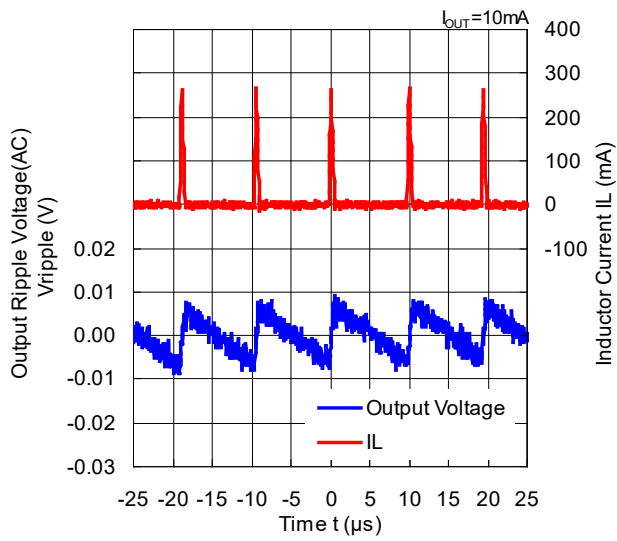

**RP550K001A $V_{OUT}=1.2V(V_{IN}=3.6V)$
MODE="H" Forced PWM Control**

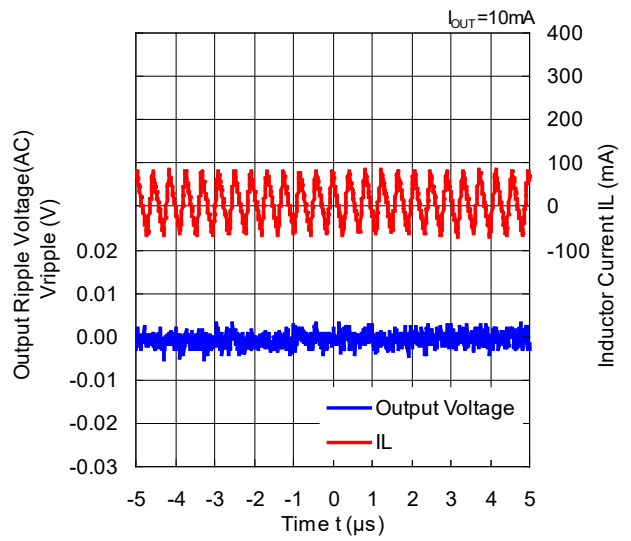

**RP550K001A $V_{OUT}=1.8V(V_{IN}=3.6V)$
MODE="L" PWM/VFM Auto Switching Control**

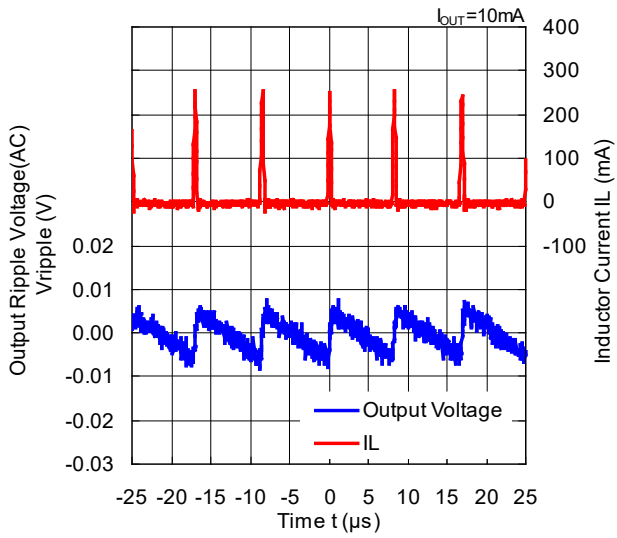

**RP550K001A $V_{OUT}=1.8V(V_{IN}=3.6V)$
MODE="H" Forced PWM Control**

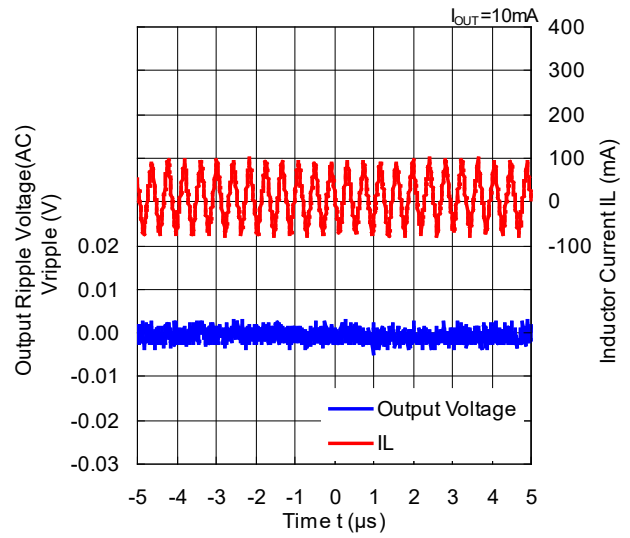

**RP550K001A $V_{OUT}=3.3V(V_{IN}=4.3V)$
MODE="L" PWM/VFM Auto Switching Control**

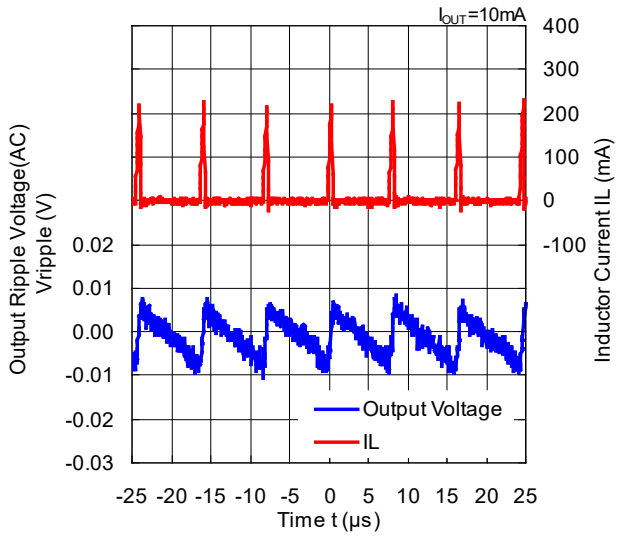

**RP550K001A $V_{OUT}=3.3V(V_{IN}=4.3V)$
MODE="H" Forced PWM Control**

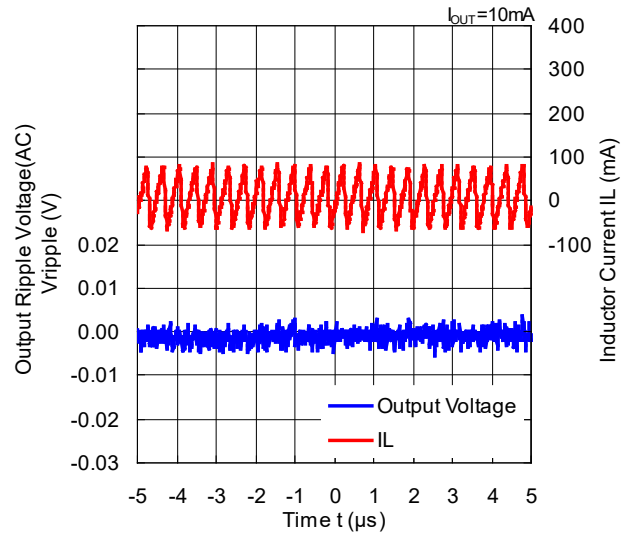

8) Oscillator Frequency vs. Ambient Temperature

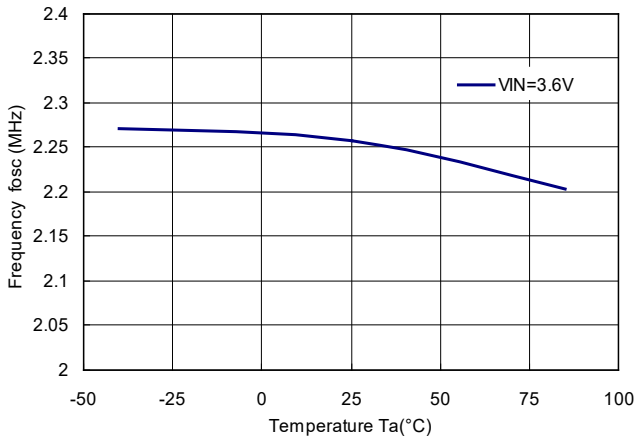

9) Oscillator Frequency vs. Input Voltage

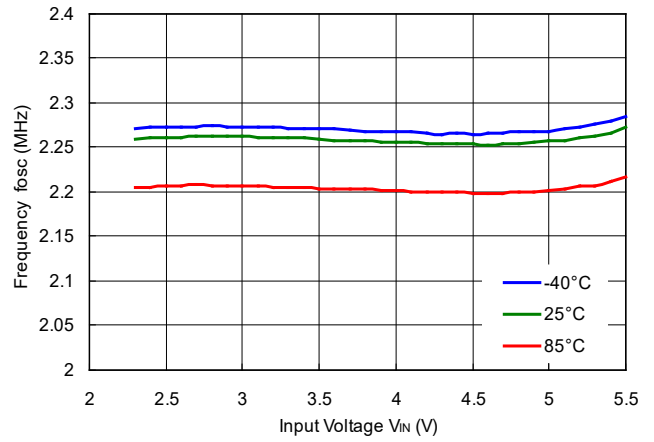

10) Soft-start Time vs. Ambient Temperature

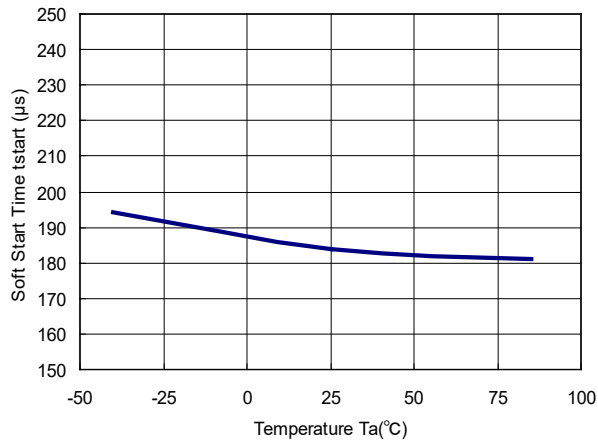

11) UVLO Detector/ Released Threshold vs. Ambient Temperature

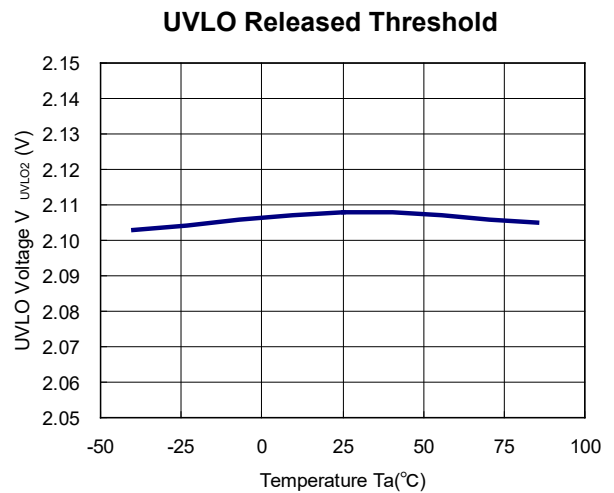
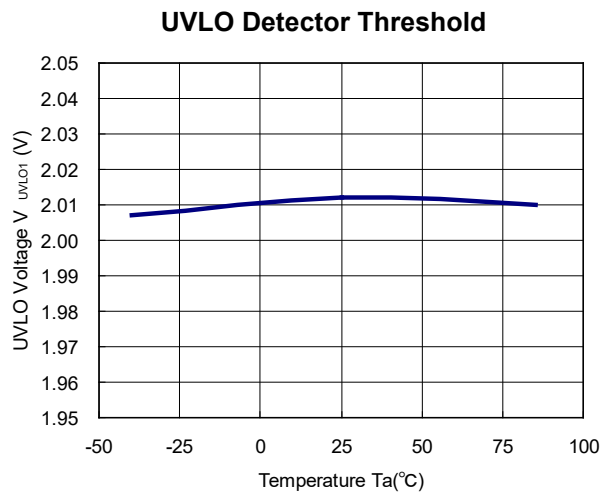

12) CE Input Voltage vs. Ambient Temperature

CE "H" Input Voltage ($V_{IN}=5.5V$)

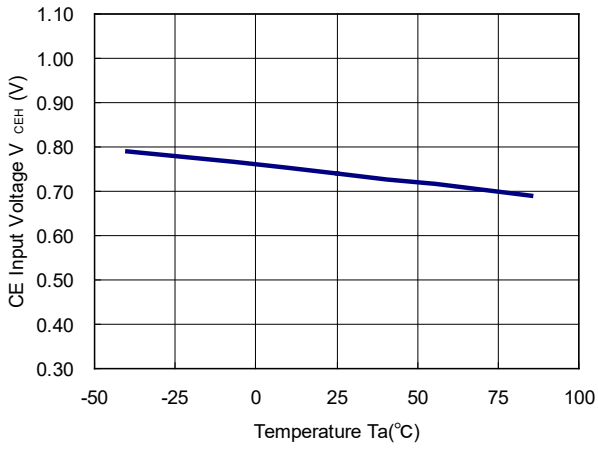

CE "L" Input Voltage ($V_{IN}=2.3V$)

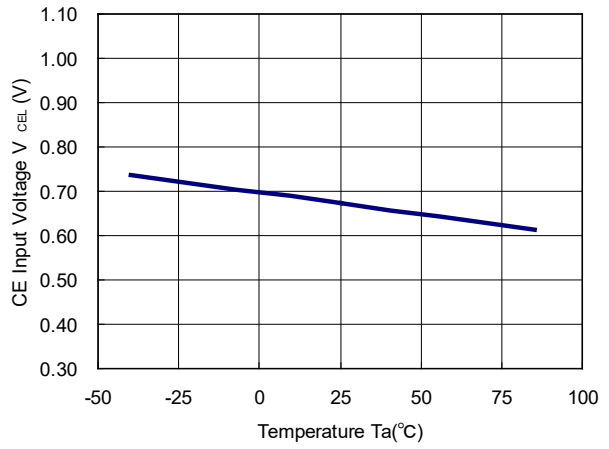

13) Lx Limit Current vs. Ambient Temperature

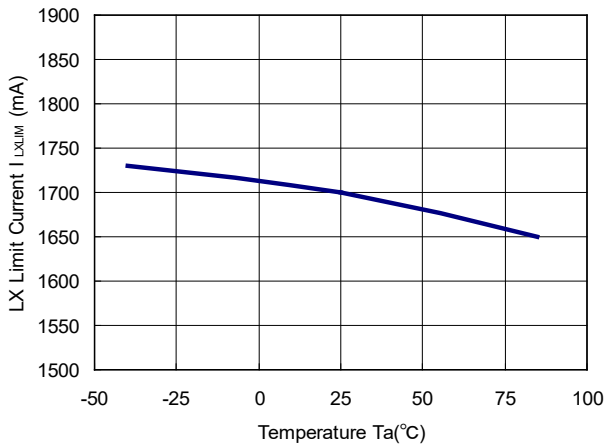

14) Nch Transistor ON Resistance vs. Ambient Temperature

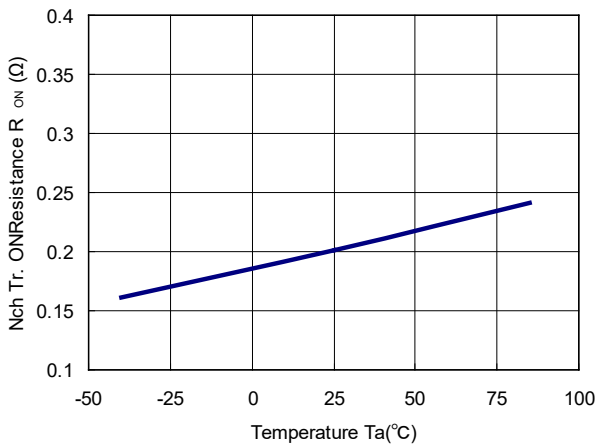

15) Pch Transistor ON Resistance vs. Ambient Temperature

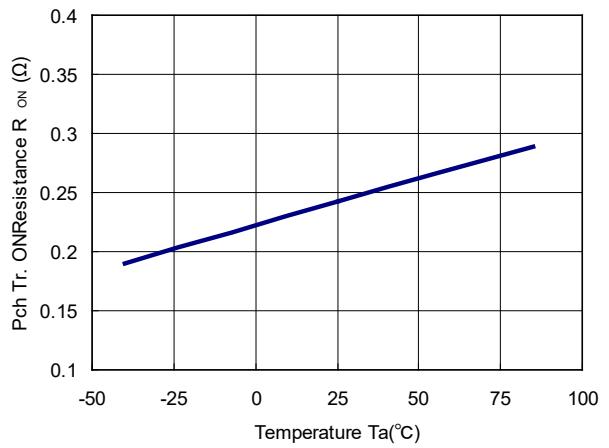

16) Load Transient Response

RP550K001A ($V_{IN}=3.6V$, $V_{OUT}=0.6V$)

MODE="L" PWM/VFM Auto Switching Control

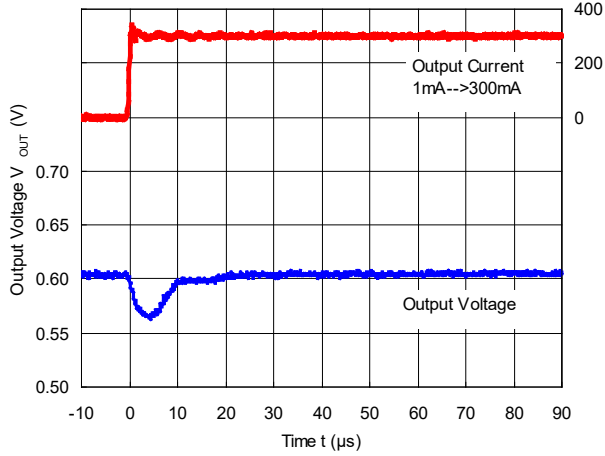

RP550K001A ($V_{IN}=3.6V$, $V_{OUT}=0.6V$)

MODE="L" PWM/VFM Auto Switching Control

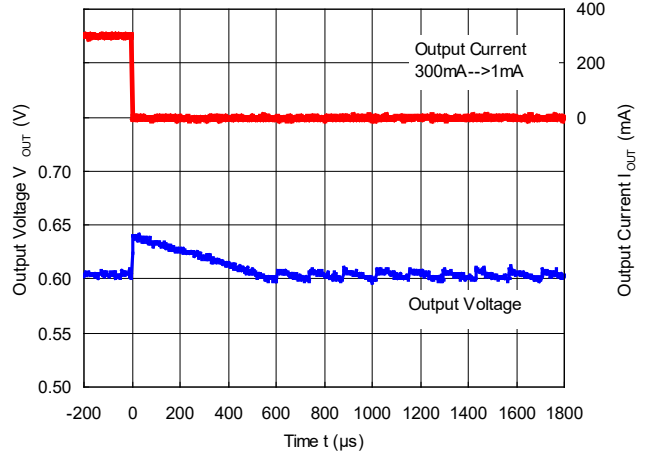

RP550K001A ($V_{IN}=3.6V$, $V_{OUT}=0.6V$)

MODE="H" Forced PWM Control

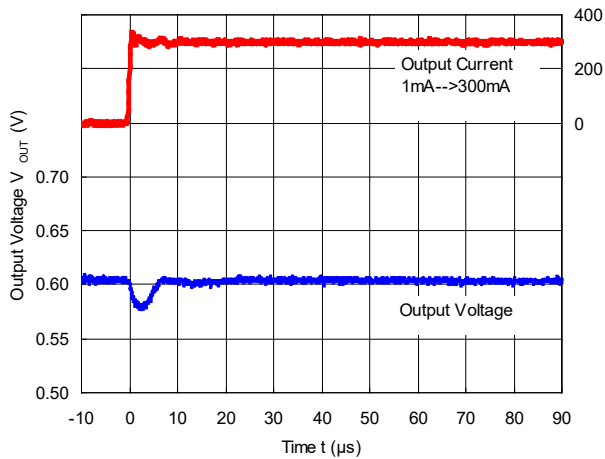

RP550K001A ($V_{IN}=3.6V$, $V_{OUT}=0.6V$)

MODE="H" Forced PWM Control

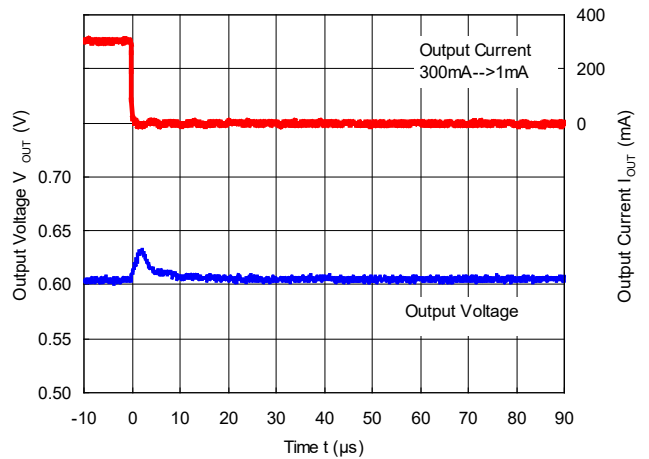

RP550K001A ($V_{IN}=3.6V$, $V_{OUT}=0.6V$)

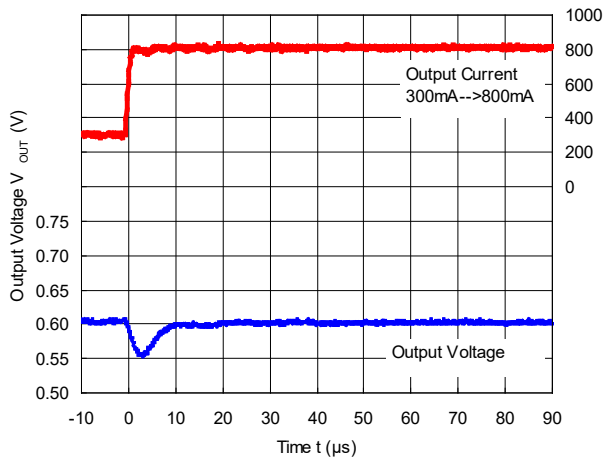

RP550K001A ($V_{IN}=3.6V$, $V_{OUT}=0.6V$)

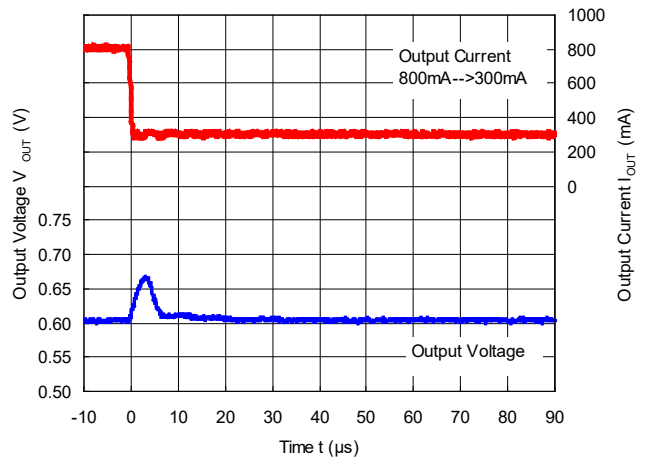

RP550K001A ($V_{IN}=3.6V$, $V_{OUT}=0.8V$)

MODE="L" PWM/VFM Auto Switching Control

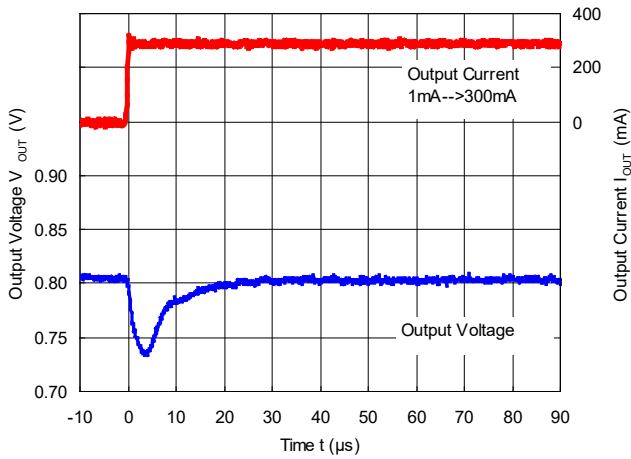

RP550K001A ($V_{IN}=3.6V$, $V_{OUT}=0.8V$)

MODE="L" PWM/VFM Auto Switching Control

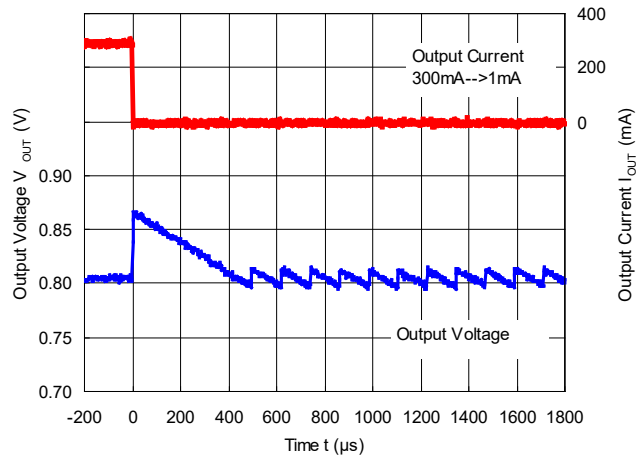

RP550K001A ($V_{IN}=3.6V$, $V_{OUT}=0.8V$)

MODE="H" Forced PWM Control

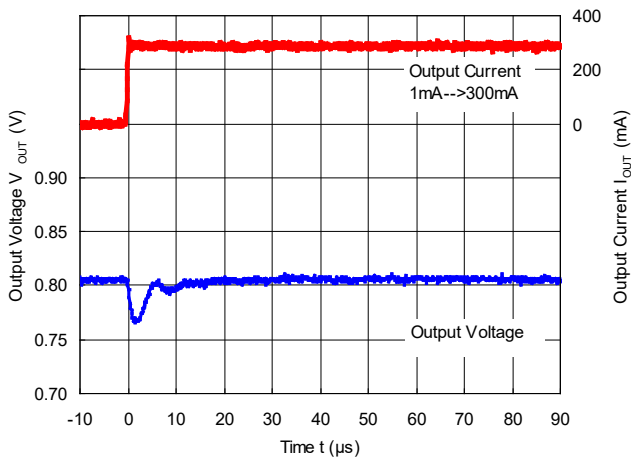

RP550K001A ($V_{IN}=3.6V$, $V_{OUT}=0.8V$)

MODE="H" Forced PWM Control

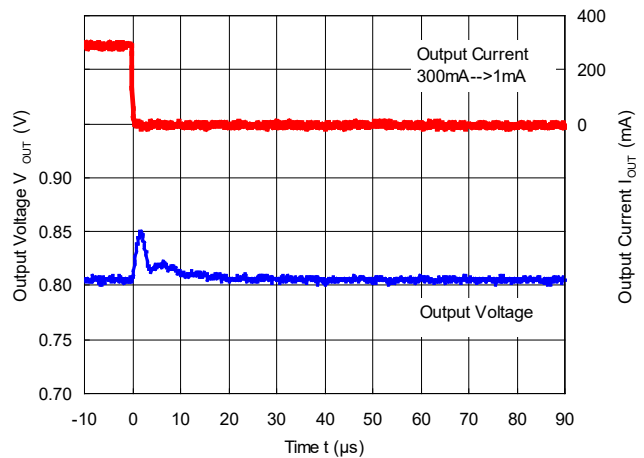

RP550K001A ($V_{IN}=3.6V$, $V_{OUT}=0.8V$)

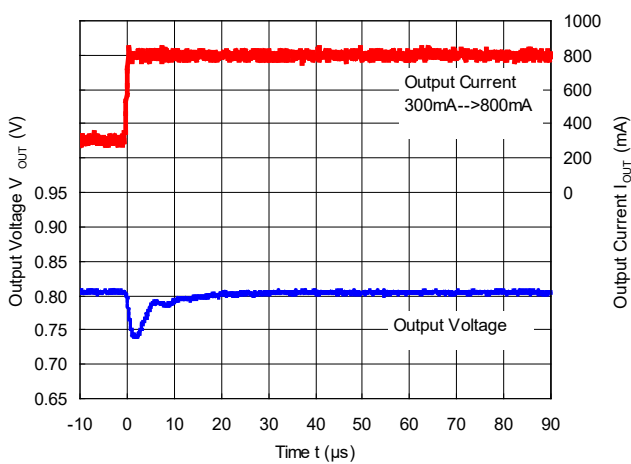

RP550K001A ($V_{IN}=3.6V$, $V_{OUT}=0.8V$)

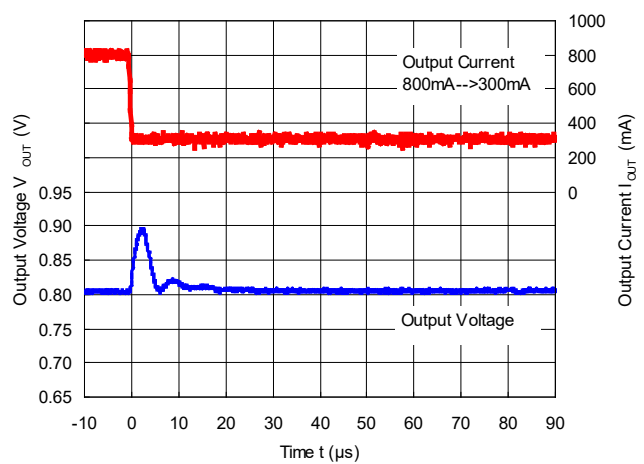

RP550K001A (V_{IN}=3.6V, V_{OUT}=1.2V)
MODE="L" PWM/VFM Auto Switching Control

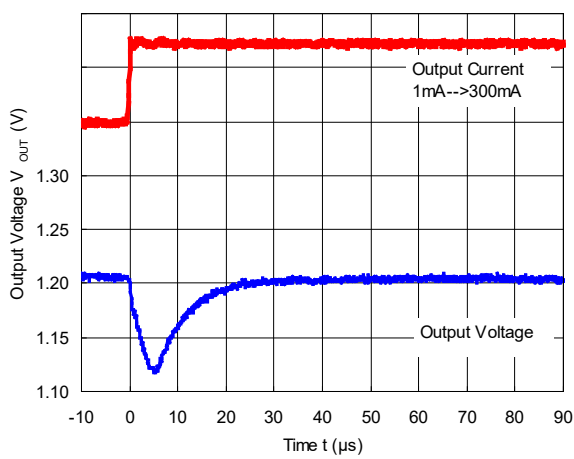

RP550K001A (V_{IN}=3.6V, V_{OUT}=1.2V)
MODE="L" PWM/VFM Auto Switching Control

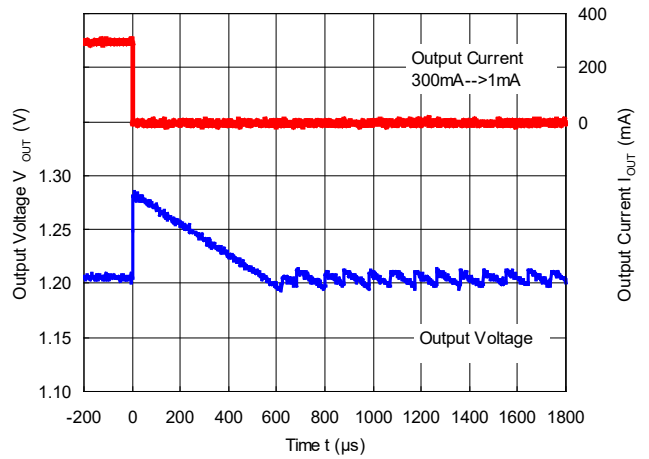

RP550K001A (V_{IN}=3.6V, V_{OUT}=1.2V)
MODE="H" Forced PWM Control

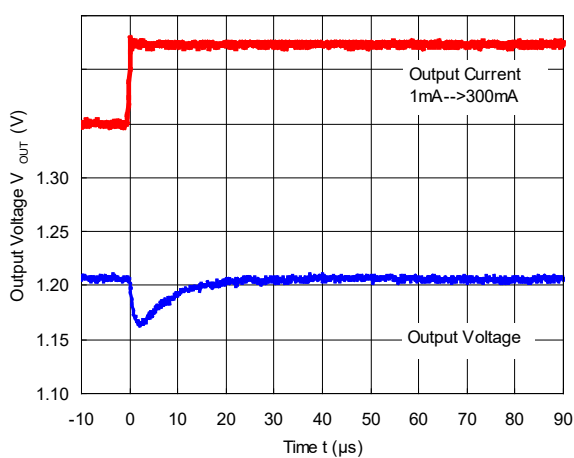

RP550K001A (V_{IN}=3.6V, V_{OUT}=1.2V)
MODE="H" Forced PWM Control

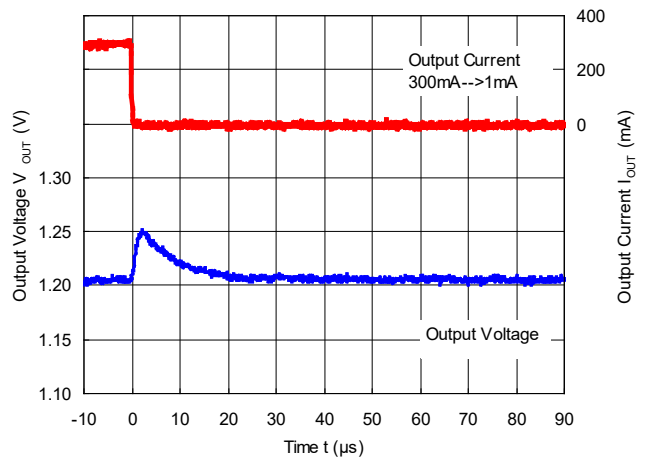

RP550K001A (V_{IN}=3.6V, V_{OUT}=1.2V)

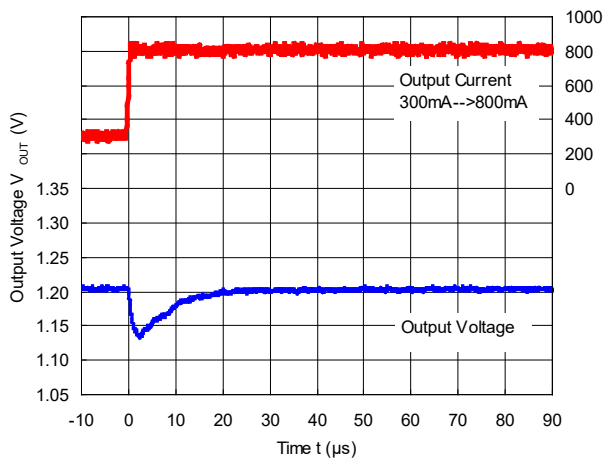

RP550K001A (V_{IN}=3.6V, V_{OUT}=1.2V)

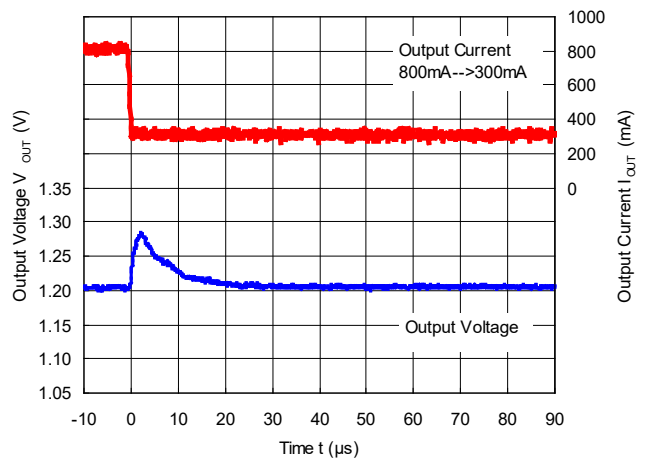

RP550K001A ($V_{IN}=3.6V$, $V_{OUT}=1.8V$)
 MODE="L" PWM/VFM Auto Switching Control

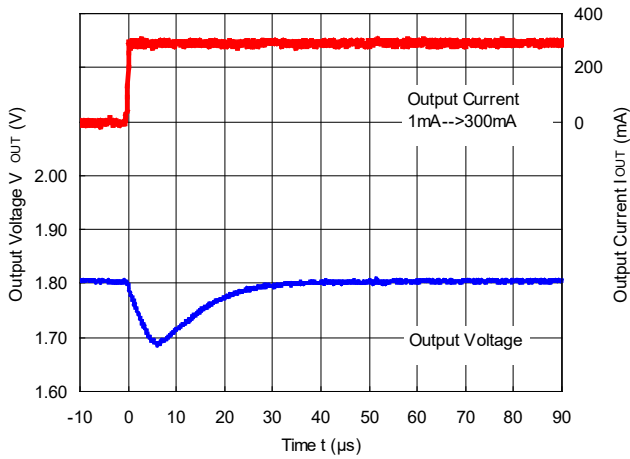

RP550K001A ($V_{IN}=3.6V$, $V_{OUT}=1.8V$)
 MODE="L" PWM/VFM Auto Switching Control

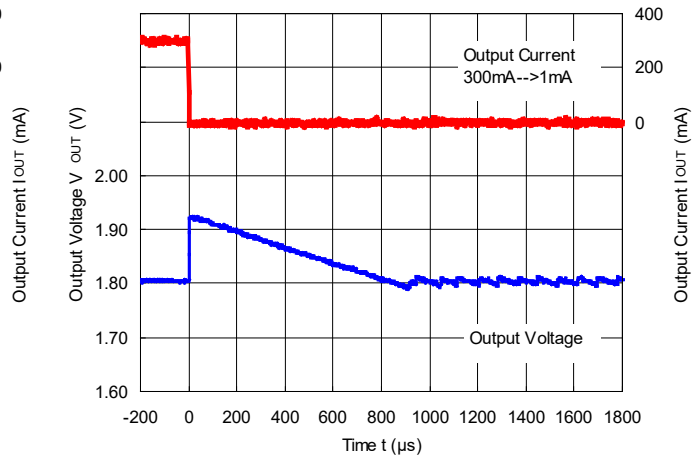

RP550K001A ($V_{IN}=3.6V$, $V_{OUT}=1.8V$)
 MODE="H" Forced PWM Control

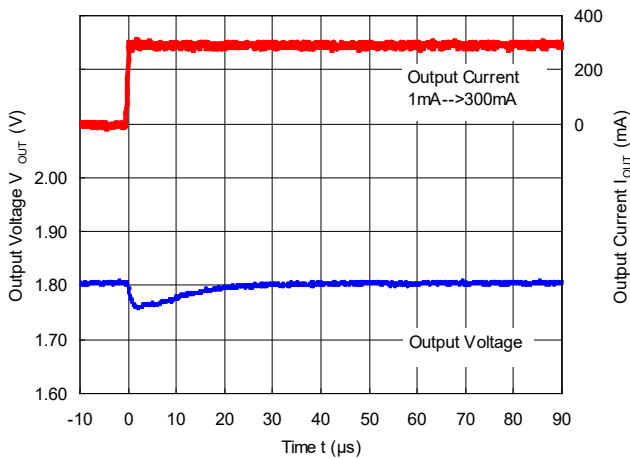

RP550K001A ($V_{IN}=3.6V$, $V_{OUT}=1.8V$)
 MODE="H" Forced PWM Control

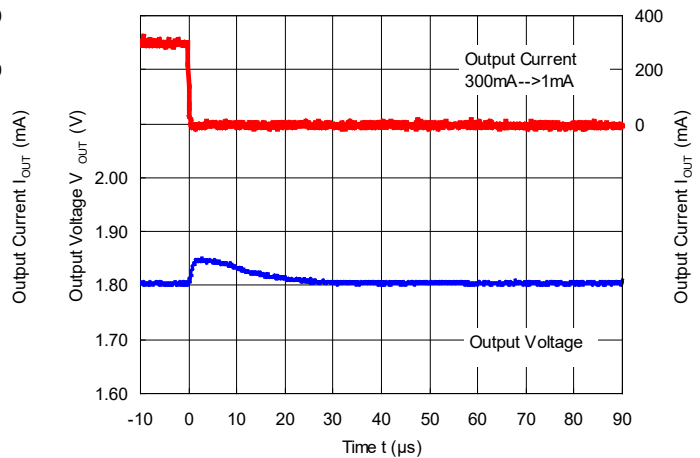

RP550K001A ($V_{IN}=3.6V$, $V_{OUT}=1.8V$)

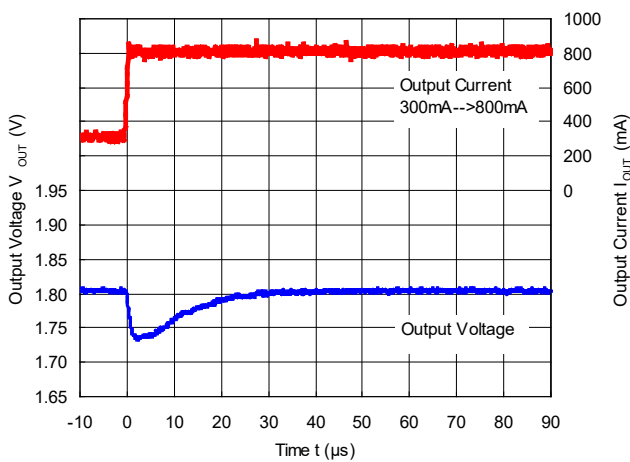

RP550K001A ($V_{IN}=3.6V$, $V_{OUT}=1.8V$)

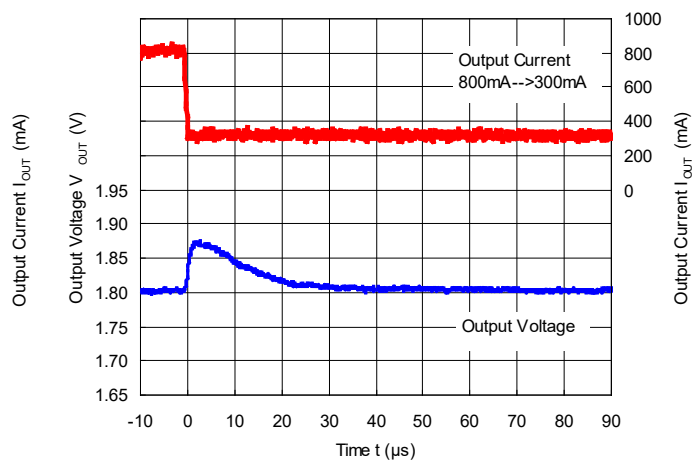

RP550K001A (V_{IN}=5.0V, V_{OUT}=3.3V)
MODE="L" PWM/VFM Auto Switching Control

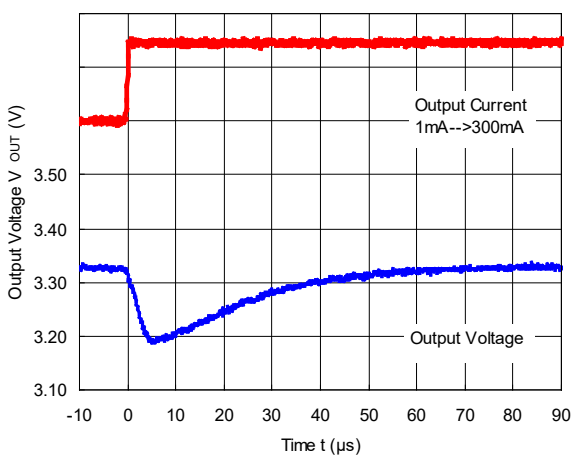

RP550K001A (V_{IN}=5.0V, V_{OUT}=3.3V)
MODE="L" PWM/VFM Auto Switching Control

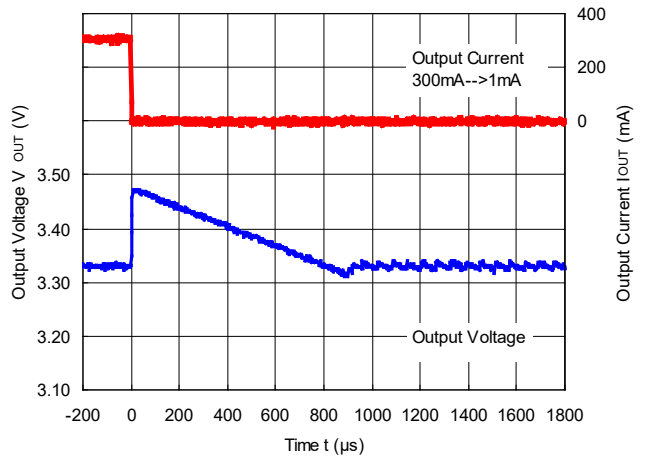

RP550K001A (V_{IN}=5.0V, V_{OUT}=3.3V)
MODE="H" Forced PWM Control

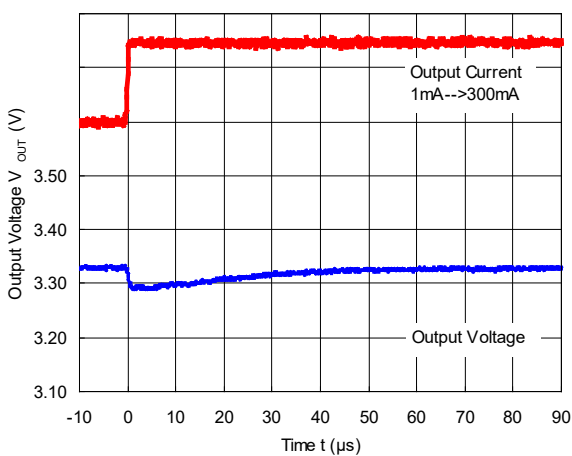

RP550K001A (V_{IN}=5.0V, V_{OUT}=3.3V)
MODE="H" Forced PWM Control

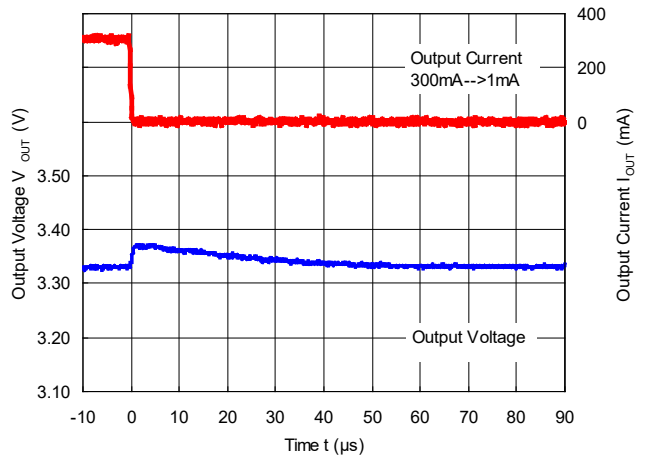

RP550K001A (V_{IN}=5.0V, V_{OUT}=3.3V)

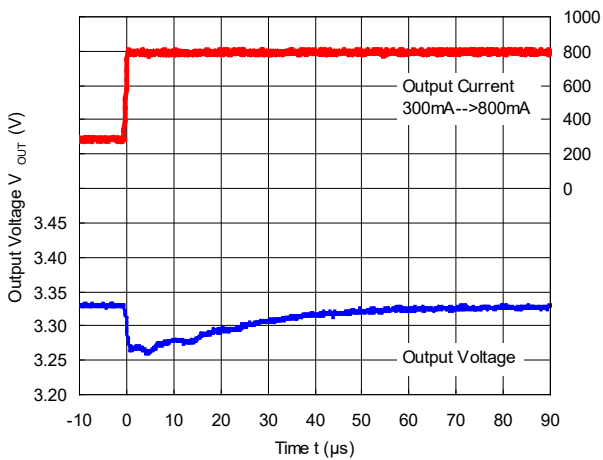

RP550K001A (V_{IN}=5.0V, V_{OUT}=3.3V)

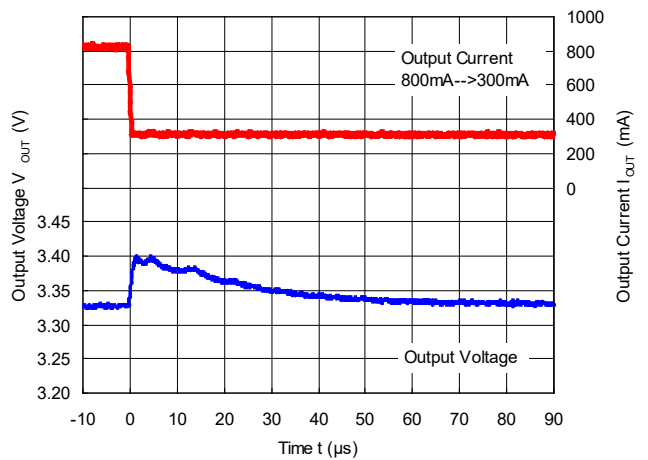

17) Mode Switching Waveform

RP550K001A ($V_{IN}=3.6V$, $V_{OUT}=1.2V$, $I_{OUT}=1mA$)
 MODE="L" --> MODE="H"

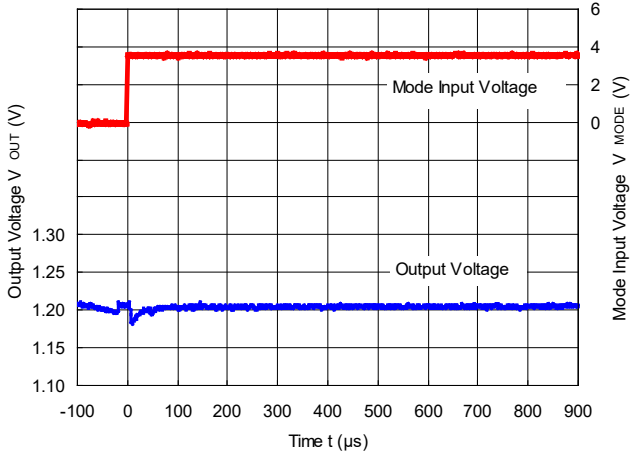

RP550K001A ($V_{IN}=3.6V$, $V_{OUT}=1.2V$, $I_{OUT}=1mA$)
 MODE="H" --> MODE="L"

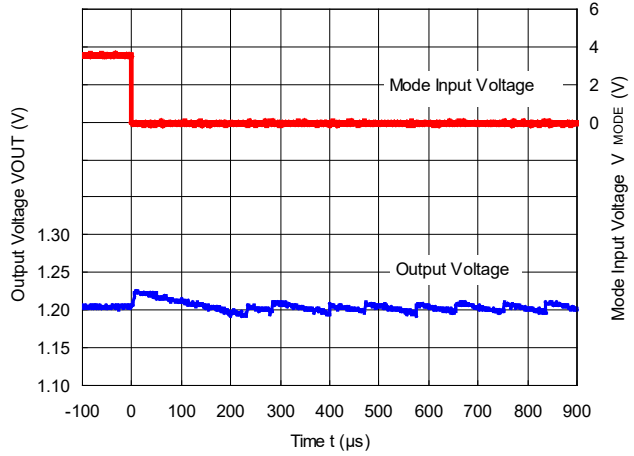

RP550K001A ($V_{IN}=3.6V$, $V_{OUT}=1.8V$, $I_{OUT}=1mA$)
 MODE="L" --> MODE="H"

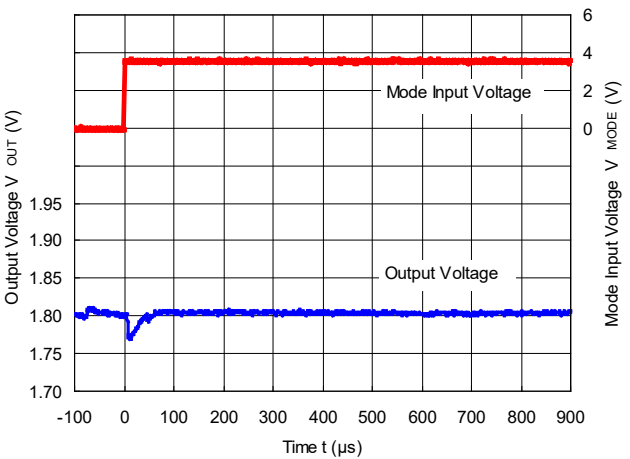

RP550K001A ($V_{IN}=3.6V$, $V_{OUT}=1.8V$, $I_{OUT}=1mA$)
 MODE="H" --> MODE="L"

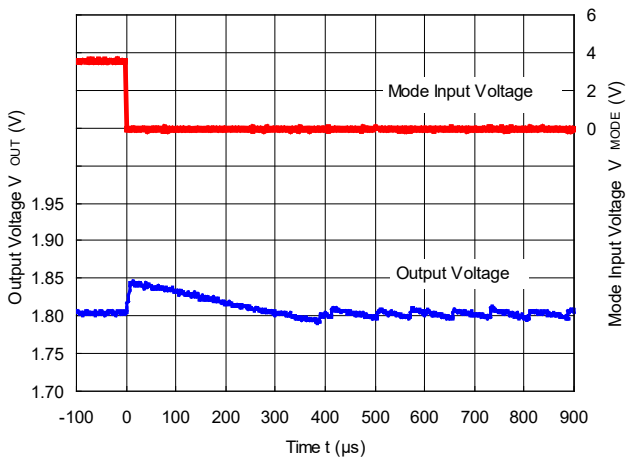

PACKAGE INFORMATION

Power Dissipation (DFN(PL)2730-12)

Power Dissipation (P_D) depends on conditions of mounting on board. This specification is based on the Measurement Conditions below.

Measurement Conditions

	Standard Land Pattern	High Wattage Land Pattern
Environment	Mounting on Board (Wind Velocity=0m/s)	Mounting on Board (Wind Velocity=0m/s)
Board Material	Glass Cloth Epoxy Plastic (Double-sided)	Glass Cloth Epoxy Plastic (Four-layers)
Board Dimensions	40mm x 40mm x 1.6mm	76.2mm x 114.3mm x 1.6mm
Copper Ratio	Top-layer: Approx. 50%, Back-layer: Approx. 50%	Top and Back-layers: Approx. 10%, 2nd, 3rd layers: Approx. 100%
Through-holes	ϕ 0.54mm x 32pcs	ϕ 0.85mm x 64pcs Notes: Pad (Heat spreader), top layer, 2nd layer and 3rd layer are connected by 0.3mm holes drilled in PCBs.

Measurement Conditions

($T_a=25^\circ\text{C}$, $T_{j\text{max}}=125^\circ\text{C}$)

	Standard Land Pattern	High Wattage Land Pattern
Power Dissipation	1000mW	1950mW
Thermal Resistance	$\theta_{ja} = (125-25^\circ\text{C})/1.0\text{W} = 100^\circ\text{C/W}$	$\theta_{ja} = (125-25^\circ\text{C})/1.95\text{W} = 51.2^\circ\text{C/W}$
	$\theta_{jc} = 18^\circ\text{C/W}$	$\theta_{jc} = 5.9^\circ\text{C/W}$

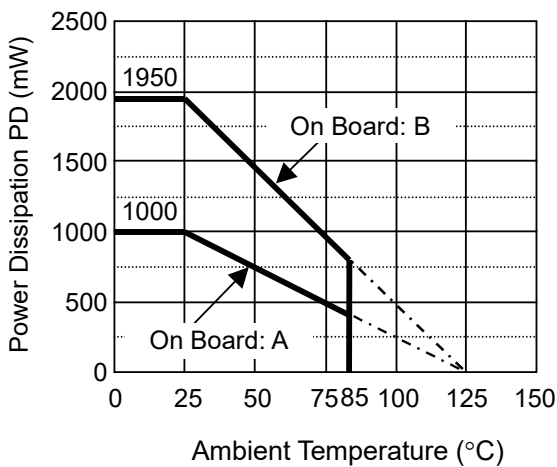

Power Dissipation

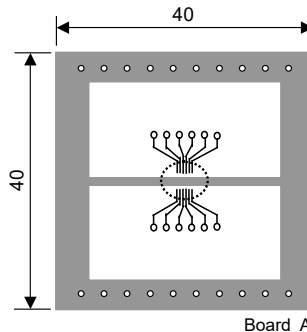

Measurement Board Pattern

○ IC Mount Area (Unit : mm)

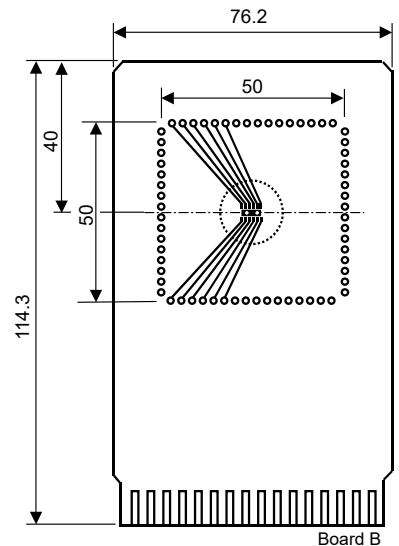

Measurement Board Pattern

○ IC Mount Area (Unit : mm)

Package Dimensions (DFN(PL)2730-12)

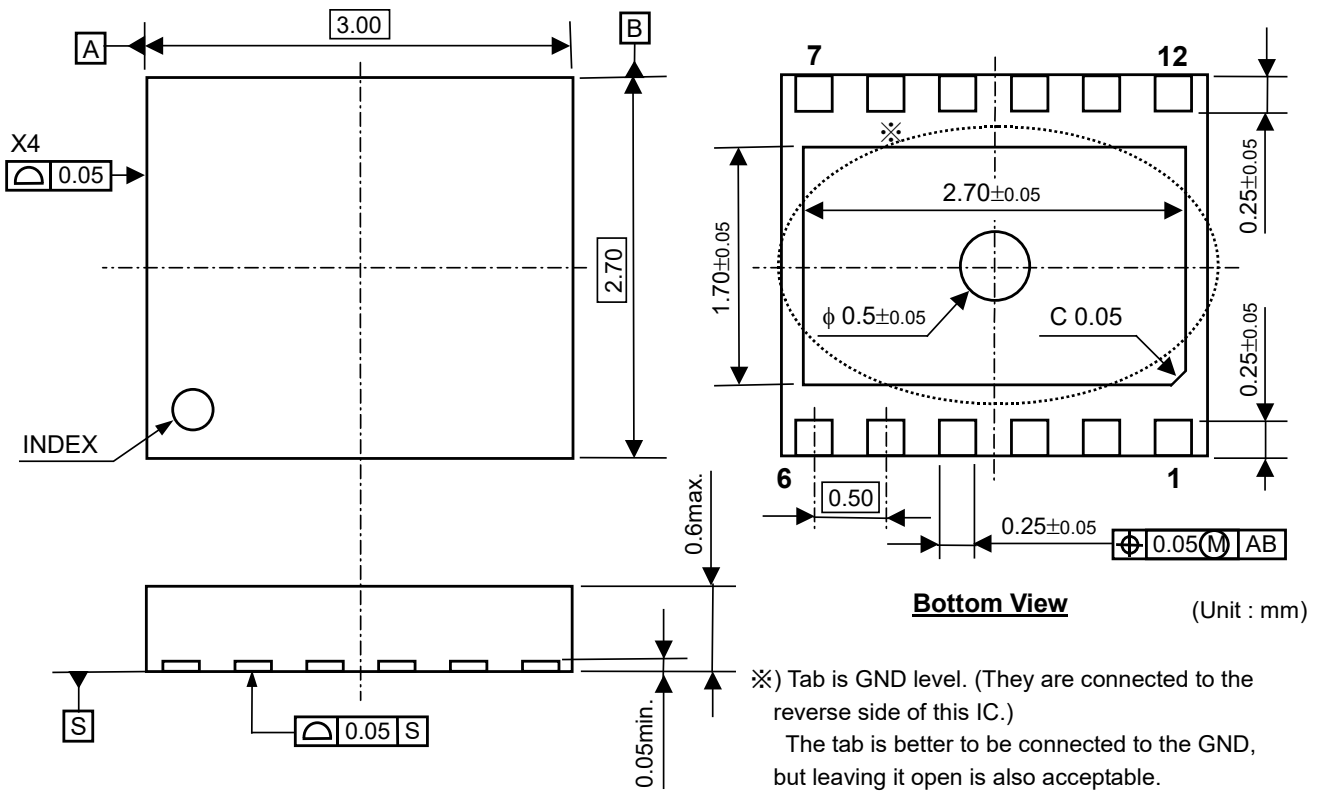

Mark Specification (DFN(PL)2730-12)

- ①②③④: Product Code ... **DT01**
- ⑤⑥: Lot Number ... Alphanumeric Serial Number

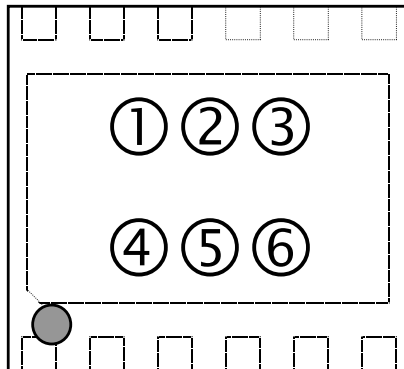



1. The products and the product specifications described in this document are subject to change or discontinuation of production without notice for reasons such as improvement. Therefore, before deciding to use the products, please refer to our sales representatives for the latest information thereon.
2. The materials in this document may not be copied or otherwise reproduced in whole or in part without prior written consent of our company.
3. Please be sure to take any necessary formalities under relevant laws or regulations before exporting or otherwise taking out of your country the products or the technical information described herein.
4. The technical information described in this document shows typical characteristics of and example application circuits for the products. The release of such information is not to be construed as a warranty of or a grant of license under our company's or any third party's intellectual property rights or any other rights.
5. The products listed in this document are intended and designed for use as general electronic components in standard applications (office equipment, telecommunication equipment, measuring instruments, consumer electronic products, amusement equipment etc.). Those customers intending to use a product in an application requiring extreme quality and reliability, for example, in a highly specific application where the failure or misoperation of the product could result in human injury or death (aircraft, spacevehicle, nuclear reactor control system, traffic control system, automotive and transportation equipment, combustion equipment, safety devices, life support system etc.) should first contact us.
6. We are making our continuous effort to improve the quality and reliability of our products, but semiconductor products are likely to fail with certain probability. In order to prevent any injury to persons or damages to property resulting from such failure, customers should be careful enough to incorporate safety measures in their design, such as redundancy feature, fire containment feature and fail-safe feature. We do not assume any liability or responsibility for any loss or damage arising from misuse or inappropriate use of the products.
7. Anti-radiation design is not implemented in the products described in this document.
8. The X-ray exposure can influence functions and characteristics of the products. Confirm the product functions and characteristics in the evaluation stage.
9. WLCSP products should be used in light shielded environments. The light exposure can influence functions and characteristics of the products under operation or storage.
10. There can be variation in the marking when different AOI (Automated Optical Inspection) equipment is used. In the case of recognizing the marking characteristic with AOI, please contact our sales or our distributor before attempting to use AOI.
11. Please contact our sales representatives should you have any questions or comments concerning the products or the technical information.



Nisshinbo Micro Devices Inc.

Official website

<https://www.nisshinbo-microdevices.co.jp/en/>

Purchase information

<https://www.nisshinbo-microdevices.co.jp/en/buy/>

