

Main Product Characteristics

BV_{DSS}	65V
$R_{DS(ON)}$	8.5mΩ
I_D	48A

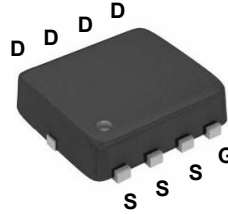

PPAK3x3

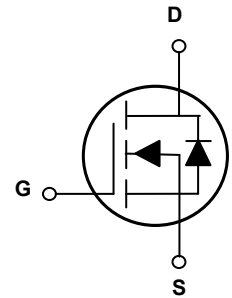

Schematic Diagram

Features and Benefits

- Advanced MOSFET process technology
- Ideal for high efficiency switched mode power supplies
- Low on-resistance with low gate charge
- Fast switching and reverse body recovery



Description

The GSGN0648 utilizes the latest techniques to achieve high cell density and low on-resistance. These features make this device extremely efficient and reliable for use in high efficiency switch mode power supply and a wide variety of other applications.

Absolute Maximum Ratings ($T_C=25^\circ\text{C}$ unless otherwise specified)

Parameter	Symbol	Max.	Unit
Drain-Source Voltage	V_{DS}	65	V
Gate-Source Voltage	V_{GS}	±20	V
Drain Current-Continuous ($T_C=25^\circ\text{C}$); Silicon Limited	I_D	48	A
Drain Current-Continuous ($T_C=100^\circ\text{C}$); Silicon Limited		30.4	
Drain Current-Continuous ($T_C=25^\circ\text{C}$); Package Limited		32	
Drain Current ¹		11	
Drain Current-Pulsed ² ($T_C=25^\circ\text{C}$)	I_{DM}	192	A
Single Pulse Avalanche Energy ³	E_{AS}	45	mJ
Single Pulse Avalanche Current ³	I_{AS}	30	A
Power Dissipation ($T_C=25^\circ\text{C}$)	P_D	42	W
Power Dissipation-Derate above 25°C		0.33	W/°C
Thermal Resistance, Junction-to-Ambient	$R_{\theta JA}$	62	°C/W
Thermal Resistance, Junction-to-Case	$R_{\theta JC}$	2.98	°C/W
Operating Junction Temperature Range	T_J	-55 To +150	°C
Storage Temperature Range	T_{STG}	-55 To +150	°C

Electrical Characteristics ($T_J=25^{\circ}\text{C}$ unless otherwise specified)

Parameter	Symbol	Conditions	Min.	Typ.	Max.	Unit
On / Off Characteristics						
Drain-Source Breakdown Voltage	BV_{DSS}	$V_{GS}=0V, I_D=250\mu A$	65	-	-	V
Drain-Source Leakage Current	I_{DSS}	$V_{DS}=60V, V_{GS}=0V, T_J=25^{\circ}\text{C}$	-	-	1	μA
		$V_{DS}=48V, V_{GS}=0V, T_J=85^{\circ}\text{C}$	-	-	10	μA
Gate-Source Leakage Current	I_{GSS}	$V_{GS}=\pm 20V, V_{DS}=0V$	-	-	± 100	nA
Static Drain-Source On-Resistance ³	$R_{DS(ON)}$	$V_{GS}=10V, I_D=15A$	-	7.1	8.5	m Ω
		$V_{GS}=4.5V, I_D=12A$	-	10.7	13.9	
Gate Threshold Voltage	$V_{GS(th)}$	$V_{GS}=V_{DS}, I_D=250\mu A$	1.2	1.6	2.5	V
Forward Transconductance	g_{fs}	$V_{DS}=10V, I_S=3A$	-	9	-	S
Dynamic and Switching Characteristics						
Total Gate Charge ^{4,5}	Q_g	$V_{DS}=30V, I_D=20A, V_{GS}=10V$	-	16.6	33	nC
Gate-Source Charge ^{4,5}	Q_{gs}		-	1.8	3.6	
Gate-Drain Charge ^{4,5}	Q_{gd}		-	6.5	13.1	
Turn-On Delay Time ^{4,5}	$t_{d(on)}$	$V_{DD}=30V, R_G=6\Omega, V_{GS}=10V, I_D=20A$	-	10	20	nS
Rise Time ^{4,5}	t_r		-	13.5	27	
Turn-Off Delay Time ^{4,5}	$t_{d(off)}$		-	28	56	
Fall Time ^{4,5}	t_f		-	20	40	
Input Capacitance	C_{iss}	$V_{DS}=30V, V_{GS}=0V, F=1\text{MHz}$	-	975	1450	pF
Output Capacitance	C_{oss}		-	280	420	
Reverse Transfer Capacitance	C_{rss}		-	30	50	
Gate Resistance	R_g	$V_{GS}=0V, V_{DS}=0V, F=1\text{MHz}$	-	0.8	-	Ω
Drain-Source Diode Characteristics and Maximum Ratings						
Continuous Source Current	I_S	$V_G=V_D=0V, \text{Force Current}$	-	-	48	A
Pulsed Source Current	I_{SM}		-	-	96	A
Diode Forward Voltage	V_{SD}	$V_{GS}=0V, I_S=1A, T_J=25^{\circ}\text{C}$	-	-	1	V
Reverse Recovery Time	t_{rr}	$V_R=30V, I_S=10A, di/dt=100A/\mu s, T_J=25^{\circ}\text{C}$	-	27	-	nS
Reverse Recovery Charge	Q_{rr}		-	35	-	nC

Note :

1. The value is measured with the device mounted on 1in² FR-4 board with 2oz. Copper
2. Repetitive Rating: Pulsed width limited by maximum junction temperature.
3. $V_{DD}=25V, V_{GS}=10V, L=0.1\text{mH}, I_{AS}=30A, R_G=25\Omega, \text{Starting } T_J=25^{\circ}\text{C}.$
4. Pulse Test: pulse width $\leq 300\mu s$, duty cycle $\leq 2\%$.
5. Essentially independent of operating temperature.

Typical Electrical and Thermal Characteristic Curves

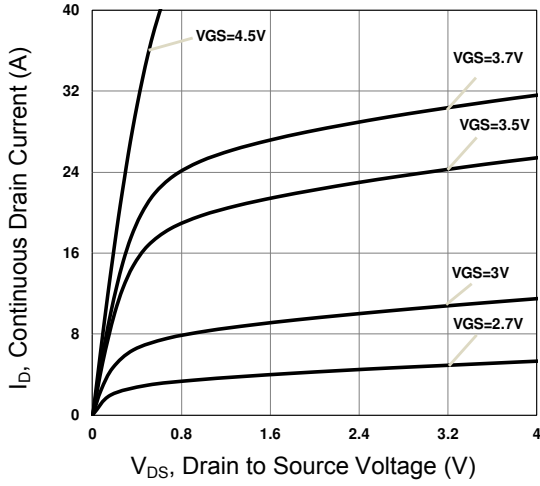

Figure 1. Typical Output Characteristics

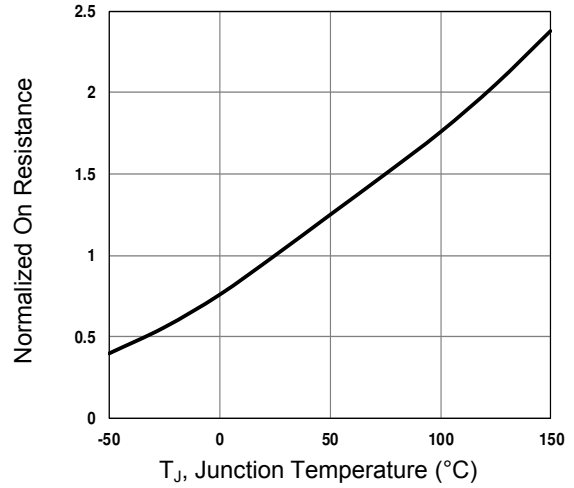

Figure 2. Normalized RDSON vs. T_J

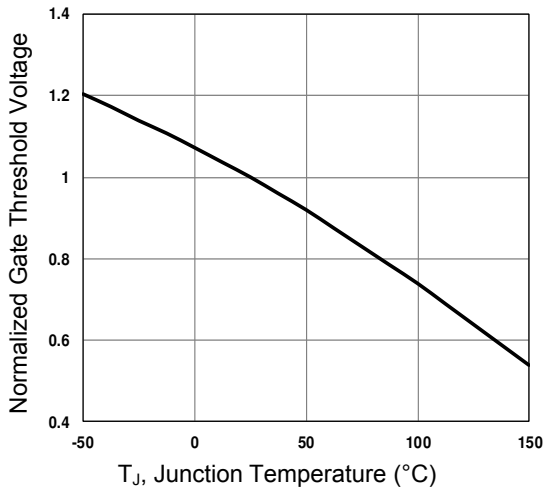

Figure 3. Normalized V_{th} vs. T_J

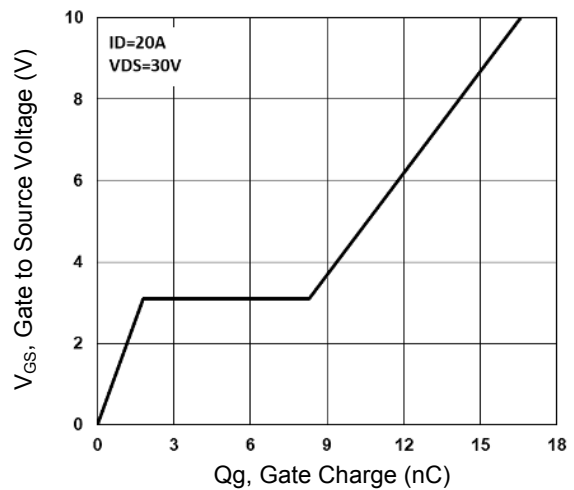

Figure 4. Gate Charge Waveform

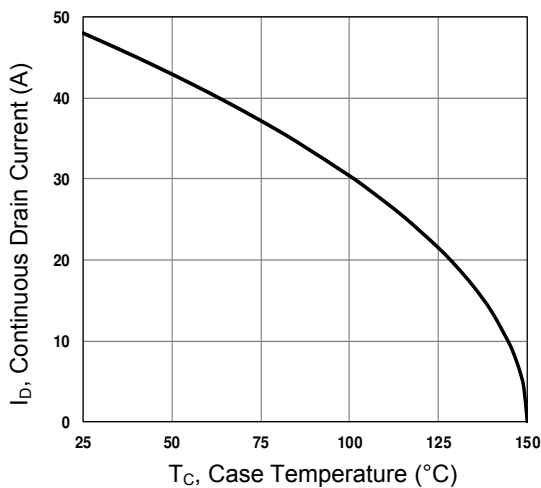

Figure 5. Continuous Drain Current vs. T_C

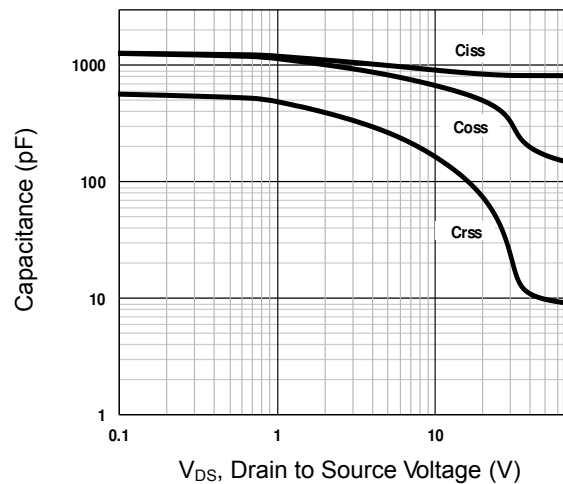

Figure 6. Capacitance Characteristics

Typical Electrical and Thermal Characteristic Curves

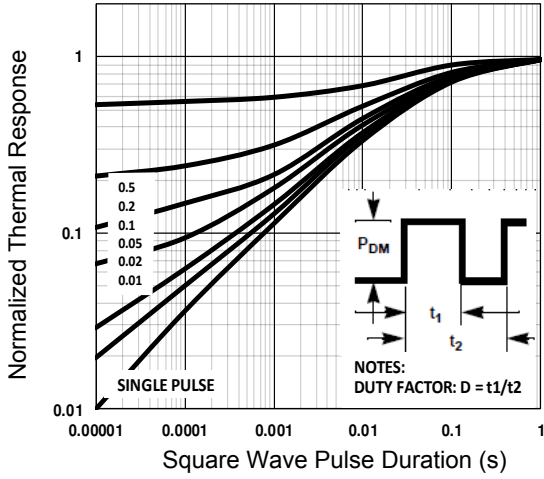

Figure 7. Normalized Transient Impedance

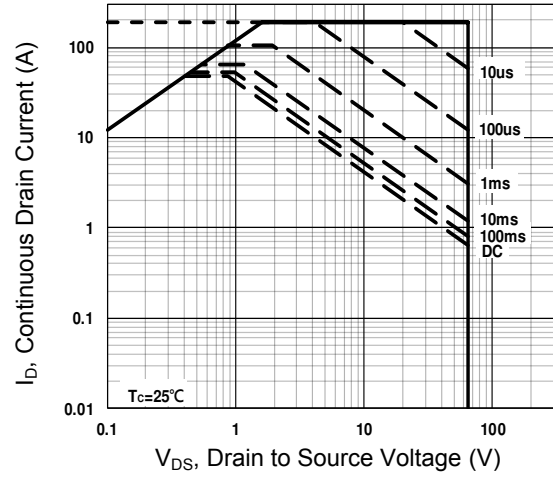

Figure 8. Maximum Safe Operation Area

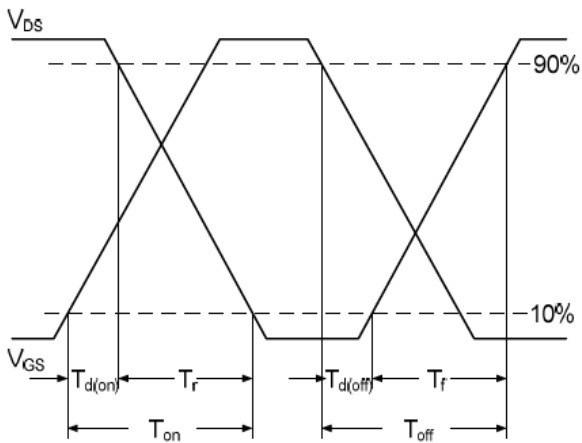

Figure 9. Switching Time Waveform

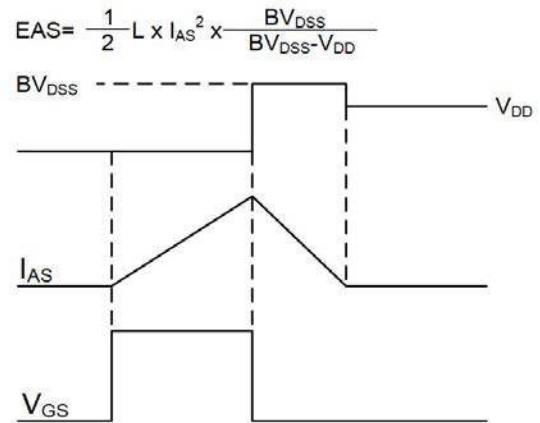
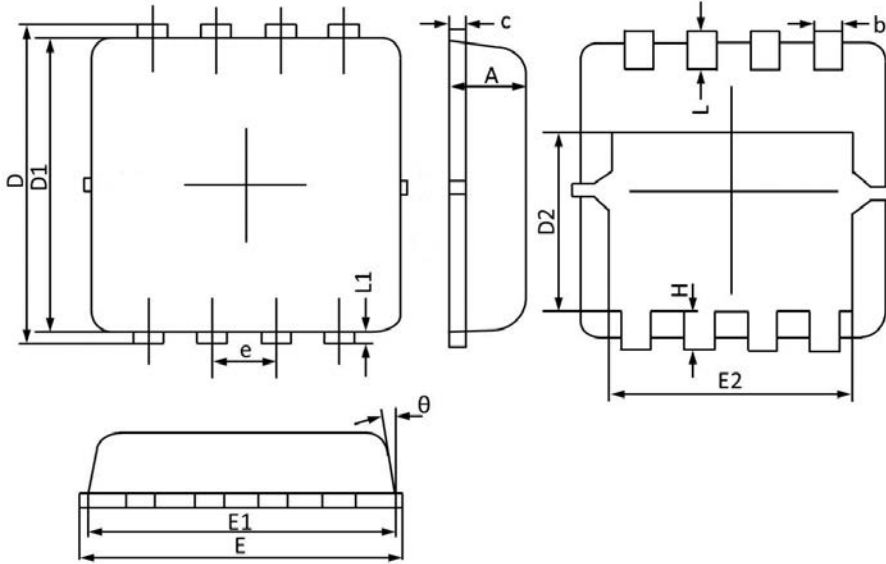

Figure 10. EAS Waveform

Package Outline Dimensions (PPAK 3x3)



Symbol	Dimensions in Millimeters		Dimensions in Inches	
	Max	Min	Max	Min
A	0.900	0.700	0.035	0.028
b	0.350	0.250	0.014	0.010
c	0.250	0.100	0.010	0.004
D	3.500	3.050	0.138	0.120
D1	3.200	2.900	0.126	0.114
D2	1.950	1.350	0.077	0.053
E	3.400	3.000	0.134	0.118
E1	3.300	2.900	0.130	0.114
E2	2.600	2.350	0.102	0.093
e	0.650 BSC		0.026 BSC	
H	0.750	0.300	0.030	0.012
L	0.600	0.300	0.024	0.012
L1	0.200	0.060	0.008	0.002
θ	14°	6°	14°	6°

Recommended Pad Layout

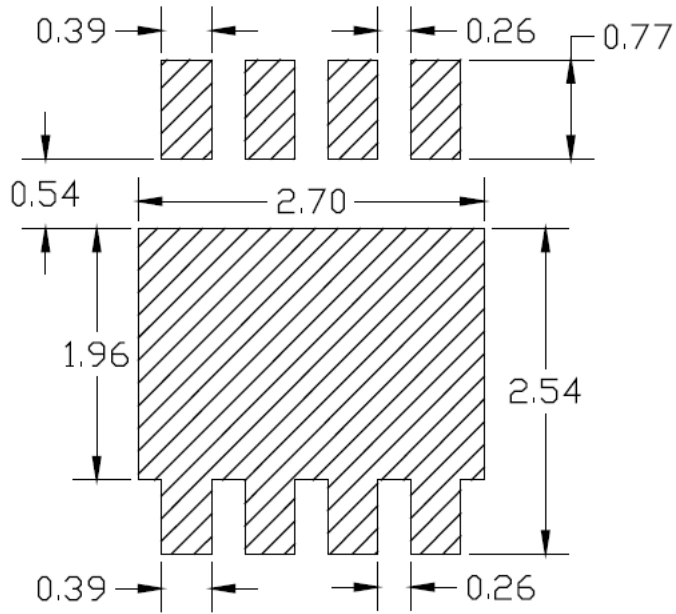

unit : mm