



# UPMOST TECHNOLOGY CORP.

ADD 2F., No.220, Sec. 4, Chengde Rd.,  
Shihlin District, Taipei City 11167,  
Taiwan

TEL +886 2 2883 7222  
FAX +886 2 2883 7145  
URL www.upmostgroup.com

## APPROVAL SHEET

Product : SHI100

Part Number :

Description :

Version :

Date : 11, July, 2017

Customer : 研華股份有限公司

Customer approval seal :



UPMOST approval seal :



Approved by		Approved by	
Checked by		Checked by	
Prepared by		Prepared by	

## Catalogue

1	.....Prductor Drawing
2	.....Cable Spec Drawing
3-13	.....Cable Conductor RoSH Test Report
14-19	.....Cable HDPE RoSH Test Report
20-29	.....Cable AL. Mylar RoSH Test Report
30	.....Cable Spec Drawing
31-34	.....Cable UL
35-39	.....Cable Conductor RoSH Test Report
40-49	.....Cable PVC RoSH Test Report
50-51	.....SATA 7P/LATCH Spec Drawing
52-67	.....SATA 7P/LATCH RoSH Test Report
68-69	.....MINI SAS 36P PCB Spec Drawing
70-244	.....MINI SAS 36P PCB RoSH Test Report
245-274	.....TRL-THERMELT-867/PVC/PE/PP RoSH Test Report
275-276	.....ECI HOUSING/TERMINAL Spec Drawing
277-278	.....ECI HOUSING/TERMINAL UL
279-291	.....ECI HOUSING/TERMINAL RoSH Test Report
292-300	.....TIN RoSH Test Report
301-320	.....TUBE RoSH Test Report
321-329	.....ACETATE TAPE RoSH Test Report
330-334	.....NYLON BRAID RoSH Test Report

4

3

2

1

PART NO.	SHI100
----------	--------

REVISIONS			
LTR	DESCRIPTION	DATE	APPROVED
A0	Initial Release for Manufacture	Apr.23.15	Bryant

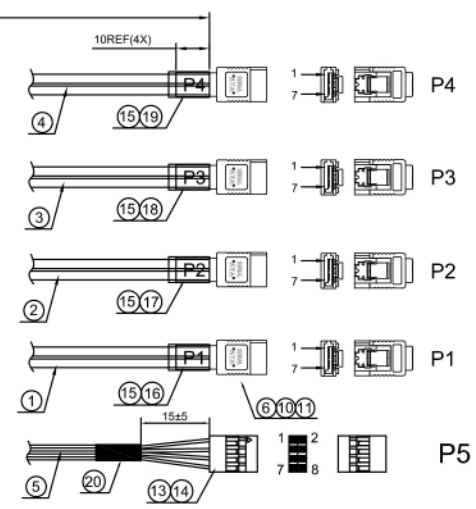
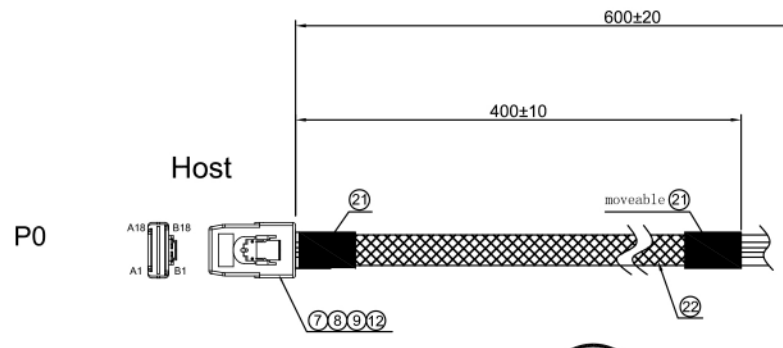

NOTE:  
 1.100% TEST OPEN SHORT  
 2.INSULATION RESISTANCE:10M ohm(MIN)  
 3.CONDUCTOR RESISTANCE:2 ohm (MAX)  
 4.HI POT TEST :300V AC/10ms

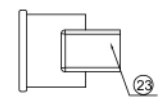

PIN ASSIGNMENT

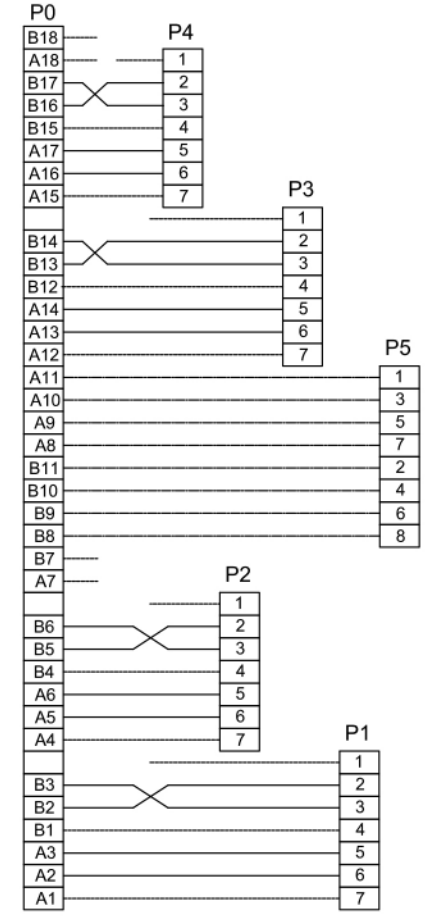

Legend:  
 :High-Speed Serial Differential Pairs  
 :Signal Return  
 :Sideband Signal

23	3-01-0004-003001	PVC 30P MINI SAS 36P DUSTPROOF COVER	7	g
22	4-15-0044-001001	NYLON BRAID W=10.0MM BLACK 1*72	420.0	mm
21	4-20-0062-002001	ACETATE TAPE BLACK W=20mm	50.0*2	mm
20	4-15-0005-200201	Heat shrink tube OD:3.0mm BLACK	15.0	mm
19	4-22-0091-3007P4	LABEL: "P4" Translucent bottom black words	1	PCS
18	4-22-0050-3007P3	LABEL: "P3" Translucent bottom black words	1	PCS
17	4-22-0049-3007P2	LABEL: "P2" Translucent bottom black words	1	PCS
16	4-22-0048-3007P1	LABEL: "P1" Translucent bottom black words	1	PCS
15	4-15-0039-100201	Heat shrink tube OD:5.0mm Transparent	15.0*4	mm
14	4-19-A011-254051	ECI 2563 Terminal Wire:24~26AWG OD:1.2~1.0mm	8	PCS
13	4-19-B061-240801	ECI 2562 2*4P HOUSING PITCH:2.54MM PBT BLACK	1	PCS
12	3-03-0002-005001	PP BK	6	g
11	3-02-0001-532151	PE	10	g
10	3-01-0033-005001	PVC 50P BLACK (UL94V-0)	12	g
9	3-02-0002-086701	TRL-THERMELT-867	12.5	g
8	2-61-A042-011501	LATCH	5	PCS
7	2-70-0001-011501	MINI SAS 36P PCB	1	PCS
6	2-61-A041-011501	SATA 7P/LATCH G/F 180°PBT BK	4	PCS
5	1-58-0022-200209	FLAT CABLE:30#*4C PH 0.8mm GRAY NO-UL	633.0*2	mm
4	1-61-0052-200251	2C*30#+2D+AL-MYLAR+THERMOPLASTIC-MYLAR BLUE 04(Non UL)	630.0*2	mm
3	1-61-0051-200251	2C*30#+2D+AL-MYLAR+THERMOPLASTIC-MYLAR BLUE 03(Non UL)	630.0*2	mm
2	1-61-0050-200251	2C*30#+2D+AL-MYLAR+THERMOPLASTIC-MYLAR BLUE 02(Non UL)	630.0*2	mm
1	1-61-0049-200251	2C*30#+2D+AL-MYLAR+THERMOPLASTIC-MYLAR BLUE 01(Non UL)	630.0*2	mm
NO.	PART NO.	DESCRIPTION	Q'TY	UNIT

登昌恆	APPROVALS	DATE	HD MINI SAS TO 4x SATA 7PLATCH G/F 180°+ 2*4P H.S CABLE 0.6M					
	DRAWN Liang.Zhuquan	Apr.23.15						
	CHECKED Zeng.WeI	Apr.23.15						
DECIMALS X ± 0.30	ANGLES ± 3°	APPROVAL:	APPROVALS	DATE	SIZE C	SCALE XX : XX	DRAWING NO.	REV. A0
DO NOT SCALE DRAWING		Zeng.WeI	Apr.23.15		ID NO.			SHEET 1 OF 1

4

3

2

1

# 東莞德宏電線電子有限公司

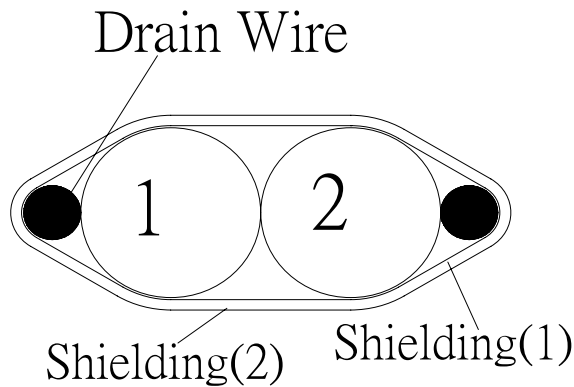

**Color Code**

- 1.White
- 2.White

ITEM		DESCRIPTION
No. Of Core		(2 Cores + 2 Drain+Shield+Shield)
Conductor	Material	30AWG ; Solid Tinned Copper
	Construction	1 Solid / 0.26T ± 0.008 mm
Insulation	Material	HDPE
	Thickness	0.27 mm
	Diameter	0.80 ± 0.05 mm
Drain Wire	Material	Solid Tinned Copper
	Construction	30AWG ; 1 Solid / 0.26T <b>(2 Pcs)</b>
Shielding(1)	Material	Hot melt Aluminum Mylar Spirally Wrapped
	Construction	100% coverage with 25% overlapping
	Marking	#30 #01.....;#30 #02.....;#30 #03.....;#30 #04.....;#30 #05.....;#30 #06.....;#30 #07.....;#30 #08.....
Shielding(2)	Material	Hot melt Transparent Mylar Spirally Wrapped
	Construction	100% coverage with 25% overlapping
	Nom. Diameter	1.0×2.32± 0.20 mm

**ELECTRICAL PROPERTIES**

Conductor Resistance	Max. 376 ohms/km at 20°C
Insulation Resistance	Min. 10 mega ohms-km at 20°C
Dielectric Test	500 VAC /1 min ; No Breakdown
Impedance	100 ± 5 ohms
Intra pair skew	15 ps/m

DRWN.	chris	SPEC NO.:	<b>Construction:</b>  30AWG x 2 C +2D+HMAM+ HM
CHKD.		<b>H19809DP</b>	
APPD.		Sample:Sa08183-1	
		DATE: Dec.-29-2008	



## Test Report

No. CANEC1505923503

Date: 30 Apr 2015

Page 1 of 11

HOPERISE CONDUCTOR(DONGGUAN) COMPANY LIMITED

QIAO ZI REGION CHANGPING TOWN,DONGGUAN CITY,GUANGDONG PROVINCE  
CHINA

The following sample(s) was/were submitted and identified on behalf of the clients as : TINNED COPPER WIRE

SGS Job No. : CP15-020403 - GZ

Client Ref. Info. : Sample Description:silvery plating on metal

Material:Base material Cu

Sample Description:silver color plating

Date of Sample Received : 17 Apr 2015

Testing Period : 17 Apr 2015 - 23 Apr 2015

Test Requested : Selected test(s) as requested by client.

Test Method : Please refer to next page(s).

Test Results : Please refer to next page(s).

Conclusion : Based on the performed tests on submitted sample(s), the results of Lead, Mercury, Cadmium, Hexavalent chromium, Polybrominated biphenyls (PBBs), Polybrominated diphenyl ethers (PBDEs) comply with the limits as set by RoHS Directive 2011/65/EU Annex II; recasting 2002/95/EC.

Signed for and on behalf of  
SGS-CSTC Standards Technical Services Co., Ltd. Guangzhou Branch



Merry Lv  
Approved Signatory



This document is issued by the Company subject to its General Conditions of Service printed overleaf, available on request or accessible at <http://www.sgs.com/en/Terms-and-Conditions.aspx> and, for electronic format documents, subject to Terms and Conditions for Electronic Documents at <http://www.sgs.com/en/Terms-and-Conditions/Terms-e-Documents.aspx>. Attention is drawn to the limitation of liability, indemnification and jurisdiction issues defined therein. Any holder of this document is advised that information contained hereon reflects the Company's findings at the time of its intervention only and within the limits of Client's instructions, if any. The Company's sole responsibility is to its Client and this document does not exonerate parties to a transaction from exercising all their rights and obligations under the transaction documents. This document cannot be reproduced except in full, without prior written approval of the Company. Any unauthorized alteration, forgery or falsification of the content or appearance of this document is unlawful and offenders may be prosecuted to the fullest extent of the law. Unless otherwise stated the results shown in this test report refer only to the sample(s) tested.  
**Attention: To check the authenticity of testing /inspection report & certificate, please contact us at telephone: (86-755) 8307 1443, or email: CN.Doccheck@sgs.com**

198 Kezhu Road, Sciencetech Park Guangzhou Economic & Technology Development District, Guangzhou, China 510663 t (86-20) 82155555 f (86-20) 82075113 www.sgsgroup.com.cn  
中国·广州·经济技术开发区科学城科珠路198号 邮编: 510663 t (86-20) 82155555 f (86-20) 82075113 e sgs.china@sgs.com

# Test Report

No. CANEC1505923503

Date: 30 Apr 2015

Page 2 of 11

Test Results :

Test Part Description :

Specimen No.	SGS Sample ID	Description
SN1	CAN15-059235.002	Silvery plated metal

Remarks :

- (1) 1 mg/kg = 1 ppm = 0.0001%
- (2) MDL = Method Detection Limit
- (3) ND = Not Detected ( < MDL )
- (4) "-" = Not Regulated

**RoHS Directive 2011/65/EU**

- Test Method :
- (1)With reference to IEC 62321-5:2013, determination of Cadmium by ICP-OES.
  - (2)With reference to IEC 62321-5:2013, determination of Lead by ICP-OES.
  - (3)With reference to IEC 62321-4:2013, determination of Mercury by ICP-OES.
  - (4)With reference to IEC 62321:2008, determination of Hexavalent Chromium by spot test / Colorimetric Method using UV-Vis.
  - (5)With reference to IEC 62321:2008, determination of PBBs and PBDEs by GC-MS.

<u>Test Item(s)</u>	<u>Limit</u>	<u>Unit</u>	<u>MDL</u>	<u>002</u>
Cadmium (Cd)	100	mg/kg	2	ND
Lead (Pb)	1,000	mg/kg	2	5
Mercury (Hg)	1,000	mg/kg	2	ND
Hexavalent Chromium (CrVI)	-	-	◇	Negative
Sum of PBBs	1,000	mg/kg	-	ND
Monobromobiphenyl	-	mg/kg	5	ND
Dibromobiphenyl	-	mg/kg	5	ND
Tribromobiphenyl	-	mg/kg	5	ND
Tetrabromobiphenyl	-	mg/kg	5	ND
Pentabromobiphenyl	-	mg/kg	5	ND
Hexabromobiphenyl	-	mg/kg	5	ND
Heptabromobiphenyl	-	mg/kg	5	ND
Octabromobiphenyl	-	mg/kg	5	ND
Nonabromobiphenyl	-	mg/kg	5	ND
Decabromobiphenyl	-	mg/kg	5	ND
Sum of PBDEs	1,000	mg/kg	-	ND
Monobromodiphenyl ether	-	mg/kg	5	ND



This document is issued by the Company subject to its General Conditions of Service printed overleaf, available on request or accessible at <http://www.sgs.com/en/Terms-and-Conditions.aspx> and, for electronic format documents, subject to Terms and Conditions for Electronic Documents at <http://www.sgs.com/en/Terms-and-Conditions/Terms-e-Documents.aspx>. Attention is drawn to the limitation of liability, indemnification and jurisdiction issues defined therein. Any holder of this document is advised that information contained hereon reflects the Company's findings at the time of its intervention only and within the limits of Client's instructions, if any. The Company's sole responsibility is to its Client and this document does not exonerate parties to a transaction from exercising all their rights and obligations under the transaction documents. This document cannot be reproduced except in full, without prior written approval of the Company. Any unauthorized alteration, forgery or falsification of the content or appearance of this document is unlawful and offenders may be prosecuted to the fullest extent of the law. Unless otherwise stated the results shown in this test report refer only to the sample(s) tested.

Attention: To check the authenticity of testing /inspection report & certificate, please contact us at telephone: (86-755) 8307 1443, or email: CN.Doccheck@sgs.com

198 Kezhu Road, Sciencetech Park Guangzhou Economic & Technology Development District, Guangzhou, China 510663 t (86-20) 82155555 f (86-20) 82075113 www.sgsgroup.com.cn  
中国·广州·经济技术开发区科学城科珠路198号 邮编: 510663 t (86-20) 82155555 f (86-20) 82075113 e sgs.china@sgs.com

## Test Report

No. CANEC1505923503

Date: 30 Apr 2015

Page 3 of 11

<u>Test Item(s)</u>	<u>Limit</u>	<u>Unit</u>	<u>MDL</u>	<u>002</u>
Dibromodiphenyl ether	-	mg/kg	5	ND
Tribromodiphenyl ether	-	mg/kg	5	ND
Tetrabromodiphenyl ether	-	mg/kg	5	ND
Pentabromodiphenyl ether	-	mg/kg	5	ND
Hexabromodiphenyl ether	-	mg/kg	5	ND
Heptabromodiphenyl ether	-	mg/kg	5	ND
Octabromodiphenyl ether	-	mg/kg	5	ND
Nonabromodiphenyl ether	-	mg/kg	5	ND
Decabromodiphenyl ether	-	mg/kg	5	ND

### Notes :

(1) The maximum permissible limit is quoted from the directive 2011/65/EU, Annex II.

(2)◇Spot-test:

Negative = Absence of CrVI coating, Positive = Presence of CrVI coating;

(The tested sample should be further verified by boiling-water-extraction method if the spot test result is Negative or cannot be confirmed.)

◇Boiling-water-extraction:

Negative = Absence of CrVI coating

Positive = Presence of CrVI coating; the detected concentration in boiling-water-extraction solution is equal or greater than 0.02 mg/kg with 50 cm<sup>2</sup> sample surface area.

Information on storage conditions and production date of the tested sample is unavailable and thus results of Cr(VI) represent status of the sample at the time of testing.

### Elementary Analysis

Test Method : With reference to US EPA method 3050B:1996,analysis was performed by ICP-OES.

<u>Test Item(s)</u>	<u>Unit</u>	<u>MDL</u>	<u>002</u>
Beryllium (Be)	mg/kg	5	ND

### Polycyclic Aromatic Hydrocarbons (PAHs)

Test Method : With reference to AfPS GS 2014:01 PAK, analysis was performed by GC-MS.

<u>Test Item(s)</u>	<u>CAS NO.</u>	<u>Unit</u>	<u>MDL</u>	<u>002</u>
Naphthalene(NAP)	91-20-3	mg/kg	0.1	ND
Acenaphthylene(ANY)	208-96-8	mg/kg	0.1	ND



This document is issued by the Company subject to its General Conditions of Service printed overleaf, available on request or accessible at <http://www.sgs.com/en/Terms-and-Conditions.aspx> and, for electronic format documents, subject to Terms and Conditions for Electronic Documents at <http://www.sgs.com/en/Terms-and-Conditions/Terms-e-Documents.aspx>. Attention is drawn to the limitation of liability, indemnification and jurisdiction issues defined therein. Any holder of this document is advised that information contained hereon reflects the Company's findings at the time of its intervention only and within the limits of Client's instructions, if any. The Company's sole responsibility is to its Client and this document does not exonerate parties to a transaction from exercising all their rights and obligations under the transaction documents. This document cannot be reproduced except in full, without prior written approval of the Company. Any unauthorized alteration, forgery or falsification of the content or appearance of this document is unlawful and offenders may be prosecuted to the fullest extent of the law. Unless otherwise stated the results shown in this test report refer only to the sample(s) tested.

Attention: To check the authenticity of testing /inspection report & certificate, please contact us at telephone: (86-755) 8307 1443, or email: CN.Doccheck@sgs.com

SGS-CTI Standards Technical Services Co., Ltd.  
Guangzhou Economic & Technology Development District, Guangzhou, China

198 Kezhu Road, Scientech Park Guangzhou Economic & Technology Development District, Guangzhou, China 510663 t (86-20) 82155555 f (86-20) 82075113 www.sgsgroup.com.cn  
中国·广州·经济技术开发区科学城科珠路198号 邮编: 510663 t (86-20) 82155555 f (86-20) 82075113 e sgs.china@sgs.com

# Test Report

No. CANEC1505923503

Date: 30 Apr 2015

Page 4 of 11

<u>Test Item(s)</u>	<u>CAS NO.</u>	<u>Unit</u>	<u>MDL</u>	<u>002</u>
Acenaphthene(ANA)	83-32-9	mg/kg	0.1	ND
Fluorene(FLU)	86-73-7	mg/kg	0.1	ND
Phenanthrene(PHE)	85-01-8	mg/kg	0.1	ND
Anthracene(ANT)	120-12-7	mg/kg	0.1	ND
Fluoranthene(FLT)	206-44-0	mg/kg	0.1	ND
Pyrene(PYR)	129-00-0	mg/kg	0.1	ND
Benzo(a)anthracene(BaA)	56-55-3	mg/kg	0.1	ND
Chrysene(CHR)	218-01-9	mg/kg	0.1	ND
Benzo(b)fluoranthene(BbF)	205-99-2	mg/kg	0.1	ND
Benzo(j)fluoranthene(BjF)	205-82-3	mg/kg	0.1	ND
Benzo(k)fluoranthene(BkF)	207-08-9	mg/kg	0.1	ND
Benzo(a)pyrene(BaP)	50-32-8	mg/kg	0.1	ND
Benzo(e)pyrene(BeP)	192-97-2	mg/kg	0.1	ND
Indeno(1,2,3-c,d)pyrene(IPY)	193-39-5	mg/kg	0.1	ND
Dibenzo(a,h)anthracene(DBA)	53-70-3	mg/kg	0.1	ND
Benzo(g,h,i)perylene(BPE)	191-24-2	mg/kg	0.1	ND
Sum of Acenaphthylene, Acenaphthene, Fluorene, Phenanthrene, Pyrene, Anthracene, Fluoranthene	-	mg/kg	-	ND
Sum of 18 PAHs	-	mg/kg	-	ND



This document is issued by the Company subject to its General Conditions of Service printed overleaf, available on request or accessible at <http://www.sgs.com/en/Terms-and-Conditions.aspx> and, for electronic format documents, subject to Terms and Conditions for Electronic Documents at <http://www.sgs.com/en/Terms-and-Conditions/Terms-e-Documents.aspx>. Attention is drawn to the limitation of liability, indemnification and jurisdiction issues defined therein. Any holder of this document is advised that information contained hereon reflects the Company's findings at the time of its intervention only and within the limits of Client's instructions, if any. The Company's sole responsibility is to its Client and this document does not exonerate parties to a transaction from exercising all their rights and obligations under the transaction documents. This document cannot be reproduced except in full, without prior written approval of the Company. Any unauthorized alteration, forgery or falsification of the content or appearance of this document is unlawful and offenders may be prosecuted to the fullest extent of the law. Unless otherwise stated the results shown in this test report refer only to the sample(s) tested.

Attention: To check the authenticity of testing / inspection report & certificate, please contact us at telephone: (86-755) 8307 1443, or email: CN.Doccheck@sgs.com



**AfPS ( German commission for Product Safety ) : GS PAHs requirements**

Parameter	Category 1 Material indented to be put in the mouth or toys with intended skin contact (longer than 30 s).	Category 2		Category 3	
		Toy under 2009/48/EC	Other products under ProdSG	Toy under 2009/48/EC	Other products under ProdSG
Benzo(a)pyrene mg/kg	< 0.2	< 0.2	< 0.5	< 0.5	< 1
Benzo(e)pyrene Mg/kg	< 0.2	< 0.2	< 0.5	< 0.5	< 1
Benzo(a)anthracene mg/kg	< 0.2	< 0.2	< 0.5	< 0.5	< 1
Benzo(b)fluoranthene mg/kg	< 0.2	< 0.2	< 0.5	< 0.5	< 1
Benzo(j)fluoranthene mg/kg	< 0.2	< 0.2	< 0.5	< 0.5	< 1
Benzo(k)fluoranthene mg/kg	< 0.2	< 0.2	< 0.5	< 0.5	< 1
Chrysene mg/kg	< 0.2	< 0.2	< 0.5	< 0.5	< 1
Dibenzo(a,h)anthracene mg/kg	< 0.2	< 0.2	< 0.5	< 0.5	< 1
Benzo(g,h,i)perylene mg/kg	< 0.2	< 0.2	< 0.5	< 0.5	< 1
Indeno(1,2,3-cd)pyrene mg/kg	< 0.2	< 0.2	< 0.5	< 0.5	< 1
Acenaphthylene, Acenaphthene, fluorene, phenanthrene , pyrene, anthracene, fluoranthene, mg/kg	< 1 Sum	< 5 Sum	< 10 Sum	< 20 Sum	< 50 Sum
Naphthalene, mg/kg	< 1	< 2		< 10	
Sum of 18 PAHs	<1	< 5	< 10	< 20	< 50

**Remark:**

The German committee on Product Safety (AfPS) adopted a new PAHs document on August 4, 2014, which is taken into account by the GS certification bodies for the certification process of the GS mark now. The transitional arrangements and deadlines contained therein shall determine the procedure for existing certificates and new certificates; also there are exceptions. The previously valid PAK-document (ZEK 01.4-08, English version) will be repealed after 30th of June.2015.

**Perfluorooctane Sulfonates ( PFOS)**



This document is issued by the Company subject to its General Conditions of Service printed overleaf, available on request or accessible at <http://www.sgs.com/en/Terms-and-Conditions.aspx> and, for electronic format documents, subject to Terms and Conditions for Electronic Documents at <http://www.sgs.com/en/Terms-and-Conditions/Terms-e-Documents.aspx>. Attention is drawn to the limitation of liability, indemnification and jurisdiction issues defined therein. Any holder of this document is advised that information contained hereon reflects the Company's findings at the time of its intervention only and within the limits of Client's instructions, if any. The Company's sole responsibility is to its Client and this document does not exonerate parties to a transaction from exercising all their rights and obligations under the transaction documents. This document cannot be reproduced except in full, without prior written approval of the Company. Any unauthorized alteration, forgery or falsification of the content or appearance of this document is unlawful and offenders may be prosecuted to the fullest extent of the law. Unless otherwise stated the results shown in this test report refer only to the sample(s) tested.

Attention: To check the authenticity of testing /inspection report & certificate, please contact us at telephone: (86-755) 8307 1443, or email: CN.Doccheck@sgs.com

SGS-CTD Standards Technical Services Co., Ltd.  
Guangzhou Chemical Laboratory

198 Kezhu Road, Sciencetech Park Guangzhou Economic & Technology Development District, Guangzhou, China 510663 t (86-20) 82155555 f (86-20) 82075113 www.sgs.com.cn  
中国·广州·经济技术开发区科学城科珠路198号 邮编: 510663 t (86-20) 82155555 f (86-20) 82075113 e sgs.china@sgs.com

# Test Report

No. CANEC1505923503

Date: 30 Apr 2015

Page 6 of 11

Test Method : With reference to US EPA 3550C: 2007, analysis was performed by HPLC-MS.

<u>Test Item(s)</u>	<u>CAS NO.</u>	<u>Unit</u>	<u>MDL</u>	<u>002</u>
Perfluorooctane Sulfonates (PFOS) and related Acid, Metal Salt and Amide	1763-23-1	µg/m <sup>2</sup>	1.0	ND

### Notes :

- For reference: commission regulation (EU) No 757/2010 amending regulation (EC) No 850/2004:
- (1) For the purposes of this entry, Article 4(1) (b) shall apply to concentrations of PFOS equal to or below 10 mg/kg (0,001 % by weight) when it occurs in substances or in preparations.
  - (2) For the purposes of this entry, Article 4(1) (b) shall apply to concentrations of PFOS in semi-finished products or articles, or parts thereof, if the concentration of PFOS is lower than 0,1 % by weight calculated with reference to the mass of structurally or micro-structurally distinct parts that contain PFOS or, for textiles or other coated materials, if the amount of PFOS is lower than 1µg /m2 of the coated material.



This document is issued by the Company subject to its General Conditions of Service printed overleaf, available on request or accessible at <http://www.sgs.com/en/Terms-and-Conditions.aspx> and, for electronic format documents, subject to Terms and Conditions for Electronic Documents at <http://www.sgs.com/en/Terms-and-Conditions/Terms-e-Documents.aspx>. Attention is drawn to the limitation of liability, indemnification and jurisdiction issues defined therein. Any holder of this document is advised that information contained hereon reflects the Company's findings at the time of its intervention only and within the limits of Client's instructions, if any. The Company's sole responsibility is to its Client and this document does not exonerate parties to a transaction from exercising all their rights and obligations under the transaction documents. This document cannot be reproduced except in full, without prior written approval of the Company. Any unauthorized alteration, forgery or falsification of the content or appearance of this document is unlawful and offenders may be prosecuted to the fullest extent of the law. Unless otherwise stated the results shown in this test report refer only to the sample(s) tested.

Attention: To check the authenticity of testing /inspection report & certificate, please contact us at telephone: (86-755) 8307 1443, or email: [CN.Doccheck@sgs.com](mailto:CN.Doccheck@sgs.com)

SGS-CTD Standards Technical Services Co., Ltd.  
Guangzhou Chemical Laboratory

198 Kezhu Road, Sciencetech Park Guangzhou Economic & Technology Development District, Guangzhou, China 510663 t (86-20) 82155555 f (86-20) 82075113 www.sgsgroup.com.cn  
中国·广州·经济技术开发区科学城科珠路198号 邮编: 510663 t (86-20) 82155555 f (86-20) 82075113 e [sgs.china@sgs.com](mailto:sgs.china@sgs.com)

ATTACHMENTS

RoHS Testing Flow Chart

- 1) Name of the person who made testing: Bruce Xiao / Sunny Hu
- 2) Name of the person in charge of testing: Bella Wang / Cutey Yu
- 3) These samples were dissolved totally by pre-conditioning method according to below flow chart (Cr<sup>6+</sup> and PBBs/PBDEs test method excluded).

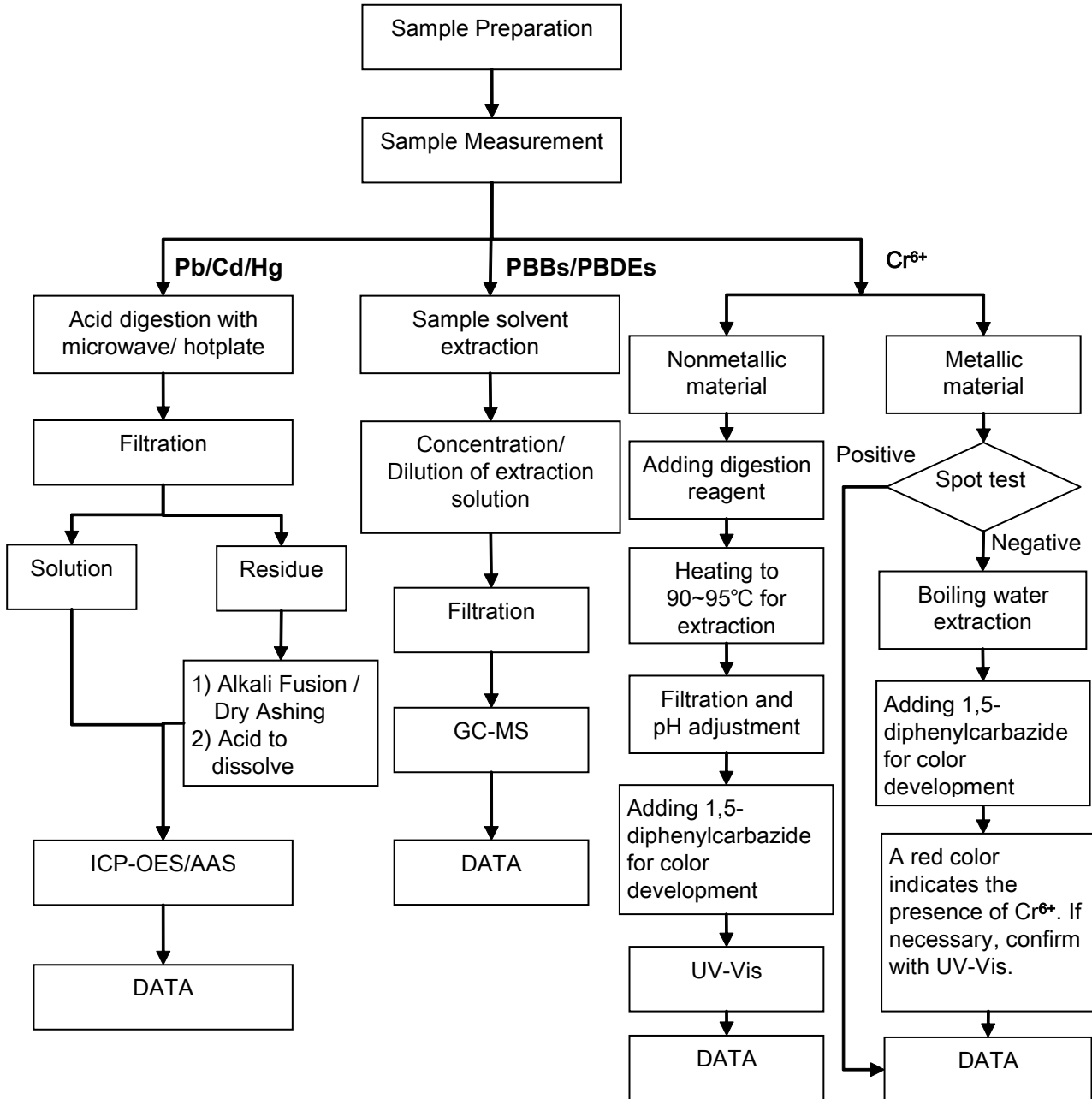

This document is issued by the Company subject to its General Conditions of Service printed overleaf, available on request or accessible at <http://www.sgs.com/en/Terms-and-Conditions.aspx> and, for electronic format documents, subject to Terms and Conditions for Electronic Documents at <http://www.sgs.com/en/Terms-and-Conditions/Terms-e-Documents.aspx>. Attention is drawn to the limitation of liability, indemnification and jurisdiction issues defined therein. Any holder of this document is advised that information contained hereon reflects the Company's findings at the time of its intervention only and within the limits of Client's instructions, if any. The Company's sole responsibility is to its Client and this document does not exonerate parties to a transaction from exercising all their rights and obligations under the transaction documents. This document cannot be reproduced except in full, without prior written approval of the Company. Any unauthorized alteration, forgery or falsification of the content or appearance of this document is unlawful and offenders may be prosecuted to the fullest extent of the law. Unless otherwise stated the results shown in this test report refer only to the sample(s) tested.

Attention: To check the authenticity of testing / inspection report & certificate, please contact us at telephone: (86-755) 8307 1443, or email: CN.Doccheck@sgs.com

198 Kezhu Road, Sciencetech Park Guangzhou Economic & Technology Development District, Guangzhou, China 510663 t (86-20) 82155555 f (86-20) 82075113 www.sgsgroup.com.cn  
 中国·广州·经济技术开发区科学城科珠路198号 邮编: 510663 t (86-20) 82155555 f (86-20) 82075113 e sgs.china@sgs.com

ATTACHMENTS

PFOA / PFOS Testing Flow Chart

- 1) Name of the person who made testing: Zhihong Wang
- 2) Name of the person in charge of testing: Cutey Yu

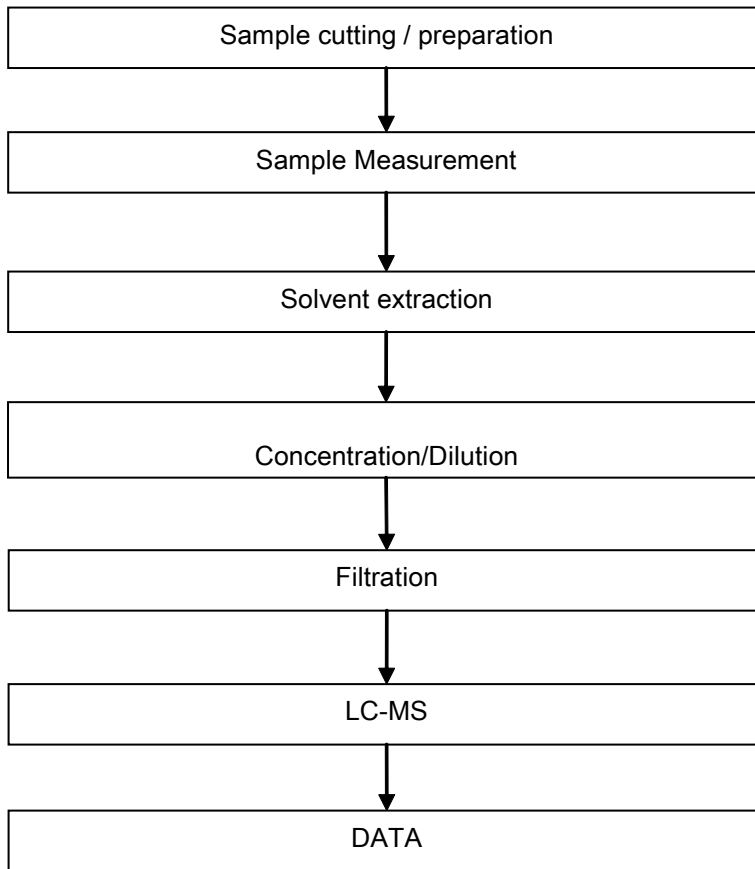

This document is issued by the Company subject to its General Conditions of Service printed overleaf, available on request or accessible at <http://www.sgs.com/en/Terms-and-Conditions.aspx> and, for electronic format documents, subject to Terms and Conditions for Electronic Documents at <http://www.sgs.com/en/Terms-and-Conditions/Terms-e-Document.aspx>. Attention is drawn to the limitation of liability, indemnification and jurisdiction issues defined therein. Any holder of this document is advised that information contained hereon reflects the Company's findings at the time of its intervention only and within the limits of Client's instructions, if any. The Company's sole responsibility is to its Client and this document does not exonerate parties to a transaction from exercising all their rights and obligations under the transaction documents. This document cannot be reproduced except in full, without prior written approval of the Company. Any unauthorized alteration, forgery or falsification of the content or appearance of this document is unlawful and offenders may be prosecuted to the fullest extent of the law. Unless otherwise stated the results shown in this test report refer only to the sample(s) tested.

Attention: To check the authenticity of testing / inspection report & certificate, please contact us at telephone: (86-755) 8307 1443, or email: [CN.Doccheck@sgs.com](mailto:CN.Doccheck@sgs.com)

198 Kezhu Road, Sciencetech Park Guangzhou Economic & Technology Development District, Guangzhou, China 510663 t (86-20) 82155555 f (86-20) 82075113 www.sgsgroup.com.cn  
 中国·广州·经济技术开发区科学城科珠路198号 邮编: 510663 t (86-20) 82155555 f (86-20) 82075113 e [sgs.china@sgs.com](mailto:sgs.china@sgs.com)



ATTACHMENTS

PAHs Testing Flow Chart

- 1) Name of the person who made testing: Sunny Hu
- 2) Name of the person in charge of testing: Cutey Yu

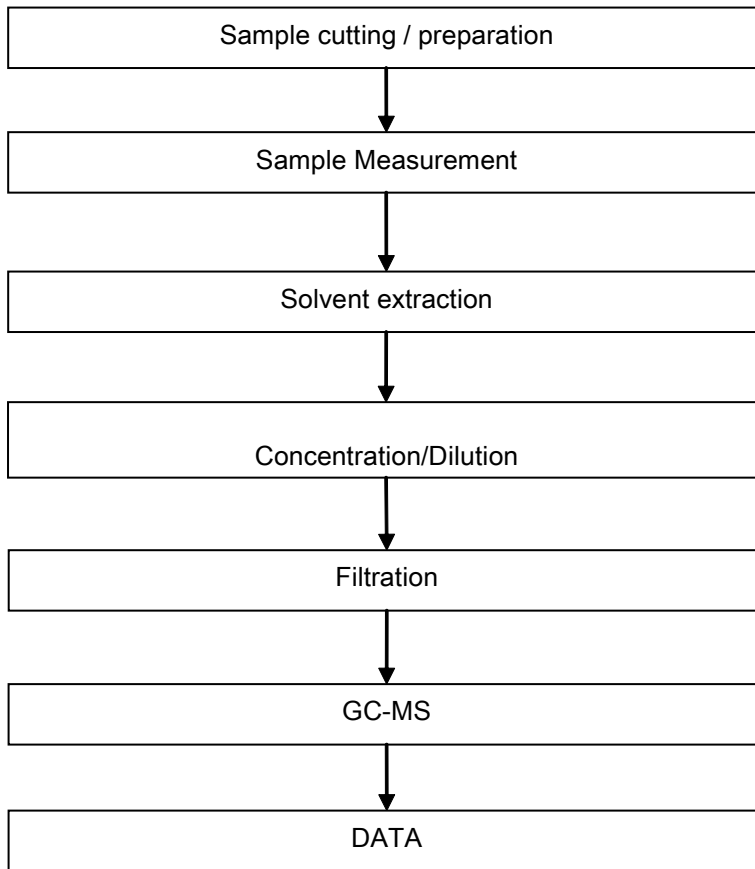

This document is issued by the Company subject to its General Conditions of Service printed overleaf, available on request or accessible at <http://www.sgs.com/en/Terms-and-Conditions.aspx> and, for electronic format documents, subject to Terms and Conditions for Electronic Documents at <http://www.sgs.com/en/Terms-and-Conditions/Terms-e-Documents.aspx>. Attention is drawn to the limitation of liability, indemnification and jurisdiction issues defined therein. Any holder of this document is advised that information contained hereon reflects the Company's findings at the time of its intervention only and within the limits of Client's instructions, if any. The Company's sole responsibility is to its Client and this document does not exonerate parties to a transaction from exercising all their rights and obligations under the transaction documents. This document cannot be reproduced except in full, without prior written approval of the Company. Any unauthorized alteration, forgery or falsification of the content or appearance of this document is unlawful and offenders may be prosecuted to the fullest extent of the law. Unless otherwise stated the results shown in this test report refer only to the sample(s) tested.

Attention: To check the authenticity of testing / inspection report & certificate, please contact us at telephone: (86-755) 8307 1443, or email: CN.Doccheck@sgs.com

198 Kezhu Road, Sciencetech Park Guangzhou Economic & Technology Development District, Guangzhou, China 510663 t (86-20) 82155555 f (86-20) 82075113 www.sgs.com.cn  
 中国·广州·经济技术开发区科学城科珠路198号 邮编: 510663 t (86-20) 82155555 f (86-20) 82075113 e sgs.china@sgs.com

ATTACHMENTS

Elementary Testing Flow Chart

- 1) Name of the person who made testing: Bruce Xiao
- 2) Name of the person in charge of testing: Bella Wang

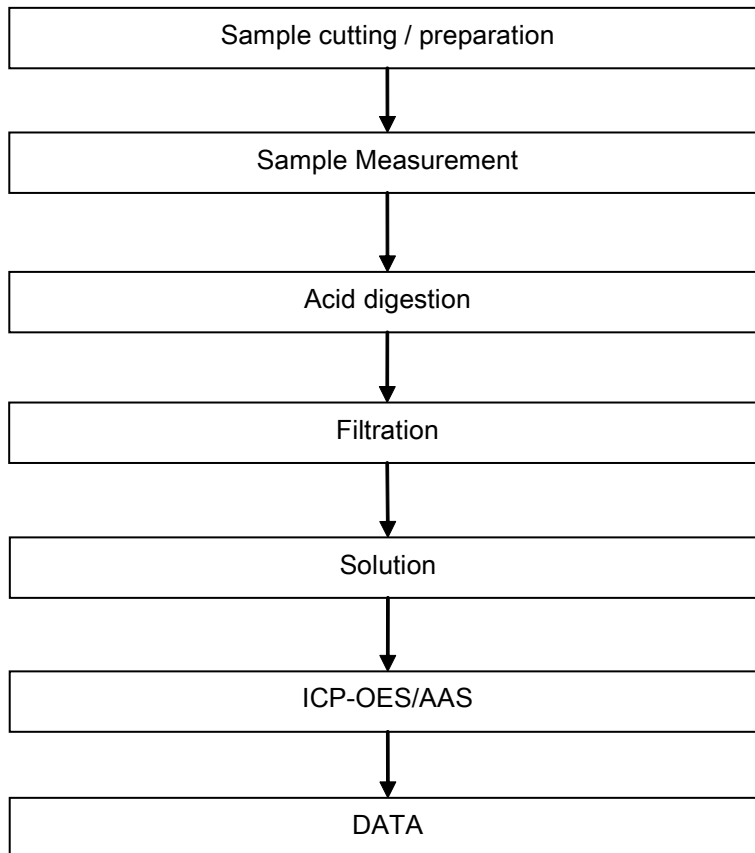

This document is issued by the Company subject to its General Conditions of Service printed overleaf, available on request or accessible at <http://www.sgs.com/en/Terms-and-Conditions.aspx> and, for electronic format documents, subject to Terms and Conditions for Electronic Documents at <http://www.sgs.com/en/Terms-and-Conditions/Terms-e-Documents.aspx>. Attention is drawn to the limitation of liability, indemnification and jurisdiction issues defined therein. Any holder of this document is advised that information contained hereon reflects the Company's findings at the time of its intervention only and within the limits of Client's instructions, if any. The Company's sole responsibility is to its Client and this document does not exonerate parties to a transaction from exercising all their rights and obligations under the transaction documents. This document cannot be reproduced except in full, without prior written approval of the Company. Any unauthorized alteration, forgery or falsification of the content or appearance of this document is unlawful and offenders may be prosecuted to the fullest extent of the law. Unless otherwise stated the results shown in this test report refer only to the sample(s) tested.

Attention: To check the authenticity of testing / inspection report & certificate, please contact us at telephone: (86-755) 8307 1443, or email: CN.Doccheck@sgs.com

198 Kezhu Road, Sciencetech Park Guangzhou Economic & Technology Development District, Guangzhou, China 510663 t (86-20) 82155555 f (86-20) 82075113 www.sgsgroup.com.cn  
 中国·广州·经济技术开发区科学城科珠路198号 邮编: 510663 t (86-20) 82155555 f (86-20) 82075113 e sgs.china@sgs.com

Sample photo:



SGS authenticate the photo on original report only

\*\*\* End of Report \*\*\*

## 測試報告

號碼(No.) : CE/2014/B1499

日期(Date) : 2014/11/17

頁數(Page): 1 of 6

## Test Report

德紘實業有限公司

AMPRO TECHNOLOGIES INC.

台北市羅斯福路一段78號4樓

4F, #78, ROOSEVELT ROAD, SECTION 1, TAIPEI, TAIWAN



以下測試樣品係由申請廠商所提供及確認 (The following sample(s) was/were submitted and identified by/on behalf of the applicant as) :

送樣廠商(Sample Submitted By) : 德紘實業有限公司 (AMPRO TECHNOLOGIES INC.)

樣品名稱(Sample Description) : HIGH DENSITY POLYETHYLENE RESINS

樣品型號(Style/Item No.) : LR590005

生產或供應廠商(Manufacturer/Vendor) : EQUISTAR CHEMICALS,LP.

原產國(Country of Origin) : U.S.A.

Lot No. : CL240329B1

收件日期(Sample Receiving Date) : 2014/11/11

測試期間(Testing Period) : 2014/11/11 TO 2014/11/17

=====  
測試需求(Test Requested) : 依據客戶要求, 參考RoHS 2011/65/EU Annex II 指令進行鎘, 鉛, 汞, 六價鉻, 多溴聯苯, 多溴聯苯醚測試. (As specified by client, with reference to RoHS Directive 2011/65/EU Annex II to determine Cadmium, Lead, Mercury, Cr(VI), PBBs, PBDEs contents in the submitted sample.)

測試方法(Test Method) : 請見下一頁 (Please refer to next pages).

測試結果(Test Results) : 請見下一頁 (Please refer to next pages).

結論(Conclusion) : 根據客戶所提供的樣品, 其鎘, 鉛, 汞, 六價鉻, 多溴聯苯, 多溴聯苯醚的測試結果符合 RoHS指令2002/95/EC的更新指令2011/65/EU之要求 (Based on the performed tests on submitted samples, the test result(s) of Cadmium, Lead, Mercury, Cr(VI), PBBs, PBDEs comply with the limits as set by RoHS Directive 2011/65/EU Annex II; recasting 2002/95/EC.)

Troy Chang, Manager - Tech  
Signed for and on behalf of  
SGS TAIWAN LTD.  
Chemical Laboratory - Taipei

## 測試報告

號碼(No.) : CE/2014/B1499

日期(Date) : 2014/11/17

頁數(Page): 2 of 6

## Test Report

德紘實業有限公司

AMPRO TECHNOLOGIES INC.

台北市羅斯福路一段78號4樓

4F, #78, ROOSEVELT ROAD, SECTION 1, TAIPEI, TAIWAN



### 測試結果(Test Results)

測試部位(PART NAME)No.1 : 白色塑膠粒 (WHITE PLASTIC PELLETS)

測試項目 (Test Items)	單位 (Unit)	測試方法 (Method)	方法偵測 極限值 (MDL)	結果 (Result)	法規 限值 (Limit)
				No.1	
鎘 / Cadmium (Cd)	mg/kg	參考 IEC 62321-5: 2013 方法, 以感應耦合電漿原子發射光譜儀檢測. / With reference to IEC 62321-5: 2013 and performed by ICP-AES.	2	n.d.	100
鉛 / Lead (Pb)	mg/kg	參考 IEC 62321-5: 2013 方法, 以感應耦合電漿原子發射光譜儀檢測. / With reference to IEC 62321-5: 2013 and performed by ICP-AES.	2	n.d.	1000
汞 / Mercury (Hg)	mg/kg	參考 IEC 62321-4: 2013 方法, 以感應耦合電漿原子發射光譜儀檢測. / With reference to IEC 62321-4: 2013 and performed by ICP-AES.	2	n.d.	1000
六價鉻 / Hexavalent Chromium Cr(VI)	mg/kg	參考 IEC 62321: 2008 方法, 以 UV-VIS 檢測. / With reference to IEC 62321: 2008 and performed by UV-VIS.	2	n.d.	1000
多溴聯苯總和 / Sum of PBBs	mg/kg	參考 IEC 62321: 2008 方法, 以氣相層析/質譜儀檢測. / With reference to IEC 62321: 2008 and performed by GC/MS.	-	n.d.	1000
一溴聯苯 / Monobromobiphenyl	mg/kg		5	n.d.	-
二溴聯苯 / Dibromobiphenyl	mg/kg		5	n.d.	-
三溴聯苯 / Tribromobiphenyl	mg/kg		5	n.d.	-
四溴聯苯 / Tetrabromobiphenyl	mg/kg		5	n.d.	-
五溴聯苯 / Pentabromobiphenyl	mg/kg		5	n.d.	-
六溴聯苯 / Hexabromobiphenyl	mg/kg		5	n.d.	-
七溴聯苯 / Heptabromobiphenyl	mg/kg		5	n.d.	-
八溴聯苯 / Octabromobiphenyl	mg/kg		5	n.d.	-
九溴聯苯 / Nonabromobiphenyl	mg/kg		5	n.d.	-
十溴聯苯 / Decabromobiphenyl	mg/kg	5	n.d.	-	

This document is issued by the Company subject to its General Conditions of Service printed overleaf, available on request or accessible at <http://www.sgs.com/en/Terms-and-Conditions.aspx> and, for electronic format documents, subject to Terms and Conditions for Electronic Documents at <http://www.sgs.com/en/Terms-and-Conditions/Term-Document.aspx>. Attention is drawn to the limitation of liability, indemnification and jurisdiction issues defined therein. Any holder of this document is advised that information contained hereon reflects the Company's findings at the time of its intervention only and within the limits of client's instruction, if any. The Company's sole responsibility is to its Client and this document does not exonerate parties to a transaction from exercising all their rights and obligations under the transaction documents. This document cannot be reproduced, except in full, without prior written approval of the Company. Any unauthorized alteration, forgery or falsification of the content or appearance of this document is unlawful and offenders may be prosecuted to the fullest extent of the law. Unless otherwise stated the results shown in this test report refer only to the sample(s) tested.

# 測試報告

號碼(No.) : CE/2014/B1499

日期(Date) : 2014/11/17

頁數(Page): 3 of 6

# Test Report

德紘實業有限公司

AMPRO TECHNOLOGIES INC.

台北市羅斯福路一段78號4樓

4F, #78, ROOSEVELT ROAD, SECTION 1, TAIPEI, TAIWAN



測試項目 (Test Items)	單位 (Unit)	測試方法 (Method)	方法偵測 極限值 (MDL)	結果 (Result) No.1	法規 限值 (Limit)
多溴聯苯醚總和 / Sum of PBDEs	mg/kg	參考IEC 62321: 2008方法, 以氣相層析/質譜儀檢測. / With reference to IEC 62321: 2008 and performed by GC/MS.	-	n.d.	1000
一溴聯苯醚 / Monobromodiphenyl ether	mg/kg		5	n.d.	-
二溴聯苯醚 / Dibromodiphenyl ether	mg/kg		5	n.d.	-
三溴聯苯醚 / Tribromodiphenyl ether	mg/kg		5	n.d.	-
四溴聯苯醚 / Tetrabromodiphenyl ether	mg/kg		5	n.d.	-
五溴聯苯醚 / Pentabromodiphenyl ether	mg/kg		5	n.d.	-
六溴聯苯醚 / Hexabromodiphenyl ether	mg/kg		5	n.d.	-
七溴聯苯醚 / Heptabromodiphenyl ether	mg/kg		5	n.d.	-
八溴聯苯醚 / Octabromodiphenyl ether	mg/kg		5	n.d.	-
九溴聯苯醚 / Nonabromodiphenyl ether	mg/kg		5	n.d.	-
十溴聯苯醚 / Decabromodiphenyl ether	mg/kg	5	n.d.	-	

### 備註(Note) :

1. mg/kg = ppm ; 0.1wt% = 1000ppm
2. n.d. = Not Detected (未檢出)
3. MDL = Method Detection Limit (方法偵測極限值)
4. "-" = Not Regulated (無規格值)



## 測試報告

號碼(No.) : CE/2014/B1499

日期(Date) : 2014/11/17

頁數(Page): 4 of 6

## Test Report

德紘實業有限公司

AMPRO TECHNOLOGIES INC.

台北市羅斯福路一段78號4樓

4F, #78, ROOSEVELT ROAD, SECTION 1, TAIPEI, TAIWAN



- 1) 根據以下的流程圖之條件，樣品已完全溶解。(六價鉻測試方法除外) / These samples were dissolved totally by pre-conditioning method according to below flow chart. (Cr<sup>6+</sup> test method excluded)
- 2) 測試人員：楊登偉 / Name of the person who made measurement: Climbgreat Yang
- 3) 測試負責人：張啓興 / Name of the person in charge of measurement: Troy Chang

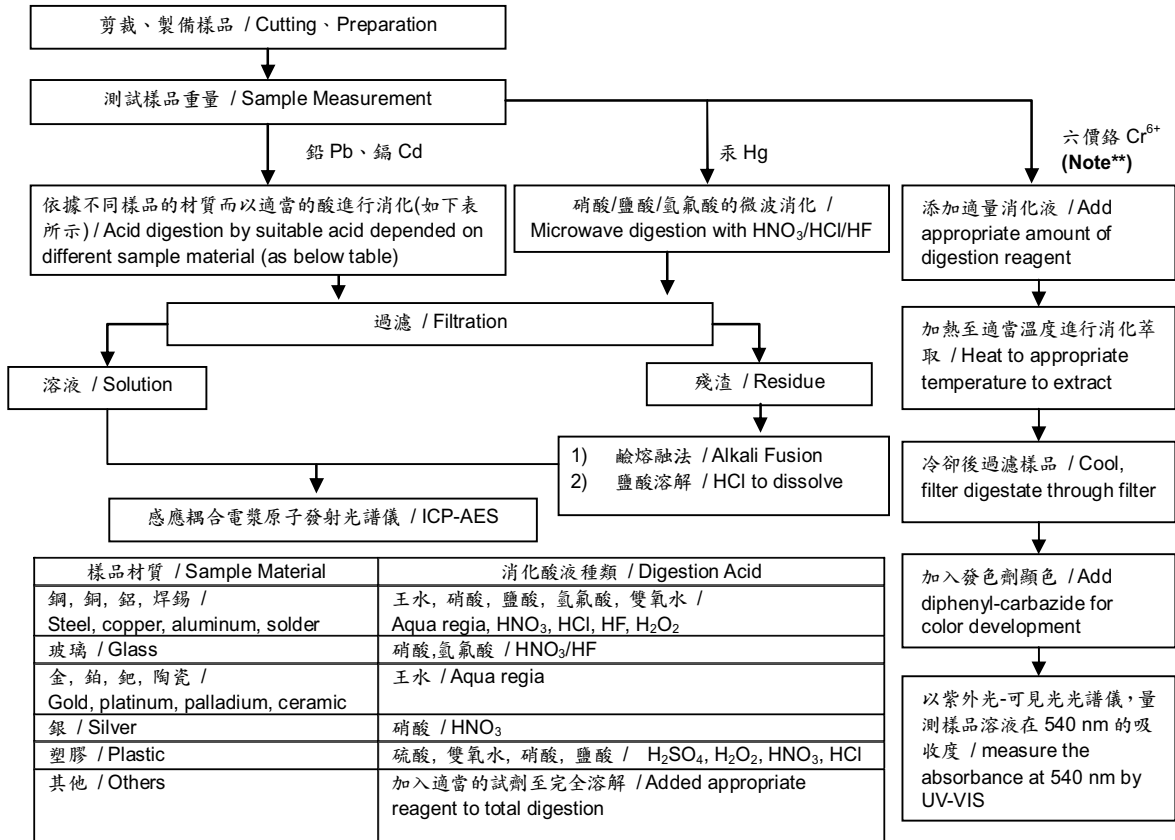

- Note\*\*:** (1) 針對非金屬材料加入鹼性消化液, 加熱至 90~95°C 萃取. / For non-metallic material, add alkaline digestion reagent and heat to 90~95°C.  
 (2) 針對金屬材料加入純水, 加熱至沸騰萃取. / For metallic material, add pure water and heat to boiling.

## 測試報告

號碼(No.) : CE/2014/B1499

日期(Date) : 2014/11/17

頁數(Page): 5 of 6

## Test Report

德紘實業有限公司

AMPRO TECHNOLOGIES INC.

台北市羅斯福路一段78號4樓

4F, #78, ROOSEVELT ROAD, SECTION 1, TAIPEI, TAIWAN



### 多溴聯苯/多溴聯苯醚分析流程圖 / PBB/PBDE analytical FLOW CHART

- 測試人員：翁賜彬 / Name of the person who made measurement: Roman Wong
  - 測試負責人：張啓興 / Name of the person in charge of measurement: Troy Chang
- 初次測試程序 / First testing process —————>
- 選擇性篩檢程序 / Optional screen process .....>
- 確認程序 / Confirmation process - - ->

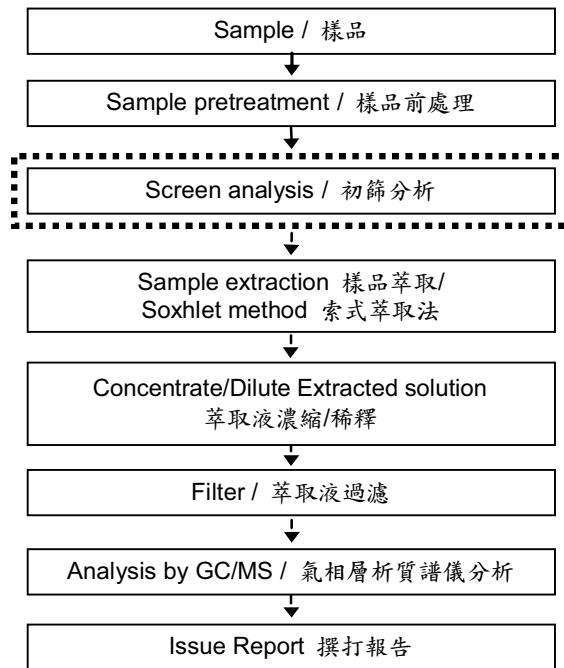



## 測試報告

號碼(No.) : CE/2014/B1499

日期(Date) : 2014/11/17

頁數(Page): 6 of 6

## Test Report

德紘實業有限公司

AMPRO TECHNOLOGIES INC.

台北市羅斯福路一段78號4樓

4F, #78, ROOSEVELT ROAD, SECTION 1, TAIPEI, TAIWAN



\* 照片中如有箭頭標示，則表示為實際檢測之樣品/部位。 \*

(The tested sample / part is marked by an arrow if it's shown on the photo.)

### CE/2014/B1499

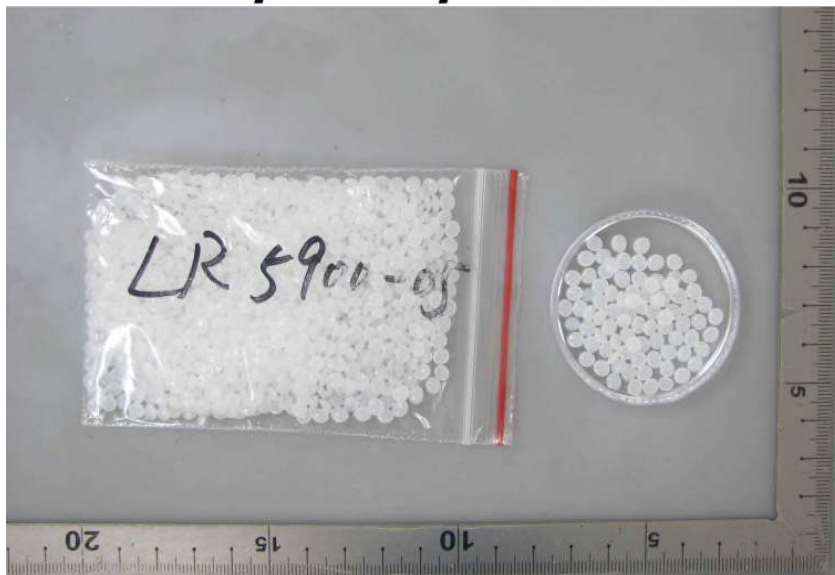

\*\* 報告結尾 (End of Report) \*\*

# Test Report

No. CANEC1406722801

Date: 13 May 2014

Page 1 of 10

SUNVIC TECHNOLOGY CO.LTD

XITOU ADMINISTRATION DISTRICT HOUJIE TOWN,DONGGUAN CITY,GUANGDONG PROVINCE

The following sample(s) was/were submitted and identified on behalf of the clients as : Blue AI/Pet

SGS Job No. : CP14-022625 - SZ

Lot No. : 25140415083

Date of Sample Received : 07 May 2014

Testing Period : 07 May 2014 - 13 May 2014

Test Requested : Selected test(s) as requested by client.

Test Method : Please refer to next page(s).

Test Results : Please refer to next page(s).

Conclusion : Based on the performed tests on submitted samples, the results of Lead, Mercury, Cadmium, Hexavalent chromium, Polybrominated biphenyls (PBB), Polybrominated diphenyl ethers (PBDE) comply with the limits as set by RoHS Directive 2011/65/EU Annex II; recasting 2002/95/EC.

Signed for and on behalf of  
SGS-CSTC Ltd.

Daisy Dai  
Approved Signatory



This document is issued by the Company subject to its General Conditions of Service printed overleaf, available on request or accessible at <http://www.sgs.com/en/Terms-and-Conditions.aspx> and, for electronic format documents, subject to Terms and Conditions for Electronic Documents at <http://www.sgs.com/en/Terms-and-Conditions/Terms-e-Document.aspx>. Attention is drawn to the limitation of liability, indemnification and jurisdiction issues defined therein. Any holder of this document is advised that information contained hereon reflects the Company's findings at the time of its intervention only and within the limits of Client's instructions, if any. The Company's sole responsibility is to its Client and this document does not exonerate parties to a transaction from exercising all their rights and obligations under the transaction documents. This document cannot be reproduced except in full, without prior written approval of the Company. Any unauthorized alteration, forgery or falsification of the content or appearance of this document is unlawful and offenders may be prosecuted to the fullest extent of the law. Unless otherwise stated the results shown in this test report refer only to the sample(s) tested.  
**Attention: To check the authenticity of testing /inspection report & certificate, please contact us at telephone: (86-755) 8307 1443, or email: CN.Doccheck@sgs.com**

SGS-CSTC Standards Technical Services Co., Ltd.  
Guangzhou Chemical Laboratory

198 Kezhu Road, Sciencetech Park Guangzhou Economic & Technology Development District, Guangzhou, China 510663 t (86-20) 82155555 f (86-20) 82075113 www.sgsgroup.com.cn  
中国·广州·经济技术开发区科学城科珠路198号 邮编: 510663 t (86-20) 82155555 f (86-20) 82075113 e sgs.china@sgs.com

# Test Report

No. CANEC1406722801

Date: 13 May 2014

Page 2 of 10

Test Results :

Test Part Description :

Specimen No.	SGS Sample ID	Description
SN1	CAN14-067228.001	Blue/silvery sheet

Remarks :

- (1) 1 mg/kg = 1 ppm = 0.0001%
- (2) MDL = Method Detection Limit
- (3) ND = Not Detected ( < MDL )
- (4) "-" = Not Regulated

**RoHS Directive 2011/65/EU**

- Test Method :
- (1)With reference to IEC 62321-5:2013, determination of Cadmium by ICP-OES.
  - (2)With reference to IEC 62321-5:2013, determination of Lead by ICP-OES.
  - (3)With reference to IEC 62321-4:2013, determination of Mercury by ICP-OES.
  - (4)With reference to IEC 62321:2008, determination of Hexavalent Chromium by Colorimetric Method using UV-Vis.
  - (5)With reference to IEC 62321:2008, determination of PBBs and PBDEs by GC-MS.

<u>Test Item(s)</u>	<u>Limit</u>	<u>Unit</u>	<u>MDL</u>	<u>001</u>
Cadmium (Cd)	100	mg/kg	2	ND
Lead (Pb)	1,000	mg/kg	2	ND
Mercury (Hg)	1,000	mg/kg	2	ND
Hexavalent Chromium (CrVI)	1,000	mg/kg	2	ND
Sum of PBBs	1,000	mg/kg	-	ND
Monobromobiphenyl	-	mg/kg	5	ND
Dibromobiphenyl	-	mg/kg	5	ND
Tribromobiphenyl	-	mg/kg	5	ND
Tetrabromobiphenyl	-	mg/kg	5	ND
Pentabromobiphenyl	-	mg/kg	5	ND
Hexabromobiphenyl	-	mg/kg	5	ND
Heptabromobiphenyl	-	mg/kg	5	ND
Octabromobiphenyl	-	mg/kg	5	ND
Nonabromobiphenyl	-	mg/kg	5	ND
Decabromobiphenyl	-	mg/kg	5	ND
Sum of PBDEs	1,000	mg/kg	-	ND
Monobromodiphenyl ether	-	mg/kg	5	ND



This document is issued by the Company subject to its General Conditions of Service printed overleaf, available on request or accessible at <http://www.sgs.com/en/Terms-and-Conditions.aspx> and, for electronic format documents, subject to Terms and Conditions for Electronic Documents at <http://www.sgs.com/en/Terms-and-Conditions/Terms-e-Documents.aspx>. Attention is drawn to the limitation of liability, indemnification and jurisdiction issues defined therein. Any holder of this document is advised that information contained hereon reflects the Company's findings at the time of its intervention only and within the limits of Client's instructions, if any. The Company's sole responsibility is to its Client and this document does not exonerate parties to a transaction from exercising all their rights and obligations under the transaction documents. This document cannot be reproduced except in full, without prior written approval of the Company. Any unauthorized alteration, forgery or falsification of the content or appearance of this document is unlawful and offenders may be prosecuted to the fullest extent of the law. Unless otherwise stated the results shown in this test report refer only to the sample(s) tested.

Attention: To check the authenticity of testing /inspection report & certificate, please contact us at telephone: (86-755) 8307 1443, or email: [CN.Doccheck@sgs.com](mailto:CN.Doccheck@sgs.com)

198 Kezhu Road, Sciencetech Park Guangzhou Economic & Technology Development District, Guangzhou, China 510663 t (86-20) 82155555 f (86-20) 82075113 www.sgs.com.cn  
中国·广州·经济技术开发区科学城科珠路198号 邮编: 510663 t (86-20) 82155555 f (86-20) 82075113 e [sgs.china@sgs.com](mailto:sgs.china@sgs.com)

## Test Report

No. CANEC1406722801

Date: 13 May 2014

Page 3 of 10

<u>Test Item(s)</u>	<u>Limit</u>	<u>Unit</u>	<u>MDL</u>	<u>001</u>
Dibromodiphenyl ether	-	mg/kg	5	ND
Tribromodiphenyl ether	-	mg/kg	5	ND
Tetrabromodiphenyl ether	-	mg/kg	5	ND
Pentabromodiphenyl ether	-	mg/kg	5	ND
Hexabromodiphenyl ether	-	mg/kg	5	ND
Heptabromodiphenyl ether	-	mg/kg	5	ND
Octabromodiphenyl ether	-	mg/kg	5	ND
Nonabromodiphenyl ether	-	mg/kg	5	ND
Decabromodiphenyl ether	-	mg/kg	5	ND

### Notes :

- (1) The maximum permissible limit is quoted from the directive 2011/65/EU, Annex II.

### Halogen

Test Method : With reference to EN 14582: 2007, analysis was performed by Ion Chromatograph (IC).

<u>Test Item(s)</u>	<u>Unit</u>	<u>MDL</u>	<u>001</u>
Fluorine (F)	mg/kg	50	ND
Chlorine (Cl)	mg/kg	50	ND
Bromine (Br)	mg/kg	50	ND
Iodine (I)	mg/kg	50	ND

### Hexabromocyclododecane (HBCDD)

Test Method : Determination of HBCDD by GC-MS based on IEC 62321:2008.

<u>Test Item(s)</u>	<u>Unit</u>	<u>MDL</u>	<u>001</u>
Hexabromocyclododecane (HBCDD)	mg/kg	10	ND

### Notes :

- (1) Reference Information: Directive 2011/65/EU recasting RoHS directive 2002/95/EC: Hexabromocyclododecane (HBCDD) is considered as a priority for risk evaluation and substance restriction.

### PFOS (Perfluorooctane Sulfonates)

Test Method : With reference to US EPA 3550C: 2007, analysis was performed by HPLC-MS.



This document is issued by the Company subject to its General Conditions of Service printed overleaf, available on request or accessible at <http://www.sgs.com/en/Terms-and-Conditions.aspx> and, for electronic format documents, subject to Terms and Conditions for Electronic Documents at <http://www.sgs.com/en/Terms-and-Conditions/Terms-e-Documents.aspx>. Attention is drawn to the limitation of liability, indemnification and jurisdiction issues defined therein. Any holder of this document is advised that information contained hereon reflects the Company's findings at the time of its intervention only and within the limits of Client's instructions, if any. The Company's sole responsibility is to its Client and this document does not exonerate parties to a transaction from exercising all their rights and obligations under the transaction documents. This document cannot be reproduced except in full, without prior written approval of the Company. Any unauthorized alteration, forgery or falsification of the content or appearance of this document is unlawful and offenders may be prosecuted to the fullest extent of the law. Unless otherwise stated the results shown in this test report refer only to the sample(s) tested.

Attention: To check the authenticity of testing / inspection report & certificate, please contact us at telephone: (86-755) 8307 1443, or email: CN.Doccheck@sgs.com

## Test Report

No. CANEC1406722801

Date: 13 May 2014

Page 4 of 10

<u>Test Item(s)</u>	<u>Unit</u>	<u>MDL</u>	<u>001</u>
Perfluorooctane Sulfonates (PFOS) and related Acid, Metal Salt and Amide	mg/kg	10	ND

### Notes :

For reference: commission regulation (EU) No 757/2010 amending regulation (EC) No 850/2004:  
 (1) For the purposes of this entry, Article 4(1) (b) shall apply to concentrations of PFOS equal to or below 10 mg/kg (0,001 % by weight) when it occurs in substances or in preparations.  
 (2) For the purposes of this entry, Article 4(1) (b) shall apply to concentrations of PFOS in semi-finished products or articles, or parts thereof, if the concentration of PFOS is lower than 0,1 % by weight calculated with reference to the mass of structurally or micro-structurally distinct parts that contain PFOS or, for textiles or other coated materials, if the amount of PFOS is lower than 1µg /m<sup>2</sup> of the coated material.

### Phthalate

Test Method : Determination of phthalates by GC-MS based on EN 14372:2004.

<u>Test Item(s)</u>	<u>CAS NO.</u>	<u>Unit</u>	<u>MDL</u>	<u>001</u>
Dibutyl Phthalate (DBP)	84-74-2	%(w/w)	0.003	ND
Benzylbutyl Phthalate (BBP)	85-68-7	%(w/w)	0.003	ND
Bis-(2-ethylhexyl) Phthalate (DEHP)	117-81-7	%(w/w)	0.003	ND
Diisobutyl Phthalate (DIBP)	84-69-5	%(w/w)	0.003	ND

### Notes :

(1) Reference Information: Directive 2011/65/EU recasting RoHS directive 2002/95/EC:  
 Bis (2-ethylhexyl) phthalate (DEHP), Butyl benzyl phthalate (BBP) and Dibutyl phthalate (DBP) are considered as a priority for risk evaluation and substance restriction.



This document is issued by the Company subject to its General Conditions of Service printed overleaf, available on request or accessible at <http://www.sgs.com/en/Terms-and-Conditions.aspx> and, for electronic format documents, subject to Terms and Conditions for Electronic Documents at <http://www.sgs.com/en/Terms-and-Conditions/Terms-e-Documents.aspx>. Attention is drawn to the limitation of liability, indemnification and jurisdiction issues defined therein. Any holder of this document is advised that information contained hereon reflects the Company's findings at the time of its intervention only and within the limits of Client's instructions, if any. The Company's sole responsibility is to its Client and this document does not exonerate parties to a transaction from exercising all their rights and obligations under the transaction documents. This document cannot be reproduced except in full, without prior written approval of the Company. Any unauthorized alteration, forgery or falsification of the content or appearance of this document is unlawful and offenders may be prosecuted to the fullest extent of the law. Unless otherwise stated the results shown in this test report refer only to the sample(s) tested.  
 Attention: To check the authenticity of testing /inspection report & certificate, please contact us at telephone: (86-755) 8307 1443, or email: CN.Doccheck@sgs.com



ATTACHMENTS

RoHS Testing Flow Chart

- 1) Name of the person who made testing: Michael Tso / Cutey Yu
- 2) Name of the person in charge of testing: Adams Yu / Yolanda Wei
- 3) These samples were dissolved totally by pre-conditioning method according to below flow chart (Cr<sup>6+</sup> and PBBs/PBDEs test method excluded).

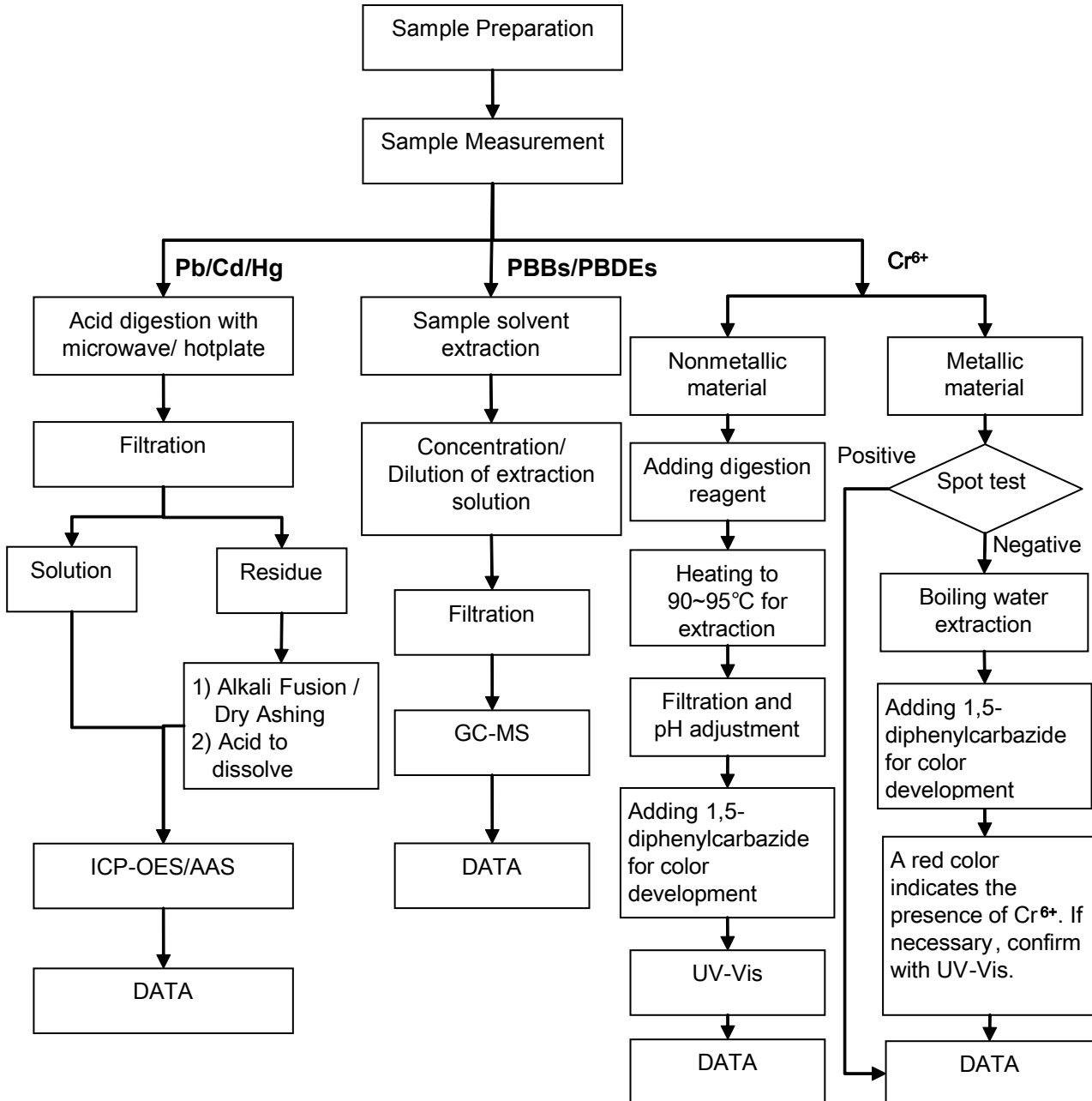

This document is issued by the Company subject to its General Conditions of Service printed overleaf, available on request or accessible at <http://www.sgs.com/en/Terms-and-Conditions.aspx> and, for electronic format documents, subject to Terms and Conditions for Electronic Documents at <http://www.sgs.com/en/Terms-and-Conditions/Terms-e-Documents.aspx>. Attention is drawn to the limitation of liability, indemnification and jurisdiction issues defined therein. Any holder of this document is advised that information contained hereon reflects the Company's findings at the time of its intervention only and within the limits of Client's instructions, if any. The Company's sole responsibility is to its Client and this document does not exonerate parties to a transaction from exercising all their rights and obligations under the transaction documents. This document cannot be reproduced except in full, without prior written approval of the Company. Any unauthorized alteration, forgery or falsification of the content or appearance of this document is unlawful and offenders may be prosecuted to the fullest extent of the law. Unless otherwise stated the results shown in this test report refer only to the sample(s) tested.

Attention: To check the authenticity of testing / inspection report & certificate, please contact us at telephone: (86-755) 8307 1443, or email: CN.Doccheck@sgs.com

198 Kezhu Road, Sciotech Park Guangzhou Economic & Technology Development District, Guangzhou, China 510663 t (86-20) 82155555 f (86-20) 82075113 www.sgsgroup.com.cn  
 中国·广州·经济技术开发区科学城科珠路198号 邮编: 510663 t (86-20) 82155555 f (86-20) 82075113 e sgs.china@sgs.com

ATTACHMENTS

HBCDD Testing Flow Chart

- 1) Name of the person who made testing: Cutey Yu
- 2) Name of the person in charge of testing: Yolanda Wei

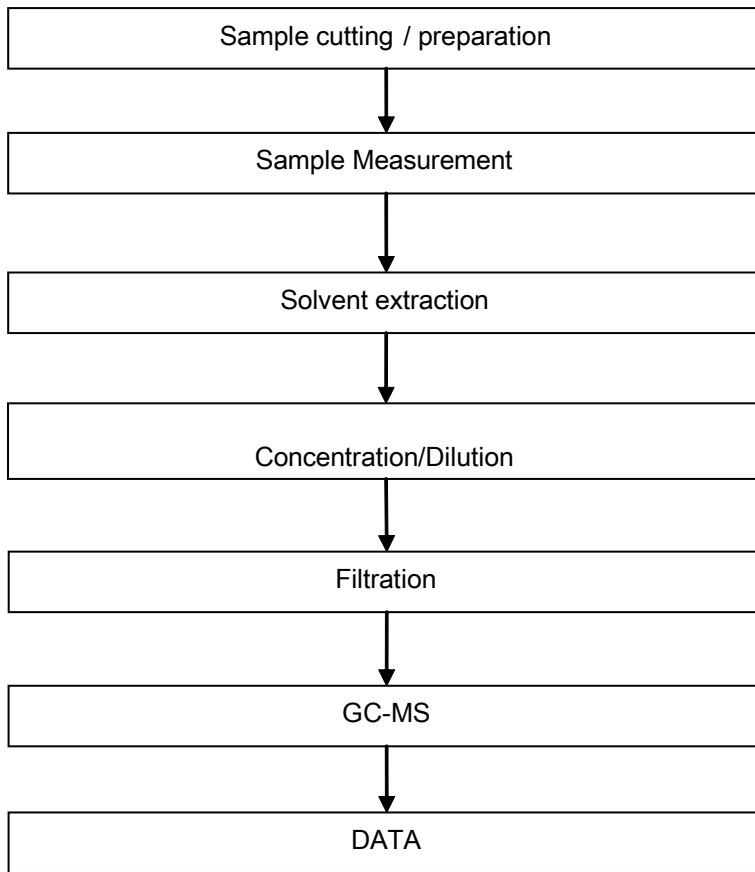

This document is issued by the Company subject to its General Conditions of Service printed overleaf, available on request or accessible at <http://www.sgs.com/en/Terms-and-Conditions.aspx> and, for electronic format documents, subject to Terms and Conditions for Electronic Documents at <http://www.sgs.com/en/Terms-and-Conditions/Terms-e-Documents.aspx>. Attention is drawn to the limitation of liability, indemnification and jurisdiction issues defined therein. Any holder of this document is advised that information contained hereon reflects the Company's findings at the time of its intervention only and within the limits of Client's instructions, if any. The Company's sole responsibility is to its Client and this document does not exonerate parties to a transaction from exercising all their rights and obligations under the transaction documents. This document cannot be reproduced except in full, without prior written approval of the Company. Any unauthorized alteration, forgery or falsification of the content or appearance of this document is unlawful and offenders may be prosecuted to the fullest extent of the law. Unless otherwise stated the results shown in this test report refer only to the sample(s) tested.

Attention: To check the authenticity of testing / inspection report & certificate, please contact us at telephone: (86-755) 8307 1443, or email: CN.Doccheck@sgs.com

198 Kezhu Road, Sciencetech Park Guangzhou Economic & Technology Development District, Guangzhou, China 510663 t (86-20) 82155555 f (86-20) 82075113 www.sgsgroup.com.cn  
 中国·广州·经济技术开发区科学城科珠路198号 邮编: 510663 t (86-20) 82155555 f (86-20) 82075113 e sgs.china@sgs.com

ATTACHMENTS

Phthalates Testing Flow Chart

- 1) Name of the person who made testing: Liu Qiong
- 2) Name of the person in charge of testing: Yolanda Wei

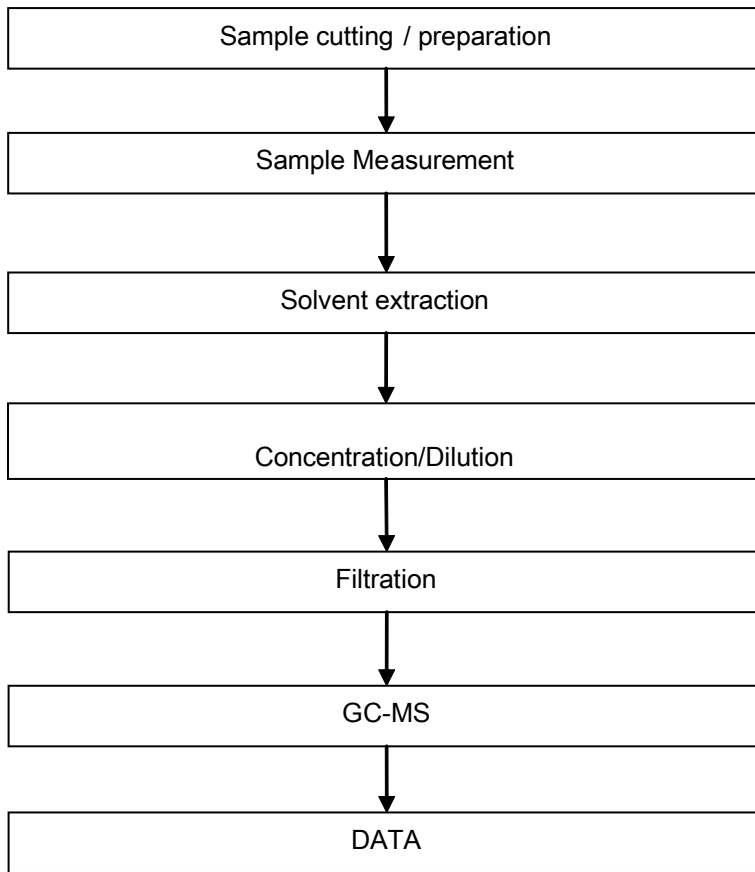

This document is issued by the Company subject to its General Conditions of Service printed overleaf, available on request or accessible at <http://www.sgs.com/en/Terms-and-Conditions.aspx> and, for electronic format documents, subject to Terms and Conditions for Electronic Documents at <http://www.sgs.com/en/Terms-and-Conditions/Terms-e-Documents.aspx>. Attention is drawn to the limitation of liability, indemnification and jurisdiction issues defined therein. Any holder of this document is advised that information contained hereon reflects the Company's findings at the time of its intervention only and within the limits of Client's instructions, if any. The Company's sole responsibility is to its Client and this document does not exonerate parties to a transaction from exercising all their rights and obligations under the transaction documents. This document cannot be reproduced except in full, without prior written approval of the Company. Any unauthorized alteration, forgery or falsification of the content or appearance of this document is unlawful and offenders may be prosecuted to the fullest extent of the law. Unless otherwise stated the results shown in this test report refer only to the sample(s) tested.

Attention: To check the authenticity of testing /inspection report & certificate, please contact us at telephone: (86-755) 8307 1443, or email: [CN.Doccheck@sgs.com](mailto:CN.Doccheck@sgs.com)

198 Kezhu Road, Sciencetech Park Guangzhou Economic & Technology Development District, Guangzhou, China 510663 t (86-20) 82155555 f (86-20) 82075113 www.sgsgroup.com.cn  
中国·广州·经济技术开发区科学城科珠路198号 邮编: 510663 t (86-20) 82155555 f (86-20) 82075113 e [sgs.china@sgs.com](mailto:sgs.china@sgs.com)



ATTACHMENTS

PFOA / PFOS Testing Flow Chart

- 1) Name of the person who made testing: Tina Zhao
- 2) Name of the person in charge of testing: Yolanda Wei

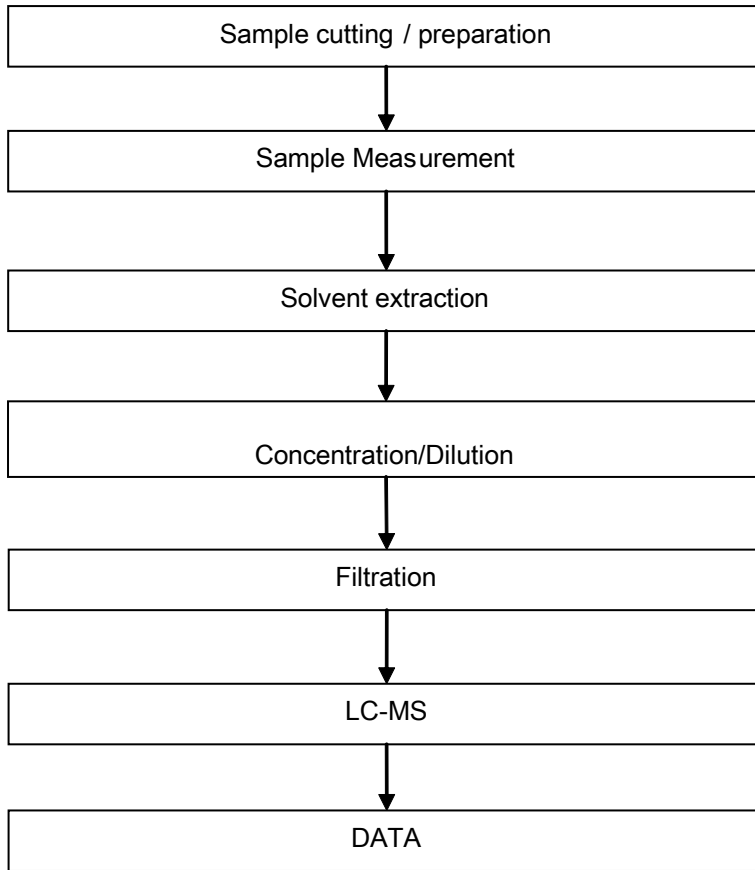

This document is issued by the Company subject to its General Conditions of Service printed overleaf, available on request or accessible at <http://www.sgs.com/en/Terms-and-Conditions.aspx> and, for electronic format documents, subject to Terms and Conditions for Electronic Documents at <http://www.sgs.com/en/Terms-and-Conditions/Terms-e-Documents.aspx>. Attention is drawn to the limitation of liability, indemnification and jurisdiction issues defined therein. Any holder of this document is advised that information contained hereon reflects the Company's findings at the time of its intervention only and within the limits of Client's instructions, if any. The Company's sole responsibility is to its Client and this document does not exonerate parties to a transaction from exercising all their rights and obligations under the transaction documents. This document cannot be reproduced except in full, without prior written approval of the Company. Any unauthorized alteration, forgery or falsification of the content or appearance of this document is unlawful and offenders may be prosecuted to the fullest extent of the law. Unless otherwise stated the results shown in this test report refer only to the sample(s) tested.

Attention: To check the authenticity of testing / inspection report & certificate, please contact us at telephone: (86-755) 8307 1443, or email: CN.Doccheck@sgs.com

198 Kezhu Road, Sciencetech Park Guangzhou Economic & Technology Development District, Guangzhou, China 510663 t (86-20) 82155555 f (86-20) 82075113 www.sgsgroup.com.cn  
 中国·广州·经济技术开发区科学城科珠路198号 邮编: 510663 t (86-20) 82155555 f (86-20) 82075113 e sgs.china@sgs.com

ATTACHMENTS

Halogen Testing Flow Chart

- 1) Name of the person who made testing: Bella Wang
- 2) Name of the person in charge of testing: Adams Yu

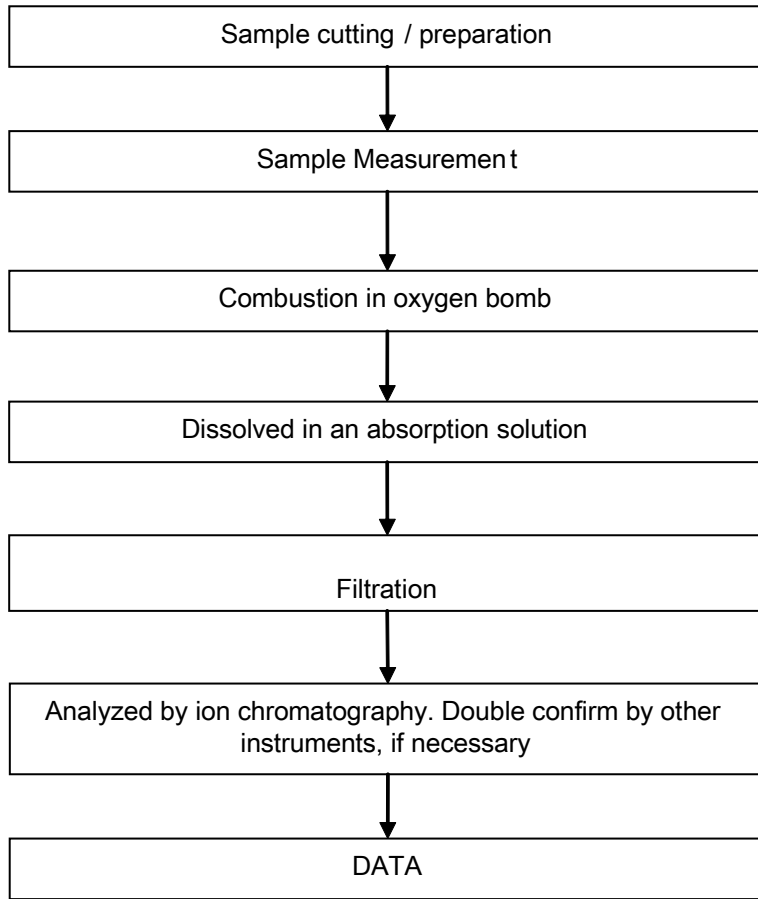

This document is issued by the Company subject to its General Conditions of Service printed overleaf, available on request or accessible at <http://www.sgs.com/en/Terms-and-Conditions.aspx> and, for electronic format documents, subject to Terms and Conditions for Electronic Documents at <http://www.sgs.com/en/Terms-and-Conditions/Terms-e-Documents.aspx>. Attention is drawn to the limitation of liability, indemnification and jurisdiction issues defined therein. Any holder of this document is advised that information contained hereon reflects the Company's findings at the time of its intervention only and within the limits of Client's instructions, if any. The Company's sole responsibility is to its Client and this document does not exonerate parties to a transaction from exercising all their rights and obligations under the transaction documents. This document cannot be reproduced except in full, without prior written approval of the Company. Any unauthorized alteration, forgery or falsification of the content or appearance of this document is unlawful and offenders may be prosecuted to the fullest extent of the law. Unless otherwise stated the results shown in this test report refer only to the sample(s) tested.

Attention: To check the authenticity of testing / inspection report & certificate, please contact us at telephone: (86-755) 8307 1443, or email: [CN.Doccheck@sgs.com](mailto:CN.Doccheck@sgs.com)

Sample photo:

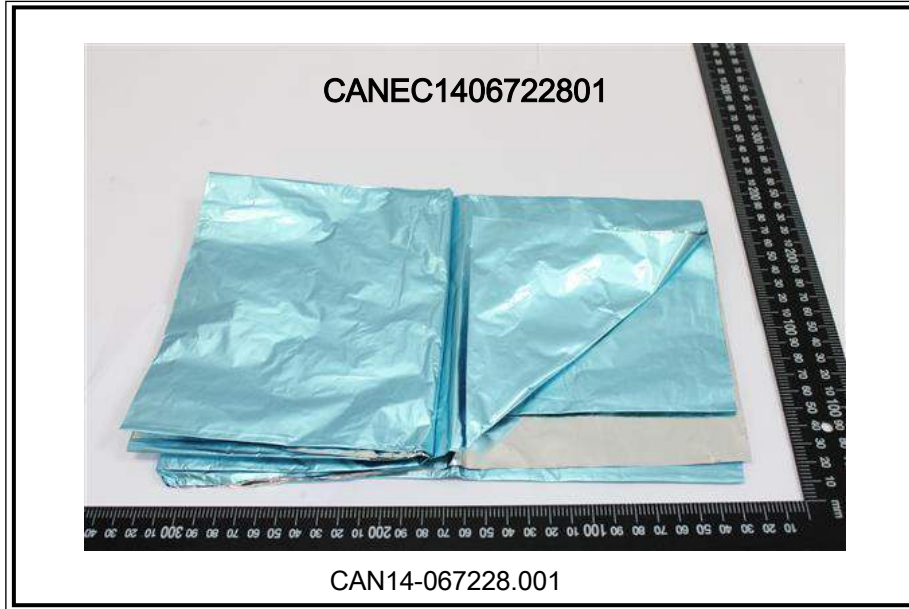

SGS authenticate the photo on original report only

\*\*\* End of Report \*\*\*

**Cross Section**



**Marking**

NONE

**Description**

Rated Voltage (V)	30
Rated Temperature (°C)	105

**Construction**

<b>4Cores</b>	<b>Stranded Tinned Copper</b>
AWG	30
Construction	7/0.10
Stranded Dia. (mm)	0.3
<b>Insulation</b>	<b>PVC</b>
Nom. Thickness (mm)	0.18
Min. Thickness (mm)	0.13
Insulation Dia. (±0.05mmx±0.15mm)	0.70x3.10
<b>Weight (kg/km)</b>	-----

**Color**

color of insulation:

According to the customers' requirement

Part No. : ZHAA9-0013

Customer's name: 珠海展興機械

Length/Reel: 610m/R  
 Ref. spec No. : GD-9245

Rev: 0

**Revision History**

---

**Performance**

**Electrical Characteristics:**

Dielectric Strength (kV/min)	0.5
Max. DC Resistance at 20°C (Ω/km)	381



**LTK WIRING CO. LTD.**  
 7/F Harbour View 2, 16 Science Park East Avenue  
 Hong Kong Science Park, Shatin, Hong Kong  
 Tel: (852) 2382 1133 Fax: (852) 2480 6327  
 Email: sales@ltkable.com URL: http://www.ltkable.com

A BELDEN COMPANY

- LTK Electric Wire (Huizhou) Ltd.
- Dalian LTK Electric Wire Ltd.
- LTK Industries (Suzhou) Ltd.
- LTK Cable (Chongqing) Ltd.

Prepared by: HONGNLI 2009.10.07 Table No.:TFA046 Rev.: 4  
 Approved by: YANGXH 2009.10.07 Page 1 of 1



## AVLV2.E148000 Appliance Wiring Material - Component

[Page Bottom](#)

### Appliance Wiring Material - Component

[See General Information for Appliance Wiring Material - Component](#)

#### LTK ELECTRIC WIRE (HUIZHOU) LTD

E148000

DESAY 3RD INDUSTRIAL DISTRICT  
CHEN JIANG TOWN, ZHONG KAI RD  
HUIZHOU, GUANGDONG 516229 CHINA

Table of Recognized Styles							
Single-conductor, thermoplastic insulation.							
<a href="#">1006</a>	<a href="#">1497</a>	<a href="#">1672</a>	<a href="#">1839</a>	<a href="#">10064</a>	<a href="#">10309</a>	<a href="#">10795</a>	<a href="#">10953</a>
<a href="#">1007</a>	<a href="#">1499</a>	<a href="#">1674</a>	<a href="#">1848</a>	<a href="#">10067</a>	<a href="#">10310</a>	<a href="#">10796</a>	<a href="#">10958</a>
<a href="#">1015</a>	<a href="#">1500</a>	<a href="#">1680</a>	<a href="#">1849</a>	<a href="#">10072</a>	<a href="#">10311</a>	<a href="#">10797</a>	<a href="#">10981</a>
<a href="#">1019</a>	<a href="#">1503</a>	<a href="#">1681</a>	<a href="#">1862</a>	<a href="#">10076</a>	<a href="#">10312</a>	<a href="#">10798</a>	<a href="#">10982</a>
<a href="#">1028</a>	<a href="#">1504</a>	<a href="#">1683</a>	<a href="#">1863</a>	<a href="#">10086</a>	<a href="#">10313</a>	<a href="#">10799</a>	<a href="#">10983</a>
<a href="#">1032</a>	<a href="#">1505</a>	<a href="#">1685</a>	<a href="#">1864</a>	<a href="#">10090</a>	<a href="#">10314</a>	<a href="#">10800</a>	<a href="#">10984</a>
<a href="#">1056</a>	<a href="#">1508</a>	<a href="#">1691</a>	<a href="#">1865</a>	<a href="#">10097</a>	<a href="#">10316</a>	<a href="#">10801</a>	<a href="#">10985</a>
<a href="#">1061</a>	<a href="#">1516</a>	<a href="#">1692</a>	<a href="#">1866</a>	<a href="#">10098</a>	<a href="#">10325</a>	<a href="#">10802</a>	<a href="#">10986</a>
<a href="#">1067</a>	<a href="#">1517</a>	<a href="#">1696</a>	<a href="#">1870</a>	<a href="#">10099</a>	<a href="#">10328</a>	<a href="#">10803</a>	<a href="#">10987</a>
<a href="#">1071</a>	<a href="#">1523</a>	<a href="#">1697</a>	<a href="#">1871</a>	<a href="#">10100</a>	<a href="#">10331</a>	<a href="#">10804</a>	<a href="#">10992</a>
<a href="#">1095</a>	<a href="#">1533</a>	<a href="#">1703</a>	<a href="#">1874</a>	<a href="#">10101</a>	<a href="#">10333</a>	<a href="#">10805</a>	<a href="#">10993</a>
<a href="#">1097</a>	<a href="#">1534</a>	<a href="#">1706</a>	<a href="#">1878</a>	<a href="#">10109</a>	<a href="#">10337</a>	<a href="#">10838</a>	<a href="#">11004</a>
<a href="#">1102</a>	<a href="#">1536</a>	<a href="#">1719</a>	<a href="#">1886</a>	<a href="#">10113</a>	<a href="#">10368</a>	<a href="#">10839</a>	<a href="#">11005</a>
<a href="#">1107</a>	<a href="#">1547</a>	<a href="#">1720</a>	<a href="#">1895</a>	<a href="#">10125</a>	<a href="#">10369</a>	<a href="#">10840</a>	<a href="#">11006</a>
<a href="#">1108</a>	<a href="#">1551</a>	<a href="#">1723</a>	<a href="#">1900</a>	<a href="#">10126</a>	<a href="#">10388</a>	<a href="#">10841</a>	<a href="#">11007</a>
<a href="#">1109</a>	<a href="#">1552</a>	<a href="#">1728</a>	<a href="#">1901</a>	<a href="#">10131</a>	<a href="#">10412</a>	<a href="#">10842</a>	<a href="#">11025</a>
<a href="#">1110</a>	<a href="#">1553</a>	<a href="#">1730</a>	<a href="#">1905</a>	<a href="#">10137</a>	<a href="#">10426</a>	<a href="#">10843</a>	<a href="#">11026</a>
<a href="#">1112</a>	<a href="#">1554</a>	<a href="#">1731</a>	<a href="#">1921</a>	<a href="#">10138</a>	<a href="#">10444</a>	<a href="#">10844</a>	<a href="#">11027</a>
<a href="#">1113</a>	<a href="#">1568</a>	<a href="#">1732</a>	<a href="#">1923</a>	<a href="#">10150</a>	<a href="#">10446</a>	<a href="#">10845</a>	<a href="#">11028</a>
<a href="#">1120</a>	<a href="#">1569</a>	<a href="#">1736</a>	<a href="#">1926</a>	<a href="#">10168</a>	<a href="#">10448</a>	<a href="#">10846</a>	<a href="#">11029</a>
<a href="#">1150</a>	<a href="#">1571</a>	<a href="#">1741</a>	<a href="#">1942</a>	<a href="#">10183</a>	<a href="#">10450</a>	<a href="#">10847</a>	<a href="#">11030</a>
<a href="#">1176</a>	<a href="#">1572</a>	<a href="#">1747</a>	<a href="#">1949</a>	<a href="#">10192</a>	<a href="#">10453</a>	<a href="#">10848</a>	<a href="#">11035</a>
<a href="#">1185</a>	<a href="#">1577</a>	<a href="#">1759</a>	<a href="#">1959</a>	<a href="#">10198</a>	<a href="#">10454</a>	<a href="#">10849</a>	<a href="#">11041</a>
<a href="#">1195</a>	<a href="#">1581</a>	<a href="#">1761</a>	<a href="#">1966</a>	<a href="#">10204</a>	<a href="#">10456</a>	<a href="#">10850</a>	<a href="#">11042</a>
<a href="#">1208</a>	<a href="#">1583</a>	<a href="#">1762</a>	<a href="#">1967</a>	<a href="#">10210</a>	<a href="#">10461</a>	<a href="#">10851</a>	<a href="#">11043</a>
<a href="#">1230</a>	<a href="#">1585</a>	<a href="#">1763</a>	<a href="#">1972</a>	<a href="#">10211</a>	<a href="#">10464</a>	<a href="#">10852</a>	<a href="#">11044</a>
<a href="#">1232</a>	<a href="#">1586</a>	<a href="#">1766</a>	<a href="#">1973</a>	<a href="#">10212</a>	<a href="#">10468</a>	<a href="#">10853</a>	<a href="#">11045</a>

<u>1275</u>	<u>1589</u>	<u>1769</u>	<u>1978</u>	<u>10221</u>	<u>10482</u>	<u>10854</u>	<u>11046</u>
<u>1283</u>	<u>1596</u>	<u>1770</u>	<u>1984</u>	<u>10226</u>	<u>10483</u>	<u>10855</u>	<u>11047</u>
<u>1284</u>	<u>1597</u>	<u>1774</u>	<u>1987</u>	<u>10231</u>	<u>10492</u>	<u>10856</u>	<u>11048</u>
<u>1316</u>	<u>1598</u>	<u>1777</u>	<u>1988</u>	<u>10234</u>	<u>10493</u>	<u>10857</u>	<u>11059</u>
<u>1317</u>	<u>1605</u>	<u>1778</u>	<u>1989</u>	<u>10235</u>	<u>10495</u>	<u>10858</u>	<u>11060</u>
<u>1330</u>	<u>1610</u>	<u>1782</u>	<u>1990</u>	<u>10236</u>	<u>10496</u>	<u>10918</u>	<u>11080</u>
<u>1331</u>	<u>1617</u>	<u>1783</u>	<u>1992</u>	<u>10237</u>	<u>10498</u>	<u>10936</u>	<u>11081</u>
<u>1332</u>	<u>1618</u>	<u>1787</u>	<u>1999</u>	<u>10239</u>	<u>10499</u>	<u>10937</u>	<u>11082</u>
<u>1333</u>	<u>1624</u>	<u>1789</u>	<u>10002</u>	<u>10248</u>	<u>10501</u>	<u>10938</u>	<u>11083</u>
<u>1354</u>	<u>1631</u>	<u>1792</u>	<u>10005</u>	<u>10267</u>	<u>10504</u>	<u>10939</u>	<u>11084</u>
<u>1365</u>	<u>1635</u>	<u>1800</u>	<u>10012</u>	<u>10272</u>	<u>10515</u>	<u>10940</u>	<u>11085</u>
<u>1375</u>	<u>1637</u>	<u>1801</u>	<u>10014</u>	<u>10273</u>	<u>10525</u>	<u>10941</u>	<u>11130</u>
<u>1429</u>	<u>1638</u>	<u>1804</u>	<u>10023</u>	<u>10275</u>	<u>10533</u>	<u>10942</u>	<u>11211</u>
<u>1430</u>	<u>1640</u>	<u>1805</u>	<u>10027</u>	<u>10277</u>	<u>10545</u>	<u>10943</u>	<u>11212</u>
<u>1431</u>	<u>1641</u>	<u>1809</u>	<u>10038</u>	<u>10278</u>	<u>10551</u>	<u>10944</u>	<u>11213</u>
<u>1452</u>	<u>1642</u>	<u>1818</u>	<u>10040</u>	<u>10279</u>	<u>10553</u>	<u>10945</u>	<u>11214</u>
<u>1453</u>	<u>1643</u>	<u>1825</u>	<u>10041</u>	<u>10283</u>	<u>10554</u>	<u>10946</u>	<u>11215</u>
<u>1472</u>	<u>1645</u>	<u>1827</u>	<u>10043</u>	<u>10286</u>	<u>10587</u>	<u>10947</u>	<u>11216</u>
<u>1478</u>	<u>1646</u>	<u>1828</u>	<u>10050</u>	<u>10290</u>	<u>10602</u>	<u>10948</u>	<u>11217</u>
<u>1486</u>	<u>1647</u>	<u>1829</u>	<u>10053</u>	<u>10298</u>	<u>10603</u>	<u>10949</u>	<u>11254</u>
<u>1489</u>	<u>1649</u>	<u>1830</u>	<u>10057</u>	<u>10302</u>	<u>10668</u>	<u>10950</u>	<u>11255</u>
<u>1490</u>	<u>1651</u>	<u>1833</u>	<u>10059</u>	<u>10306</u>	<u>10669</u>	<u>10951</u>	
<u>1494</u>	<u>1670</u>	<u>1835</u>	<u>10063</u>	<u>10308</u>	<u>10794</u>	<u>10952</u>	

**Multiple-conductor, thermoplastic insulation.**

<u>2092</u>	<u>2552</u>	<u>2956</u>	<u>20280</u>	<u>20851</u>	<u>21126</u>	<u>21324</u>	<u>21469</u>
<u>2093</u>	<u>2554</u>	<u>2957</u>	<u>20292</u>	<u>20854</u>	<u>21130</u>	<u>21325</u>	<u>21472</u>
<u>2094</u>	<u>2562</u>	<u>2960</u>	<u>20317</u>	<u>20855</u>	<u>21137</u>	<u>21326</u>	<u>21473</u>
<u>2095</u>	<u>2569</u>	<u>2969</u>	<u>20350</u>	<u>20866</u>	<u>21139</u>	<u>21327</u>	<u>21474</u>
<u>2096</u>	<u>2570</u>	<u>2975</u>	<u>20351</u>	<u>20868</u>	<u>21140</u>	<u>21328</u>	<u>21475</u>
<u>2097</u>	<u>2574</u>	<u>2990</u>	<u>20352</u>	<u>20911</u>	<u>21141</u>	<u>21329</u>	<u>21476</u>
<u>2101</u>	<u>2576</u>	<u>2992</u>	<u>20353</u>	<u>20912</u>	<u>21142</u>	<u>21330</u>	<u>21492</u>
<u>2102</u>	<u>2584</u>	<u>2996</u>	<u>20379</u>	<u>20921</u>	<u>21143</u>	<u>21338</u>	<u>21503</u>
<u>2103</u>	<u>2586</u>	<u>20002</u>	<u>20382</u>	<u>20936</u>	<u>21145</u>	<u>21398</u>	<u>21504</u>
<u>2151</u>	<u>2587</u>	<u>20007</u>	<u>20407</u>	<u>20939</u>	<u>21149</u>	<u>21399</u>	<u>21505</u>
<u>2180</u>	<u>2589</u>	<u>20008</u>	<u>20410</u>	<u>20940</u>	<u>21153</u>	<u>21400</u>	<u>21506</u>
<u>2192</u>	<u>2590</u>	<u>20009</u>	<u>20411</u>	<u>20948</u>	<u>21154</u>	<u>21401</u>	<u>21507</u>
<u>2305</u>	<u>2598</u>	<u>20010</u>	<u>20446</u>	<u>20954</u>	<u>21161</u>	<u>21402</u>	<u>21508</u>
<u>2343</u>	<u>2611</u>	<u>20011</u>	<u>20460</u>	<u>20957</u>	<u>21165</u>	<u>21403</u>	<u>21509</u>
<u>2344</u>	<u>2612</u>	<u>20021</u>	<u>20468</u>	<u>20970</u>	<u>21179</u>	<u>21404</u>	<u>21510</u>
<u>2366</u>	<u>2614</u>	<u>20022</u>	<u>20475</u>	<u>20989</u>	<u>21198</u>	<u>21405</u>	<u>21511</u>
<u>2405</u>	<u>2651</u>	<u>20034</u>	<u>20517</u>	<u>21016</u>	<u>21223</u>	<u>21406</u>	<u>21512</u>
<u>2428</u>	<u>2661</u>	<u>20058</u>	<u>20519</u>	<u>21025</u>	<u>21253</u>	<u>21407</u>	<u>21515</u>

<u>2444</u>	<u>2662</u>	<u>20066</u>	<u>20524</u>	<u>21026</u>	<u>21283</u>	<u>21408</u>	<u>21516</u>
<u>2448</u>	<u>2668</u>	<u>20080</u>	<u>20541</u>	<u>21027</u>	<u>21301</u>	<u>21409</u>	<u>21517</u>
<u>2461</u>	<u>2679</u>	<u>20095</u>	<u>20549</u>	<u>21028</u>	<u>21303</u>	<u>21410</u>	<u>21518</u>
<u>2462</u>	<u>2717</u>	<u>20097</u>	<u>20554</u>	<u>21036</u>	<u>21304</u>	<u>21411</u>	<u>21520</u>
<u>2464</u>	<u>2725</u>	<u>20099</u>	<u>20567</u>	<u>21047</u>	<u>21305</u>	<u>21412</u>	<u>21570</u>
<u>2468</u>	<u>2733</u>	<u>20120</u>	<u>20604</u>	<u>21064</u>	<u>21306</u>	<u>21413</u>	<u>21571</u>
<u>2473</u>	<u>2734</u>	<u>20153</u>	<u>20620</u>	<u>21069</u>	<u>21307</u>	<u>21414</u>	<u>21631</u>
<u>2474</u>	<u>2740</u>	<u>20170</u>	<u>20640</u>	<u>21073</u>	<u>21308</u>	<u>21415</u>	<u>21632</u>
<u>2481</u>	<u>2789</u>	<u>20195</u>	<u>20644</u>	<u>21074</u>	<u>21309</u>	<u>21416</u>	<u>21633</u>
<u>2482</u>	<u>2791</u>	<u>20197</u>	<u>20694</u>	<u>21080</u>	<u>21310</u>	<u>21451</u>	<u>21634</u>
<u>2483</u>	<u>2833</u>	<u>20201</u>	<u>20698</u>	<u>21088</u>	<u>21311</u>	<u>21452</u>	<u>21688</u>
<u>2493</u>	<u>2835</u>	<u>20233</u>	<u>20711</u>	<u>21089</u>	<u>21313</u>	<u>21453</u>	<u>21689</u>
<u>2497</u>	<u>2844</u>	<u>20234</u>	<u>20721</u>	<u>21099</u>	<u>21314</u>	<u>21454</u>	<u>21690</u>
<u>2500</u>	<u>2851</u>	<u>20235</u>	<u>20722</u>	<u>21100</u>	<u>21315</u>	<u>21455</u>	<u>21691</u>
<u>2501</u>	<u>2854</u>	<u>20236</u>	<u>20723</u>	<u>21101</u>	<u>21316</u>	<u>21456</u>	<u>21692</u>
<u>2509</u>	<u>2877</u>	<u>20251</u>	<u>20733</u>	<u>21115</u>	<u>21317</u>	<u>21457</u>	<u>21693</u>
<u>2514</u>	<u>2907</u>	<u>20253</u>	<u>20744</u>	<u>21116</u>	<u>21318</u>	<u>21458</u>	<u>21776</u>
<u>2517</u>	<u>2918</u>	<u>20254</u>	<u>20745</u>	<u>21117</u>	<u>21319</u>	<u>21460</u>	
<u>2522</u>	<u>2919</u>	<u>20276</u>	<u>20749</u>	<u>21118</u>	<u>21320</u>	<u>21461</u>	
<u>2547</u>	<u>2935</u>	<u>20278</u>	<u>20778</u>	<u>21119</u>	<u>21322</u>	<u>21462</u>	
<u>2551</u>	<u>2950</u>	<u>20279</u>	<u>20850</u>	<u>21120</u>	<u>21323</u>	<u>21468</u>	

**Single-conductor, thermoset insulation.**

<u>3122</u>	<u>3273</u>	<u>3317</u>	<u>3375</u>	<u>3413</u>	<u>3454</u>	<u>3502</u>	<u>3611</u>
<u>3135</u>	<u>3275</u>	<u>3320</u>	<u>3376</u>	<u>3415</u>	<u>3456</u>	<u>3505</u>	<u>3612</u>
<u>3137</u>	<u>3281</u>	<u>3321</u>	<u>3377</u>	<u>3416</u>	<u>3458</u>	<u>3506</u>	<u>3613</u>
<u>3167</u>	<u>3282</u>	<u>3331</u>	<u>3378</u>	<u>3417</u>	<u>3459</u>	<u>3511</u>	<u>3619</u>
<u>3173</u>	<u>3286</u>	<u>3336</u>	<u>3379</u>	<u>3423</u>	<u>3463</u>	<u>3558</u>	<u>3623</u>
<u>3182</u>	<u>3287</u>	<u>3338</u>	<u>3381</u>	<u>3424</u>	<u>3464</u>	<u>3564</u>	<u>3626</u>
<u>3194</u>	<u>3288</u>	<u>3343</u>	<u>3382</u>	<u>3432</u>	<u>3469</u>	<u>3565</u>	<u>3631</u>
<u>3195</u>	<u>3289</u>	<u>3344</u>	<u>3383</u>	<u>3433</u>	<u>3470</u>	<u>3567</u>	<u>3633</u>
<u>3196</u>	<u>3290</u>	<u>3345</u>	<u>3384</u>	<u>3435</u>	<u>3473</u>	<u>3569</u>	<u>3635</u>
<u>3199</u>	<u>3295</u>	<u>3346</u>	<u>3385</u>	<u>3436</u>	<u>3475</u>	<u>3578</u>	<u>3649</u>
<u>3236</u>	<u>3296</u>	<u>3347</u>	<u>3386</u>	<u>3437</u>	<u>3480</u>	<u>3581</u>	<u>3652</u>
<u>3239</u>	<u>3297</u>	<u>3348</u>	<u>3387</u>	<u>3438</u>	<u>3481</u>	<u>3592</u>	<u>3656</u>
<u>3247</u>	<u>3298</u>	<u>3351</u>	<u>3393</u>	<u>3439</u>	<u>3485</u>	<u>3593</u>	<u>3657</u>
<u>3248</u>	<u>3299</u>	<u>3352</u>	<u>3397</u>	<u>3440</u>	<u>3486</u>	<u>3594</u>	<u>3666</u>
<u>3249</u>	<u>3300</u>	<u>3358</u>	<u>3398</u>	<u>3443</u>	<u>3491</u>	<u>3596</u>	<u>3674</u>
<u>3250</u>	<u>3302</u>	<u>3363</u>	<u>3399</u>	<u>3446</u>	<u>3492</u>	<u>3597</u>	<u>3681</u>
<u>3265</u>	<u>3310</u>	<u>3364</u>	<u>3401</u>	<u>3447</u>	<u>3493</u>	<u>3598</u>	<u>3687</u>
<u>3266</u>	<u>3312</u>	<u>3366</u>	<u>3402</u>	<u>3448</u>	<u>3495</u>	<u>3599</u>	<u>3688</u>
<u>3271</u>	<u>3314</u>	<u>3368</u>	<u>3406</u>	<u>3452</u>	<u>3496</u>	<u>3607</u>	<u>3817</u>

<a href="#">3272</a>	<a href="#">3315</a>	<a href="#">3373</a>	<a href="#">3409</a>	<a href="#">3453</a>	<a href="#">3500</a>	<a href="#">3610</a>	<a href="#">3885</a>
<b>Multiple-conductor, thermoset insulation.</b>							
<a href="#">4258</a>	<a href="#">4289</a>	<a href="#">4313</a>	<a href="#">4338</a>	<a href="#">4399</a>	<a href="#">4417</a>	<a href="#">4468</a>	<a href="#">4478</a>
<a href="#">4259</a>	<a href="#">4290</a>	<a href="#">4314</a>	<a href="#">4359</a>	<a href="#">4400</a>	<a href="#">4435</a>	<a href="#">4469</a>	<a href="#">4486</a>
<a href="#">4260</a>	<a href="#">4311</a>	<a href="#">4319</a>	<a href="#">4384</a>	<a href="#">4401</a>	<a href="#">4436</a>	<a href="#">4470</a>	<a href="#">4579</a>
<a href="#">4288</a>	<a href="#">4312</a>	<a href="#">4320</a>	<a href="#">4398</a>	<a href="#">4407</a>	<a href="#">4465</a>	<a href="#">4471</a>	
<b>Single and multiple-conductor specialty items.</b>							
<a href="#">5291</a>	<a href="#">5292</a>	<a href="#">5352</a>	<a href="#">5361</a>				

Marking: Company name or tradename "LTK" , voltage rating, temperature rating, conductor size, conductor material if other than copper, and use.

Last Updated on 2015-01-09

[Questions?](#)

[Print this page](#)

[Terms of Use](#)

[Page Top](#)

◆ 2015 UL LLC

The appearance of a company's name or product in this database does not in itself assure that products so identified have been manufactured under UL's Follow-Up Service. Only those products bearing the UL Mark should be considered to be Certified and covered under UL's Follow-Up Service. Always look for the Mark on the product.

UL permits the reproduction of the material contained in the Online Certification Directory subject to the following conditions: 1. The Guide Information, Assemblies, Constructions, Designs, Systems, and/or Certifications (files) must be presented in their entirety and in a non-misleading manner, without any manipulation of the data (or drawings). 2. The statement "Reprinted from the Online Certifications Directory with permission from UL" must appear adjacent to the extracted material. In addition, the reprinted material must include a copyright notice in the following format: "© 2015 UL LLC".



# Test Report

**Report No.** SCL01G025629001

Page 1 of 5

**Applicant** HUI ZHOU ZHEN XIONG COPPER CONDUCTOR CO.,LTD/ HUIZHOU HUASHENG ELECTRONIC WIRE&CABLE CO.,LTD

**Address** NO.5 SECTION,DAXIN INDUSTRIAL PARK,CHENJIANG STREET,ZHONGKAI HI-TECH INDUSTRIAL DEVELOPMENT ZONE,HUIZHOU CITY,GUANGDONG PROVINCE

**The following sample(s) and sample information was/were submitted and identified by/on the behalf of the client**

Sample Name Tinned Copper Wire  
Material Cu, Sn  
Sample Received Date Aug. 11, 2014  
Testing Period Aug. 11, 2014 to Aug. 14, 2014

**Test Requested** As specified by client, to test Lead (Pb), Cadmium (Cd), Mercury (Hg), Hexavalent Chromium(Cr(VI)), Polybrominated Biphenyl(PBBs), Polybrominated Diphenyl Ethers(PBDEs) in the submitted sample(s).

**Test Method** Please refer to the following page(s).

**Test Result(s)** Please refer to the following page(s).

\*\*\*\*\*  
**Conclusion**

Tested Sample	According to directive	Result
Submitted Sample	2011/65/EU*	Pass

\*\*\*\*\*

\*2011/65/EU is a new version of RoHS Directive (2002/95/EC), which focuses on restriction of the use of certain hazardous substances (Lead(Pb), Cadmium(Cd), Mercury(Hg), Hexavalent Chromium(Cr(VI)), Polybrominated Biphenyls(PBBs), Polybrominated Diphenyl Ethers(PBDEs)) in electrical and electronic equipment.

Pass means that the results shown on the report do not exceed the limits set by RoHS Directive 2011/65/EU.

Tested by

*Rick Lin*

Reviewed by

*Vangar He*



approved by

*Danny Liu*

Date

Aug. 14, 2014

Danny Liu  
Technical Manager

No. R101225182

Centre Testing International (Shenzhen) Co., Ltd. Hongwei Industrial Zone, Bao'an 70 District, Shenzhen, Guangdong, China

# Test Report

**Report No.** SCL01G025629001

Page 2 of 5

**Test Method**

Test Item(s)	Test Method	Measured Equipment(s)
Lead (Pb)	IEC 62321-5:2013 Ed.1.0	ICP-OES
Cadmium (Cd)	IEC 62321-5:2013 Ed.1.0	ICP-OES
Mercury (Hg)	IEC 62321-4:2013 Ed.1.0	ICP-OES
Hexavalent Chromium(Cr(VI))	IEC 62321:2008 Ed.1 Annex B	UV-Vis
Polybrominated Biphenyl(PBBs)	IEC 62321:2008 Ed.1 Annex A	GC-MS
Polybrominated Diphenyl Ethers(PBDEs)	IEC 62321:2008 Ed.1 Annex A	GC-MS

**Test Result(s)**

Tested Item(s)	Result	MDL	Limit of Directive 2011/65/EU
Lead (Pb)	N.D.	2 mg/kg	1000 mg/kg
Cadmium (Cd)	N.D.	2 mg/kg	100 mg/kg
Mercury (Hg)	N.D.	2 mg/kg	1000 mg/kg
Hexavalent Chromium(Cr(VI))	Negative	/	1000 mg/kg

Tested Item(s)	Result	MDL	Limit of Directive 2011/65/EU
<b>Polybrominated Biphenyl(PBBs)</b>			
Monobromobiphenyl	N.D.	5 mg/kg	1000 mg/kg
Dibromobiphenyl	N.D.	5 mg/kg	
Tribromobiphenyl	N.D.	5 mg/kg	
Tetrabromobiphenyl	N.D.	5 mg/kg	
Pentabromobiphenyl	N.D.	5 mg/kg	
Hexabromobiphenyl	N.D.	5 mg/kg	
Heptabromobiphenyl	N.D.	5 mg/kg	
Octabromobiphenyl	N.D.	5 mg/kg	
Nonabromobiphenyl	N.D.	5 mg/kg	
Decabromobiphenyl	N.D.	5 mg/kg	

# Test Report

Report No. SCL01G025629001

Page 3 of 5

Tested Item(s)	Result	MDL	Limit of Directive 2011/65/EU
<b>Polybrominated Diphenyl Ethers(PBDEs)</b>			
Monobromodiphenyl ether	N.D.	5 mg/kg	1000 mg/kg
Dibromodiphenyl ether	N.D.	5 mg/kg	
Tribromodiphenyl ether	N.D.	5 mg/kg	
Tetrabromodiphenyl ether	N.D.	5 mg/kg	
Pentabromodiphenyl ether	N.D.	5 mg/kg	
Hexabromodiphenyl ether	N.D.	5 mg/kg	
Heptabromodiphenyl ether	N.D.	5 mg/kg	
Octabromodiphenyl ether	N.D.	5 mg/kg	
Nonabromodiphenyl ether	N.D.	5 mg/kg	
Decabromodiphenyl ether	N.D.	5 mg/kg	

**Tested Sample/Part Description** Metal wire with silvery plating

**Note:** The sample(s) had been dissolved totally tested for Lead, Cadmium, Mercury.

-MDL = Method Detection Limit

-N.D. = Not Detected (&lt;MDL )

-mg/kg = ppm = parts per million

 -Negative = Absence of Cr(VI) , the detected Cr(VI) concentration in the boiling water extraction solution is less than 0.02 mg/kg with 50cm<sup>2</sup> sample surface area used.

# Test Report

Report No. SCL01G025629001

Page 4 of 5

## Test Process

### 1. Lead (Pb), Cadmium (Cd)

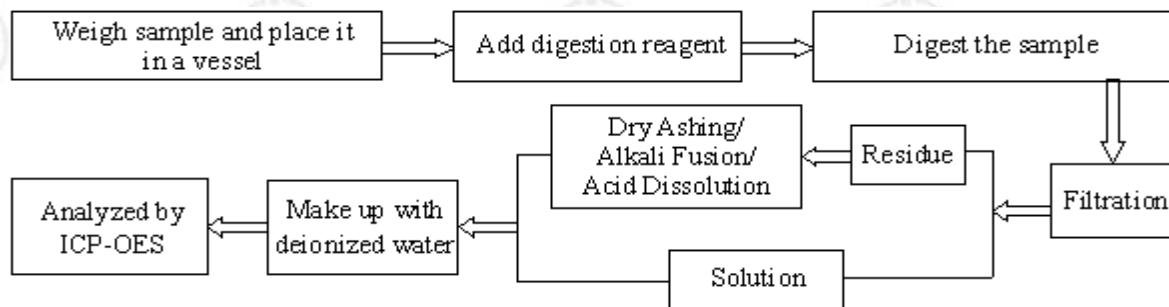

### 2. Mercury (Hg)

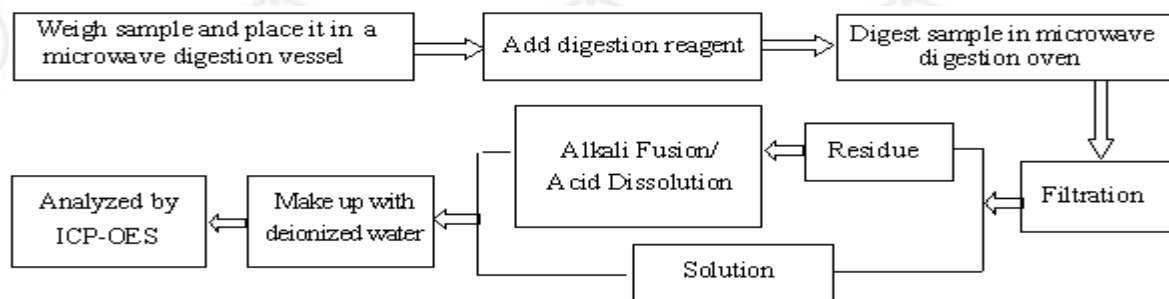

### 3. Hexavalent Chromium(Cr(VI))

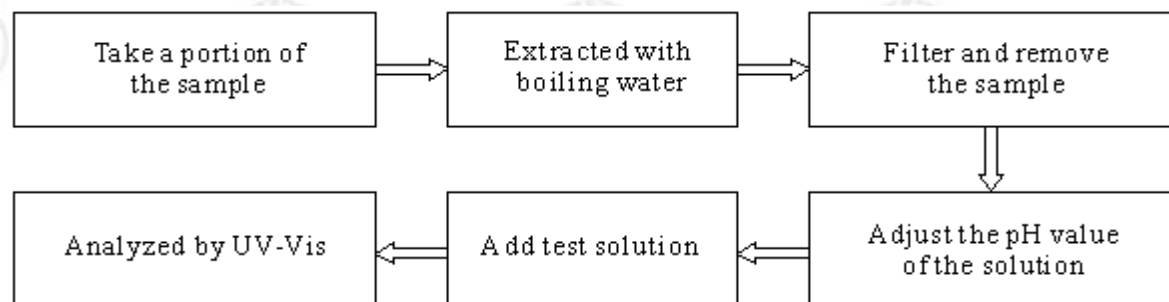

### 4. Polybrominated Biphenyl(PBBs) , Polybrominated Diphenyl Ethers(PBDEs)

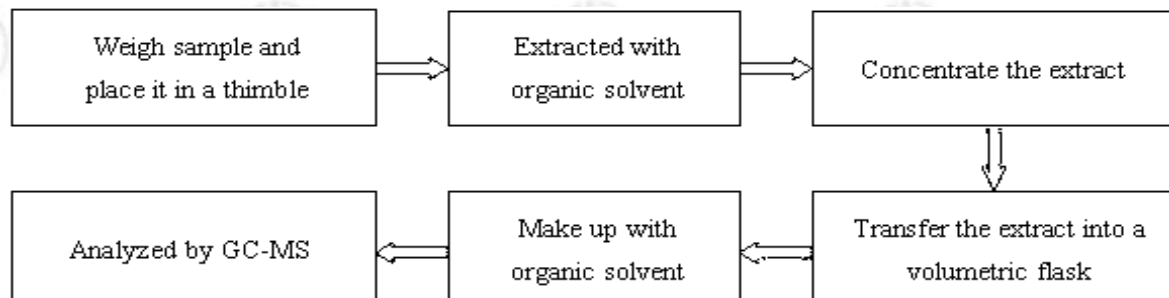

# Test Report

Report No. SCL01G025629001

Page 5 of 5

## Photo(s) of the sample(s)



\*\*\* End of report \*\*\*

The test report is effective only with both signature and specialized stamp. The result(s) shown in this report refer only to the sample(s) tested. Without written approval of CTI, this report can't be reproduced except in full.



# 检测报告 Test Report

报告编号 SCL01H032440002E  
Report No. SCL01H032440002E

第 1 页 共 10 页  
Page 1 of 10

申请单位 乐庭电线工业(惠州)有限公司  
Applicant LTK ELECTRIC WIRE (HUIZHOU) LTD  
地 址 广东省惠州市陈江德赛第三工业区  
Address DESAY 3RD INDUSTRIAL DISTRICT, ZHONGKAI ROAD CHENJIANG TOWN,  
HUIZHOU CITY GUANGDONG PROVINCE ,P.R.C

以下测试之样品及样品信息由申请者提供并确认

The following sample(s) and sample information was/were submitted and identified by/on the behalf of the client

样品名称 318M  
Sample Name 318M  
样品型号 318M  
Part No. 318M  
样品颜色 灰色  
Color Gray  
材料名称 色粉  
Material Powder  
样品接收日期 2015.04.30  
Sample Received Date Apr. 30, 2015  
样品检测日期 2015.04.30-2015.05.06  
Testing Period Apr. 30, 2015 to May. 6, 2015

检测要求 根据客户要求, 对所提交样品中的铅(Pb), 镉(Cd), 汞(Hg), 六价铬(Cr(VI)), 多溴联苯(PBBs), 多溴二苯醚(PBDEs), 六溴环十二烷(HBCDD), 邻苯二甲酸酯进行测试。

Test Requested As specified by client, to test Lead (Pb), Cadmium (Cd), Mercury (Hg), Hexavalent Chromium(Cr(VI)), Polybrominated Biphenyl(PBBs), Polybrominated Diphenyl Ethers(PBDEs), Hexabromocyclododecane (HBCDD), Phthalates in the submitted sample(s).

检测依据/检测结果 请参见下页。  
Test Method/Test Result(s) Please refer to the following page(s).

主 检 Fancy  
Tested by \_\_\_\_\_

审 核 Cathy  
Reviewed by \_\_\_\_\_

批 准 Danny Liu  
Approved by \_\_\_\_\_

日 期 2015.05.06  
Date \_\_\_\_\_

Danny Liu  
Technical Manager

No. R179751257

深圳市华测检测技术股份有限公司 广东省深圳市宝安区70区鸿威工业园  
Centre Testing International (Shenzhen) Co., Ltd. Hongwei Industrial Zone, Bao'an 70 District, Shenzhen, Guangdong, China

# 检测报告 Test Report

报告编号 SCL01H032440002E  
Report No. SCL01H032440002E

第 2 页 共 10 页  
Page 2 of 10

\*\*\*\*\*

## 结论 Conclusion

测试样品 Tested Sample	依据指令 According to directive	结果 Result
提交样品 Submitted Sample	2011/65/EU*	合格 Pass

\*\*\*\*\*

\*2011/65/EU为欧盟RoHS指令(2002/95/EC)的重订指令。该指令对电子电器产品中的特定有毒有害物质(铅(Pb), 镉(Cd), 汞(Hg), 六价铬(Cr(VI)), 多溴联苯(PBBs), 多溴二苯醚(PBDEs))限制使用。  
合格表示检测结果不超过欧盟RoHS指令2011/65/EU要求的限值。

\*2011/65/EU is a new version of RoHS Directive (2002/95/EC), which focuses on restriction of the use of certain hazardous substances (Lead(Pb), Cadmium(Cd), Mercury(Hg), Hexavalent Chromium(Cr(VI)), Polybrominated Biphenyls(PBBs), Polybrominated Diphenyl Ethers(PBDEs)) in electrical and electronic equipment.

Pass means that the results shown on the report do not exceed the limits set by RoHS Directive 2011/65/EU.



# 检测报告 Test Report

报告编号 SCL01H032440002E  
Report No. SCL01H032440002E

第 3 页 共 10 页  
Page 3 of 10

## 检测依据 Test Method

测试项目 Test Item(s)	测试方法 Test Method	测试仪器 Measured Equipment(s)
铅(Pb) Lead (Pb)	IEC 62321-5:2013 Ed.1.0	ICP-OES
镉(Cd) Cadmium (Cd)	IEC 62321-5:2013 Ed.1.0	ICP-OES
汞(Hg) Mercury (Hg)	IEC 62321-4:2013 Ed.1.0	ICP-OES
六价铬(Cr(VI)) Hexavalent Chromium(Cr(VI))	IEC 62321:2008 Ed.1 Annex C	UV-Vis
多溴联苯(PBBs) Polybrominated Biphenyl(PBBs)	IEC 62321:2008 Ed.1 Annex A	GC-MS
多溴二苯醚(PBDEs) Polybrominated Diphenyl Ethers(PBDEs)	IEC 62321:2008 Ed.1 Annex A	GC-MS
六溴环十二烷(HBCDD) Hexabromocyclododecane (HBCDD)	参考US EPA 3540C:1996 & US EPA 8270D:2007 Refer to US EPA 3540C:1996 & US EPA 8270D:2007	GC-MS
邻苯二甲酸酯 Phthalates	参考EN 14372:2004(E) Refer to EN 14372:2004(E)	GC-MS

## 检测结果 Test Result(s)

测试项目 Test Item(s)	结果 Result	方法检出限 MDL	2011/65/EU指令限值 Limit of Directive 2011/65/EU
铅(Pb) Lead (Pb)	N.D.	2 mg/kg	1000 mg/kg
镉(Cd) Cadmium (Cd)	N.D.	2 mg/kg	100 mg/kg
汞(Hg) Mercury (Hg)	N.D.	2 mg/kg	1000 mg/kg
六价铬(Cr(VI)) Hexavalent Chromium (Cr(VI))	N.D.	2 mg/kg	1000 mg/kg

# 检测报告

## Test Report

报告编号 SCL01H032440002E  
Report No. SCL01H032440002E

第 4 页 共 10 页  
Page 4 of 10

测试项目 Test Item(s)	结果 Result	方法检出限 MDL	2011/65/EU指令限值 Limit of Directive 2011/65/EU
<b>多溴联苯(PBBs) Polybrominated Biphenyl(PBBs)</b>			
一溴联苯 Monobromobiphenyl	N.D.	5 mg/kg	1000 mg/kg
二溴联苯 Dibromobiphenyl	N.D.	5 mg/kg	
三溴联苯 Tribromobiphenyl	N.D.	5 mg/kg	
四溴联苯 Tetrabromobiphenyl	N.D.	5 mg/kg	
五溴联苯 Pentabromobiphenyl	N.D.	5 mg/kg	
六溴联苯 Hexabromobiphenyl	N.D.	5 mg/kg	
七溴联苯 Heptabromobiphenyl	N.D.	5 mg/kg	
八溴联苯 Octabromobiphenyl	N.D.	5 mg/kg	
九溴联苯 Nonabromobiphenyl	N.D.	5 mg/kg	
十溴联苯 Decabromobiphenyl	N.D.	5 mg/kg	

# 检测报告 Test Report

报告编号 SCL01H032440002E  
Report No. SCL01H032440002E

第 5 页 共 10 页  
Page 5 of 10

测试项目 Test Item(s)	结果 Result	方法检出限 MDL	2011/65/EU指令限值 Limit of Directive 2011/65/EU
<b>多溴二苯醚(PBDEs) Polybrominated Diphenyl Ethers(PBDEs)</b>			
一溴二苯醚 Monobromodiphenyl ether	N.D.	5 mg/kg	1000 mg/kg
二溴二苯醚 Dibromodiphenyl ether	N.D.	5 mg/kg	
三溴二苯醚 Tribromodiphenyl ether	N.D.	5 mg/kg	
四溴二苯醚 Tetrabromodiphenyl ether	N.D.	5 mg/kg	
五溴二苯醚 Pentabromodiphenyl ether	N.D.	5 mg/kg	
六溴二苯醚 Hexabromodiphenyl ether	N.D.	5 mg/kg	
七溴二苯醚 Heptabromodiphenyl ether	N.D.	5 mg/kg	
八溴二苯醚 Octabromodiphenyl ether	N.D.	5 mg/kg	
九溴二苯醚 Nonabromodiphenyl ether	N.D.	5 mg/kg	
十溴二苯醚 Decabromodiphenyl ether	N.D.	5 mg/kg	
测试项目 Test Item(s)	结果 Result	方法检出限 MDL	
六溴环十二烷(HBCDD) Hexabromocyclododecane (HBCDD)	N.D.	5 mg/kg	

# 检测报告 Test Report

报告编号 SCL01H032440002E  
Report No. SCL01H032440002E

第 6 页 共 10 页  
Page 6 of 10

测试项目 Tested Item(s)	结果 Result	方法检出限 MDL
<b>邻苯二甲酸酯 Phthalates</b>		
邻苯二甲酸二正丁酯( <b>DBP</b> ) Dibutyl phthalate(DBP) CAS#:84-74-2	N.D.	50 mg/kg
邻苯二甲酸丁基苄酯( <b>BBP</b> ) Butylbenzyl phthalate(BBP) CAS#:85-68-7	N.D.	50 mg/kg
邻苯二甲酸二(2-乙基己基)酯( <b>DEHP</b> ) Di-2-ethylhexyl phthalate(DEHP) CAS#:117-81-7	N.D.	50 mg/kg

测试样品/ 部位描述 灰色粉末  
Tested Sample/Part Description Gray powder

备注: 对于检测铅, 镉, 汞之样品已完全溶解。

-N.D. = 未检出 (小于方法检出限)

-mg/kg= ppm = 百万分之一

**Remark: The sample(s) had been dissolved totally tested for Lead, Cadmium, Mercury.**

-MDL = Method Detection Limit

-N.D. = Not Detected (<MDL )

-mg/kg = ppm = parts per million

# 检测报告 Test Report

报告编号 SCL01H032440002E  
Report No. SCL01H032440002E

第 7 页 共 10 页  
Page 7 of 10

## 检测流程 Test Process

### 1. 铅(Pb), 镉(Cd) Lead (Pb), Cadmium (Cd)

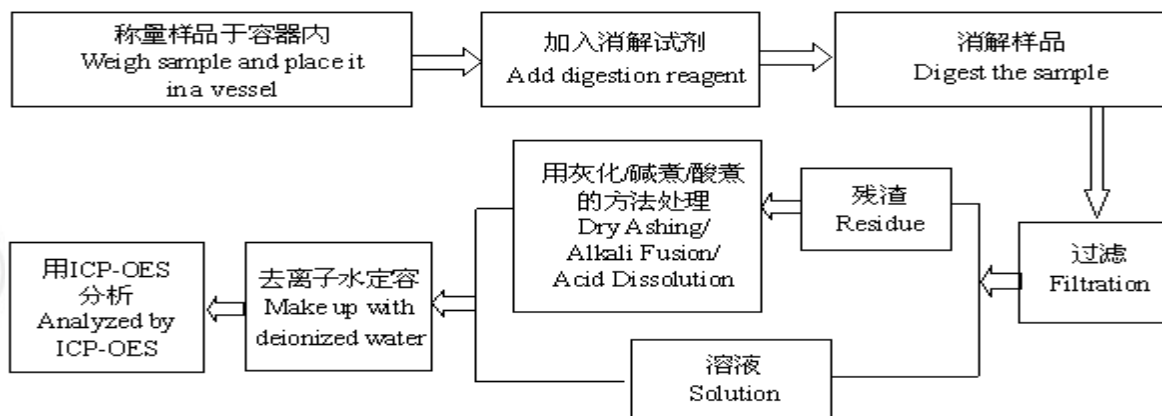

### 2. 汞(Hg) Mercury (Hg)

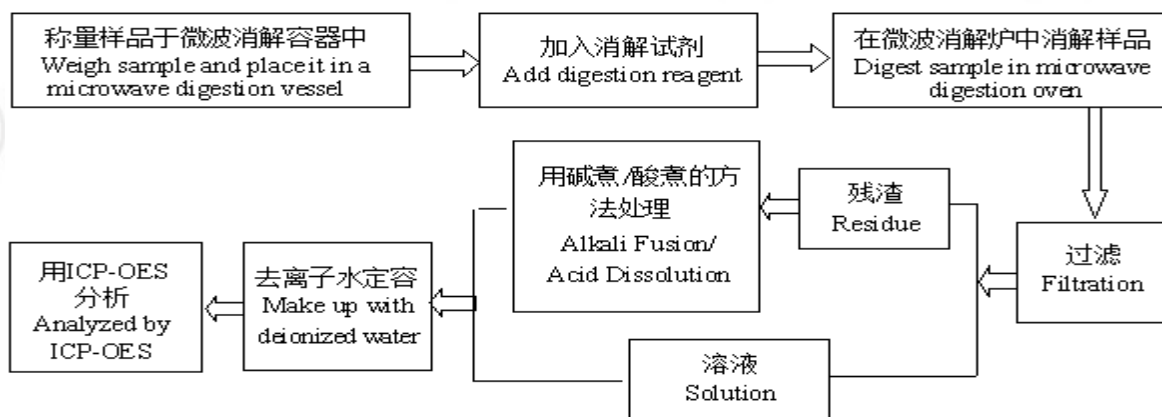



# 检测报告 Test Report

报告编号 SCL01H032440002E  
Report No. SCL01H032440002E

第 8 页 共 10 页  
Page 8 of 10

### 3. 六价铬(Cr(VI)) Hexavalent Chromium(Cr(VI))

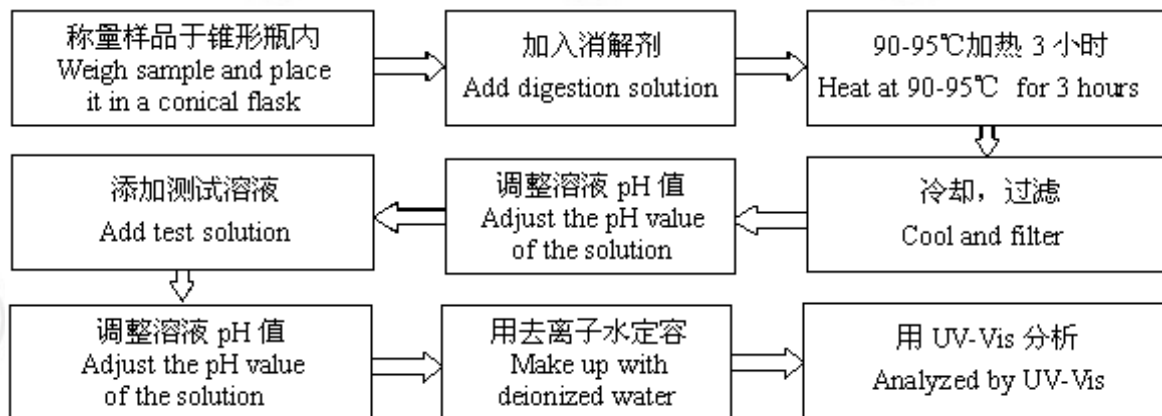

### 4. 邻苯二甲酸酯 Phthalates

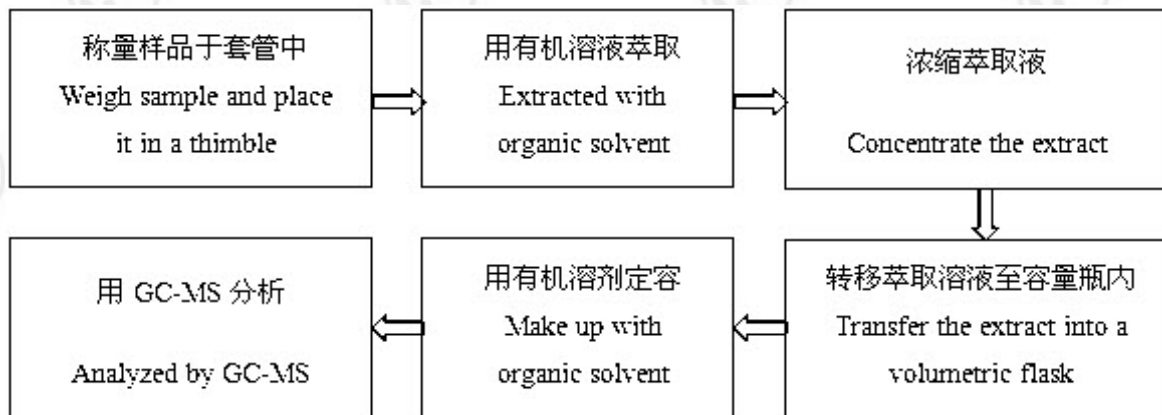

### 5. 多溴联苯(PBBs), 多溴二苯醚(PBDEs) Polybrominated Biphenyl(PBBs), Polybrominated Diphenyl Ethers(PBDEs)

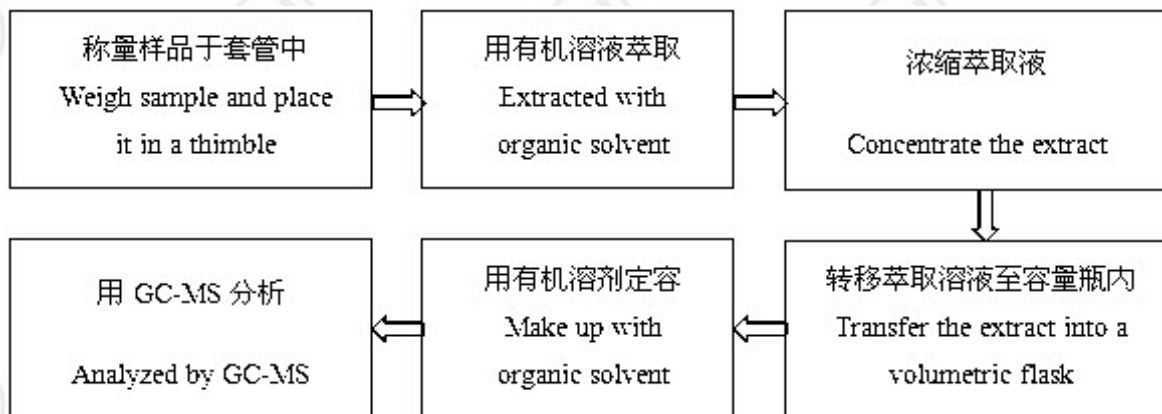

# 检测报告 Test Report

报告编号 SCL01H032440002E  
Report No. SCL01H032440002E

第 9 页 共 10 页  
Page 9 of 10

6. 六溴环十二烷(HBCDD)  
Hexabromocyclododecane (HBCDD)

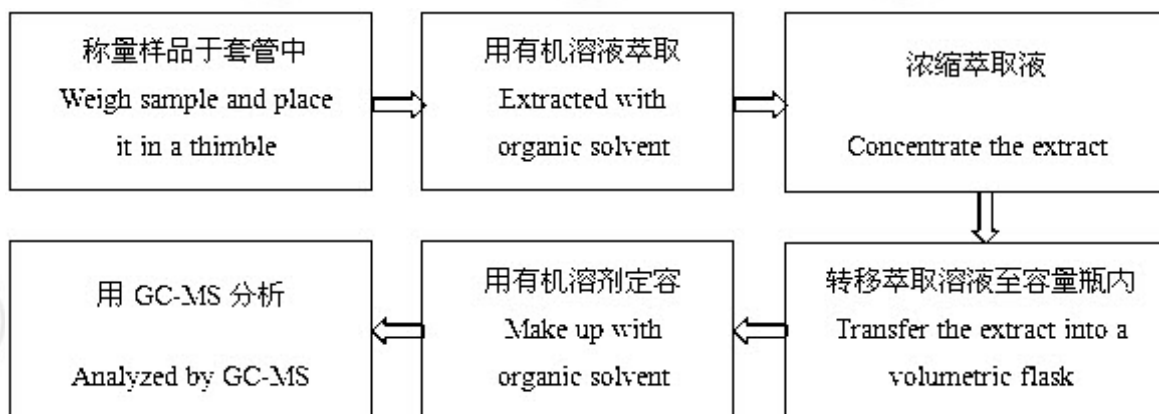



# 检测报告 Test Report

报告编号 SCL01H032440002E  
Report No. SCL01H032440002E

第 10 页 共 10 页  
Page 10 of 10

## 样品图片 Photo(s) of the sample(s)



\*\*\* 报告结束\*\*\*  
\*\*\* End of report \*\*\*

检测报告无批准人签字及“报告专用章”无效，本报告检测结果仅对受测样品负责。未经CTI书面同意，不得部分复制本报告。

The test report is effective only with both signature and specialized stamp. The result(s) shown in this report refer only to the sample(s) tested. Without written approval of CTI, this report can't be reproduced except in full.



# 產品圖

变更标记 REV. LTR.	日期 DATE	变更依据 REVISION ORIGINOR	签名 SIGN	核准 APPROVED	精度 CLASS	公差 TOLERANCE			
						A	B	C	D
△2	2005/6/16	依2變更	寧夢秋						
△3	2005/8/11	依實物變更	寧夢秋						

未注尺寸公差	±0.10
未注孔徑公差	
未注角度公差	±1°

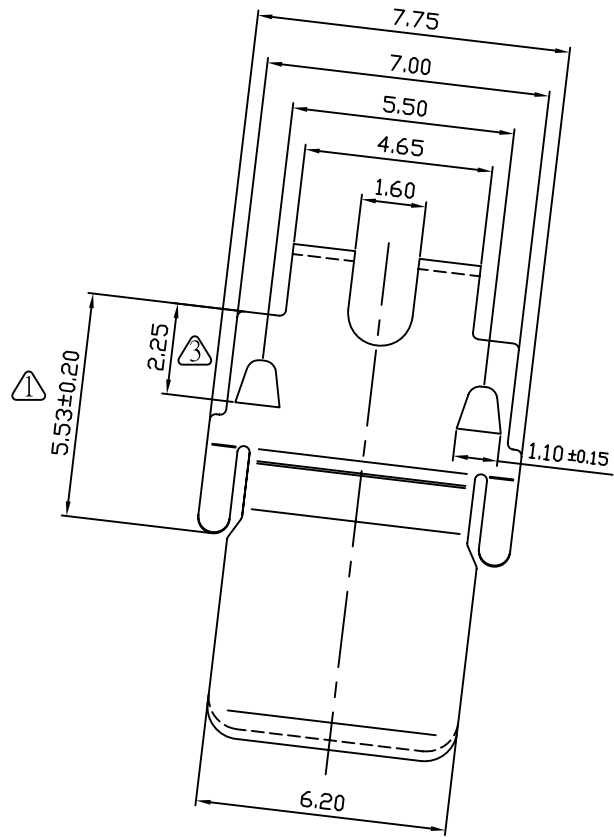

SEC B-B

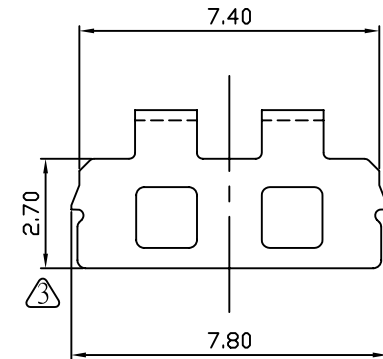
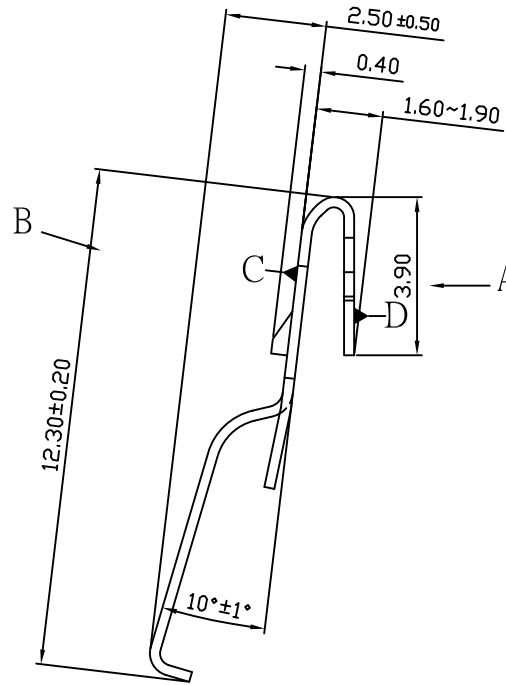

SEC A-A

注:

1. 未注毛邊高度0.05以內.
2. SEC B-B以"C"面為基準.
3. SEC A-A以"D"面為基準.

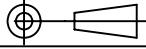
<b>JALINK</b> 展麒科技電子有限公司		A4 版		比例 SCALE	5/1	單位 UNIT	毫米 MM	客戶 CLIENT	
JALINK Technology INC.		版次 No. REV.		A3				產品編號 MODEL NO.	
核准 APPROVED	核對 CHECKED	設計 DESIGNED	制圖 DRAWN	材 質 MAT.	0.25t SUS301-3/4H (HV=370~420°)		產品名稱 PRODUCT NAME	鐵片式LOCK SATA 7P 高彈片	
		寧夢秋	寧夢秋	材料厚度 MAT. THICK	T=0.25mm		料 號 PRODUCT NO.	203-902650-000	
		05/08/18	05/08/18	表面處理 PRCS.			模具編號 MOULD NO.	JA265	

## Technical Data

SHINITE  
E202G30BK

FR/GF Grade / 防火 / 玻纖強化級 : DE3886

		Unit	Test Method	Values
<b>Mechanical properties</b>		<b>機械性質</b>		
Izod Impact(Notched)	衝擊強度	Kg-cm/cm	ASTM D256	8.4
Tensile Strength	拉伸強度	Kg/cm <sup>2</sup>	ASTM D638	1200
Elongation	拉伸率	%	ASTM D638	2.8
Flexural Strength	彎曲強度	Kg/cm <sup>2</sup>	ASTM D790	1870
Flexural Modulus	彎曲模數	Kg/cm <sup>2</sup>	ASTM D790	89700
Rockwell Hardness	洛式硬度	R	ASTM D785	120
<b>Thermal properties</b>		<b>熱性質</b>		
Heat Deflection Temperature	熱變形溫度		ASTM D648	
	66psi	°C		-
	264psi	°C		205
Flammability	防火性	-	UL94	V0
Melting Point	熔點	°C	DSC	223
<b>Electrical properties</b>		<b>電氣性質</b>		
Dielectric Strength	介電強度	KV/MM	ASTM D149	20
Dielectric Constant	介電常數	...	ASTM D150	4
Volume Resistivity	體積電阻	Ω -CM	ASTM D257	1.00E+16
<b>Other properties</b>		<b>其它性質</b>		
Specific Gravity	比重	-	ASTM D792	1.60
Water Absorption	吸水率	%	ASTM D570	0.07
Mold Shrinkage	成形收縮率		ASTM D955	
	Flow	%		0.2~0.4
	Cross Flow	%		0.5~0.9

UL file number : E107536

"Nothing in this information shall be construed as a recommendation for any use that may infringe on any patent right or as an endorsement of any material supplied by Shinkong Synthetic Fibers Corporation. We do not guarantee the applicability or the accuracy of this information or the performance of our products in any specific situation. We recommend each user of our products make its own tests to determine if the material is suitable for a particular use. The data show here are within the normal range of product properties, but they are NOT SPECIFICATION LIMITS. Additives of any kind alter some or all of the properties."

## Test Report

No. : CE/2014/94375

Date : 2014/09/25

Page: 1 of 5

SHINKONG SYNTHETIC FIBERS CORPORATION  
8F., NO. 123, SEC. 2, NANKING E. RD., TAIPEI, TAIWAN  
(SHINKONG INDUSTRY (HANGZHOU) CO., LTD)  
(NO.1, AVENUE 6, ECONOMY & TECHNOLOGY DEVELOPMENT ZONE, HANGZHOU, CHINA)



**The following sample(s) was/were submitted and identified by/on behalf of the applicant as :**

Sample Submitted By : SHINKONG SYNTHETIC FIBERS CORPORATION  
Sample Description : THERMOPLASTIC POLYESTER RESIN  
Style/Item No. : SHINITE® PBT E202G30BK  
Manufacturer/Vendor : SHINKONG SYNTHETIC FIBERS CORPORATION  
Country of Origin : TAIWAN  
Sample Receiving Date : 2014/09/19  
Testing Period : 2014/09/19 TO 2014/09/25

=====  
**Test Requested** : As specified by client, with reference to RoHS Directive 2011/65/EU Annex II to determine Cadmium, Lead, Mercury, Cr(VI), PBBs, PBDEs contents in the submitted sample.  
**Test Method** : Please refer to next page(s).  
**Test Result(s)** : Please refer to next page(s).

  
  
**Troy Chang, Manager - Tech**  
**Signed for and on behalf of**  
**SGS TAIWAN LTD.**  
**Chemical Laboratory - Taipei**

This document is issued by the Company subject to its General Conditions of Service printed overleaf, available on request or accessible at <http://www.sgs.com/en/Terms-and-Conditions.aspx> and, for electronic format documents, subject to Terms and Conditions for Electronic Documents at <http://www.sgs.com/en/Terms-and-Conditions/Termse-Document.aspx>. Attention is drawn to the limitation of liability, indemnification and jurisdiction issues defined therein. Any holder of this document is advised that information contained hereon reflects the Company's findings at the time of its intervention only and within the limits of client's instruction, if any. The Company's sole responsibility is to its Client and this document does not exonerate parties to a transaction from exercising all their rights and obligations under the transaction documents. This document cannot be reproduced, except in full, without prior written approval of the Company. Any unauthorized alteration, forgery or falsification of the content or appearance of this document is unlawful and offenders may be prosecuted to the fullest extent of the law. Unless otherwise stated the results shown in this test report refer only to the sample(s) tested.

# Test Report

No. : CE/2014/94375

Date : 2014/09/25

Page: 2 of 5

SHINKONG SYNTHETIC FIBERS CORPORATION  
 8F., NO. 123, SEC. 2, NANKING E. RD., TAIPEI, TAIWAN  
 (SHINKONG INDUSTRY (HANGZHOU) CO., LTD)  
 (NO.1, AVENUE 6, ECONOMY & TECHNOLOGY DEVELOPMENT ZONE, HANGZHOU, CHINA)



## Test Result(s)

PART NAME No.1 : BLACK PLASTIC PELLETS

Test Item(s)	Unit	Method	MDL	Result
				No.1
Cadmium (Cd)	mg/kg	With reference to IEC 62321-5: 2013 and performed by ICP-AES.	2	n.d.
Lead (Pb)	mg/kg	With reference to IEC 62321-5: 2013 and performed by ICP-AES.	2	11
Mercury (Hg)	mg/kg	With reference to IEC 62321-4: 2013 and performed by ICP-AES.	2	n.d.
Hexavalent Chromium Cr(VI)	mg/kg	With reference to IEC 62321: 2008 and performed by UV-VIS.	2	n.d.
<b>Sum of PBBs</b>	mg/kg	With reference to IEC 62321: 2008 and performed by GC/MS.	-	n.d.
Monobromobiphenyl	mg/kg		5	n.d.
Dibromobiphenyl	mg/kg		5	n.d.
Tribromobiphenyl	mg/kg		5	n.d.
Tetrabromobiphenyl	mg/kg		5	n.d.
Pentabromobiphenyl	mg/kg		5	n.d.
Hexabromobiphenyl	mg/kg		5	n.d.
Heptabromobiphenyl	mg/kg		5	n.d.
Octabromobiphenyl	mg/kg		5	n.d.
Nonabromobiphenyl	mg/kg		5	n.d.
Decabromobiphenyl	mg/kg		5	n.d.
<b>Sum of PBDEs</b>	mg/kg		-	n.d.
Monobromodiphenyl ether	mg/kg		5	n.d.
Dibromodiphenyl ether	mg/kg		5	n.d.
Tribromodiphenyl ether	mg/kg		5	n.d.
Tetrabromodiphenyl ether	mg/kg		5	n.d.
Pentabromodiphenyl ether	mg/kg		5	n.d.
Hexabromodiphenyl ether	mg/kg		5	n.d.
Heptabromodiphenyl ether	mg/kg		5	n.d.
Octabromodiphenyl ether	mg/kg		5	n.d.
Nonabromodiphenyl ether	mg/kg	5	n.d.	
Decabromodiphenyl ether	mg/kg	5	n.d.	

### Note :

1. mg/kg = ppm ; 0.1wt% = 1000ppm
2. n.d. = Not Detected
3. MDL = Method Detection Limit
4. " - " = Not Regulated

This document is issued by the Company subject to its General Conditions of Service printed overleaf, available on request or accessible at <http://www.sgs.com/en/Terms-and-Conditions.aspx> and, for electronic format documents, subject to Terms and Conditions for Electronic Documents at <http://www.sgs.com/en/Terms-and-Conditions/Termse-Documents.aspx>. Attention is drawn to the limitation of liability, indemnification and jurisdiction issues defined therein. Any holder of this document is advised that information contained hereon reflects the Company's findings at the time of its intervention only and within the limits of client's instruction, if any. The Company's sole responsibility is to its Client and this document does not exonerate parties to a transaction from exercising all their rights and obligations under the transaction documents. This document cannot be reproduced, except in full, without prior written approval of the Company. Any unauthorized alteration, forgery or falsification of the content or appearance of this document is unlawful and offenders may be prosecuted to the fullest extent of the law. Unless otherwise stated the results shown in this test report refer only to the sample(s) tested.

SHINKONG SYNTHETIC FIBERS CORPORATION  
 8F., NO. 123, SEC. 2, NANKING E. RD., TAIPEI, TAIWAN  
 (SHINKONG INDUSTRY (HANGZHOU) CO., LTD)  
 (NO.1, AVENUE 6, ECONOMY & TECHNOLOGY DEVELOPMENT ZONE, HANGZHOU, CHINA)



- 1) These samples were dissolved totally by pre-conditioning method according to below flow chart.  
 (Cr<sup>6+</sup> test method excluded)
- 2) Name of the person who made measurement: Climbgreat Yang
- 3) Name of the person in charge of measurement: Troy Chang

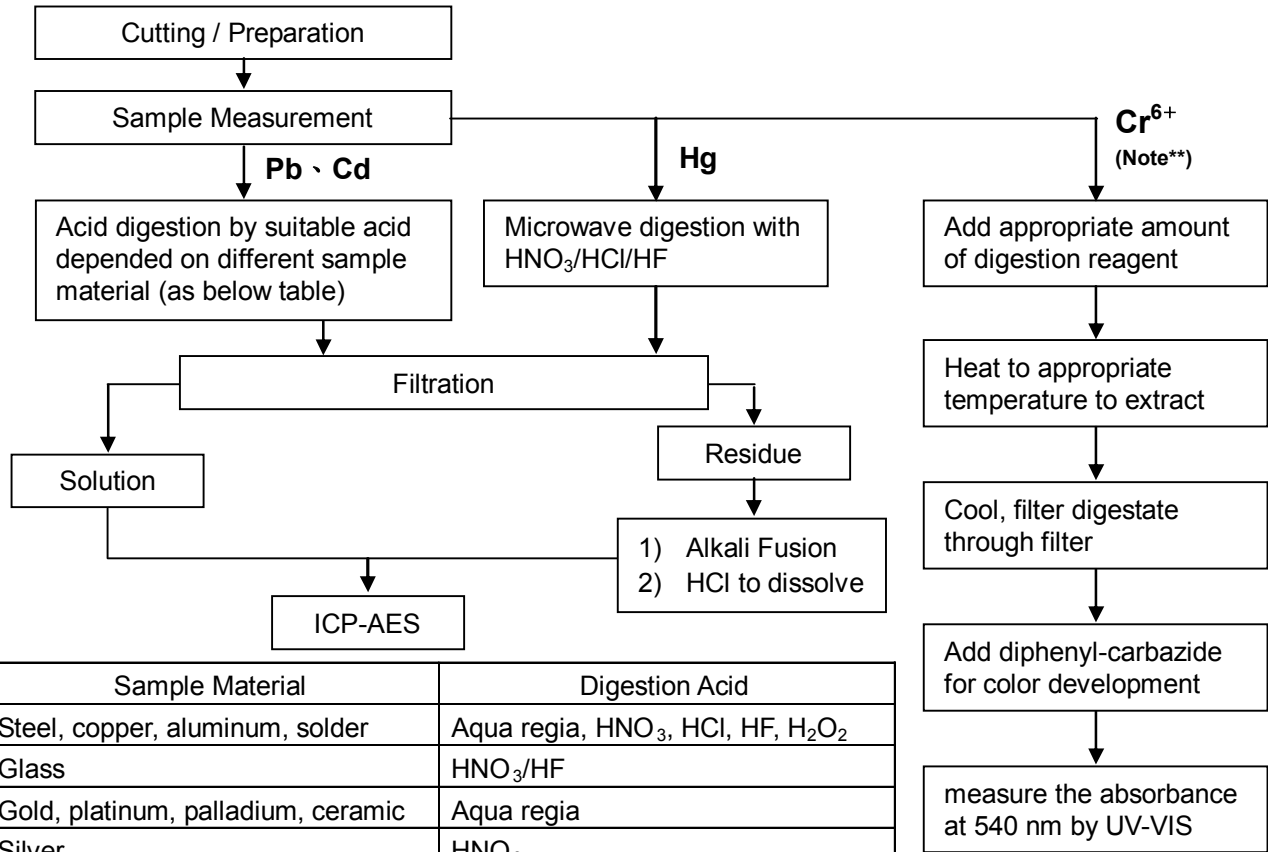

Sample Material	Digestion Acid
Steel, copper, aluminum, solder	Aqua regia, HNO <sub>3</sub> , HCl, HF, H <sub>2</sub> O <sub>2</sub>
Glass	HNO <sub>3</sub> /HF
Gold, platinum, palladium, ceramic	Aqua regia
Silver	HNO <sub>3</sub>
Plastic	H <sub>2</sub> SO <sub>4</sub> , H <sub>2</sub> O <sub>2</sub> , HNO <sub>3</sub> , HCl
Others	Added appropriate reagent to total digestion

**Note\*\* :** (1) For non-metallic material, add alkaline digestion reagent and heat to 90~95 °C.  
 (2) For metallic material, add pure water and heat to boiling.

This document is issued by the Company subject to its General Conditions of Service printed overleaf, available on request or accessible at <http://www.sgs.com/en/Terms-and-Conditions.aspx> and, for electronic format documents, subject to Terms and Conditions for Electronic Documents at <http://www.sgs.com/en/Terms-and-Conditions/Termse-Document.aspx>. Attention is drawn to the limitation of liability, indemnification and jurisdiction issues defined therein. Any holder of this document is advised that information contained hereon reflects the Company's findings at the time of its intervention only and within the limits of client's instruction, if any. The Company's sole responsibility is to its Client and this document does not exonerate parties to a transaction from exercising all their rights and obligations under the transaction documents. This document cannot be reproduced, except in full, without prior written approval of the Company. Any unauthorized alteration, forgery or falsification of the content or appearance of this document is unlawful and offenders may be prosecuted to the fullest extent of the law. Unless otherwise stated the results shown in this test report refer only to the sample(s) tested.



SHINKONG SYNTHETIC FIBERS CORPORATION  
 8F., NO. 123, SEC. 2, NANKING E. RD., TAIPEI, TAIWAN  
 (SHINKONG INDUSTRY (HANGZHOU) CO., LTD)  
 (NO.1, AVENUE 6, ECONOMY & TECHNOLOGY DEVELOPMENT ZONE, HANGZHOU, CHINA)



### PBB/PBDE analytical FLOW CHART

- Name of the person who made measurement: Roman Wong
- Name of the person in charge of measurement: Troy Chang

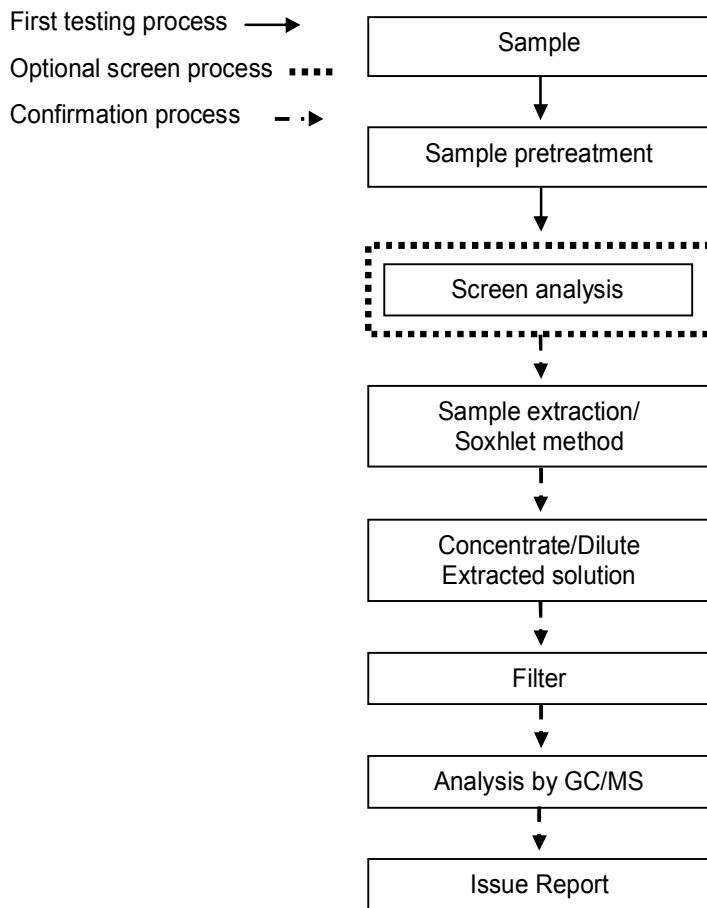

This document is issued by the Company subject to its General Conditions of Service printed overleaf, available on request or accessible at <http://www.sgs.com/en/Terms-and-Conditions.aspx> and, for electronic format documents, subject to Terms and Conditions for Electronic Documents at <http://www.sgs.com/en/Terms-and-Conditions/Termse-Document.aspx>. Attention is drawn to the limitation of liability, indemnification and jurisdiction issues defined therein. Any holder of this document is advised that information contained hereon reflects the Company's findings at the time of its intervention only and within the limits of client's instruction, if any. The Company's sole responsibility is to its Client and this document does not exonerate parties to a transaction from exercising all their rights and obligations under the transaction documents. This document cannot be reproduced, except in full, without prior written approval of the Company. Any unauthorized alteration, forgery or falsification of the content or appearance of this document is unlawful and offenders may be prosecuted to the fullest extent of the law. Unless otherwise stated the results shown in this test report refer only to the sample(s) tested.

## Test Report

No. : CE/2014/94375

Date : 2014/09/25

Page: 5 of 5

SHINKONG SYNTHETIC FIBERS CORPORATION  
8F., NO. 123, SEC. 2, NANKING E. RD., TAIPEI, TAIWAN  
(SHINKONG INDUSTRY (HANGZHOU) CO., LTD)  
(NO.1, AVENUE 6, ECONOMY & TECHNOLOGY DEVELOPMENT ZONE, HANGZHOU, CHINA)



\* The tested sample / part is marked by an arrow if it's shown on the photo. \*

## CE/2014/94375



\*\* End of Report \*\*

This document is issued by the Company subject to its General Conditions of Service printed overleaf, available on request or accessible at <http://www.sgs.com/en/Terms-and-Conditions.aspx> and, for electronic format documents, subject to Terms and Conditions for Electronic Documents at <http://www.sgs.com/en/Terms-and-Conditions/Termse-Documents.aspx>. Attention is drawn to the limitation of liability, indemnification and jurisdiction issues defined therein. Any holder of this document is advised that information contained hereon reflects the Company's findings at the time of its intervention only and within the limits of client's instruction, if any. The Company's sole responsibility is to its Client and this document does not exonerate parties to a transaction from exercising all their rights and obligations under the transaction documents. This document cannot be reproduced, except in full, without prior written approval of the Company. Any unauthorized alteration, forgery or falsification of the content or appearance of this document is unlawful and offenders may be prosecuted to the fullest extent of the law. Unless otherwise stated the results shown in this test report refer only to the sample(s) tested.



**Test Report** No. F690101/LF-CTSAYAA14-34559

Issued Date : 2014. 07. 21

Page 1 of 6

LEE KU INDUSTRIALS CO.,LTD.  
42,Poseunggongdan-ro Poseung-eup  
Pyeongtak-si,Gyeonggi-do  
Korea

The following sample(s) was/were submitted and identified by/on behalf of the client as:-

SGS File No. : AYAA14-34559  
Product Name : C5191(Phosphor Bronze Sn6%)  
Item No./Part No. : N/A  
Buyer(s) : KAI KEE METAL, SAMSUNG  
Received Date : 2014. 07. 14  
Test Period : 2014. 07. 15 to 2014. 07. 21  
Test Results : For further details, please refer to following page(s)

SGS Korea Co., Ltd.

Jeff Jang / Chemical Lab MR



This document is issued by the Company subject to its General Conditions of Service printed overleaf, available on request or accessible at <http://www.sgs.com/en/Terms-and-Conditions.aspx> and, for electronic format documents, subject to Terms and Conditions for Electronic Documents at [www.sgs.com/terms\\_e-document.htm](http://www.sgs.com/terms_e-document.htm) <[http://www.sgs.com/terms\\_e-document.htm](http://www.sgs.com/terms_e-document.htm)>. Attention is drawn to the limitation of liability, indemnification and jurisdiction issues defined therein. Any holder of this document is advised that information contained hereon reflects the Company's findings at the time of its intervention only and within the limits of Client's instructions, if any. The Company's sole responsibility is to its Client and this document does not exonerate parties to a transaction from exercising all their rights and obligations under the transaction documents. This document cannot be reproduced except in full, without prior written approval of the Company. Any unauthorized alteration, forgery or falsification of the content or appearance of this document is unlawful and offenders may be prosecuted to the fullest extent of the law. Unless otherwise stated the results shown in this test report refer only to the sample(s).

SGS Korea Co.Ltd.

322, The Ovalley, E. LS-ro, Dangan-gu, Anyang-si, Gyeonggi-do, Korea 431-080  
T+82 (0)31 408 090 F+82 (0)31 406 058 <http://www.sgsgroup.kr>





# Test Report No. F690101/LF-CTSAYAA14-34559

Issued Date : 2014. 07. 21

Page 2 of 6

Sample No. : AYAA14-34559.001  
 Sample Description : C5191(Phosphor Bronze Sr6%)  
 Item No./Part No. : N/A  
 Materials : N/A

## Heavy Metals

Test Items	Unit	Test Method	MDL	Results
Cadmium (Cd)	mg/kg	With reference to IEC62321-5:2013 (Determination of Cadmium by ICP-OES)	0.5	N.D.
Lead (Pb)	mg/kg	With reference to IEC62321-5:2013 (Determination of Lead by CP-OES)	5	43.2
Mercury (Hg)	mg/kg	With reference to IEC62321-4:2013 (Determination of Mercury by ICP-OES)	2	N.D.
Hexavalent Chromium (Cr VI) By boiling water extraction*	**	With reference to IEC62321:2008 (Determination of Hexavalent Chromium by spot test/Colorimetric Method using UV-Vis)	-	Negative
Beryllium (Be)	mg/kg	With reference to EA 3052(1996), US EPA 6010B(1996), ICP	0.5	N.D.

## Flame Retardants-PBBs/PBDEs

Test Items	Unit	Test Method	MDL	Results
Monobromobiphenyl	mg/kg	With reference to IEC62321:2008 (Determination of PBBs and PBDEs by GC-MS)	5	N.D.
Dibromobiphenyl	mg/kg	With reference to IEC62321:2008 (Determination of PBBs and PBDEs by GC-MS)	5	N.D.
Tribromobiphenyl	mg/kg	With reference to IEC62321:2008 (Determination of PBBs and PBDEs by GC-MS)	5	N.D.
Tetrabromobiphenyl	mg/kg	With reference to IEC62321:2008 (Determination of PBBs and PBDEs by GC-MS)	5	N.D.
Pentabromobiphenyl	mg/kg	With reference to IEC62321:2008 (Determination of PBBs and PBDEs by GC-MS)	5	N.D.
Hexabromobiphenyl	mg/kg	With reference to IEC62321:2008 (Determination of PBBs and PBDEs by GC-MS)	5	N.D.
Heptabromobiphenyl	mg/kg	With reference to IEC62321:2008 (Determination of PBBs and PBDEs by GC-MS)	5	N.D.
Octabromobiphenyl	mg/kg	With reference to IEC62321:2008 (Determination of PBBs and PBDEs by GC-MS)	5	N.D.
Nonabromobiphenyl	mg/kg	With reference to IEC62321:2008 (Determination of PBBs and PBDEs by GC-MS)	5	N.D.
Decabromobiphenyl	mg/kg	With reference to IEC62321:2008 (Determination of PBBs and PBDEs by GC-MS)	5	N.D.
Monobromodiphenyl ether	mg/kg	With reference to IEC62321:2008 (Determination of PBBs and PBDEs by GC-MS)	5	N.D.
Dibromodiphenyl ether	mg/kg	With reference to IEC62321:2008 (Determination of PBBs and PBDEs by GC-MS)	5	N.D.
Tribromodiphenyl ether	mg/kg	With reference to IEC62321:2008 (Determination of PBBs and PBDEs by GC-MS)	5	N.D.

This document is issued by the Company subject to its General Conditions of Service printed overleaf, available on request or accessible at <http://www.sgs.com/en/Terms-and-Conditions.aspx> and, for electronic format documents, subject to Terms and Conditions for Electronic Documents at [www.sgs.com/terms-e-document.htm](http://www.sgs.com/terms-e-document.htm) <http://www.sgs.com/terms-e-document.htm>. Attention is drawn to the limitation of liability, indemnification and jurisdiction issues defined therein. Any holder of this document is advised that information contained herein reflects the Company's findings at the time of its intervention only and within the limits of Client's instructions, if any. The Company's sole responsibility is to its Client and this document does not exonerate parties to a transaction from exercising all their rights and obligations under the transaction documents. This document cannot be reproduced except in full, without prior written approval of the Company. Any unauthorized alteration, forgery or falsification of the content or appearance of this document is unlawful and offenders may be prosecuted to the fullest extent of the law. Unless otherwise stated the results shown in this test report refer only to the sample(s).





# Test Report No. F690101/LF-CTSAYAA14-34559

Issued Date : 2014. 07. 21

Page 3 of 6

Sample No. : AYAA14-34559.001  
 Sample Description : C5191(Phosphor Bronze Sn6%)  
 Item No./Part No. : N/A  
 Materials : N/A

## Flame Retardants-PBBs/PBDEs

Test Items	Unit	Test Method	MDL	Results
Tetrabromodiphenyl ether	mg/kg	With reference to IEC62321:2008 (Determination of PBBs and PBDEs by GC-MS)	5	N.D.
Pentabromodiphenyl ether	mg/kg	With reference to IEC62321:2008 (Determination of PBBs and PBDEs by GC-MS)	5	N.D.
Hexabromodiphenyl ether	mg/kg	With reference to IEC62321:2008 (Determination of PBBs and PBDEs by GC-MS)	5	N.D.
Heptabromodiphenyl ether	mg/kg	With reference to IEC62321:2008 (Determination of PBBs and PBDEs by GC-MS)	5	N.D.
Octabromodiphenyl ether	mg/kg	With reference to IEC62321:2008 (Determination of PBBs and PBDEs by GC-MS)	5	N.D.
Nonabromodiphenyl ether	mg/kg	With reference to IEC62321:2008 (Determination of PBBs and PBDEs by GC-MS)	5	N.D.
Decabromodiphenyl ether	mg/kg	With reference to IEC62321:2008 (Determination of PBBs and PBDEs by GC-MS)	5	N.D.

- NOTE:
- (1) N.D. = Not detected. (<MDL)
  - (2) mg/kg = ppm
  - (3) MDL = Method Detection Limit
  - (4) - = Noregulation
  - (5) Negative = Undetectable / Positive = Detectable
  - (6) \*\* = Qualitative analysis (No Unit)
  - (7) \* = Boiling-water-extraction:  
 Negative = Absence of CrVI coating  
 Positive = Presence of CrVI coating; the detected concentration in boiling-water-extraction solution is equal or greater than 0.02 mg/kg with 5 cm<sup>2</sup> sample surface area.



This document is issued by the Company subject to its General Conditions of Service printed overleaf, available on request or accessible at <http://www.sgs.com/en/Terms-and-Conditions.aspx> and, for electronic format documents, subject to Terms and Conditions for Electronic Documents at [www.sgs.com/terms\\_e-document.htm](http://www.sgs.com/terms_e-document.htm) <[http://www.sgs.com/terms\\_e-document.htm](http://www.sgs.com/terms_e-document.htm)>. Attention is drawn to the limitation of liability, indemnification and jurisdiction issues defined therein. Any holder of this document is advised that information contained hereon reflects the Company's findings at the time of its intervention only and within the limits of Client's instructions, if any. The Company's sole responsibility is to its Client and this document does not exonerate parties to a transaction from exercising all their rights and obligations under the transaction documents. This document cannot be reproduced except in full, without prior written approval of the Company. Any unauthorized alteration, forgery or falsification of the content or appearance of this document is unlawful and offenders may be prosecuted to the fullest extent of the law. Unless otherwise stated the results shown in this test report refer only to the sample(s).



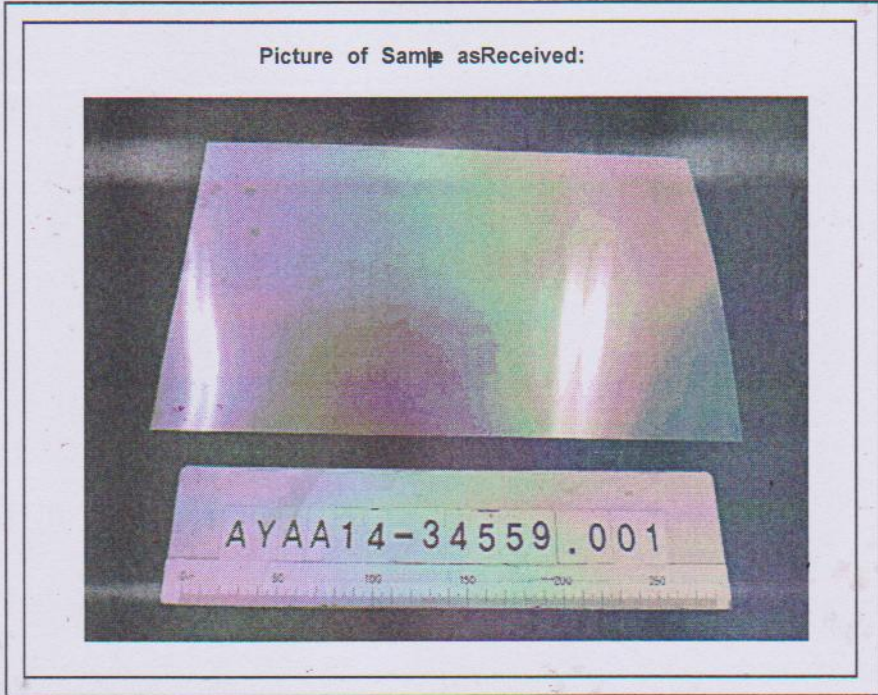

This document is issued by the Company subject to its General Conditions of Service printed overleaf, available on request or accessible at <http://www.sgs.com/en/Terms-and-Conditions.aspx> and, for electronic format documents, subject to Terms and Conditions for Electronic Documents at [www.sgs.com/terms\\_e-document.htm](http://www.sgs.com/terms_e-document.htm) [http://www.sgs.com/terms\\_e-document.htm](http://www.sgs.com/terms_e-document.htm). Attention is drawn to the limitation of liability, indemnification and jurisdiction issues defined therein. Any holder of this document is advised that information contained hereon reflects the Company's findings at the time of its intervention only and within the limits of Client's instructions, if any. The Company's sole responsibility is to its Client and this document does not exonerate parties to a transaction from exercising all their rights and obligations under the transaction documents. This document cannot be reproduced except in full, without prior written approval of the Company. Any unauthorized alteration, forgery or falsification of the content or appearance of this document is unlawful and offenders may be prosecuted to the fullest extent of the law. Unless otherwise stated the results shown in the test report refer only to the sample(s).



Testing Flow Chart for RoHS: Cd/Pb/Hg/Cr<sup>6+</sup> /PBBs&PBDEs Testing

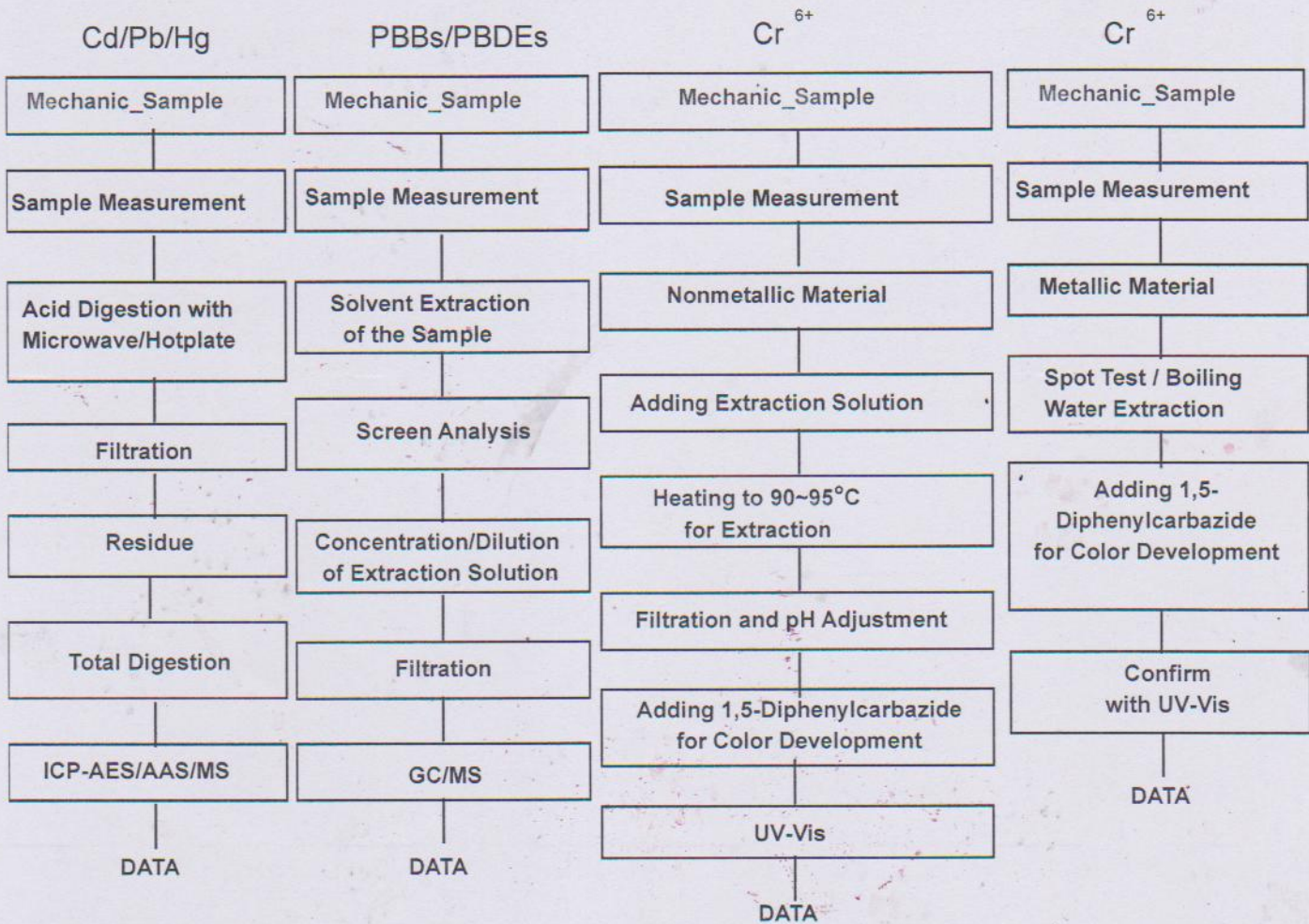

The samples were dissolved totally by pre-conditioning method according to above flowchart for Cd,Pb,Hg.  
 Chen Chaf Gilsae Yi



This document is issued by the Company subject to its General Conditions of Service printed overleaf, available on request or accessible at <http://www.sgs.com/en/Terms-and-Conditions.aspx> and, for electronic format documents, subject to Terms and Conditions for Electronic Documents at [www.sgs.com/terms\\_e-document.htm](http://www.sgs.com/terms_e-document.htm) <[http://www.sgs.com/terms\\_e-document.htm](http://www.sgs.com/terms_e-document.htm)>. Attention is drawn to the limitation of liability, indemnification and jurisdiction issues defined therein. Any holder of this document is advised that information contained hereon reflects the Company's findings at the time of its intervention only and within the limits of Client's instructions, if any. The Company's sole responsibility is to its Client and this document does not exonerate parties to a transaction from exercising all their rights and obligations under the transaction documents. This document cannot be reproduced except in full, without prior written approval of the Company. Any unauthorized alteration, forgery or falsification of the content or appearance of this document is unlawful and offenders may be prosecuted to the fullest extent of the law. Unless otherwise stated the results shown in the test report refer only to the sample(s).





### Flow Chart for Inorganic Elements Testing

#### Inorganic Elements

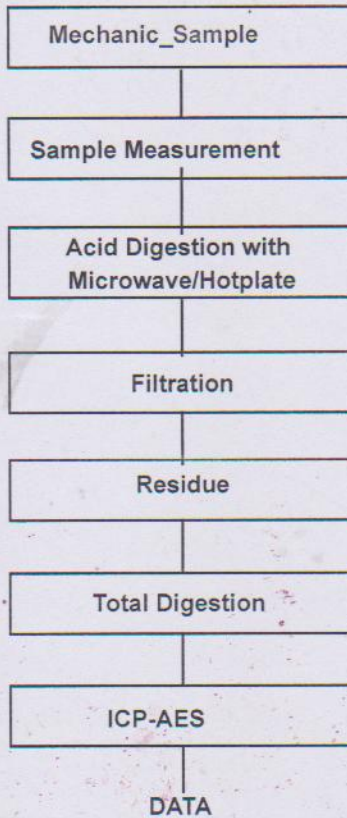

Major Inorganic Heavy Metals	Antimony(Sb) ,Beryllium(Be) , Phosphorus(P) , Arsenic(As) etc.
---------------------------------	---

\*\*\* End of Report \*\*\*



This document is issued by the Company subject to its General Conditions of Service printed overleaf, available on request or accessible at <http://www.sgs.com/en/Terms-and-Conditions.aspx> and, for electronic format documents, subject to Terms and Conditions for Electronic Documents at [www.sgs.com/terms\\_e-document.htm](http://www.sgs.com/terms_e-document.htm) <[http://www.sgs.com/terms\\_e-document.htm](http://www.sgs.com/terms_e-document.htm)>. Attention is drawn to the limitation of liability, indemnification and jurisdiction issues defined therein. Any holder of this document is advised that information contained hereon reflects the Company's findings at the time of its intervention only and within the limits of Client's instructions, if any. The Company's sole responsibility is to its Client and this document does not exonerate parties to a transaction from exercising all their rights and obligations under the transaction documents. This document cannot be reproduced except in full, without prior written approval of the Company. Any unauthorized alteration, forgery or falsification of the content or appearance of this document is unlawful and offenders may be prosecuted to the fullest extent of the law. Unless otherwise stated the results shown in this test report refer only to the sample(s).



## Test Report

No. CANEC1506413211

Date: 29 Apr 2015

Page 1 of 4

SHENZHEN JUTENG METAL MATERIAL CO.,LTD

BUILDING 2 HUAFENG OVERSEAS STUDENTS PIONEER PARK BAOLONG FIRST ROAD NANYUE  
LONGGANG DISTRICT SHENZHEN CITY



The following sample(s) was/were submitted and identified on behalf of the clients as : SUS301

SGS Job No. : CP15-021918 - SZ

Date of Sample Received : 24 Apr 2015

Testing Period : 24 Apr 2015 - 28 Apr 2015

Test Requested : Selected test(s) as requested by client.

Test Method : Please refer to next page(s).

Test Results : Please refer to next page(s).

Conclusion : Based on the performed tests on submitted sample(s), the results of Lead, Mercury, Cadmium, Hexavalent chromium comply with the limits as set by RoHS Directive 2011/65/EU Annex II; recasting 2002/95/EC.

Signed for and on behalf of  
SGS-CSTC Standards Technical Services Co., Ltd. Guangzhou Branch

*Merry*

Merry Lv  
Approved Signatory



This document is issued by the Company subject to its General Conditions of Service printed overleaf, available on request or accessible at <http://www.sgs.com/en/Terms-and-Conditions.aspx> and, for electronic format documents, subject to Terms and Conditions for Electronic Documents at <http://www.sgs.com/en/Terms-and-Conditions/Terms-e-Document.aspx>. Attention is drawn to the limitation of liability, indemnification and jurisdiction issues defined therein. Any holder of this document is advised that information contained hereon reflects the Company's findings at the time of its intervention only and within the limits of Client's instructions, if any. The Company's sole responsibility is to its Client and this document does not exonerate parties to a transaction from exercising all their rights and obligations under the transaction documents. This document cannot be reproduced except in full, without prior written approval of the Company. Any unauthorized alteration, forgery or falsification of the content or appearance of this document is unlawful and offenders may be prosecuted to the fullest extent of the law. Unless otherwise stated the results shown in this test report refer only to the sample(s) tested.

Attention: To check the authenticity of testing /inspection report & certificate, please contact us at telephone: (86-755)8367 1443, or email: [CN.Doccheck@sgs.com](mailto:CN.Doccheck@sgs.com)

SGS-CSTC Standards Technical Services Co., Ltd.  
Guangzhou Standards Technical Laboratory

198 Kazhu Road, Saientech Park Guangzhou Economic & Technology Development District, Guangzhou, China 510663 t (86-20) 82155555 f (86-20) 82075113 www.sgs.com.cn  
中国·广州·经济技术开发区科学城科珠路198号 邮编: 510663 t (86-20) 82155555 f (86-20) 82075113 e [sgs.china@sgs.com](mailto:sgs.china@sgs.com)

Member of the SGS Group (SGS SA)



## Test Report

No. CANEC1506413211

Date: 29 Apr 2015

Page 2 of 4

Test Results :

### Test Part Description :

Specimen No.	SGS Sample ID	Description
SN1	CAN15-064132.005	Silver-gray metal

Remarks :

- (1) 1 mg/kg = 1 ppm = 0.0001%
- (2) MDL = Method Detection Limit
- (3) ND = Not Detected ( < MDL )
- (4) "-" = Not Regulated

### RoHS Directive 2011/65/EU

Test Method : (1)With reference to IEC 62321-5:2013, determination of Cadmium by ICP-OES.  
 (2)With reference to IEC 62321-5:2013, determination of Lead by ICP-OES.  
 (3)With reference to IEC 62321-4:2013, determination of Mercury by ICP-OES.  
 (4)With reference to IEC 62321:2008, determination of Hexavalent Chromium by spot test / Colorimetric Method using UV-Vis.

Test Item(s)	Limit	Unit	MDL	005
Cadmium (Cd)	100	mg/kg	2	ND
Lead (Pb)	1,000	mg/kg	2	ND
Mercury (Hg)	1,000	mg/kg	2	ND
Hexavalent Chromium (CrVI)	-	-	◇	Negative

Notes :

- (1) The maximum permissible limit is quoted from the directive 2011/65/EU, Annex II.
  - (2)◇Spot-test:  
 Negative = Absence of CrVI coating, Positive = Presence of CrVI coating;  
 (The tested sample should be further verified by boiling-water-extraction method if the spot test result is Negative or cannot be confirmed.)
  - ◇Boiling-water-extraction:  
 Negative = Absence of CrVI coating  
 Positive = Presence of CrVI coating; the detected concentration in boiling-water-extraction solution is equal or greater than 0.02 mg/kg with 50 cm2 sample surface area.
- Information on storage conditions and production date of the tested sample is unavailable and thus result of Cr(VI) represent status of the sample at the time of testing.



This document is issued by the Company subject to its General Conditions of Service printed overleaf, available on request or accessible at <http://www.sgs.com/en/terms-and-conditions.aspx> and, for electronic format documents, subject to Terms and Conditions for Electronic Documents at <http://www.sgs.com/en/terms-and-conditions/terms-e-document.aspx>. Attention is drawn to the limitation of liability, indemnification and jurisdiction issues defined therein. Any holder of this document is advised that information contained hereon reflects the Company's findings at the time of its intervention only and within the limits of Client's instructions, if any. The Company's sole responsibility is to its Client and this document does not exonerate parties to a transaction from exercising all their rights and obligations under the transaction documents. This document cannot be reproduced except in full, without prior written approval of the Company. Any unauthorized alteration, forgery or falsification of the content or appearance of this document is unlawful and offenders may be prosecuted to the fullest extent of the law. Unless otherwise stated the results shown in this test report refer only to the sample(s) tested.

Attention: To check the authenticity of testing / inspection report & certificate, please contact us at telephone: (86-759) 8307 1443, or email: CN.Doccheck@sgs.com

SGS Standards Technical Services Co., Ltd.  
 Guangzhou Standards Technical Laboratory

198 Kezhu Road, Science Park Guangzhou Economic & Technology Development District, Guangzhou, China 510663 t (86-20) 82155555 f (86-20) 82075113 www.sgs.com.cn  
 中国·广州·经济技术开发区科学城科珠路198号 邮编: 510663 t (86-20) 82155555 f (86-20) 82075113 e sgs.china@sgs.com

## ATTACHMENTS

### RoHS Testing Flow Chart

- 1) Name of the person who made testing: Bruce Xiao
- 2) Name of the person in charge of testing: Bella Wang
- 3) These samples were dissolved totally by pre-conditioning method according to below flow chart (Cr6+ test method excluded).

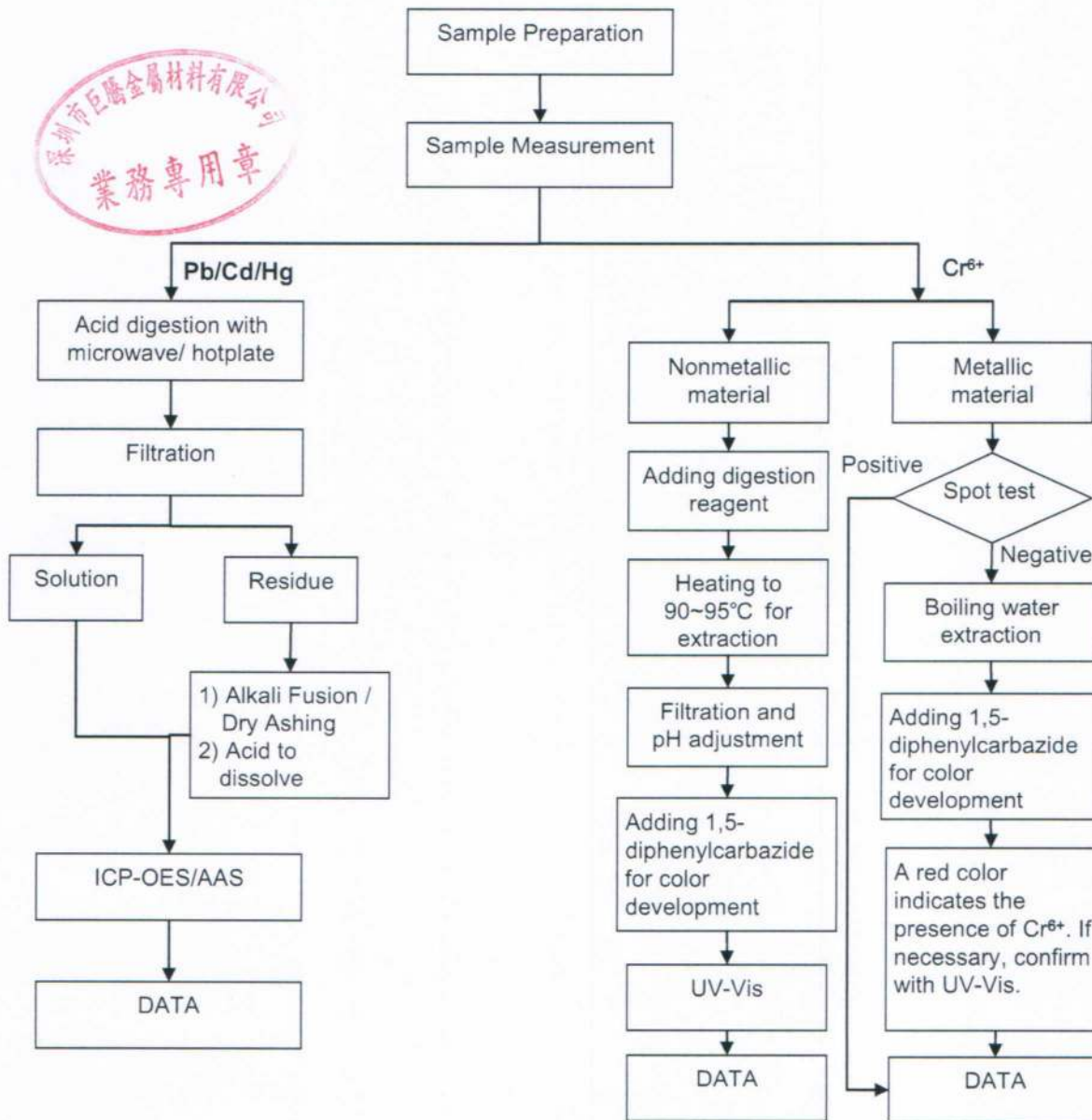

This document is issued by the Company subject to its General Conditions of Service printed overleaf, available on request or accessible at <http://www.sgs.com/en/terms-and-conditions.aspx> and, for electronic format documents, subject to Terms and Conditions for Electronic Documents at <http://www.sgs.com/en/terms-and-conditions/terms-e-document.aspx>. Attention is drawn to the limitation of liability, indemnification and jurisdiction issues defined therein. Any holder of this document is advised that information contained hereon reflects the Company's findings at the time of its intervention only and within the limits of Client's instructions, if any. The Company's sole responsibility is to its Client and this document does not exonerate parties to a transaction from exercising all their rights and obligations under the transaction documents. This document cannot be reproduced except in full, without prior written approval of the Company. Any unauthorized alteration, forgery or falsification of the content or appearance of this document is unlawful and offenders may be prosecuted to the fullest extent of the law. Unless otherwise stated the results shown in this test report refer only to the sample(s) tested. Attention: To check the authenticity of testing / inspection report & certificate, please contact us at telephone: (86-755) 8307 1443, or email: CN\_Doccheck@sgs.com.



Sample photo:

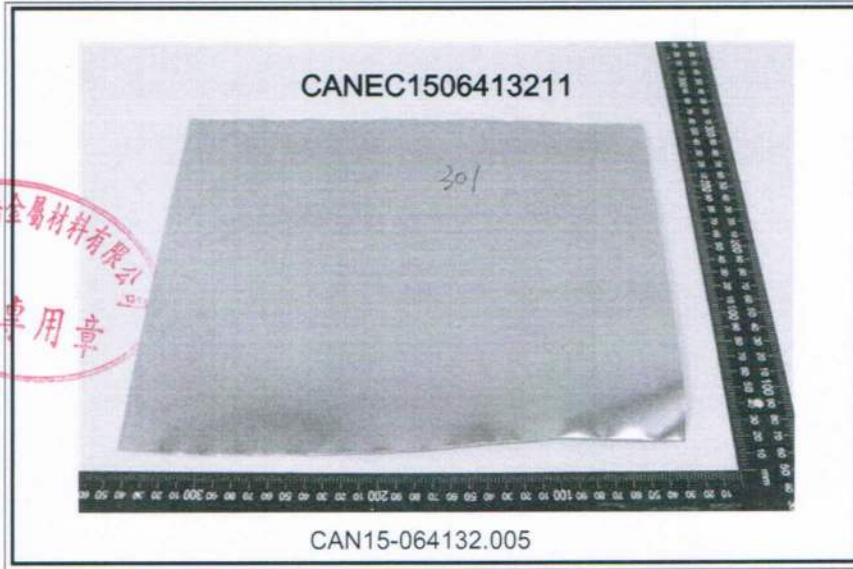

SGS authenticate the photo on original report only

\*\*\* End of Report \*\*\*



This document is issued by the Company subject to its General Conditions of Service printed overleaf, available on request or accessible at <http://www.sgs.com/en/terms-and-conditions.aspx> and, for electronic format documents, subject to Terms and Conditions for Electronic Documents at <http://www.sgs.com/en/terms-and-conditions/terms-e-document.aspx>. Attention is drawn to the limitation of liability, indemnification and jurisdiction issues defined therein. Any holder of this document is advised that information contained hereon reflects the Company's findings at the time of its intervention only and within the limits of Client's instructions, if any. The Company's sole responsibility is to its Client and this document does not exonerate parties to a transaction from exercising all their rights and obligations under the transaction documents. This document cannot be reproduced except in full, without prior written approval of the Company. Any unauthorized alteration, forgery or falsification of the content or appearance of this document is unlawful and offenders may be prosecuted to the fullest extent of the law. Unless otherwise stated the results shown in this test report refer only to the sample(s) tested.

Attention: To check the authenticity of testing/inspection report & certificate, please contact us at telephone: (86-755) 8307 1443, or email: [CN.Doccheck@sgs.com](mailto:CN.Doccheck@sgs.com)



4

3

2

1

PART NO.

REVISIONS			
LTR	DESCRIPTION	DATE	APPROVED
A	Initial Release for Manufacture		

# 新模具图

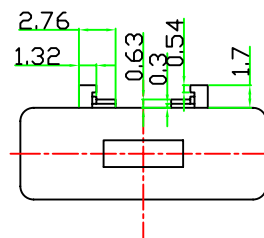
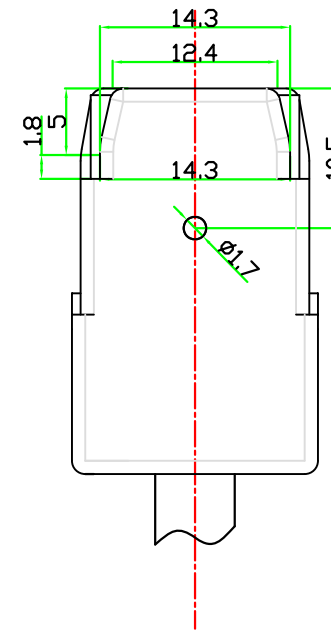
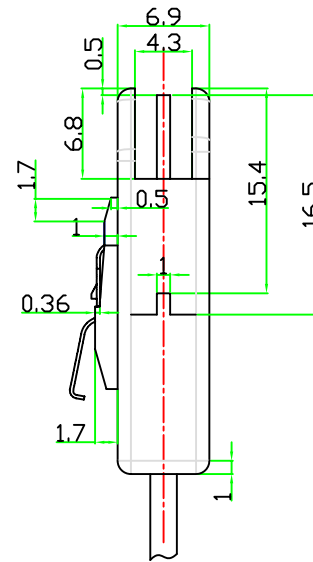
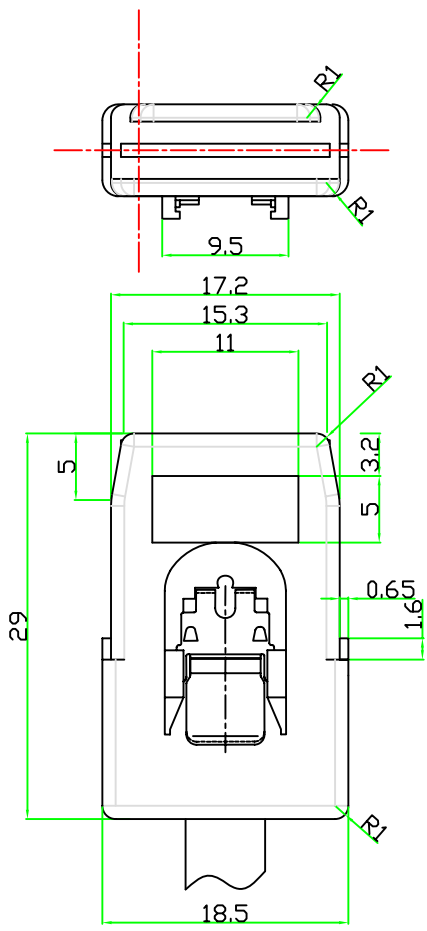
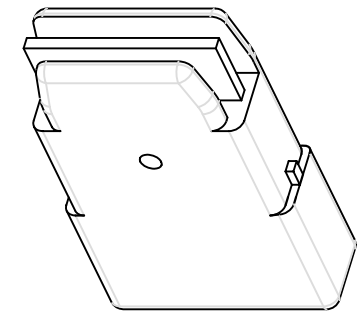

DIMENSION ARE MILLIMETERS TOLERANCES ARE :  DECIMALS ANGLES .X $\pm 0.30$ $\pm 0.3^\circ$ .XX $\pm 0.20$  DIMENSION IN BRACKET [X.XX] ARE INCHES TOLERANCES ARE :  DECIMALS ANGLES .XX $\pm 0$ $\pm 0$ .XXX $\pm 0$  DO NOT SCALE DRAWING	APPROVALS	DATE		
	DRAWN			
	INSPECTED		<b>MINI SAS36P</b>	
	CHECKED			
	SIZE C SCALE : XX : XX FORM NO.	DRAWING NO.	REV. A	SHEET 1 OF 1

4

3

2

1

D

C

B

A

D

C

B

A

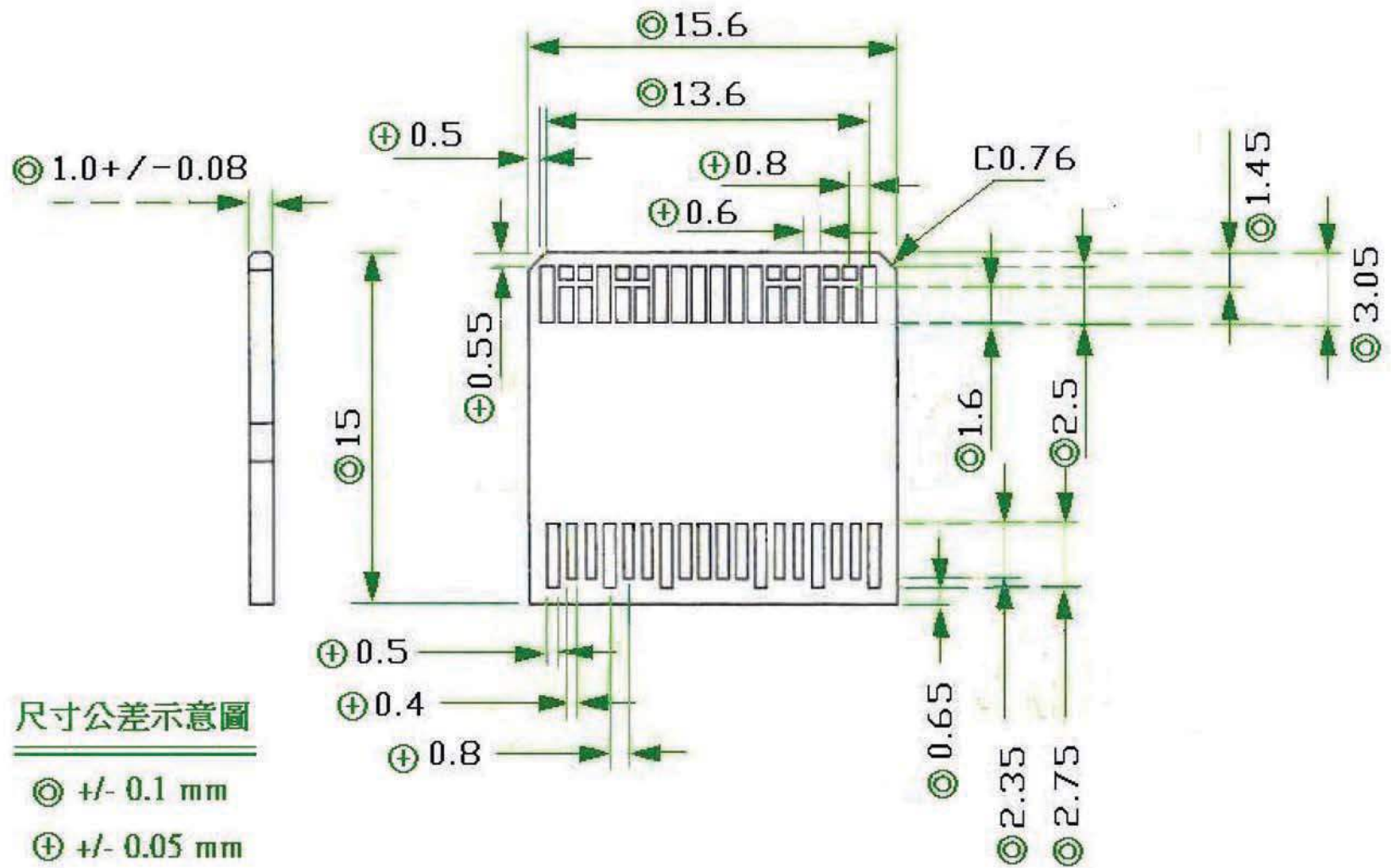

## 測試報告

## Test Report

號碼(No.) : CE/2014/42639 日期(Date) : 2014/04/17 頁數(Page) : 1 of 11

鴻海精密工業股份有限公司

HON HAI PRECISION IND. CO., LTD.

新北市土城區自由街2號

NO. 2, ZIHYOU ST., TUCHENG DIST., NEW TAIPEI CITY 23678, TAIWAN (R. O. C.)



以下測試樣品係由申請廠商所提供及確認 (The following sample(s) was/were submitted and identified by/on behalf of the applicant as) :

樣品名稱(Sample Description) : POTASSIUM GOLD CYANIDE (金氰化鉀)  
樣品型號(Style/Item No.) : 903-0000-020  
收件日期(Sample Receiving Date) : 2014/04/11  
測試期間(Testing Period) : 2014/04/11 TO 2014/04/17

測試結果(Test Results) : 請見下一頁 (Please refer to next pages).

  
  
Troy Chang / Manager - Tech  
Signed for and on behalf of  
SGS TAIWAN LTD.  
Chemical Laboratory - Taipei

This document is issued by the Company subject to its General Conditions of Service printed overleaf, available on request or accessible at <http://www.sgs.com/en/Terms-and-Conditions.aspx> and, for electronic format documents, subject to Terms and Conditions for Electronic Documents at <http://www.sgs.com/en/Terms-and-Conditions/Termse-Document.aspx>. Attention is drawn to the limitation of liability, indemnification and jurisdiction issues defined therein. Any holder of this document is advised that information contained hereon reflects the Company's findings at the time of its intervention only and within the limits of client's instruction, if any. The Company's sole responsibility is to its Client and this document does not exonerate parties to a transaction from exercising all their rights and obligations under the transaction documents. This document cannot be reproduced, except in full, without prior written approval of the Company. Any unauthorized alteration, forgery or falsification of the content or appearance of this document is unlawful and offenders may be prosecuted to the fullest extent of the law. Unless otherwise stated the results shown in this test report refer only to the sample(s) tested.

# 測試報告

## Test Report

號碼(No.) : CE/2014/42639 日期(Date) : 2014/04/17 頁數(Page) : 2 of 11

鴻海精密工業股份有限公司

HON HAI PRECISION IND. CO., LTD.

新北市土城區自由街2號

NO. 2, ZIHYOU ST., TUCHENG DIST., NEW TAIPEI CITY 23678, TAIWAN (R. O. C.)



### 測試結果(Test Results)

測試部位(PART NAME)No.1 : 白色粉末 (WHITE POWDER)

測試項目 (Test Items)	單位 (Unit)	測試方法 (Method)	方法偵測 極限值 (MDL)	結果 (Result)
				No.1
鎘 / Cadmium (Cd)	mg/kg	參考IEC 62321-5: 2013方法, 以感應耦合電漿原子發射光譜儀檢測. / With reference to IEC 62321-5: 2013 and performed by ICP-AES.	2	n.d.
鉛 / Lead (Pb)	mg/kg	參考IEC 62321-5: 2013方法, 以感應耦合電漿原子發射光譜儀檢測. / With reference to IEC 62321-5: 2013 and performed by ICP-AES.	2	n.d.
汞 / Mercury (Hg)	mg/kg	參考IEC 62321-4: 2013方法, 以感應耦合電漿原子發射光譜儀檢測. / With reference to IEC 62321-4: 2013 and performed by ICP-AES.	2	n.d.
六價鉻 / Hexavalent Chromium Cr(VI)	mg/kg	參考IEC 62321: 2008方法, 以UV-VIS檢測. / With reference to IEC 62321: 2008 and performed by UV-VIS.	2	n.d.
銻 / Antimony (Sb)	mg/kg	參考US EPA 3052方法, 以感應耦合電漿原子發射光譜儀檢測. / With reference to US EPA Method 3052. Analysis was performed by ICP-AES.	2	n.d.
砷 / Arsenic (As)	mg/kg	參考US EPA 3052方法, 以感應耦合電漿原子發射光譜儀檢測. / With reference to US EPA Method 3052. Analysis was performed by ICP-AES.	2	n.d.

This document is issued by the Company subject to its General Conditions of Service printed overleaf, available on request or accessible at <http://www.sgs.com/en/Terms-and-Conditions.aspx> and, for electronic format documents, subject to Terms and Conditions for Electronic Documents at <http://www.sgs.com/en/Terms-and-Conditions/Termse-Documents.aspx>. Attention is drawn to the limitation of liability, indemnification and jurisdiction issues defined therein. Any holder of this document is advised that information contained hereon reflects the Company's findings at the time of its intervention only and within the limits of client's instruction, if any. The Company's sole responsibility is to its Client and this document does not exonerate parties to a transaction from exercising all their rights and obligations under the transaction documents. This document cannot be reproduced, except in full, without prior written approval of the Company. Any unauthorized alteration, forgery or falsification of the content or appearance of this document is unlawful and offenders may be prosecuted to the fullest extent of the law. Unless otherwise stated the results shown in this test report refer only to the sample(s) tested.

# 測試報告

## Test Report

號碼(No.) : CE/2014/42639 日期(Date) : 2014/04/17 頁數(Page) : 3 of 11

鴻海精密工業股份有限公司

HON HAI PRECISION IND. CO., LTD.

新北市土城區自由街2號

NO. 2, ZIHYOU ST., TUCHENG DIST., NEW TAIPEI CITY 23678, TAIWAN (R. O. C.)



測試項目 (Test Items)	單位 (Unit)	測試方法 (Method)	方法偵測 極限值 (MDL)	結果 (Result)
				No.1
鈹 / Beryllium (Be)	mg/kg	參考US EPA 3052方法, 以感應耦合電漿原子發射光譜儀檢測. / With reference to US EPA Method 3052. Analysis was performed by ICP-AES.	2	n.d.
全氟辛烷磺酸 / Perfluorooctane sulfonates (PFOS-Acid, Metal Salt, Amide)	mg/kg	參考US EPA 3550C: 2007方法, 以液相層析/質譜儀檢測. / With reference to US EPA 3550C: 2007. Analysis was performed by LC/MS.	10	n.d.
全氟辛酸 / PFOA (CAS No.: 335-67-1)	mg/kg	參考US EPA 3550C: 2007方法, 以液相層析/質譜儀檢測. / With reference to US EPA 3550C: 2007. Analysis was performed by LC/MS.	10	n.d.
<b>鹵素 / Halogen</b>				
鹵素 (氟) / Halogen-Fluorine (F) (CAS No.: 14762-94-8)	mg/kg	參考BS EN 14582:2007, 以離子層析儀分析. / With reference to BS EN 14582:2007. Analysis was performed by IC.	50	n.d.
鹵素 (氯) / Halogen-Chlorine (Cl) (CAS No.: 22537-15-1)	mg/kg		50	n.d.
鹵素 (溴) / Halogen-Bromine (Br) (CAS No.: 10097-32-2)	mg/kg		50	n.d.
鹵素 (碘) / Halogen-Iodine (I) (CAS No.: 14362-44-8)	mg/kg		50	n.d.

This document is issued by the Company subject to its General Conditions of Service printed overleaf, available on request or accessible at <http://www.sgs.com/en/Terms-and-Conditions.aspx> and, for electronic format documents, subject to Terms and Conditions for Electronic Documents at <http://www.sgs.com/en/Terms-and-Conditions/Termse-Documents.aspx>. Attention is drawn to the limitation of liability, indemnification and jurisdiction issues defined therein. Any holder of this document is advised that information contained hereon reflects the Company's findings at the time of its intervention only and within the limits of client's instruction, if any. The Company's sole responsibility is to its Client and this document does not exonerate parties to a transaction from exercising all their rights and obligations under the transaction documents. This document cannot be reproduced, except in full, without prior written approval of the Company. Any unauthorized alteration, forgery or falsification of the content or appearance of this document is unlawful and offenders may be prosecuted to the fullest extent of the law. Unless otherwise stated the results shown in this test report refer only to the sample(s) tested.

# 測試報告

## Test Report

號碼(No.) : CE/2014/42639 日期(Date) : 2014/04/17 頁數(Page) : 4 of 11

鴻海精密工業股份有限公司

HON HAI PRECISION IND. CO., LTD.

新北市土城區自由街2號

NO. 2, ZIHYOU ST., TUCHENG DIST., NEW TAIPEI CITY 23678, TAIWAN (R. O. C.)



測試項目 (Test Items)	單位 (Unit)	測試方法 (Method)	方法偵測 極限值 (MDL)	結果 (Result)
				No.1
多溴聯苯總和 / Sum of PBBs	mg/kg	參考 IEC 62321: 2008 方法, 以氣相層析/質譜儀檢測. / With reference to IEC 62321: 2008 and performed by GC/MS.	-	n.d.
一溴聯苯 / Monobromobiphenyl	mg/kg		5	n.d.
二溴聯苯 / Dibromobiphenyl	mg/kg		5	n.d.
三溴聯苯 / Tribromobiphenyl	mg/kg		5	n.d.
四溴聯苯 / Tetrabromobiphenyl	mg/kg		5	n.d.
五溴聯苯 / Pentabromobiphenyl	mg/kg		5	n.d.
六溴聯苯 / Hexabromobiphenyl	mg/kg		5	n.d.
七溴聯苯 / Heptabromobiphenyl	mg/kg		5	n.d.
八溴聯苯 / Octabromobiphenyl	mg/kg		5	n.d.
九溴聯苯 / Nonabromobiphenyl	mg/kg		5	n.d.
十溴聯苯 / Decabromobiphenyl	mg/kg		5	n.d.
多溴聯苯醚總和 / Sum of PBDEs	mg/kg		-	n.d.
一溴聯苯醚 / Monobromodiphenyl ether	mg/kg		5	n.d.
二溴聯苯醚 / Dibromodiphenyl ether	mg/kg		5	n.d.
三溴聯苯醚 / Tribromodiphenyl ether	mg/kg		5	n.d.
四溴聯苯醚 / Tetrabromodiphenyl ether	mg/kg		5	n.d.
五溴聯苯醚 / Pentabromodiphenyl ether	mg/kg		5	n.d.
六溴聯苯醚 / Hexabromodiphenyl ether	mg/kg		5	n.d.
七溴聯苯醚 / Heptabromodiphenyl ether	mg/kg		5	n.d.
八溴聯苯醚 / Octabromodiphenyl ether	mg/kg		5	n.d.
九溴聯苯醚 / Nonabromodiphenyl ether	mg/kg	5	n.d.	
十溴聯苯醚 / Decabromodiphenyl ether	mg/kg	5	n.d.	

This document is issued by the Company subject to its General Conditions of Service printed overleaf, available on request or accessible at <http://www.sgs.com/en/Terms-and-Conditions.aspx> and, for electronic format documents, subject to Terms and Conditions for Electronic Documents at <http://www.sgs.com/en/Terms-and-Conditions/Termse-Document.aspx>. Attention is drawn to the limitation of liability, indemnification and jurisdiction issues defined therein. Any holder of this document is advised that information contained hereon reflects the Company's findings at the time of its intervention only and within the limits of client's instruction, if any. The Company's sole responsibility is to its Client and this document does not exonerate parties to a transaction from exercising all their rights and obligations under the transaction documents. This document cannot be reproduced, except in full, without prior written approval of the Company. Any unauthorized alteration, forgery or falsification of the content or appearance of this document is unlawful and offenders may be prosecuted to the fullest extent of the law. Unless otherwise stated the results shown in this test report refer only to the sample(s) tested.



## 測試報告

## Test Report

號碼(No.) : CE/2014/42639 日期(Date) : 2014/04/17 頁數(Page) : 5 of 11

鴻海精密工業股份有限公司

HON HAI PRECISION IND. CO., LTD.

新北市土城區自由街2號

NO. 2, ZIHYOU ST., TUCHENG DIST., NEW TAIPEI CITY 23678, TAIWAN (R. O. C.)



### 備註(Note) :

1. mg/kg = ppm ; 0.1wt% = 1000ppm
2. n.d. = Not Detected (未檢出)
3. MDL = Method Detection Limit (方法偵測極限值)
4. "-" = Not Regulated (無規格值)

### PFOS參考資訊(Reference Information) : 持久性有機污染物 POPs - (EU) 757/2010

PFOS濃度在物質或製備中不得超過0.001%(10ppm), 在半成品、成品或零部件中不得超過0.1%(1000ppm), 在紡織品或塗層材料中不得超過 $1\mu\text{g}/\text{m}^2$ 。

(Outlawing PFOS as substances or preparations in concentrations above 0.001% (10ppm), in semi-finished products or articles or parts at a level above 0.1%(1000ppm), in textiles or other coated materials above  $1\mu\text{g}/\text{m}^2$ .)

## 測試報告

## Test Report

號碼(No.) : CE/2014/42639 日期(Date) : 2014/04/17 頁數(Page) : 6 of 11

鴻海精密工業股份有限公司

HON HAI PRECISION IND. CO., LTD.

新北市土城區自由街2號

NO. 2, ZIHYOU ST., TUCHENG DIST., NEW TAIPEI CITY 23678, TAIWAN (R. O. C.)



- 1) 根據以下的流程圖之條件，樣品已完全溶解。(六價鉻測試方法除外) / These samples were dissolved totally by pre-conditioning method according to below flow chart. (Cr<sup>6+</sup> test method excluded)
- 2) 測試人員：楊登偉 / Name of the person who made measurement: Climbgreat Yang
- 3) 測試負責人：張啓興 / Name of the person in charge of measurement: Troy Chang

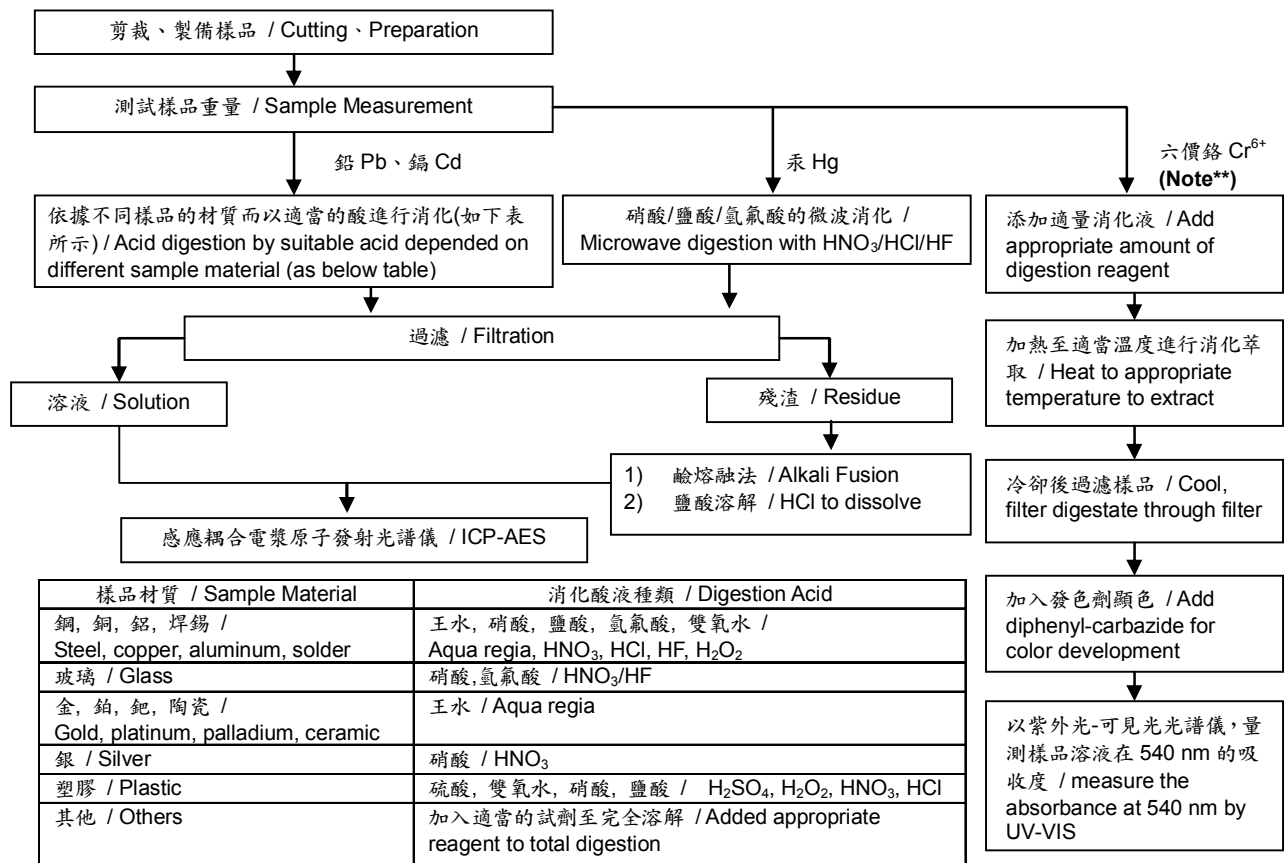

### Note\*\* (For IEC 62321)

- (1) 針對非金屬材料加入鹼性消化液，加熱至 90~95°C 萃取。 / For non-metallic material, add alkaline digestion reagent and heat to 90~95°C.
- (2) 針對金屬材料加入純水，加熱至沸騰萃取。 / For metallic material, add pure water and heat to boiling.

## 測試報告

## Test Report

號碼(No.) : CE/2014/42639 日期(Date) : 2014/04/17 頁數(Page) : 7 of 11

鴻海精密工業股份有限公司

HON HAI PRECISION IND. CO., LTD.

新北市土城區自由街2號

NO. 2, ZIHYOU ST., TUCHENG DIST., NEW TAIPEI CITY 23678, TAIWAN (R. O. C.)



- 1) 根據以下的流程圖之條件，樣品已完全溶解。 / These samples were dissolved totally by pre-conditioning method according to below flow chart.
- 2) 測試人員：楊登偉 / Name of the person who made measurement: Climbgreat Yang
- 3) 測試負責人：張啓興 / Name of the person in charge of measurement: Troy Chang

### 元素以 ICP-AES 分析的消化流程圖

(Flow Chart of digestion for the elements analysis performed by ICP-AES)

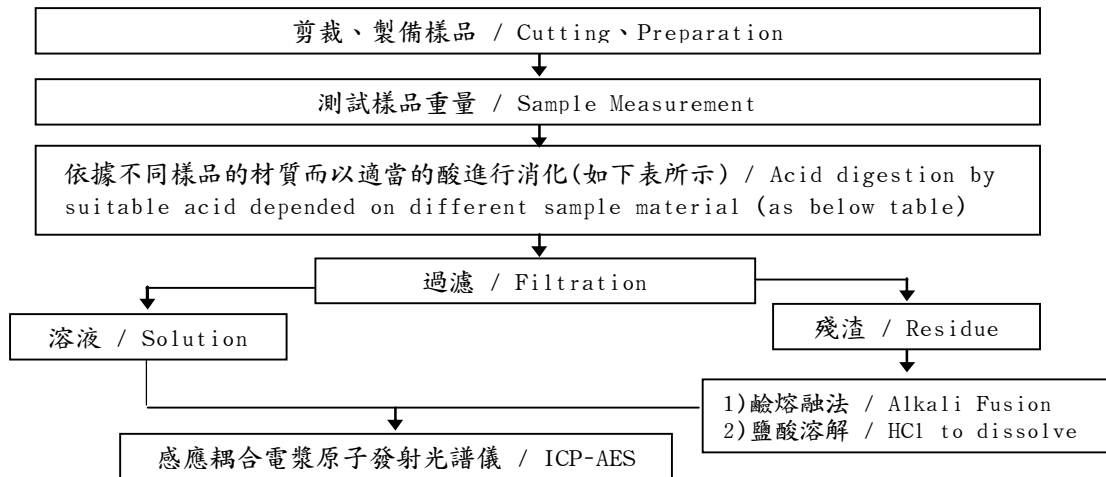

鋼, 銅, 鋁, 焊錫 / Steel, copper, aluminum, solder	王水, 硝酸, 鹽酸, 氫氟酸, 雙氧水 / Aqua regia, HNO <sub>3</sub> , HCl, HF, H <sub>2</sub> O <sub>2</sub>
玻璃 / Glass	硝酸, 氫氟酸 / HNO <sub>3</sub> /HF
金, 鉑, 鈀, 陶瓷 / Gold, platinum, palladium, ceramic	王水 / Aqua regia
銀 / Silver	硝酸 / HNO <sub>3</sub>
塑膠 / Plastic	硫酸, 雙氧水, 硝酸, 鹽酸 / H <sub>2</sub> SO <sub>4</sub> , H <sub>2</sub> O <sub>2</sub> , HNO <sub>3</sub> , HCl
其他 / Others	加入適當的試劑至完全溶解 / Added appropriate reagent to total digestion

## 測試報告

## Test Report

號碼(No.) : CE/2014/42639 日期(Date) : 2014/04/17 頁數(Page) : 8 of 11

鴻海精密工業股份有限公司

HON HAI PRECISION IND. CO., LTD.

新北市土城區自由街2號

NO. 2, ZIHYOU ST., TUCHENG DIST., NEW TAIPEI CITY 23678, TAIWAN (R. O. C.)



### 全氟辛酸/全氟辛烷磺酸分析流程圖 / PFOA/PFOS analytical flow chart

- 測試人員：翁賜彬 / Name of the person who made measurement: Roman Wong
- 測試負責人：張啓興 / Name of the person in charge of measurement: Troy Chang

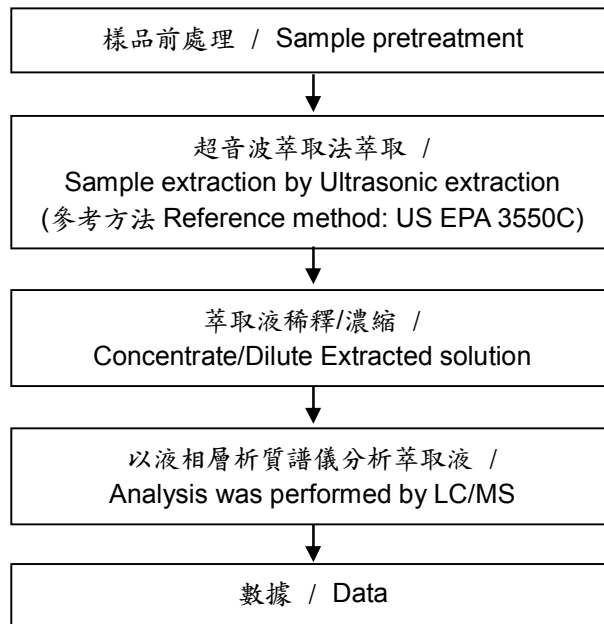

## 測試報告

## Test Report

號碼(No.) : CE/2014/42639 日期(Date) : 2014/04/17 頁數(Page) : 9 of 11

鴻海精密工業股份有限公司

HON HAI PRECISION IND. CO., LTD.

新北市土城區自由街2號

NO. 2, ZIHYOU ST., TUCHENG DIST., NEW TAIPEI CITY 23678, TAIWAN (R. O. C.)



### 鹵素分析流程圖 / Analytical flow chart of halogen content

- 測試人員：陳恩臻 / Name of the person who made measurement: Rita Chen
- 測試負責人：張啓興 / Name of the person in charge of measurement: Troy Chang

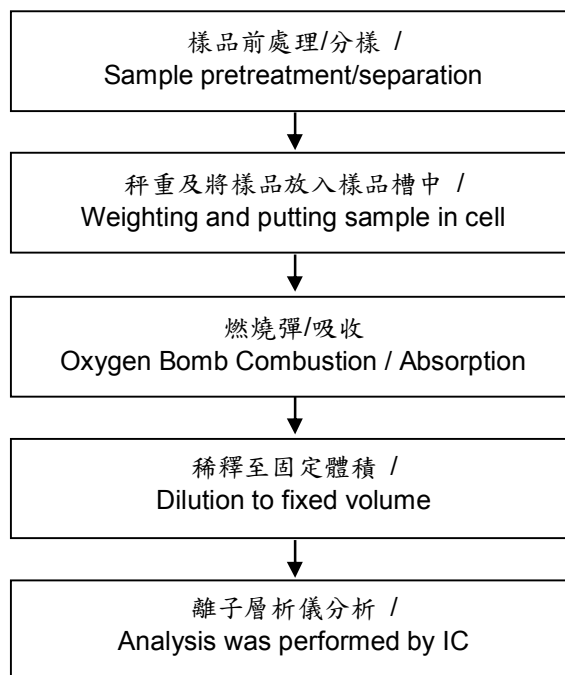

## 測試報告

## Test Report

號碼(No.) : CE/2014/42639 日期(Date) : 2014/04/17 頁數(Page) : 10 of 11

鴻海精密工業股份有限公司

HON HAI PRECISION IND. CO., LTD.

新北市土城區自由街2號

NO. 2, ZIHYOU ST., TUCHENG DIST., NEW TAIPEI CITY 23678, TAIWAN (R. O. C.)



### 多溴聯苯/多溴聯苯醚分析流程圖 / PBB/PBDE analytical FLOW CHART

- 測試人員：翁賜彬 / Name of the person who made measurement: Roman Wong
- 測試負責人：張啓興 / Name of the person in charge of measurement: Troy Chang

初次測試程序 / First testing process —————>

選擇性篩檢程序 / Optional screen process .....>

確認程序 / Confirmation process - - ->

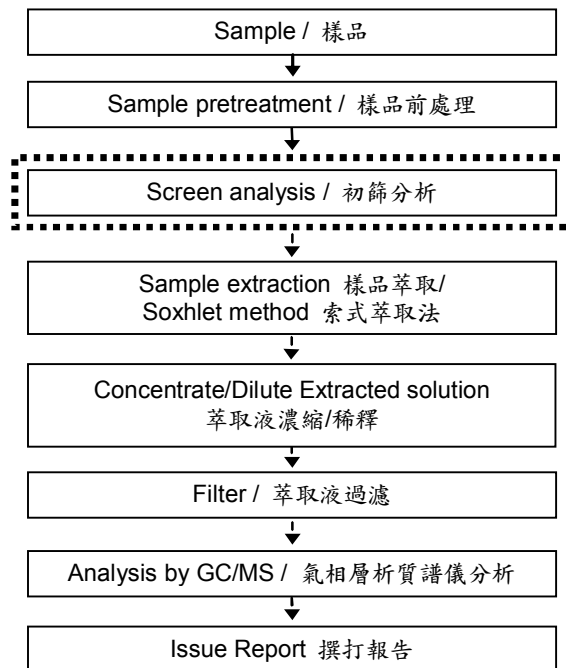

This document is issued by the Company subject to its General Conditions of Service printed overleaf, available on request or accessible at <http://www.sgs.com/en/Terms-and-Conditions.aspx> and, for electronic format documents, subject to Terms and Conditions for Electronic Documents at <http://www.sgs.com/en/Terms-and-Conditions/Termse-Document.aspx>. Attention is drawn to the limitation of liability, indemnification and jurisdiction issues defined therein. Any holder of this document is advised that information contained hereon reflects the Company's findings at the time of its intervention only and within the limits of client's instruction, if any. The Company's sole responsibility is to its Client and this document does not exonerate parties to a transaction from exercising all their rights and obligations under the transaction documents. This document cannot be reproduced, except in full, without prior written approval of the Company. Any unauthorized alteration, forgery or falsification of the content or appearance of this document is unlawful and offenders may be prosecuted to the fullest extent of the law. Unless otherwise stated the results shown in this test report refer only to the sample(s) tested.



## 測試報告

## Test Report

號碼(No.) : CE/2014/42639 日期(Date) : 2014/04/17 頁數(Page) : 11 of 11

鴻海精密工業股份有限公司

HON HAI PRECISION IND. CO., LTD.

新北市土城區自由街2號

NO. 2, ZIHYOU ST., TUCHENG DIST., NEW TAIPEI CITY 23678, TAIWAN (R. O. C.)



\* 照片中如有箭頭標示，則表示為實際檢測之樣品/部位。\*  
(The tested sample / part is marked by an arrow if it's shown on the photo.)

# CE/2014/42639



\*\* 報告結尾 (End of Report) \*\*

This document is issued by the Company subject to its General Conditions of Service printed overleaf, available on request or accessible at <http://www.sgs.com/en/Terms-and-Conditions.aspx> and, for electronic format documents, subject to Terms and Conditions for Electronic Documents at <http://www.sgs.com/en/Terms-and-Conditions/Termse-Document.aspx>. Attention is drawn to the limitation of liability, indemnification and jurisdiction issues defined therein. Any holder of this document is advised that information contained hereon reflects the Company's findings at the time of its intervention only and within the limits of client's instruction, if any. The Company's sole responsibility is to its Client and this document does not exonerate parties to a transaction from exercising all their rights and obligations under the transaction documents. This document cannot be reproduced, except in full, without prior written approval of the Company. Any unauthorized alteration, forgery or falsification of the content or appearance of this document is unlawful and offenders may be prosecuted to the fullest extent of the law. Unless otherwise stated the results shown in this test report refer only to the sample(s) tested.

## 測試報告 Test Report

號碼(No.) : KA/2014/C1451 日期(Date) : 2014/12/27 頁數(Page) : 1 of 27

金居開發股份有限公司  
CO-TECH DEVELOPMENT CORP.  
64064雲林縣斗六市科工八路56號  
NO. 56, KOUKONG 8 ROAD, TOULIEU, YUN LIN, TAIWAN, R. O. C.

以下測試樣品係由客戶送樣，且由客戶聲稱並經客戶確認如下

(The following samples was/were submitted and identified by/on behalf of the client as) :

樣品名稱(Sample Description)	: 電解銅箔
樣品型號(Style/Item No.)	: SD101
訂單號碼(Order No.)	: 4500031611
收件日期(Sample Receiving Date)	: 2014/12/18
測試期間(Testing Period)	: 2014/12/18 TO 2014/12/27
送樣廠商(Sample Submitted By)	: 金居開發股份有限公司 (CO-TECH DEVELOPMENT CORP.)

=====  
測試結果(Test Results) : 請見下一頁 (Please refer to next pages).

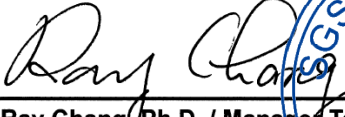
  
Ray Chang, Ph.D. / Manager-Technical  
Signed for and on behalf of  
SGS Taiwan Limited  
Chemical Laboratory-Kaohsiung



Unless otherwise stated the results shown in this test report refer only to the sample(s) tested. This test report cannot be reproduced, except in full, without prior written permission of the Company. 除非另有說明，此報告結果僅對測試之樣品負責。本報告未經本公司書面許可，不可部分複製。  
This document is issued by the Company subject to its General Conditions of Service printed overleaf, available on request or accessible at [www.sgs.com/terms\\_and\\_conditions.htm](http://www.sgs.com/terms_and_conditions.htm) and, for electronic format documents, subject to Terms and Conditions for Electronic Documents at [www.sgs.com/terms\\_e-document.htm](http://www.sgs.com/terms_e-document.htm). Attention is drawn to the limitation of liability, indemnification and jurisdiction issues defined therein. Any holder of this document is advised that information contained hereon reflects the Company's findings at the time of its intervention only and within the limits of Client's instructions, if any. The Company's sole responsibility is to its Client and this document does not exonerate parties to a transaction from exercising all their rights and obligations under the transaction documents. This document cannot be reproduced except in full, without prior written approval of the Company. Any unauthorized alteration, forgery or falsification of the content or appearance of this document is unlawful and offenders may be prosecuted to the fullest extent of the law.

# 測試報告 Test Report

號碼(No.) : KA/2014/C1451 日期(Date) : 2014/12/27 頁數(Page) : 2 of 27

金居開發股份有限公司  
CO-TECH DEVELOPMENT CORP.  
64064 雲林縣斗六市科工八路56號  
NO. 56, KOUKONG 8 ROAD, TOULIEU, YUN LIN, TAIWAN, R. O. C.

## 測試結果(Test Results)

測試部位(PART NAME) NO.1 : 紅銅色/灰色 電解銅箔 (RED COPPER/GREY 電解銅箔)

測試項目 (Test Items)	單位 (Unit)	測試方法 (Method)	方法偵測 極限值 (MDL)	結果 (Result)
				NO.1
鎘 / Cadmium (Cd)	mg/kg	參考IEC 62321-5: 2013方法, 以感應耦合電漿原子發射光譜儀檢測. / With reference to IEC 62321-5: 2013 and performed by ICP-AES.	2	n.d.
鉛 / Lead (Pb)	mg/kg	參考IEC 62321-5: 2013方法, 以感應耦合電漿原子發射光譜儀檢測. / With reference to IEC 62321-5: 2013 and performed by ICP-AES.	2	n.d.
汞 / Mercury (Hg)	mg/kg	參考IEC 62321-4: 2013方法, 以感應耦合電漿原子發射光譜儀檢測. / With reference to IEC 62321-4: 2013 and performed by ICP-AES.	2	n.d.
六價鉻 / Hexavalent Chromium Cr(VI) by boiling water extraction#	**	參考IEC 62321: 2008方法, 用Boiling water extraction方法檢測. / With reference to IEC 62321: 2008 and performed by boiling water extraction Method.	0.02mg/kg with 50 cm <sup>2</sup> surface area	Negative
多溴聯苯總和 / Sum of PBBs	mg/kg	參考IEC 62321: 2008方法, 以氣相層析儀/質譜儀檢測. / With reference to IEC 62321: 2008 and performed by GC/MS.	-	n.d.
一溴聯苯 / Monobromobiphenyl			5	n.d.
二溴聯苯 / Dibromobiphenyl			5	n.d.
三溴聯苯 / Tribromobiphenyl			5	n.d.
四溴聯苯 / Tetrabromobiphenyl			5	n.d.
五溴聯苯 / Pentabromobiphenyl			5	n.d.
六溴聯苯 / Hexabromobiphenyl			5	n.d.
七溴聯苯 / Heptabromobiphenyl			5	n.d.
八溴聯苯 / Octabromobiphenyl			5	n.d.
九溴聯苯 / Nonabromobiphenyl			5	n.d.
十溴聯苯 / Decabromobiphenyl	5	n.d.		

Unless otherwise stated the results shown in this test report refer only to the sample(s) tested. This test report cannot be reproduced, except in full, without prior written permission of the Company. 除非另有說明, 此報告結果僅對測試之樣品負責。本報告未經本公司書面許可, 不可部分複製。  
This document is issued by the Company subject to its General Conditions of Service printed overleaf, available on request or accessible at [www.sgs.com/terms\\_and\\_conditions.htm](http://www.sgs.com/terms_and_conditions.htm) and, for electronic format documents, subject to Terms and Conditions for Electronic Documents at [www.sgs.com/terms\\_e-document.htm](http://www.sgs.com/terms_e-document.htm). Attention is drawn to the limitation of liability, indemnification and jurisdiction issues defined therein. Any holder of this document is advised that information contained hereon reflects the Company's findings at the time of its intervention only and within the limits of Client's instructions, if any. The Company's sole responsibility is to its Client and this document does not exonerate parties to a transaction from exercising all their rights and obligations under the transaction documents. This document cannot be reproduced except in full, without prior written approval of the Company. Any unauthorized alteration, forgery or falsification of the content or appearance of this document is unlawful and offenders may be prosecuted to the fullest extent of the law.

# 測試報告

## Test Report

號碼(No.) : KA/2014/C1451 日期(Date) : 2014/12/27 頁數(Page) : 3 of 27

金居開發股份有限公司  
CO-TECH DEVELOPMENT CORP.  
64064雲林縣斗六市科工八路56號  
NO. 56, KOUKONG 8 ROAD, TOULIEU, YUN LIN, TAIWAN, R. O. C.

測試項目 (Test Items)	單位 (Unit)	測試方法 (Method)	方法偵測 極限值 (MDL)	結果 (Result)
				NO.1
<b>多溴聯苯醚總和 / Sum of PBDEs</b>	mg/kg	參考IEC 62321: 2008方法, 以氣相層析儀/質譜儀 檢測。 / With reference to IEC 62321: 2008 and performed by GC/MS.	-	n.d.
一溴聯苯醚 / Monobromodiphenyl ether			5	n.d.
二溴聯苯醚 / Dibromodiphenyl ether			5	n.d.
三溴聯苯醚 / Tribromodiphenyl ether			5	n.d.
四溴聯苯醚 / Tetrabromodiphenyl ether			5	n.d.
五溴聯苯醚 / Pentabromodiphenyl ether			5	n.d.
六溴聯苯醚 / Hexabromodiphenyl ether			5	n.d.
七溴聯苯醚 / Heptabromodiphenyl ether			5	n.d.
八溴聯苯醚 / Octabromodiphenyl ether			5	n.d.
九溴聯苯醚 / Nonabromodiphenyl ether			5	n.d.
十溴聯苯醚 / Decabromodiphenyl ether	5	n.d.		
多氯聯苯 / Polychlorinated Biphenyls (PCBs)	mg/kg	參考US EPA 3540C方法, 以氣相層析質譜儀(GC/MS) 檢測。 / With reference to US EPA 3540C method. Analysis was performed by GC/MS.	0.5	n.d.
多氯萘 / Polychlorinated Naphthalene (PCNs)	mg/kg	參考US EPA 3540C方法, 以氣相層析質譜儀(GC/MS) 檢測。 / With reference to US EPA 3540C method. Analysis was performed by GC/MS.	5	n.d.
多氯三聯苯 / Polychlorinated Terphenyls (PCTs)	mg/kg	參考US EPA 3540C方法, 以氣相層析質譜儀(GC/MS) 檢測。 / With reference to US EPA 3540C method. Analysis was performed by GC/MS.	0.5	n.d.
短鏈氯化石蠟 / Alkanes, C10-13, chloro (Short Chain Chlorinated Paraffins) (CAS No.: 085535-84-8))	%	參考US EPA 3540C: 1996方法, 以氣相層析儀/電子 補捉偵測器檢測。 / With reference to US EPA 3540C: 1996 method. Analysis was performed by GC/ECD.	0.01	n.d.
滅蟻靈 / Mirex (CAS No.: 2385-85-5)	mg/kg	參考US EPA 8270D方法, 以氣相層析質譜儀(GC/MS) 檢測。 / With reference to US EPA 8270D method. Analysis was performed by GC/MS.	4	n.d.
五氯酚 / PCP (Pentachlorophenol) (CAS No.: 87-86-5)	mg/kg	參考KOH方法, 以氣相層析儀/電子捕捉偵測器 (GC/ECD)檢測。 / With reference to KOH method. Analysis was performed by GC/ECD.	3	n.d.

Unless otherwise stated the results shown in this test report refer only to the sample(s) tested. This test report cannot be reproduced, except in full, without prior written permission of the Company. 除非另有說明, 此報告結果僅對測試之樣品負責。本報告未經本公司書面許可, 不可部分複製。  
This document is issued by the Company subject to its General Conditions of Service printed overleaf, available on request or accessible at [www.sgs.com/terms\\_and\\_conditions.htm](http://www.sgs.com/terms_and_conditions.htm) and, for electronic format documents, subject to Terms and Conditions for Electronic Documents at [www.sgs.com/terms\\_e-document.htm](http://www.sgs.com/terms_e-document.htm). Attention is drawn to the limitation of liability, indemnification and jurisdiction issues defined therein. Any holder of this document is advised that information contained hereon reflects the Company's findings at the time of its intervention only and within the limits of Client's instructions, if any. The Company's sole responsibility is to its Client and this document does not exonerate parties to a transaction from exercising all their rights and obligations under the transaction documents. This document cannot be reproduced except in full, without prior written approval of the Company. Any unauthorized alteration, forgery or falsification of the content or appearance of this document is unlawful and offenders may be prosecuted to the fullest extent of the law.

# 測試報告

## Test Report

號碼(No.) : KA/2014/C1451 日期(Date) : 2014/12/27 頁數(Page) : 4 of 27

金居開發股份有限公司

CO-TECH DEVELOPMENT CORP.

64064雲林縣斗六市科工八路56號

NO. 56, KOUKONG 8 ROAD, TOULIEU, YUN LIN, TAIWAN, R. O. C.

測試項目 (Test Items)	單位 (Unit)	測試方法 (Method)	方法偵測 極限值 (MDL)	結果 (Result)
				NO.1
四溴雙酚-A / Tetrabromobisphenol A (TBBP-A) (CAS No.: 79-94-7)	mg/kg	參考RSTS-E&E-121方法, 以液相層析/質譜儀分析。 / With reference to RSTS-E&E-121. Analysis was performed by LC/MS.	10	n.d.
福馬林 (甲醛) / Formaldehyde (CAS No.: 50-00-0)	mg/kg	參考ISO 17226-1方法, 以高效液相層析儀/二極體 陣列偵測器檢測。 / With reference to ISO 17226-1. Analysis was performed by HPLC/DAD.	3	n.d.
六溴環十二烷及所有主要被辨別出的異構物 / Hexabromocyclododecane (HBCDD) and all major diastereoisomers identified ( $\alpha$ - HBCDD, $\beta$ - HBCDD, $\gamma$ - HBCDD) (CAS No.: 25637-99-4 and 3194-55-6 (134237- 51-7, 134237-50-6, 134237-52-8))	mg/kg	參考IEC 62321: 2008方法, 以氣相層析/質譜儀檢 測。 / With reference to IEC 62321: 2008 method. Analysis was performed by GC/MS.	5	n.d.
雙酚 A / Bisphenol A (CAS No.: 80-05- 7)	mg/kg	參考RSTS-HL-229-1方法, 以液相層析/質譜儀檢測。 / With reference to RSTS-HL-229-1 method. Analysis was performed by LC/MS.	1	n.d.
富馬酸二甲酯 / Dimethyl Fumarate (CAS No.: 624-49-7)	mg/kg	參考US EPA 3550C方法, 以氣相層析質譜儀(GC/MS) 檢測。 / With reference to US EPA 3550C method. Analysis was performed by GC/MS.	0.1	n.d.
聚氯乙烯 / PVC	**	以紅外光譜分析及焰色法檢測。 / Analysis was performed by FTIR and FLAME Test.	-	Negative
全氟辛烷磺酸 (PFOS) (PFOS - Acid, Metal Salt, Amide)	$\mu\text{g}/\text{m}^2$	參考US EPA 3550C: 2007方法, 以液相層析/質譜儀 檢測。 / With reference to US EPA 3550C: 2007. Analysis was performed by LC/MS.	1	n.d.
全氟辛酸(銨) / PFOA (CAS No.: 335-67- 1)	$\mu\text{g}/\text{m}^2$	參考US EPA 3550C: 2007方法, 以液相層析/質譜儀 檢測。 / With reference to US EPA 3550C: 2007. Analysis was performed by LC/MS.	1	n.d.

Unless otherwise stated the results shown in this test report refer only to the sample(s) tested. This test report cannot be reproduced, except in full, without prior written permission of the Company. 除非另有說明, 此報告結果僅對測試之樣品負責。本報告未經本公司書面許可, 不可部分複製。  
This document is issued by the Company subject to its General Conditions of Service printed overleaf, available on request or accessible at [www.sgs.com/terms\\_and\\_conditions.htm](http://www.sgs.com/terms_and_conditions.htm) and, for electronic format documents, subject to Terms and Conditions for Electronic Documents at [www.sgs.com/terms\\_e-document.htm](http://www.sgs.com/terms_e-document.htm). Attention is drawn to the limitation of liability, indemnification and jurisdiction issues defined therein. Any holder of this document is advised that information contained hereon reflects the Company's findings at the time of its intervention only and within the limits of Client's instructions, if any. The Company's sole responsibility is to its Client and this document does not exonerate parties to a transaction from exercising all their rights and obligations under the transaction documents. This document cannot be reproduced except in full, without prior written approval of the Company. Any unauthorized alteration, forgery or falsification of the content or appearance of this document is unlawful and offenders may be prosecuted to the fullest extent of the law.



# 測試報告

## Test Report

號碼(No.) : KA/2014/C1451 日期(Date) : 2014/12/27 頁數(Page) : 5 of 27

金居開發股份有限公司  
CO-TECH DEVELOPMENT CORP.  
64064雲林縣斗六市科工八路56號  
NO. 56, KOUKONG 8 ROAD, TOULIEU, YUN LIN, TAIWAN, R. O. C.

測試項目 (Test Items)	單位 (Unit)	測試方法 (Method)	方法偵測 極限值 (MDL)	結果 (Result) NO.1
<b>有機錫 / Organic-tin compounds</b>				
三丁基錫 / Tributyl Tin (TBT)	mg/kg	本測試參考ISO 17353: 2004方法, 以氣相層析儀/ 火焰光度偵測器檢測. / With reference to ISO 17353: 2004. Analysis was performed by GC/FPD.	0.03	n.d.
三苯基錫 / Triphenyl Tin (TphT)			0.03	n.d.
三丁基錫氧化物 / Tributyl Tin Oxide (TBTO)***(CAS No.: 56-35-9)			-	n.d.
<b>鹵素 / Halogen</b>				
鹵素 (氟) / Halogen-Fluorine (F) (CAS No.: 14762-94-8)	mg/kg	參考BS EN 14582:2007, 以離子層析儀分析. / With reference to BS EN 14582:2007. Analysis was performed by IC.	50	n.d.
鹵素 (氯) / Halogen-Chlorine (Cl) (CAS No.: 22537-15-1)			50	n.d.
鹵素 (溴) / Halogen-Bromine (Br) (CAS No.: 10097-32-2)			50	n.d.
鹵素 (碘) / Halogen-Iodine (I) (CAS No.: 14362-44-8)			50	n.d.
<b>石棉 / Asbestos</b>				
陽起石棉 / Actinolite (CAS No.: 77536-66-4)	%	參考EPA 600/R-93/116 / 立體顯微鏡 (SM), 分散 染色式偏光顯微鏡 (DS-PLM)及X光繞射光譜分析法 (XRD) / With reference to EPA 600/R-93/116 method. Analysis was performed by Stereo Microscope (SM), Dispersion Staining Polarized Light Microscope (DS-PLM) and X-ray Diffraction Spectrometer (XRD).	-	Negative
斜方角閃石棉 / Anthophyllite (CAS No.: 77536-67-5)			-	Negative
鐵石棉(褐石棉) / Amosite (CAS No.: 12172-73-5)			-	Negative
溫石棉(白石棉) / Chrysotile (CAS No.: 12001-29-5)			-	Negative
青石棉 / Crocidolite (CAS No.: 12001-28-4)			-	Negative
透閃石棉 / Tremolite (CAS No.: 77536-68-6)			-	Negative

Unless otherwise stated the results shown in this test report refer only to the sample(s) tested. This test report cannot be reproduced, except in full, without prior written permission of the Company. 除非另有說明, 此報告結果僅對測試之樣品負責。本報告未經本公司書面許可, 不可部分複製。  
This document is issued by the Company subject to its General Conditions of Service printed overleaf, available on request or accessible at [www.sgs.com/terms\\_and\\_conditions.htm](http://www.sgs.com/terms_and_conditions.htm) and, for electronic format documents, subject to Terms and Conditions for Electronic Documents at [www.sgs.com/terms\\_e-document.htm](http://www.sgs.com/terms_e-document.htm). Attention is drawn to the limitation of liability, indemnification and jurisdiction issues defined therein. Any holder of this document is advised that information contained hereon reflects the Company's findings at the time of its intervention only and within the limits of Client's instructions, if any. The Company's sole responsibility is to its Client and this document does not exonerate parties to a transaction from exercising all their rights and obligations under the transaction documents. This document cannot be reproduced except in full, without prior written approval of the Company. Any unauthorized alteration, forgery or falsification of the content or appearance of this document is unlawful and offenders may be prosecuted to the fullest extent of the law.

# 測試報告

## Test Report

號碼(No.) : KA/2014/C1451 日期(Date) : 2014/12/27 頁數(Page) : 6 of 27

金居開發股份有限公司  
CO-TECH DEVELOPMENT CORP.  
64064雲林縣斗六市科工八路56號  
NO. 56, KOUKONG 8 ROAD, TOULIEU, YUN LIN, TAIWAN, R. O. C.

測試項目 (Test Items)	單位 (Unit)	測試方法 (Method)	方法偵測 極限值 (MDL)	結果 (Result)
				NO.1
<b>可塑劑定量分析 / Phthalates</b>				
鄰苯二甲酸甲苄基丁酯 / BBP (Benzyl butyl phthalate) (CAS No.: 85-68-7)	%	本測試參考EN 14372, 以氣相層析儀/質譜儀檢測之。 / With reference to EN 14372. Analysis was performed by GC/MS.	0.003	n.d.
鄰苯二甲酸-單-乙基己基酯 / MEHP (Mono(2-ethyl hexyl) Ester) (CAS No.: 4376-20-9)			0.003	n.d.
鄰苯二甲酸二環己酯 / DCHP (Di-cyclohexyl phthalate) (CAS No.: 84-61-7)			0.003	n.d.
鄰苯二甲酸二正戊酯/ DNPP(Di-n-pentyl phthalate) (CAS No.: 131-18-0)			0.003	n.d.
鄰苯二甲酸二丙酯 / DPrP (Di-propyl phthalate) (CAS No.: 131-16-8)			0.003	n.d.
鄰苯二甲酸二乙酯 / DEP (Di-ethyl phthalate) (CAS No.: 84-66-2)			0.003	n.d.
鄰苯二甲酸二己酯 / DNHP (Di-n-hexyl phthalate) (CAS No.: 84-75-3)			0.003	n.d.
鄰苯二甲酸二庚酯 / DHPP (Diheptyl Phthalate) (CAS No.: 3648-21-3)			0.003	n.d.
鄰苯二甲酸二異丁酯 / DIBP (Di-isobutyl phthalate) (CAS No.: 84-69-5)			0.003	n.d.
鄰苯二甲酸二異壬酯 / DINP (Di-isononyl phthalate) (CAS No.: 28553-12-0, 68515-48-0)			0.01	n.d.

Unless otherwise stated the results shown in this test report refer only to the sample(s) tested. This test report cannot be reproduced, except in full, without prior written permission of the Company. 除非另有說明，此報告結果僅對測試之樣品負責。本報告未經本公司書面許可，不可部分複製。  
This document is issued by the Company subject to its General Conditions of Service printed overleaf, available on request or accessible at [www.sgs.com/terms\\_and\\_conditions.htm](http://www.sgs.com/terms_and_conditions.htm) and, for electronic format documents, subject to Terms and Conditions for Electronic Documents at [www.sgs.com/terms\\_e-document.htm](http://www.sgs.com/terms_e-document.htm). Attention is drawn to the limitation of liability, indemnification and jurisdiction issues defined therein. Any holder of this document is advised that information contained hereon reflects the Company's findings at the time of its intervention only and within the limits of Client's instructions, if any. The Company's sole responsibility is to its Client and this document does not exonerate parties to a transaction from exercising all their rights and obligations under the transaction documents. This document cannot be reproduced except in full, without prior written approval of the Company. Any unauthorized alteration, forgery or falsification of the content or appearance of this document is unlawful and offenders may be prosecuted to the fullest extent of the law.

# 測試報告

## Test Report

號碼(No.) : KA/2014/C1451 日期(Date) : 2014/12/27 頁數(Page) : 7 of 27

金居開發股份有限公司  
CO-TECH DEVELOPMENT CORP.  
64064雲林縣斗六市科工八路56號  
NO. 56, KOUKONG 8 ROAD, TOULIEU, YUN LIN, TAIWAN, R. O. C.

測試項目 (Test Items)	單位 (Unit)	測試方法 (Method)	方法偵測 極限值 (MDL)	結果 (Result)
				NO.1
鄰苯二甲酸二異癸酯 / DIDP (Di-isodecyl phthalate) (CAS No.: 26761-40-0, 68515-49-1)	%	本測試參考EN 14372, 以氣相層析儀/質譜儀檢測之。 / With reference to EN 14372. Analysis was performed by GC/MS.	0.01	n.d.
鄰苯二甲酸二正壬酯 / DNNP (Di-n-nonyl phthalate)(DNP) (CAS No.: 84-76-4)			0.003	n.d.
鄰苯二甲二異辛酯 / DIOP (Di-isooctyl phthalate) (CAS No.: 27554-26-3)			0.01	n.d.
鄰苯二甲酸二苯基酯 / DPhP(Diphenyl phthalate) (CAS No.: 84-62-8)			0.003	n.d.
鄰苯二甲酸二(2-甲氧基乙基)酯 / DMEP (Bis (2-methoxyethyl) phthalate) (CAS No.: 117-82-8)			0.003	n.d.
對苯二甲酸(2-乙基己)酯 / DEHT (Di(2-ethylhexyl) terephthalate) (CAS No.: 6422-86-2)			0.003	n.d.
鄰苯二甲酸二(2-乙基己基)酯 / DEHP (Di- (2-ethylhexyl) phthalate) (CAS No.: 117-81-7)			0.003	n.d.
鄰苯二甲酸二丁酯 / DBP (Dibutyl phthalate) (CAS No.: 84-74-2)			0.003	n.d.
鄰苯二甲酸二甲酯 / DMP (Dimethyl phthalate) (CAS No.: 131-11-3)			0.003	n.d.
鄰苯二甲酸二正辛酯 / DNOP (Di-n-octyl phthalate) (CAS No.: 117-84-0)			0.003	n.d.

Unless otherwise stated the results shown in this test report refer only to the sample(s) tested. This test report cannot be reproduced, except in full, without prior written permission of the Company. 除非另有說明，此報告結果僅對測試之樣品負責。本報告未經本公司書面許可，不可部分複製。  
This document is issued by the Company subject to its General Conditions of Service printed overleaf, available on request or accessible at [www.sgs.com/terms\\_and\\_conditions.htm](http://www.sgs.com/terms_and_conditions.htm) and, for electronic format documents, subject to Terms and Conditions for Electronic Documents at [www.sgs.com/terms\\_e-document.htm](http://www.sgs.com/terms_e-document.htm). Attention is drawn to the limitation of liability, indemnification and jurisdiction issues defined therein. Any holder of this document is advised that information contained hereon reflects the Company's findings at the time of its intervention only and within the limits of Client's instructions, if any. The Company's sole responsibility is to its Client and this document does not exonerate parties to a transaction from exercising all their rights and obligations under the transaction documents. This document cannot be reproduced except in full, without prior written approval of the Company. Any unauthorized alteration, forgery or falsification of the content or appearance of this document is unlawful and offenders may be prosecuted to the fullest extent of the law.

# 測試報告

## Test Report

號碼(No.) : KA/2014/C1451 日期(Date) : 2014/12/27 頁數(Page) : 8 of 27

金居開發股份有限公司  
CO-TECH DEVELOPMENT CORP.  
64064雲林縣斗六市科工八路56號  
NO. 56, KOUKONG 8 ROAD, TOULIEU, YUN LIN, TAIWAN, R. O. C.

測試項目 (Test Items)	單位 (Unit)	測試方法 (Method)	方法偵測 極限值 (MDL)	結果 (Result)
				NO.1
己二酸二(2-乙基己基)酯 / DEHA (Bis(2-ethylhexyl) adipate) (CAS No.: 103-23-1)	%	本測試參考EN 14372, 以氣相層析儀/質譜儀檢測之。 / With reference to EN 14372. Analysis was performed by GC/MS.	0.003	n.d.
鄰苯二甲酸二苯甲基酯 / DBZP(Dibenzyl phthalate) (CAS No.: 523-31-9)			0.003	n.d.
鄰苯二甲酸正戊基異戊基酯 / nPiPP (N-pentyl-isopentylphthalate) (CAS No.: 776297-69-9)			0.003	n.d.
鄰苯二甲酸二異戊酯 / DIPP (Diisopentyl Phthalat) (CAS No.: 605-50-5)			0.003	n.d.
鄰苯二甲酸雙十一烷基酯 / DUDP (Di-n-undecyl phthalate) (CAS No.: 3648-20-2)			0.01	n.d.
鄰苯二甲酸二(C6-8支鏈與直鏈)烷基酯, 富 C7 / DIHP (1,2-Benzenedicarboxylic acid, di-C6-8-branched alkyl esters, C7-rich) (CAS No.: 71888-89-6)			0.01	n.d.
鄰苯二甲酸二(C7-11支鏈與直鏈)烷基酯 / DHNUP (1,2-Benzenedicarboxylic acid, di-C7-11-branched and linear alkyl esters) (CAS No.: 68515-42-4)			0.01	n.d.
己二酸二異壬酯 / DINA (Di-isononyl adipate) (CAS No.: 33703-08-1)			0.01	n.d.
對苯二甲酸二甲酯 / DMTP (Dimethyl terephthalate) (CAS No.: 120-61-6)			0.003	n.d.

Unless otherwise stated the results shown in this test report refer only to the sample(s) tested. This test report cannot be reproduced, except in full, without prior written permission of the Company. 除非另有說明, 此報告結果僅對測試之樣品負責。本報告未經本公司書面許可, 不可部分複製。  
This document is issued by the Company subject to its General Conditions of Service printed overleaf, available on request or accessible at [www.sgs.com/terms\\_and\\_conditions.htm](http://www.sgs.com/terms_and_conditions.htm) and, for electronic format documents, subject to Terms and Conditions for Electronic Documents at [www.sgs.com/terms\\_e-document.htm](http://www.sgs.com/terms_e-document.htm). Attention is drawn to the limitation of liability, indemnification and jurisdiction issues defined therein. Any holder of this document is advised that information contained hereon reflects the Company's findings at the time of its intervention only and within the limits of Client's instructions, if any. The Company's sole responsibility is to its Client and this document does not exonerate parties to a transaction from exercising all their rights and obligations under the transaction documents. This document cannot be reproduced except in full, without prior written approval of the Company. Any unauthorized alteration, forgery or falsification of the content or appearance of this document is unlawful and offenders may be prosecuted to the fullest extent of the law.

# 測試報告

## Test Report

號碼(No.) : KA/2014/C1451 日期(Date) : 2014/12/27 頁數(Page) : 9 of 27

金居開發股份有限公司  
CO-TECH DEVELOPMENT CORP.  
64064雲林縣斗六市科工八路56號  
NO. 56, KOUKONG 8 ROAD, TOULIEU, YUN LIN, TAIWAN, R. O. C.

測試項目 (Test Items)	單位 (Unit)	測試方法 (Method)	方法偵測 極限值 (MDL)	結果 (Result)
				NO.1
支鏈和直鏈1,2-苯二羧二戊酯 / 1,2-Benzenedicarboxylic acid, dipentylester, branched and linear (CAS No.: 84777-06-0)	%	本測試參考EN 14372, 以氣相層析儀/質譜儀檢測之。 / With reference to EN 14372. Analysis was performed by GC/MS.	0.003	n.d.
鄰苯二甲酸二癸酯 / DNDP (Di-n-decyl phthalate) (CAS No.: 87-77-5)			0.003	n.d.
鄰苯二甲酸二烯丙酯 / DAP (Diallyl phthalate) (CAS No.: 131-17-9)			0.003	n.d.
鄰苯二甲酸二(2-丁氧基)乙酯 / DBEP (Bis(2-n-Butoxyethyl)phthalate) (CAS No.: 117-83-9)			0.003	n.d.
鄰苯二甲酸二(2-乙氧基)乙酯 / DEEP (bis(2-Ethoxyethyl)phthalate) (CAS No.: 605-54-9)			0.003	n.d.
鄰苯二甲酸二(4-甲基-2-戊基)酯 / BMPP (Di(4-methyl-2-Pentyl)phthalate) (CAS No.: 146-50-9)			0.003	n.d.

Unless otherwise stated the results shown in this test report refer only to the sample(s) tested. This test report cannot be reproduced, except in full, without prior written permission of the Company. 除非另有說明，此報告結果僅對測試之樣品負責。本報告未經本公司書面許可，不可部分複製。  
This document is issued by the Company subject to its General Conditions of Service printed overleaf, available on request or accessible at [www.sgs.com/terms\\_and\\_conditions.htm](http://www.sgs.com/terms_and_conditions.htm) and, for electronic format documents, subject to Terms and Conditions for Electronic Documents at [www.sgs.com/terms\\_e-document.htm](http://www.sgs.com/terms_e-document.htm). Attention is drawn to the limitation of liability, indemnification and jurisdiction issues defined therein. Any holder of this document is advised that information contained hereon reflects the Company's findings at the time of its intervention only and within the limits of Client's instructions, if any. The Company's sole responsibility is to its Client and this document does not exonerate parties to a transaction from exercising all their rights and obligations under the transaction documents. This document cannot be reproduced except in full, without prior written approval of the Company. Any unauthorized alteration, forgery or falsification of the content or appearance of this document is unlawful and offenders may be prosecuted to the fullest extent of the law.



# 測試報告

## Test Report

號碼(No.) : KA/2014/C1451 日期(Date) : 2014/12/27 頁數(Page) : 10 of 27

金居開發股份有限公司  
CO-TECH DEVELOPMENT CORP.  
64064雲林縣斗六市科工八路56號  
NO. 56, KOUKONG 8 ROAD, TOULIEU, YUN LIN, TAIWAN, R. O. C.

測試項目 (Test Items)	單位 (Unit)	測試方法 (Method)	方法偵測 極限值 (MDL)	結果 (Result)
				NO.1
<b>偶氮 (AZO)</b>				
1): 4-氨基二苯 / 4-AMINODIPHENYL (CAS No.: 92-67-1)	mg/kg	本測試參考EN 14362-1方法, 以氣相層析質譜儀(GC/MS)檢測. / With reference to EN 14362-1. Analysis was performed by GC/MS.	3	n.d.
2): 聯苯胺 / BENZIDINE (CAS No.: 92-87-5)			3	n.d.
3): 4-氯鄰甲苯胺 / 4-CHLORO-O-TOLUIDINE (CAS No.: 95-69-2)			3	n.d.
4): 2-萘胺 / 2-NAPHTHYLAMINE (CAS No.: 91-59-8)			3	n.d.
5): 鄰氨基二甲基偶氮 / O-AMINOAZOTOLUENE (CAS No.: 97-56-3)			3	n.d.
6): 對硝基鄰甲苯胺 / 2-AMINO-4-NITROTOLUENE (CAS No.: 99-55-8)			3	n.d.
7): 對氯苯胺 / P-CHLOROANILINE (CAS No.: 106-47-8)			3	n.d.
8): 4-甲氧基-間苯二胺 / 2,4-DIAMINOANISOLE (CAS No.: 615-05-4)			3	n.d.
9): 4,4'-二氨基二苯甲烷 / 4,4'-DIAMINODIPHENYLMETHANE (CAS No.: 101-77-9)			3	n.d.
10): 3,3'-二氯聯苯胺 / 3,3'-DICHLOROBENZIDINE (CAS No.: 91-94-1)			3	n.d.
11): 3,3'-二甲氧基聯苯胺 / 3,3'-DIMETHOXYBENZIDINE (CAS No.: 119-90-4)			3	n.d.
12): 3,3'-二甲基聯苯胺 / 3,3'-DIMETHYLBENZIDINE (CAS No.: 119-93-7)			3	n.d.

Unless otherwise stated the results shown in this test report refer only to the sample(s) tested. This test report cannot be reproduced, except in full, without prior written permission of the Company. 除非另有說明, 此報告結果僅對測試之樣品負責。本報告未經本公司書面許可, 不可部分複製。  
This document is issued by the Company subject to its General Conditions of Service printed overleaf, available on request or accessible at [www.sgs.com/terms\\_and\\_conditions.htm](http://www.sgs.com/terms_and_conditions.htm) and, for electronic format documents, subject to Terms and Conditions for Electronic Documents at [www.sgs.com/terms\\_e-document.htm](http://www.sgs.com/terms_e-document.htm). Attention is drawn to the limitation of liability, indemnification and jurisdiction issues defined therein. Any holder of this document is advised that information contained hereon reflects the Company's findings at the time of its intervention only and within the limits of Client's instructions, if any. The Company's sole responsibility is to its Client and this document does not exonerate parties to a transaction from exercising all their rights and obligations under the transaction documents. This document cannot be reproduced except in full, without prior written approval of the Company. Any unauthorized alteration, forgery or falsification of the content or appearance of this document is unlawful and offenders may be prosecuted to the fullest extent of the law.

# 測試報告

## Test Report

號碼(No.) : KA/2014/C1451 日期(Date) : 2014/12/27 頁數(Page) : 11 of 27

金居開發股份有限公司  
CO-TECH DEVELOPMENT CORP.  
64064雲林縣斗六市科工八路56號  
NO. 56, KOUKONG 8 ROAD, TOULIEU, YUN LIN, TAIWAN, R. O. C.

測試項目 (Test Items)	單位 (Unit)	測試方法 (Method)	方法偵測 極限值 (MDL)	結果 (Result)
				NO.1
13): 3,3'-二甲基-4,4'-二氨基二苯甲烷 / 3,3'-DIMETHYL-4,4'-DIAMINODIPHENYLMETHANE (CAS No.: 838-88-0)	mg/kg	本測試參考EN 14362-1方法, 以氣相層析質譜儀(GC/MS)檢測。 / With reference to EN 14362-1. Analysis was performed by GC/MS.	3	n.d.
14): 2-甲氧基-5-甲基聯苯 / P-CRESIDINE (2-METHOXY-5-METHYLANILINE) (CAS No.: 120-71-8)			3	n.d.
15): 4,4'-亞甲基雙(氯苯胺) / 4,4'-METHYLENE-BIS-(2-CHLOROANILINE) (CAS No.: 101-14-4)			3	n.d.
16): 4,4'-氧化雙苯胺 / 4,4'-OXYDIANILINE (CAS No.: 101-80-4)			3	n.d.
17): 4,4'-硫代雙苯胺 / 4,4'-THIODIANILINE (CAS No.: 139-65-1)			3	n.d.
18): 鄰甲苯胺 / O-TOLUIDINE (CAS No.: 95-53-4)			3	n.d.
19): 2,4-二氨基甲苯 / 2,4-TOLUYLENEDIAMINE (CAS No.: 95-80-7)			3	n.d.
20): 2,4,5-三甲基苯胺 / 2,4,5-TRIMETHYLANILINE (CAS No.: 137-17-7)			3	n.d.
21): 鄰位甲氧基苯胺 / O-ANISIDINE (CAS No.: 90-04-0)			3	n.d.
22): 對氨基偶氮苯 / P-AMINOAZOBENZENE (CAS No.: 60-09-3)			3	n.d.
23): 2,4-二甲基苯胺 / 2,4-XYLIDINE (CAS No.: 95-68-1)			3	n.d.
24): 2,6-二甲基苯胺 / 2,6-XYLIDINE (CAS No.: 87-62-7)			3	n.d.

Unless otherwise stated the results shown in this test report refer only to the sample(s) tested. This test report cannot be reproduced, except in full, without prior written permission of the Company. 除非另有說明, 此報告結果僅對測試之樣品負責。本報告未經本公司書面許可, 不可部分複製。  
This document is issued by the Company subject to its General Conditions of Service printed overleaf, available on request or accessible at [www.sgs.com/terms\\_and\\_conditions.htm](http://www.sgs.com/terms_and_conditions.htm) and, for electronic format documents, subject to Terms and Conditions for Electronic Documents at [www.sgs.com/terms\\_e-document.htm](http://www.sgs.com/terms_e-document.htm). Attention is drawn to the limitation of liability, indemnification and jurisdiction issues defined therein. Any holder of this document is advised that information contained hereon reflects the Company's findings at the time of its intervention only and within the limits of Client's instructions, if any. The Company's sole responsibility is to its Client and this document does not exonerate parties to a transaction from exercising all their rights and obligations under the transaction documents. This document cannot be reproduced except in full, without prior written approval of the Company. Any unauthorized alteration, forgery or falsification of the content or appearance of this document is unlawful and offenders may be prosecuted to the fullest extent of the law.

## 測試報告 Test Report

號碼(No.) : KA/2014/C1451 日期(Date) : 2014/12/27 頁數(Page) : 12 of 27

金居開發股份有限公司  
CO-TECH DEVELOPMENT CORP.  
64064雲林縣斗六市科工八路56號  
NO. 56, KOUKONG 8 ROAD, TOULIEU, YUN LIN, TAIWAN, R. O. C.

### 備註(Note) :

1. mg/kg = ppm ; 0.1wt% = 1000ppm
2. n.d. = Not Detected (未檢出)
3. MDL = Method Detection Limit (方法偵測極限值)
4. "-" = Not Regulated (無規格值)
5. # = a. Positive means the presence of CrVI on the tested areas  
(Positive表示測試區域偵測到六價鉻)  
b. Negative means the absence of CrVI on the tested areas  
(Negative表示測試區域未偵測到六價鉻)

The detected concentration in boiling-water-extraction solution is equal or greater than 0.02 mg/kg with 50 cm<sup>2</sup> tested areas . / 該溶液濃度 $\geq$ 0.02 mg/kg with 50 cm<sup>2</sup> (tested areas)

6. \*\* = Qualitative analysis (No Unit) 定性分析(無單位)
7. \*\*\*: 該物質是由"三丁基錫", "三苯基錫"之測試結果計算得知. 其MDL是針對"三丁基錫", "三苯基錫"之評估. (The substance was calculated by the test results of Tributyl Tin, Triphenyl Tin ).  
The MDL is evaluated for Tributyl Tin, Triphenyl Tin .
8. 聚氯乙稀(PVC):Negative = Undetectable 陰性(未偵測到); Positive = Detectable 陽性(已偵測到)
9. 石棉定性分析試驗範圍: <0.1%~100%, 石棉鑑定的判定基準是以檢出含有石棉纖維為『Positive』, 未檢出石棉纖維為『Negative』。 / Testing range of asbestos qualitative analysis is from less than 0.1% to 100%.  
The judgment criterion: asbestos fibers being found is shown as "Positive"; asbestos fibers not being found is shown as "Negative".
10. 石棉測試由SGS其他實驗室執行 (The Asbestos test was subcontracted to other SGS Laboratory. )
11. 聚氯乙稀測試由SGS其他實驗室執行 (The PVC test was subcontracted to other SGS Laboratory. )

### PFOS參考資訊(Reference Information) : 持久性有機污染物 POPs - (EU) 757/2010

PFOS濃度在物質或製備中不得超過0.001%(10ppm), 在半成品、成品或零部件中不得超過0.1%(1000ppm), 在紡織品或塗層材料中不得超過1 $\mu$ g/m<sup>2</sup>。(Outlawing PFOS as substances or preparations in concentrations above 0.001% (10ppm), in semi-finished products or articles or parts at a level above 0.1%(1000ppm), in textiles or other coated materials above 1 $\mu$ g/m<sup>2</sup>.)

## 測試報告 Test Report

號碼(No.) : KA/2014/C1451 日期(Date) : 2014/12/27 頁數(Page) : 13 of 27

金居開發股份有限公司  
CO-TECH DEVELOPMENT CORP.

64064 雲林縣斗六市科工八路56號

NO. 56, KOUKONG 8 ROAD, TOULIEU, YUN LIN, TAIWAN, R. O. C.

- 1) 根據以下的流程圖之條件，樣品已完全溶解。(六價鉻測試方法除外) / These samples were dissolved totally by pre-conditioning method according to below flow chart. (Cr<sup>6+</sup> test method excluded)
- 2) 測試人員：劉俊宏 / Name of the person who made measurement: Jony Liu
- 3) 測試負責人：張伯睿 / Name of the person in charge of measurement: Ray Chang

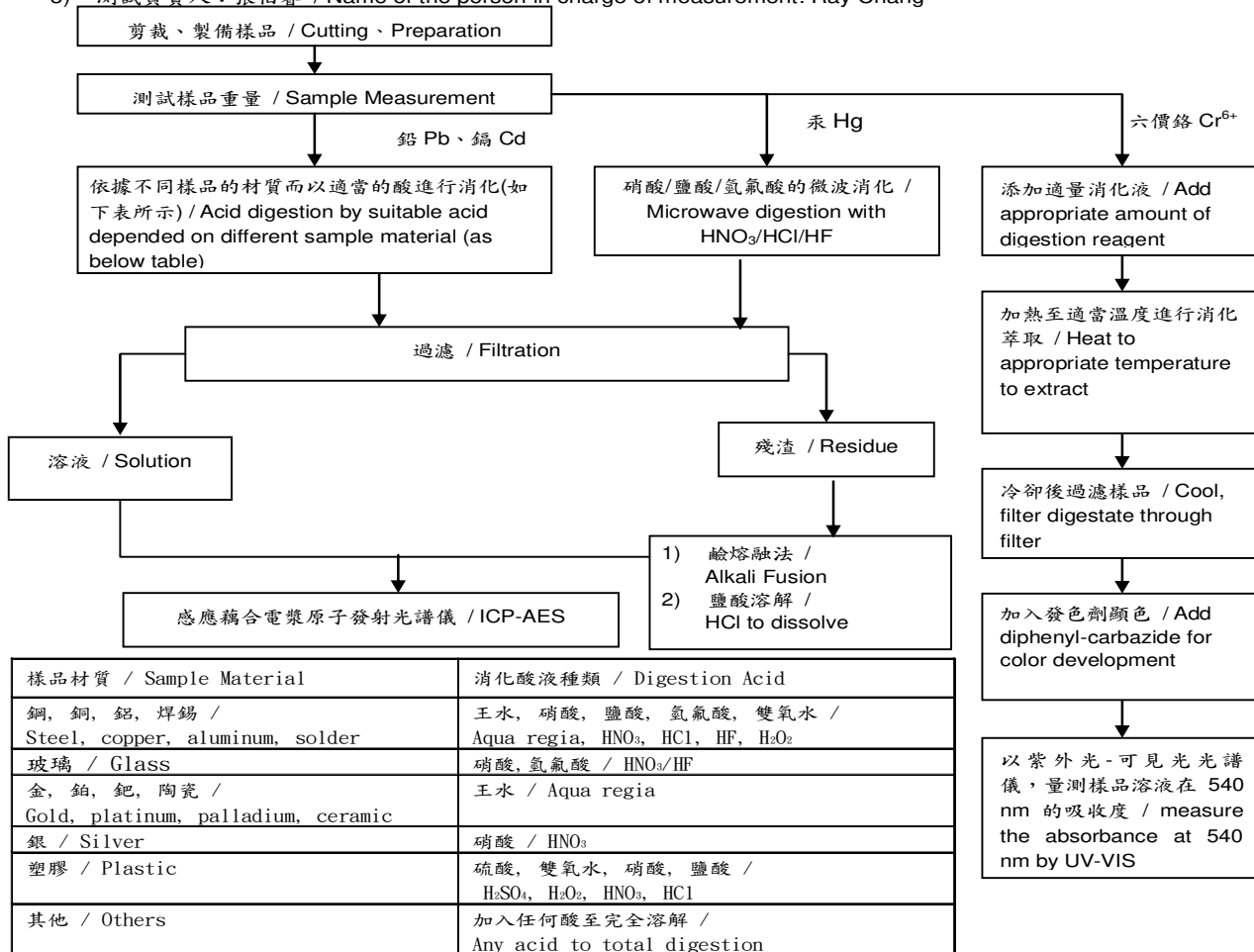

**Note\*\* :** (1) 針對非金屬材料加入鹼性消化液，加熱至 90~95°C 萃取。 / For non-metallic material, add alkaline digestion reagent and heat to 90~95°C.

(2) 針對金屬材料加入純水，加熱至沸騰萃取。 / For metallic material, add pure water and heat to boiling.

Unless otherwise stated the results shown in this test report refer only to the sample(s) tested. This test report cannot be reproduced, except in full, without prior written permission of the Company. 除非另有說明，此報告結果僅對測試之樣品負責。本報告未經本公司書面許可，不可部分複製。 This document is issued by the Company subject to its General Conditions of Service printed overleaf, available on request or accessible at [www.sgs.com/terms\\_and\\_conditions.htm](http://www.sgs.com/terms_and_conditions.htm) and, for electronic format documents, subject to Terms and Conditions for Electronic Documents at [www.sgs.com/terms\\_e-document.htm](http://www.sgs.com/terms_e-document.htm). Attention is drawn to the limitation of liability, indemnification and jurisdiction issues defined therein. Any holder of this document is advised that information contained hereon reflects the Company's findings at the time of its intervention only and within the limits of Client's instructions, if any. The Company's sole responsibility is to its Client and this document does not exonerate parties to a transaction from exercising all their rights and obligations under the transaction documents. This document cannot be reproduced except in full, without prior written approval of the Company. Any unauthorized alteration, forgery or falsification of the content or appearance of this document is unlawful and offenders may be prosecuted to the fullest extent of the law.

## 測試報告 Test Report

號碼(No.) : KA/2014/C1451 日期(Date) : 2014/12/27 頁數(Page) : 14 of 27

金居開發股份有限公司  
CO-TECH DEVELOPMENT CORP.  
64064雲林縣斗六市科工八路56號  
NO. 56, KOUKONG 8 ROAD, TOULIEU, YUN LIN, TAIWAN, R. O. C.

### 多溴聯苯/多溴聯苯醚 分析流程圖 / PBB/PBDE analytical FLOW CHART

- 1)測試人員：陳威錚 / Name of the person who made measurement: Dorothy Chen  
2)測試負責人：張伯睿 / Name of the person in charge of measurement: Ray Chang

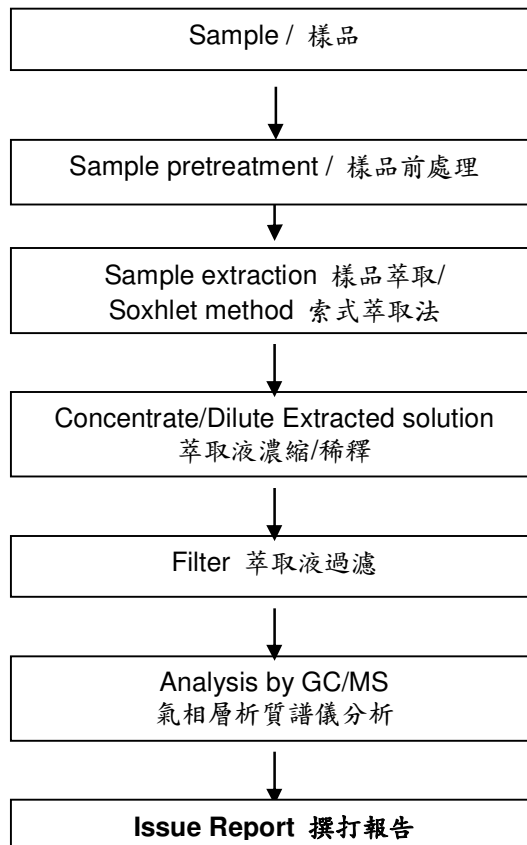

Unless otherwise stated the results shown in this test report refer only to the sample(s) tested. This test report cannot be reproduced, except in full, without prior written permission of the Company. 除非另有說明，此報告結果僅對測試之樣品負責。本報告未經本公司書面許可，不可部分複製。  
This document is issued by the Company subject to its General Conditions of Service printed overleaf, available on request or accessible at [www.sgs.com/terms\\_and\\_conditions.htm](http://www.sgs.com/terms_and_conditions.htm) and, for electronic format documents, subject to Terms and Conditions for Electronic Documents at [www.sgs.com/terms\\_e-document.htm](http://www.sgs.com/terms_e-document.htm). Attention is drawn to the limitation of liability, indemnification and jurisdiction issues defined therein. Any holder of this document is advised that information contained hereon reflects the Company's findings at the time of its intervention only and within the limits of Client's instructions, if any. The Company's sole responsibility is to its Client and this document does not exonerate parties to a transaction from exercising all their rights and obligations under the transaction documents. This document cannot be reproduced except in full, without prior written approval of the Company. Any unauthorized alteration, forgery or falsification of the content or appearance of this document is unlawful and offenders may be prosecuted to the fullest extent of the law.



# 測試報告 Test Report

號碼(No.) : KA/2014/C1451 日期(Date) : 2014/12/27 頁數(Page) : 15 of 27

金居開發股份有限公司  
CO-TECH DEVELOPMENT CORP.  
64064 雲林縣斗六市科工八路56號  
NO. 56, KOUKONG 8 ROAD, TOULIEU, YUN LIN, TAIWAN, R. O. C.

## 含氯阻燃劑分析流程 /

### Chlorinated Flame retardant analytical flow chart

- 1) 測試人員：陳威錚 / Name of the person who made measurement: Dorothy Chen
- 2) 測試負責人：張伯睿 / Name of the person in charge of measurement: Ray Chang

- 參考方法(Reference method): USEPA 3540
- 測試項目(Test Items): PCBs, CP, MCCP / 多氯聯苯, 氯化石蠟, 中鏈氯化石蠟

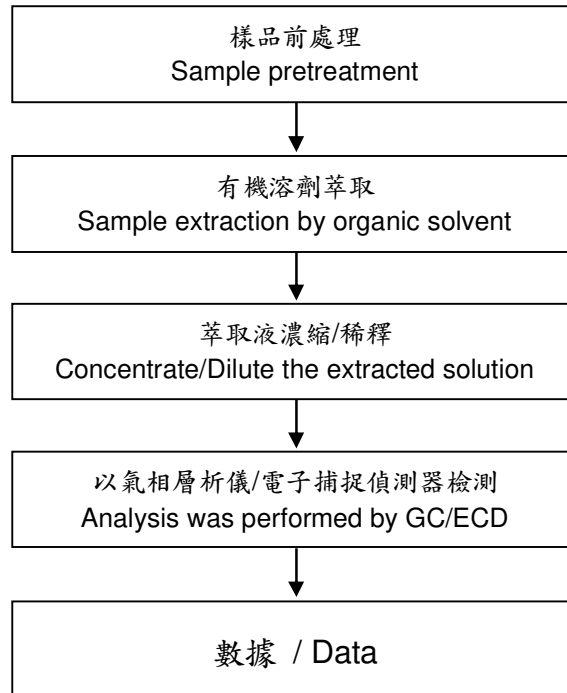

Unless otherwise stated the results shown in this test report refer only to the sample(s) tested. This test report cannot be reproduced, except in full, without prior written permission of the Company. 除非另有說明，此報告結果僅對測試之樣品負責。本報告未經本公司書面許可，不可部分複製。  
This document is issued by the Company subject to its General Conditions of Service printed overleaf, available on request or accessible at [www.sgs.com/terms\\_and\\_conditions.htm](http://www.sgs.com/terms_and_conditions.htm) and, for electronic format documents, subject to Terms and Conditions for Electronic Documents at [www.sgs.com/terms\\_e-document.htm](http://www.sgs.com/terms_e-document.htm). Attention is drawn to the limitation of liability, indemnification and jurisdiction issues defined therein. Any holder of this document is advised that information contained hereon reflects the Company's findings at the time of its intervention only and within the limits of Client's instructions, if any. The Company's sole responsibility is to its Client and this document does not exonerate parties to a transaction from exercising all their rights and obligations under the transaction documents. This document cannot be reproduced except in full, without prior written approval of the Company. Any unauthorized alteration, forgery or falsification of the content or appearance of this document is unlawful and offenders may be prosecuted to the fullest extent of the law.

# 測試報告 Test Report

號碼(No.) : KA/2014/C1451 日期(Date) : 2014/12/27 頁數(Page) : 16 of 27

金居開發股份有限公司  
CO-TECH DEVELOPMENT CORP.  
64064雲林縣斗六市科工八路56號  
NO. 56, KOUKONG 8 ROAD, TOULIEU, YUN LIN, TAIWAN, R. O. C.

## 含氯阻燃劑分析流程 /

### Chlorinated Flame retardant analytical flow chart

- 1) 測試人員：陳威錚 / Name of the person who made measurement: Dorothy Chen
- 2) 測試負責人：張伯睿 / Name of the person in charge of measurement: Ray Chang

- 參考方法(Reference method): US EPA 8270D, US EPA 3540
- 測試項目(Test Items): PCNs, PCTs, Mirex / 多氯奈, 多氯三聯苯, 滅蟻靈,

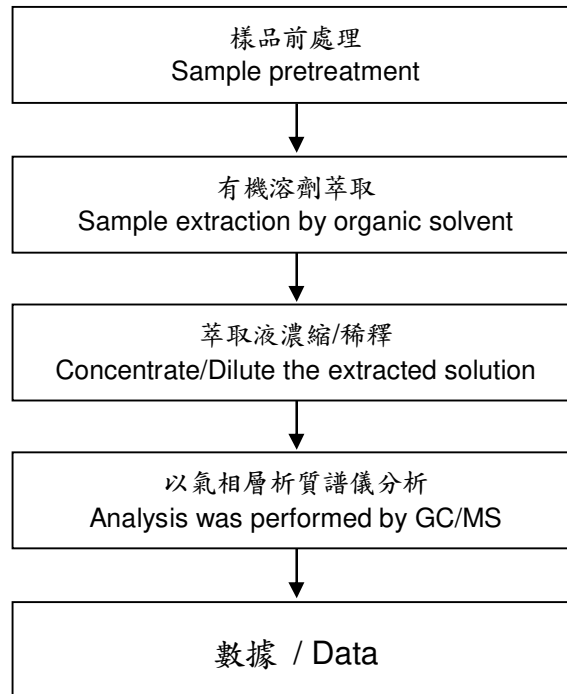

Unless otherwise stated the results shown in this test report refer only to the sample(s) tested. This test report cannot be reproduced, except in full, without prior written permission of the Company. 除非另有說明，此報告結果僅對測試之樣品負責。本報告未經本公司書面許可，不可部分複製。  
This document is issued by the Company subject to its General Conditions of Service printed overleaf, available on request or accessible at [www.sgs.com/terms\\_and\\_conditions.htm](http://www.sgs.com/terms_and_conditions.htm) and, for electronic format documents, subject to Terms and Conditions for Electronic Documents at [www.sgs.com/terms\\_e-document.htm](http://www.sgs.com/terms_e-document.htm). Attention is drawn to the limitation of liability, indemnification and jurisdiction issues defined therein. Any holder of this document is advised that information contained hereon reflects the Company's findings at the time of its intervention only and within the limits of Client's instructions, if any. The Company's sole responsibility is to its Client and this document does not exonerate parties to a transaction from exercising all their rights and obligations under the transaction documents. This document cannot be reproduced except in full, without prior written approval of the Company. Any unauthorized alteration, forgery or falsification of the content or appearance of this document is unlawful and offenders may be prosecuted to the fullest extent of the law.

## 測試報告 Test Report

號碼(No.) : KA/2014/C1451 日期(Date) : 2014/12/27 頁數(Page) : 17 of 27

金居開發股份有限公司  
CO-TECH DEVELOPMENT CORP.  
64064雲林縣斗六市科工八路56號  
NO. 56, KOUKONG 8 ROAD, TOULIEU, YUN LIN, TAIWAN, R. O. C.

### 四溴雙酚-A分析流程圖 / TBBP-A analytical flow chart

- 測試人員：黃璟璵 / Name of the person who made measurement: Ginny Huang
- 測試負責人：張伯睿 / Name of the person in charge of measurement: Ray Chang

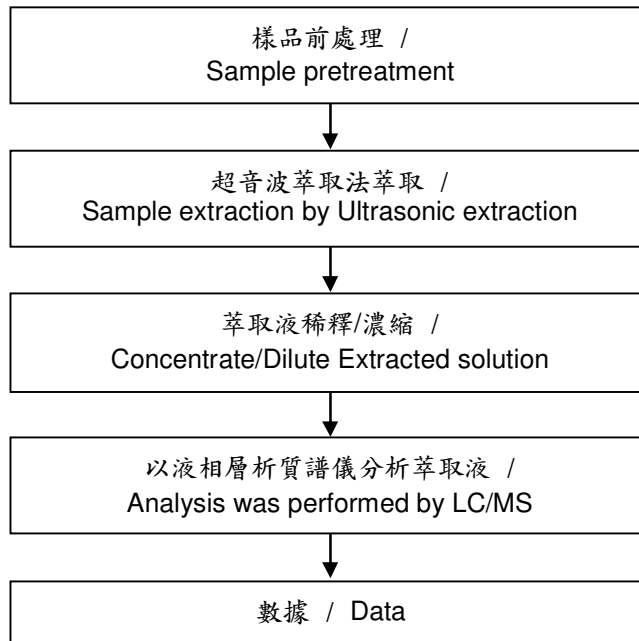

Unless otherwise stated the results shown in this test report refer only to the sample(s) tested. This test report cannot be reproduced, except in full, without prior written permission of the Company. 除非另有說明，此報告結果僅對測試之樣品負責。本報告未經本公司書面許可，不可部分複製。  
This document is issued by the Company subject to its General Conditions of Service printed overleaf, available on request or accessible at [www.sgs.com/terms\\_and\\_conditions.htm](http://www.sgs.com/terms_and_conditions.htm) and, for electronic format documents, subject to Terms and Conditions for Electronic Documents at [www.sgs.com/terms\\_e-document.htm](http://www.sgs.com/terms_e-document.htm). Attention is drawn to the limitation of liability, indemnification and jurisdiction issues defined therein. Any holder of this document is advised that information contained hereon reflects the Company's findings at the time of its intervention only and within the limits of Client's instructions, if any. The Company's sole responsibility is to its Client and this document does not exonerate parties to a transaction from exercising all their rights and obligations under the transaction documents. This document cannot be reproduced except in full, without prior written approval of the Company. Any unauthorized alteration, forgery or falsification of the content or appearance of this document is unlawful and offenders may be prosecuted to the fullest extent of the law.

## 測試報告 Test Report

號碼(No.) : KA/2014/C1451 日期(Date) : 2014/12/27 頁數(Page) : 18 of 27

金居開發股份有限公司  
CO-TECH DEVELOPMENT CORP.  
64064雲林縣斗六市科工八路56號  
NO. 56, KOUKONG 8 ROAD, TOULIEU, YUN LIN, TAIWAN, R. O. C.

### 六溴環十二烷分析流程圖 / HBCDD analytical flow chart

- 1) 測試人員：陳威錚/ Name of the person who made measurement: Dorothy Chen
- 2) 測試負責人：張伯睿/ Name of the person in charge of measurement: Ray Chang

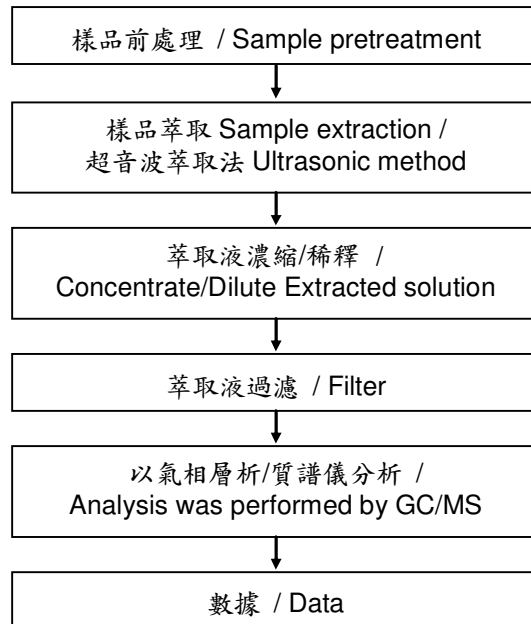

Unless otherwise stated the results shown in this test report refer only to the sample(s) tested. This test report cannot be reproduced, except in full, without prior written permission of the Company. 除非另有說明，此報告結果僅對測試之樣品負責。本報告未經本公司書面許可，不可部分複製。  
This document is issued by the Company subject to its General Conditions of Service printed overleaf, available on request or accessible at [www.sgs.com/terms\\_and\\_conditions.htm](http://www.sgs.com/terms_and_conditions.htm) and, for electronic format documents, subject to Terms and Conditions for Electronic Documents at [www.sgs.com/terms\\_e-document.htm](http://www.sgs.com/terms_e-document.htm). Attention is drawn to the limitation of liability, indemnification and jurisdiction issues defined therein. Any holder of this document is advised that information contained hereon reflects the Company's findings at the time of its intervention only and within the limits of Client's instructions, if any. The Company's sole responsibility is to its Client and this document does not exonerate parties to a transaction from exercising all their rights and obligations under the transaction documents. This document cannot be reproduced except in full, without prior written approval of the Company. Any unauthorized alteration, forgery or falsification of the content or appearance of this document is unlawful and offenders may be prosecuted to the fullest extent of the law.

## 測試報告 Test Report

號碼(No.) : KA/2014/C1451 日期(Date) : 2014/12/27 頁數(Page) : 19 of 27

金居開發股份有限公司  
CO-TECH DEVELOPMENT CORP.  
64064 雲林縣斗六市科工八路56號  
NO. 56, KOUKONG 8 ROAD, TOULIEU, YUN LIN, TAIWAN, R. O. C.

### 雙酚A分析流程圖 / Bisphenol A analytical flow chart

- 測試人員：黃璟璵 / Name of the person who made measurement: Ginny Huang
- 測試負責人：張伯睿 / Name of the person in charge of measurement: Ray Chang

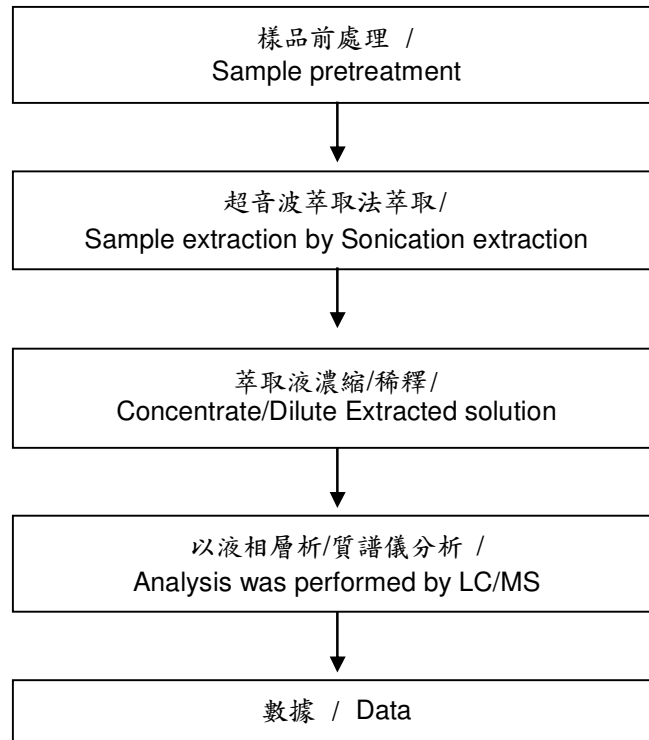

Unless otherwise stated the results shown in this test report refer only to the sample(s) tested. This test report cannot be reproduced, except in full, without prior written permission of the Company. 除非另有說明，此報告結果僅對測試之樣品負責。本報告未經本公司書面許可，不可部分複製。  
This document is issued by the Company subject to its General Conditions of Service printed overleaf, available on request or accessible at [www.sgs.com/terms\\_and\\_conditions.htm](http://www.sgs.com/terms_and_conditions.htm) and, for electronic format documents, subject to Terms and Conditions for Electronic Documents at [www.sgs.com/terms\\_e-document.htm](http://www.sgs.com/terms_e-document.htm). Attention is drawn to the limitation of liability, indemnification and jurisdiction issues defined therein. Any holder of this document is advised that information contained hereon reflects the Company's findings at the time of its intervention only and within the limits of Client's instructions, if any. The Company's sole responsibility is to its Client and this document does not exonerate parties to a transaction from exercising all their rights and obligations under the transaction documents. This document cannot be reproduced except in full, without prior written approval of the Company. Any unauthorized alteration, forgery or falsification of the content or appearance of this document is unlawful and offenders may be prosecuted to the fullest extent of the law.



## 測試報告 Test Report

號碼(No.) : KA/2014/C1451 日期(Date) : 2014/12/27 頁數(Page) : 20 of 27

金居開發股份有限公司  
CO-TECH DEVELOPMENT CORP.  
64064雲林縣斗六市科工八路56號  
NO. 56, KOUKONG 8 ROAD, TOULIEU, YUN LIN, TAIWAN, R. O. C.

### 富馬酸二甲酯分析流程圖 /

### Analytical flow chart of Dimethyl Fumarate content

- 1) 測試人員：陳威錚 / Name of the person who made measurement: Dorothy Chen
- 2) 測試負責人：張伯睿 / Name of the person in charge of measurement: Ray Chang

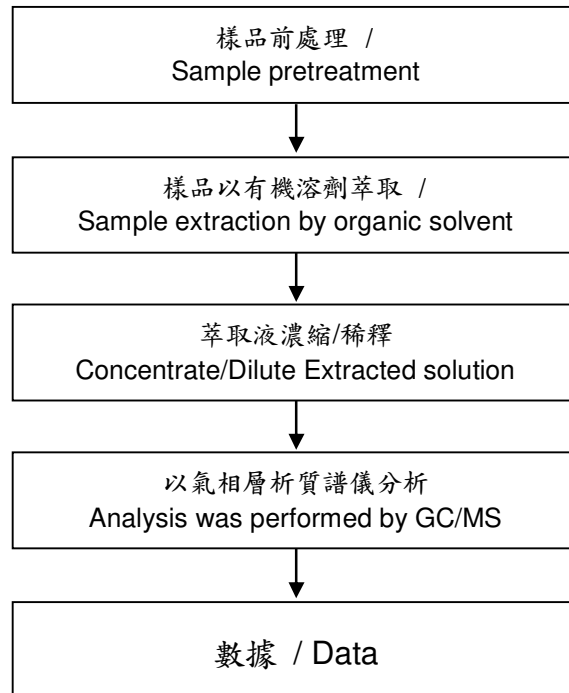

Unless otherwise stated the results shown in this test report refer only to the sample(s) tested. This test report cannot be reproduced, except in full, without prior written permission of the Company. 除非另有說明，此報告結果僅對測試之樣品負責。本報告未經本公司書面許可，不可部分複製。  
This document is issued by the Company subject to its General Conditions of Service printed overleaf, available on request or accessible at [www.sgs.com/terms\\_and\\_conditions.htm](http://www.sgs.com/terms_and_conditions.htm) and, for electronic format documents, subject to Terms and Conditions for Electronic Documents at [www.sgs.com/terms\\_e-document.htm](http://www.sgs.com/terms_e-document.htm). Attention is drawn to the limitation of liability, indemnification and jurisdiction issues defined therein. Any holder of this document is advised that information contained hereon reflects the Company's findings at the time of its intervention only and within the limits of Client's instructions, if any. The Company's sole responsibility is to its Client and this document does not exonerate parties to a transaction from exercising all their rights and obligations under the transaction documents. This document cannot be reproduced except in full, without prior written approval of the Company. Any unauthorized alteration, forgery or falsification of the content or appearance of this document is unlawful and offenders may be prosecuted to the fullest extent of the law.

## 測試報告 Test Report

號碼(No.) : KA/2014/C1451 日期(Date) : 2014/12/27 頁數(Page) : 21 of 27

金居開發股份有限公司  
CO-TECH DEVELOPMENT CORP.  
64064雲林縣斗六市科工八路56號  
NO. 56, KOUKONG 8 ROAD, TOULIEU, YUN LIN, TAIWAN, R. O. C.

### 聚氯乙稀物質判定分析流程圖 /

#### Analysis flow chart for determination of PVC in material

- 1) 測試人員：戴秀純 / Name of the person who made measurement: Hannah Tai  
2) 測試負責人：林立翔 / Name of the person in charge of measurement: Roger Lin

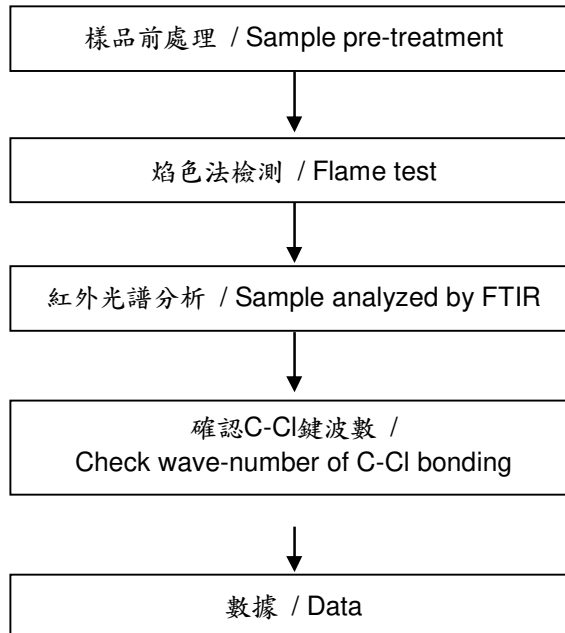

Unless otherwise stated the results shown in this test report refer only to the sample(s) tested. This test report cannot be reproduced, except in full, without prior written permission of the Company. 除非另有說明，此報告結果僅對測試之樣品負責。本報告未經本公司書面許可，不可部分複製。  
This document is issued by the Company subject to its General Conditions of Service printed overleaf, available on request or accessible at [www.sgs.com/terms\\_and\\_conditions.htm](http://www.sgs.com/terms_and_conditions.htm) and, for electronic format documents, subject to Terms and Conditions for Electronic Documents at [www.sgs.com/terms\\_e-document.htm](http://www.sgs.com/terms_e-document.htm). Attention is drawn to the limitation of liability, indemnification and jurisdiction issues defined therein. Any holder of this document is advised that information contained hereon reflects the Company's findings at the time of its intervention only and within the limits of Client's instructions, if any. The Company's sole responsibility is to its Client and this document does not exonerate parties to a transaction from exercising all their rights and obligations under the transaction documents. This document cannot be reproduced except in full, without prior written approval of the Company. Any unauthorized alteration, forgery or falsification of the content or appearance of this document is unlawful and offenders may be prosecuted to the fullest extent of the law.

# 測試報告 Test Report

號碼(No.) : KA/2014/C1451 日期(Date) : 2014/12/27 頁數(Page) : 22 of 27

金居開發股份有限公司  
CO-TECH DEVELOPMENT CORP.  
64064 雲林縣斗六市科工八路56號  
NO. 56, KOUKONG 8 ROAD, TOULIEU, YUN LIN, TAIWAN, R. O. C.

## 全氟辛酸(銨)/ 全氟辛烷磺酸分析流程圖 / Analytical flow chart of PFOA/PFOS content

- 1) 測試人員：黃璟璵 / Name of the person who made measurement: Ginny Huang  
2) 測試負責人：張伯睿 / Name of the person in charge of measurement: Ray Chang

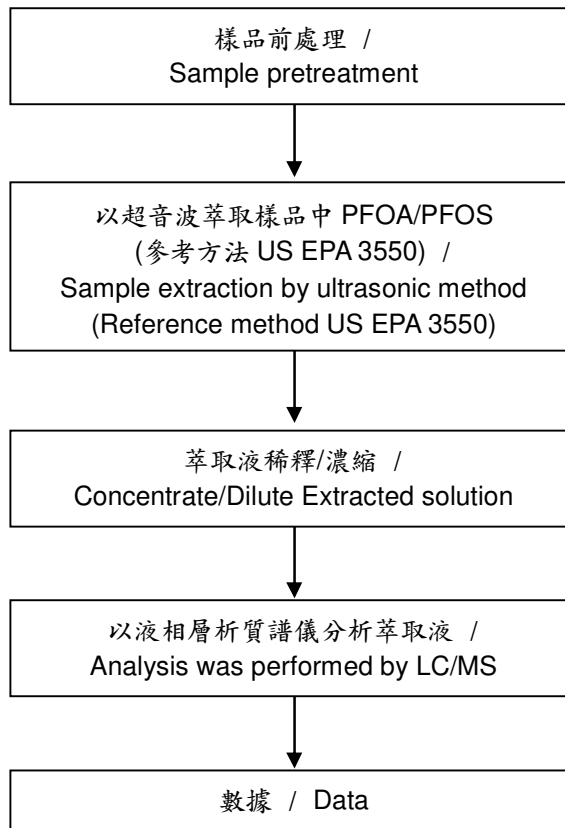

Unless otherwise stated the results shown in this test report refer only to the sample(s) tested. This test report cannot be reproduced, except in full, without prior written permission of the Company. 除非另有說明，此報告結果僅對測試之樣品負責。本報告未經本公司書面許可，不可部分複製。  
This document is issued by the Company subject to its General Conditions of Service printed overleaf, available on request or accessible at [www.sgs.com/terms\\_and\\_conditions.htm](http://www.sgs.com/terms_and_conditions.htm) and, for electronic format documents, subject to Terms and Conditions for Electronic Documents at [www.sgs.com/terms\\_e-document.htm](http://www.sgs.com/terms_e-document.htm). Attention is drawn to the limitation of liability, indemnification and jurisdiction issues defined therein. Any holder of this document is advised that information contained hereon reflects the Company's findings at the time of its intervention only and within the limits of Client's instructions, if any. The Company's sole responsibility is to its Client and this document does not exonerate parties to a transaction from exercising all their rights and obligations under the transaction documents. This document cannot be reproduced except in full, without prior written approval of the Company. Any unauthorized alteration, forgery or falsification of the content or appearance of this document is unlawful and offenders may be prosecuted to the fullest extent of the law.

## 測試報告 Test Report

號碼(No.) : KA/2014/C1451 日期(Date) : 2014/12/27 頁數(Page) : 23 of 27

金居開發股份有限公司  
CO-TECH DEVELOPMENT CORP.  
64064雲林縣斗六市科工八路56號  
NO. 56, KOUKONG 8 ROAD, TOULIEU, YUN LIN, TAIWAN, R. O. C.

### 有機錫分析流程圖 / Analytical flow chart of Organic-Tin content

- 1) 測試人員：陳威錚 / Name of the person who made measurement: Dorothy Chen
- 2) 測試負責人：張伯睿 / Name of the person in charge of measurement: Ray Chang

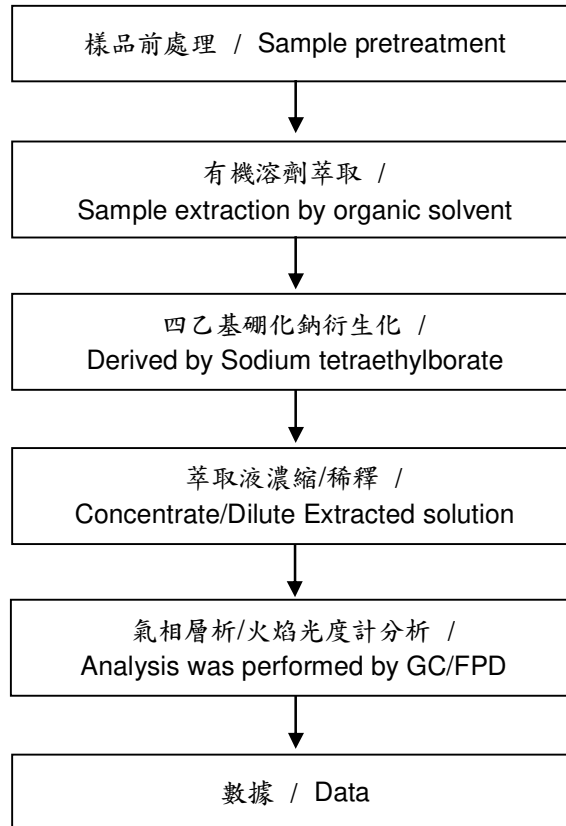

Unless otherwise stated the results shown in this test report refer only to the sample(s) tested. This test report cannot be reproduced, except in full, without prior written permission of the Company. 除非另有說明，此報告結果僅對測試之樣品負責。本報告未經本公司書面許可，不可部分複製。  
This document is issued by the Company subject to its General Conditions of Service printed overleaf, available on request or accessible at [www.sgs.com/terms\\_and\\_conditions.htm](http://www.sgs.com/terms_and_conditions.htm) and, for electronic format documents, subject to Terms and Conditions for Electronic Documents at [www.sgs.com/terms\\_e-document.htm](http://www.sgs.com/terms_e-document.htm). Attention is drawn to the limitation of liability, indemnification and jurisdiction issues defined therein. Any holder of this document is advised that information contained hereon reflects the Company's findings at the time of its intervention only and within the limits of Client's instructions, if any. The Company's sole responsibility is to its Client and this document does not exonerate parties to a transaction from exercising all their rights and obligations under the transaction documents. This document cannot be reproduced except in full, without prior written approval of the Company. Any unauthorized alteration, forgery or falsification of the content or appearance of this document is unlawful and offenders may be prosecuted to the fullest extent of the law.

## 測試報告 Test Report

號碼(No.) : KA/2014/C1451 日期(Date) : 2014/12/27 頁數(Page) : 24 of 27

金居開發股份有限公司  
CO-TECH DEVELOPMENT CORP.  
64064雲林縣斗六市科工八路56號  
NO. 56, KOUKONG 8 ROAD, TOULIEU, YUN LIN, TAIWAN, R. O. C.

### 鹵素分析流程圖 / Analytical flow chart of halogen content

- 1) 測試人員：洪秀真 / Name of the person who made measurement: Jean Hung
- 2) 測試負責人：張伯睿 / Name of the person in charge of measurement: Ray Chang

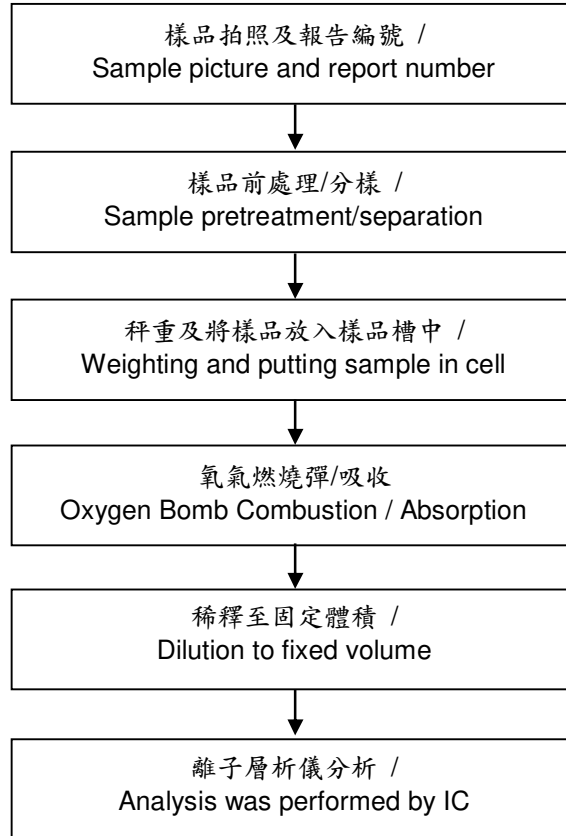

Unless otherwise stated the results shown in this test report refer only to the sample(s) tested. This test report cannot be reproduced, except in full, without prior written permission of the Company. 除非另有說明，此報告結果僅對測試之樣品負責。本報告未經本公司書面許可，不可部分複製。  
This document is issued by the Company subject to its General Conditions of Service printed overleaf, available on request or accessible at [www.sgs.com/terms\\_and\\_conditions.htm](http://www.sgs.com/terms_and_conditions.htm) and, for electronic format documents, subject to Terms and Conditions for Electronic Documents at [www.sgs.com/terms\\_e-document.htm](http://www.sgs.com/terms_e-document.htm). Attention is drawn to the limitation of liability, indemnification and jurisdiction issues defined therein. Any holder of this document is advised that information contained hereon reflects the Company's findings at the time of its intervention only and within the limits of Client's instructions, if any. The Company's sole responsibility is to its Client and this document does not exonerate parties to a transaction from exercising all their rights and obligations under the transaction documents. This document cannot be reproduced except in full, without prior written approval of the Company. Any unauthorized alteration, forgery or falsification of the content or appearance of this document is unlawful and offenders may be prosecuted to the fullest extent of the law.



## 測試報告 Test Report

號碼(No.) : KA/2014/C1451 日期(Date) : 2014/12/27 頁數(Page) : 25 of 27

金居開發股份有限公司  
CO-TECH DEVELOPMENT CORP.  
64064雲林縣斗六市科工八路56號  
NO. 56, KOUKONG 8 ROAD, TOULIEU, YUN LIN, TAIWAN, R. O. C.

### 石棉鑑定分析流程圖 / Analysis flow chart for determination of Asbestos

- 測試人員：高鍵忠 / Name of the person who made measurement: Victor Kao
- 測試負責人：魏明芬 / Name of the person in charge of measurement: Wendy Wei

#### 【參考方法(Reference method): EPA 600/R-93/116】

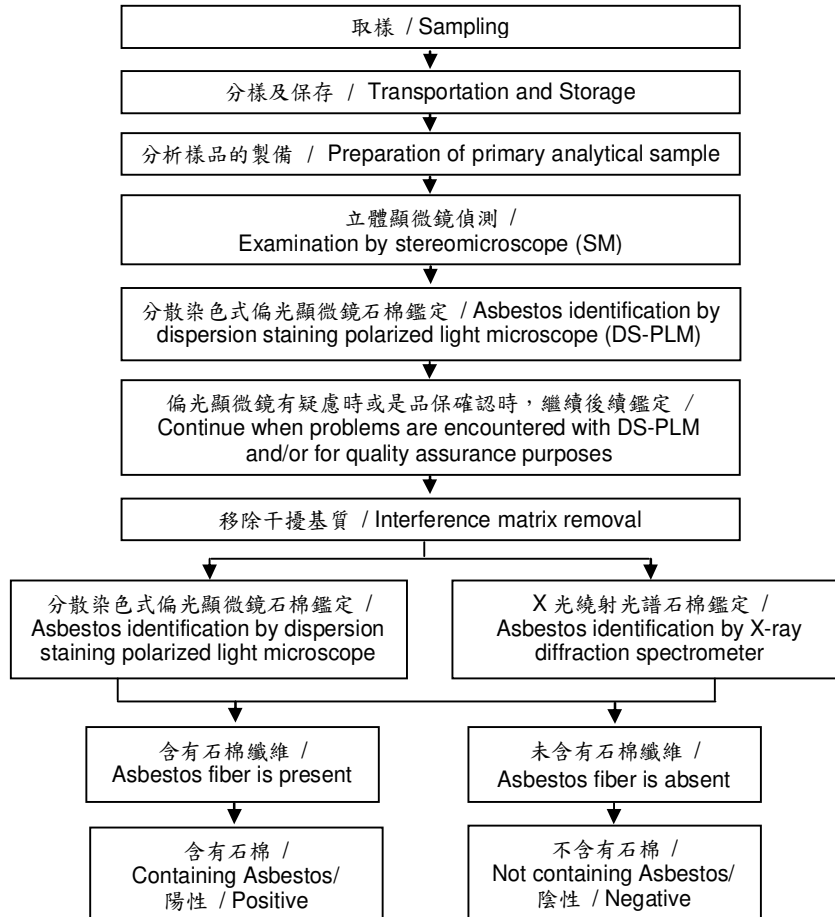

Unless otherwise stated the results shown in this test report refer only to the sample(s) tested. This test report cannot be reproduced, except in full, without prior written permission of the Company. 除非另有說明，此報告結果僅對測試之樣品負責。本報告未經本公司書面許可，不可部分複製。 This document is issued by the Company subject to its General Conditions of Service printed overleaf, available on request or accessible at [www.sgs.com/terms\\_and\\_conditions.htm](http://www.sgs.com/terms_and_conditions.htm) and, for electronic format documents, subject to Terms and Conditions for Electronic Documents at [www.sgs.com/terms\\_e-document.htm](http://www.sgs.com/terms_e-document.htm). Attention is drawn to the limitation of liability, indemnification and jurisdiction issues defined therein. Any holder of this document is advised that information contained hereon reflects the Company's findings at the time of its intervention only and within the limits of Client's instructions, if any. The Company's sole responsibility is to its Client and this document does not exonerate parties to a transaction from exercising all their rights and obligations under the transaction documents. This document cannot be reproduced except in full, without prior written approval of the Company. Any unauthorized alteration, forgery or falsification of the content or appearance of this document is unlawful and offenders may be prosecuted to the fullest extent of the law.

## 測試報告 Test Report

號碼(No.) : KA/2014/C1451 日期(Date) : 2014/12/27 頁數(Page) : 26 of 27

金居開發股份有限公司  
CO-TECH DEVELOPMENT CORP.  
64064雲林縣斗六市科工八路56號  
NO. 56, KOUKONG 8 ROAD, TOULIEU, YUN LIN, TAIWAN, R. O. C.

### 可塑劑分析流程圖 / Analytical flow chart of phthalate content

- 1) 測試人員：陳威錚 / Name of the person who made measurement: Dorothy Chen
- 2) 測試負責人：張伯睿 / Name of the person in charge of measurement: Ray Chang

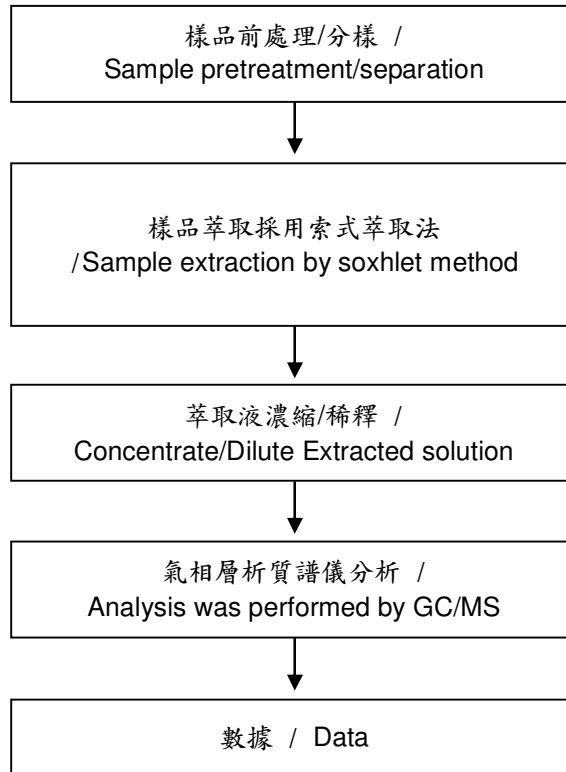

Unless otherwise stated the results shown in this test report refer only to the sample(s) tested. This test report cannot be reproduced, except in full, without prior written permission of the Company. 除非另有說明，此報告結果僅對測試之樣品負責。本報告未經本公司書面許可，不可部分複製。  
This document is issued by the Company subject to its General Conditions of Service printed overleaf, available on request or accessible at [www.sgs.com/terms\\_and\\_conditions.htm](http://www.sgs.com/terms_and_conditions.htm) and, for electronic format documents, subject to Terms and Conditions for Electronic Documents at [www.sgs.com/terms\\_e-document.htm](http://www.sgs.com/terms_e-document.htm). Attention is drawn to the limitation of liability, indemnification and jurisdiction issues defined therein. Any holder of this document is advised that information contained hereon reflects the Company's findings at the time of its intervention only and within the limits of Client's instructions, if any. The Company's sole responsibility is to its Client and this document does not exonerate parties to a transaction from exercising all their rights and obligations under the transaction documents. This document cannot be reproduced except in full, without prior written approval of the Company. Any unauthorized alteration, forgery or falsification of the content or appearance of this document is unlawful and offenders may be prosecuted to the fullest extent of the law.

## 測試報告 Test Report

號碼(No.) : KA/2014/C1451 日期(Date) : 2014/12/27 頁數(Page) : 27 of 27

金居開發股份有限公司  
CO-TECH DEVELOPMENT CORP.  
64064雲林縣斗六市科工八路56號  
NO. 56, KOUKONG 8 ROAD, TOULIEU, YUN LIN, TAIWAN, R. O. C.

\* 照片中如有箭頭標示，則表示為實際檢測之樣品/部位。\*  
(The tested sample / part is marked by an arrow if it's shown on the photo.)

### KA/2014/C1451

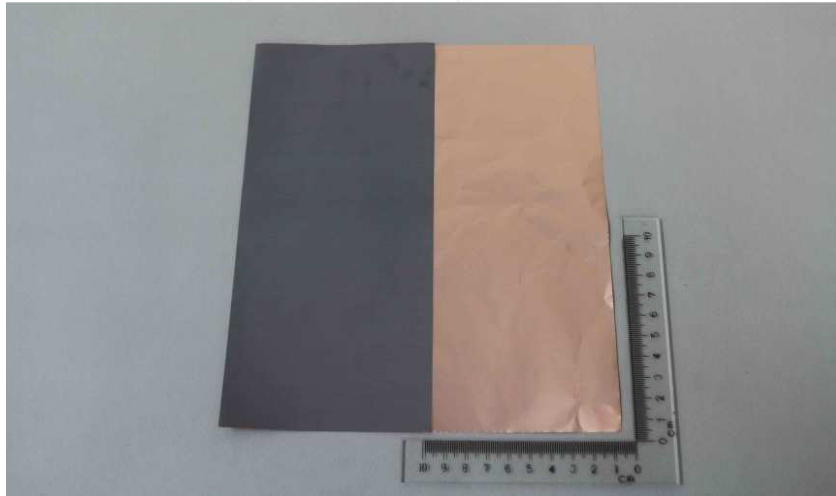

\*\* 報告結尾(End of Report) \*\*

## 測試報告

## Test Report

號碼(No.) : CE/2015/20347

日期(Date) : 2015/02/16

頁數(Page): 1 of 65



南亞塑膠工業股份有限公司(台灣) / NAN YA PLASTICS CORPORATION (TAIWAN)

(南亞電子材料(昆山)有限公司 / NAN YA ELECTRONIC MATERIALS (KUNSHAN) CORP., LTD)

(南亞電子材料(惠州)有限公司 / NAN YA ELECTRONIC MATERIALS (HUIZHOU) CORP., LTD)

台灣台北市敦化北路201號 / 201 TUNG HWA NORTH ROAD, TAIPEI, TAIWAN

(江蘇省昆山市市長江南路201號 / 201 CHANG JIANG ROAD(S) KUNSHAN ECONOMIC & TECHNICAL DEVELOPMENT ZONE, JIANG SU)

(廣東省惠州市博羅縣石灣鎮永石大道 / YONGSHI BOULEVARD SHIWAN TOWN BOLUO COUNTY HUIZHOU CITY GUANG DONG)

以下測試樣品係由申請廠商所提供及確認 (The following sample(s) was/were submitted and identified by/on behalf of the applicant as):

送樣廠商(Sample Submitted By) : 南亞塑膠工業股份有限公司 (NAN YA PLASTICS CORPORATION)  
樣品名稱(Sample Description) : PREPREG (UL E98983)  
樣品型號(Style/Item No.) : NP-140B  
買主/訂單號碼(Buyer/Order No.) : 10629B3  
收件日期(Sample Receiving Date) : 2015/02/02  
測試期間(Testing Period) : 2015/02/02 TO 2015/02/16

### 測試需求(Test Requested) :

- (1) 依據客戶要求, 參考RoHS 2011/65/EU Annex II 指令測試鎘、鉛、汞、六價鉻、多溴聯苯、多溴聯苯醚。(As specified by client, with reference to RoHS Directive 2011/65/EU Annex II to determine Cadmium, Lead, Mercury, Cr(VI), PBBs, PBDEs contents in the submitted sample.)
- (2) 依據客戶要求, 參考 WTO/TBT 通報 G/TBT/N/EU/256, 檢測 DBP, BBP, DEHP, DIBP。(As specified by client, with reference to G/TBT/N/EU/256 of WTO/TBT to test DBP, BBP, DEHP, DIBP.)
- (3) 依據客戶要求, 檢測 PAHs 及其他測項。 / As specified by client, to test PAHs and other item(s).

測試結果(Test Results) : 請見下一頁 (Please refer to next pages).

結論(Conclusion) : 請見下一頁 (Please refer to next pages).

  
  
Troy Chang / Manager - Tech  
Signed for and on behalf of  
SGS TAIWAN LTD.  
Chemical Laboratory - Taipei

## 測試報告

## Test Report

號碼(No.) : CE/2015/20347

日期(Date) : 2015/02/16

頁數(Page): 2 of 65

南亞塑膠工業股份有限公司(台灣) / NAN YA PLASTICS CORPORATION (TAIWAN)



(南亞電子材料(昆山)有限公司) / NAN YA ELECTRONIC MATERIALS (KUNSHAN) CORP., LTD)

(南亞電子材料(惠州)有限公司) / NAN YA ELECTRONIC MATERIALS (HUIZHOU) CORP., LTD)

台灣台北市敦化北路201號 / 201 TUNG HWA NORTH ROAD, TAIPEI, TAIWAN

(江蘇省昆山昆山市長江南路201號 / 201 CHANG JIANG ROAD(S) KUNSHAN ECONOMIC & TECHNICAL DEVELOPMENT ZONE, JIANG SU)

(廣東省惠州市博羅縣石灣鎮永石大道 / YONGSHI BOULEVARD SHIWAN TOWN BOLUO COUNTY HUIZHOU CITY GUANG DONG)

- 結論(Conclusion) :**
- (1) 根據客戶所提供的樣品，其鎘、鉛、汞、六價鉻、多溴聯苯、多溴聯苯醚的測試結果符合 RoHS 指令 2011/65/EU Annex II 之要求 (Based on the performed tests on submitted samples, the test result(s) of Cadmium, Lead, Mercury, Cr(VI), PBBs, PBDEs comply with the limits as set by RoHS Directive 2011/65/EU Annex II.)
  - (2) 根據客戶所提供的樣品，其 DBP, BBP, DEHP, DIBP 之測試結果符合 WTO/TBT 通報 G/TBT/N/EU/256 之限值要求 (Based on the performed tests on submitted samples, the test results of DBP, BBP, DEHP, DIBP comply with the limits as set by G/TBT/N/EU/256 of WTO/TBT.)
  - (3) 根據客戶所提供的樣品，其 PAHs 的測試結果符合德國 ZLS 的 ZEK 01.4-08 及其相關修訂文件中的第 1 類 PAHs 要求 (Base upon the performed tests by submitted samples, the test results of PAHs comply with the PAHs requirement according to (Category 1) of ZEK 01.4-08 of German ZLS and its amendments.)



## 測試報告

## Test Report

號碼(No.) : CE/2015/20347

日期(Date) : 2015/02/16

頁數(Page): 3 of 65



南亞塑膠工業股份有限公司(台灣) / NAN YA PLASTICS CORPORATION (TAIWAN)

(南亞電子材料(昆山)有限公司 / NAN YA ELECTRONIC MATERIALS (KUNSHAN) CORP., LTD)

(南亞電子材料(惠州)有限公司 / NAN YA ELECTRONIC MATERIALS (HUIZHOU) CORP., LTD)

台灣台北市敦化北路201號 / 201 TUNG HWA NORTH ROAD, TAIPEI, TAIWAN

(江蘇省昆山市長江南路201號 / 201 CHANG JIANG ROAD(S) KUNSHAN ECONOMIC & TECHNICAL DEVELOPMENT ZONE, JIANG SU)

(廣東省惠州市博羅縣石灣鎮永石大道 / YONGSHI BOULEVARD SHIWAN TOWN BOLUO COUNTY HUIZHOU CITY GUANG DONG)

### 測試結果(Test Results)

測試部位(PART NAME)No.1 : 黃色板子 (YELLOW SHEET)

測試項目 (Test Items)	單位 (Unit)	測試方法 (Method)	方法偵測 極限值 (MDL)	結果 (Result)	限值 (Limit)
				No.1	
鎘 / Cadmium (Cd)	mg/kg	參考IEC 62321-5: 2013方法, 以感應 耦合電漿原子發射光譜儀檢測. / With reference to IEC 62321-5: 2013 and performed by ICP-AES.	2	n.d.	100
鉛 / Lead (Pb)	mg/kg	參考IEC 62321-5: 2013方法, 以感應 耦合電漿原子發射光譜儀檢測. / With reference to IEC 62321-5: 2013 and performed by ICP-AES.	2	7	1000
汞 / Mercury (Hg)	mg/kg	參考IEC 62321-4: 2013方法, 以感應 耦合電漿原子發射光譜儀檢測. / With reference to IEC 62321-4: 2013 and performed by ICP-AES.	2	n.d.	1000
六價鉻 / Hexavalent Chromium Cr(VI)	mg/kg	參考IEC 62321: 2008方法, 以UV-VIS 檢測. / With reference to IEC 62321: 2008 and performed by UV- VIS.	2	n.d.	1000
鈹 / Beryllium (Be)	mg/kg	參考US EPA 3052方法, 以感應耦合電 漿原子發射光譜儀檢測. / With reference to US EPA Method 3052. Analysis was performed by ICP-AES.	2	n.d.	-
氧化鈹 / Beryllium oxide (BeO)***	mg/kg	參考US EPA 3052方法, 以感應耦合電 漿原子發射光譜儀檢測. / With reference to US EPA Method 3052. Analysis was performed by ICP- AES.***	-	n.d.	-

This document is issued by the Company subject to its General Conditions of Service printed overleaf, available on request or accessible at <http://www.sgs.com/en/Terms-and-Conditions.aspx> and, for electronic format documents, subject to Terms and Conditions for Electronic Documents at <http://www.sgs.com/en/Terms-and-Conditions/Termse-Document.aspx>. Attention is drawn to the limitation of liability, indemnification and jurisdiction issues defined therein. Any holder of this document is advised that information contained hereon reflects the Company's findings at the time of its intervention only and within the limits of client's instruction, if any. The Company's sole responsibility is to its Client and this document does not exonerate parties to a transaction from exercising all their rights and obligations under the transaction documents. This document cannot be reproduced, except in full, without prior written approval of the Company. Any unauthorized alteration, forgery or falsification of the content or appearance of this document is unlawful and offenders may be prosecuted to the fullest extent of the law. Unless otherwise stated the results shown in this test report refer only to the sample(s) tested.

# 測試報告

# Test Report

號碼(No.) : CE/2015/20347

日期(Date) : 2015/02/16

頁數(Page): 4 of 65



南亞塑膠工業股份有限公司(台灣) / NAN YA PLASTICS CORPORATION (TAIWAN)

(南亞電子材料(昆山)有限公司 / NAN YA ELECTRONIC MATERIALS (KUNSHAN) CORP., LTD)

(南亞電子材料(惠州)有限公司 / NAN YA ELECTRONIC MATERIALS (HUIZHOU) CORP., LTD)

台灣台北市敦化北路201號 / 201 TUNG HWA NORTH ROAD, TAIPEI, TAIWAN

(江蘇省昆山市長江南路201號 / 201 CHANG JIANG ROAD(S) KUNSHAN ECONOMIC & TECHNICAL DEVELOPMENT ZONE, JIANG SU)

(廣東省惠州市博羅縣石灣鎮永石大道 / YONGSHI BOULEVARD SHIWAN TOWN BOLUO COUNTY HUIZHOU CITY GUANG DONG)

測試項目 (Test Items)	單位 (Unit)	測試方法 (Method)	方法偵測 極限值 (MDL)	結果 (Result)	限值 (Limit)
				No.1	
砷 / Arsenic (As) (※2)	mg/kg	參考SGS內部方法RSTS-EE-SVHC-007, 以感應耦合電漿原子發射光譜儀檢測。 / SGS In-House method-RSTS-EE-SVHC-007. Analyzed by ICP-AES.	50	n.d.	-
五氧化二砷 / Diarsenic pentaoxide*** (CAS No.: 1303-28-2)	mg/kg	參考SGS內部方法RSTS-EE-SVHC-007, 以感應耦合電漿原子發射光譜儀檢測。 / SGS In-House method-RSTS-EE-SVHC-007. Analyzed by ICP-AES.***	-	n.d.	-
三氧化二砷 / Diarsenic trioxide*** (CAS No.: 1327-53-3)	mg/kg	參考SGS內部方法RSTS-EE-SVHC-007, 以感應耦合電漿原子發射光譜儀檢測。 / SGS In-House method-RSTS-EE-SVHC-007. Analyzed by ICP-AES.***	-	n.d.	-
銻 / Antimony (Sb)	mg/kg	參考US EPA 3052方法, 以感應耦合電漿原子發射光譜儀檢測。 / With reference to US EPA Method 3052. Analysis was performed by ICP-AES.	2	n.d.	-
硼 / Boron (B) (※2)	mg/kg	參考SGS內部方法RSTS-EE-SVHC-007, 以感應耦合電漿原子發射光譜儀檢測。 / SGS In-House method-RSTS-EE-SVHC-007. Analyzed by ICP-AES.	50	n.d.	-
硼酸 / Boric acid*** (CAS No.: 10043-35-3; 11113-50-1)	mg/kg	參考SGS內部方法RSTS-EE-SVHC-007, 以感應耦合電漿原子發射光譜儀檢測。 / SGS In-House method-RSTS-EE-SVHC-007. Analyzed by ICP-AES.***	-	n.d.	-
無水四硼酸二鈉 / Disodium tetraborate, anhydrous*** (CAS No.: 1303-96-4, 1330-43-4, 12179-04-3)	mg/kg	參考SGS內部方法RSTS-EE-SVHC-007, 以感應耦合電漿原子發射光譜儀檢測。 / SGS In-House method-RSTS-EE-SVHC-007. Analyzed by ICP-AES.***	-	n.d.	-

This document is issued by the Company subject to its General Conditions of Service printed overleaf, available on request or accessible at <http://www.sgs.com/en/Terms-and-Conditions.aspx> and, for electronic format documents, subject to Terms and Conditions for Electronic Documents at <http://www.sgs.com/en/Terms-and-Conditions/Termse-Documents.aspx>. Attention is drawn to the limitation of liability, indemnification and jurisdiction issues defined therein. Any holder of this document is advised that information contained hereon reflects the Company's findings at the time of its intervention only and within the limits of client's instruction, if any. The Company's sole responsibility is to its Client and this document does not exonerate parties to a transaction from exercising all their rights and obligations under the transaction documents. This document cannot be reproduced, except in full, without prior written approval of the Company. Any unauthorized alteration, forgery or falsification of the content or appearance of this document is unlawful and offenders may be prosecuted to the fullest extent of the law. Unless otherwise stated the results shown in this test report refer only to the sample(s) tested.

# 測試報告

# Test Report

號碼(No.) : CE/2015/20347

日期(Date) : 2015/02/16

頁數(Page): 5 of 65



南亞塑膠工業股份有限公司(台灣) / NAN YA PLASTICS CORPORATION (TAIWAN)  
 (南亞電子材料(昆山)有限公司 / NAN YA ELECTRONIC MATERIALS (KUNSHAN) CORP., LTD)  
 (南亞電子材料(惠州)有限公司 / NAN YA ELECTRONIC MATERIALS (HUIZHOU) CORP., LTD)  
 台灣台北市敦化北路201號 / 201 TUNG HWA NORTH ROAD, TAIPEI, TAIWAN  
 (江蘇省昆山市長江南路201號 / 201 CHANG JIANG ROAD(S) KUNSHAN ECONOMIC & TECHNICAL DEVELOPMENT ZONE, JIANG SU)  
 (廣東省惠州市博羅縣石灣鎮永石大道 / YONGSHI BOULEVARD SHIWAN TOWN BOLUO COUNTY HUIZHOU CITY GUANG DONG)

測試項目 (Test Items)	單位 (Unit)	測試方法 (Method)	方法偵測 極限值 (MDL)	結果 (Result)	限值 (Limit)
				No.1	
水合硼酸鈉 / Tetraboron disodium heptaoxide, hydrate (CAS No.: 12267-73-1) (*2)	mg/kg	參考SGS內部方法RSTS-EE-SVHC-007, 以感應耦合電漿原子發射光譜儀檢測. / SGS In-House method-RSTS-EE-SVHC-007. Analyzed by ICP-AES.	-	n.d.	-
四溴雙酚-A / Tetrabromobisphenol A (TBBP-A) (CAS No.: 79-94-7)	mg/kg	參考Global SOP RSTS-E&E-121方法, 以液相層析/質譜儀分析. / With reference to Global SOP RSTS-E&E-121. Analysis was performed by LC/MS.	10	n.d.	-
雙酚 A / Bisphenol A (CAS No.: 80-05-7)	mg/kg	參考RSTS-HL-229-1方法, 以超高效能液相層析串聯質譜儀檢測. / With reference to RSTS-HL-229-1 method. Analysis was performed by UPLC-MSMS.	1	n.d.	-
全氟辛烷磺酸 / Perfluorooctane sulfonates (PFOS-Acid, Metal Salt, Amide)	mg/kg	參考US EPA 3550C: 2007方法, 以液相層析/質譜儀檢測. / With reference to US EPA 3550C: 2007. Analysis was performed by LC/MS.	10	n.d.	-
全氟辛酸 / PFOA (CAS No.: 335-67-1)	mg/kg	參考US EPA 3550C: 2007方法, 以液相層析/質譜儀檢測. / With reference to US EPA 3550C: 2007. Analysis was performed by LC/MS.	10	n.d.	-
2-(3', 5'-二叔丁基-2'-羥基苯基)苯並三氮唑 / 2-(3,5-di-tert-butyl-2-hydroxyphenyl)-2H-benzotriazole (CAS No.: 3846-71-7)	mg/kg	參考US EPA 3540C方法, 以氣相層析/質譜儀檢測之. / With reference to US EPA 3540C method. Analysis was performed by GC/MS.	5	n.d.	-
二氯化鈷 / Cobalt dichloride (CAS No.: 7646-79-9)	mg/kg	參考SGS內部方法RSTS-EE-SVHC-007, 以感應耦合電漿原子發射光譜儀檢測. / SGS In-House method-RSTS-EE-SVHC-007. Analyzed by ICP-AES.	50	n.d.	-

This document is issued by the Company subject to its General Conditions of Service printed overleaf, available on request or accessible at <http://www.sgs.com/en/Terms-and-Conditions.aspx> and, for electronic format documents, subject to Terms and Conditions for Electronic Documents at <http://www.sgs.com/en/Terms-and-Conditions/Termse-Documents.aspx>. Attention is drawn to the limitation of liability, indemnification and jurisdiction issues defined therein. Any holder of this document is advised that information contained hereon reflects the Company's findings at the time of its intervention only and within the limits of client's instruction, if any. The Company's sole responsibility is to its Client and this document does not exonerate parties to a transaction from exercising all their rights and obligations under the transaction documents. This document cannot be reproduced, except in full, without prior written approval of the Company. Any unauthorized alteration, forgery or falsification of the content or appearance of this document is unlawful and offenders may be prosecuted to the fullest extent of the law. Unless otherwise stated the results shown in this test report refer only to the sample(s) tested.

# 測試報告

# Test Report

號碼(No.) : CE/2015/20347

日期(Date) : 2015/02/16

頁數(Page): 6 of 65



南亞塑膠工業股份有限公司(台灣) / NAN YA PLASTICS CORPORATION (TAIWAN)

(南亞電子材料(昆山)有限公司 / NAN YA ELECTRONIC MATERIALS (KUNSHAN) CORP., LTD)

(南亞電子材料(惠州)有限公司 / NAN YA ELECTRONIC MATERIALS (HUIZHOU) CORP., LTD)

台灣台北市敦化北路201號 / 201 TUNG HWA NORTH ROAD, TAIPEI, TAIWAN

(江蘇省昆山市長江南路201號 / 201 CHANG JIANG ROAD(S) KUNSHAN ECONOMIC & TECHNICAL DEVELOPMENT ZONE, JIANG SU)

(廣東省惠州市博羅縣石灣鎮永石大道 / YONGSHI BOULEVARD SHIWAN TOWN BOLUO COUNTY HUIZHOU CITY GUANG DONG)

測試項目 (Test Items)	單位 (Unit)	測試方法 (Method)	方法偵測 極限值 (MDL)	結果 (Result)	限值 (Limit)
				No.1	
多氯聯苯 / Polychlorinated Biphenyls (PCBs) (CAS No.: 1336-36-3)	mg/kg	參考US EPA 3540C方法, 以氣相層析/質譜儀檢測. / With reference to US EPA 3540C method. Analysis was performed by GC/MS.	0.5	n.d.	-
多氯萘 / Polychlorinated Naphthalene (PCNs)	mg/kg	參考US EPA 3540C方法, 以氣相層析/質譜儀檢測. / With reference to US EPA 3540C method. Analysis was performed by GC/MS.	5	n.d.	-
多氯三聯苯 / Polychlorinated Terphenyls (PCTs)	mg/kg	參考US EPA 3540C方法, 以氣相層析/質譜儀檢測. / With reference to US EPA 3540C method. Analysis was performed by GC/MS.	0.5	n.d.	-
短鏈氯化石蠟 / Alkanes, C10-13, chloro (Short Chain Chlorinated Paraffins) (CAS No.: 85535-84-8)	mg/kg	參考US EPA 3540C方法, 以氣相層析/質譜儀檢測. / With reference to US EPA 3540C method. Analysis was performed by GC/MS.	100	n.d.	-
甲醛 / Formaldehyde (CAS No.: 50-00-0)	mg/kg	參考ISO 17226-1(2008)方法, 以高效液相層析儀/二極體陣列偵測器檢測. / With reference to ISO 17226-1(2008). Analysis was performed by HPLC/DAD.	3	n.d.	-
聚氯乙稀 / PVC	**	以紅外光譜分析及焰色法檢測. / Analysis was performed by FTIR and FLAME Test.	-	Negative	-
六氟化硫 / Sulfur Hexafluoride (SF6) (CAS No.: 2551-62-4)	mg/kg	參考US EPA 5021方法, 以氣相層析/質譜儀檢測. / With reference to US EPA 5021 method. Analysis was performed by GC/MS.	1	n.d.	-

This document is issued by the Company subject to its General Conditions of Service printed overleaf, available on request or accessible at <http://www.sgs.com/en/Terms-and-Conditions.aspx> and, for electronic format documents, subject to Terms and Conditions for Electronic Documents at <http://www.sgs.com/en/Terms-and-Conditions/Termse-Documents.aspx>. Attention is drawn to the limitation of liability, indemnification and jurisdiction issues defined therein. Any holder of this document is advised that information contained hereon reflects the Company's findings at the time of its intervention only and within the limits of client's instruction, if any. The Company's sole responsibility is to its Client and this document does not exonerate parties to a transaction from exercising all their rights and obligations under the transaction documents. This document cannot be reproduced, except in full, without prior written approval of the Company. Any unauthorized alteration, forgery or falsification of the content or appearance of this document is unlawful and offenders may be prosecuted to the fullest extent of the law. Unless otherwise stated the results shown in this test report refer only to the sample(s) tested.

# 測試報告

# Test Report

號碼(No.) : CE/2015/20347

日期(Date) : 2015/02/16

頁數(Page): 7 of 65



南亞塑膠工業股份有限公司(台灣) / NAN YA PLASTICS CORPORATION (TAIWAN)  
 (南亞電子材料(昆山)有限公司 / NAN YA ELECTRONIC MATERIALS (KUNSHAN) CORP., LTD)  
 (南亞電子材料(惠州)有限公司 / NAN YA ELECTRONIC MATERIALS (HUIZHOU) CORP., LTD)  
 台灣台北市敦化北路201號 / 201 TUNG HWA NORTH ROAD, TAIPEI, TAIWAN  
 (江蘇省昆山市長江南路201號 / 201 CHANG JIANG ROAD(S) KUNSHAN ECONOMIC & TECHNICAL DEVELOPMENT ZONE, JIANG SU)  
 (廣東省惠州市博羅縣石灣鎮永石大道 / YONGSHI BOULEVARD SHIWAN TOWN BOLUO COUNTY HUIZHOU CITY GUANG DONG)

測試項目 (Test Items)	單位 (Unit)	測試方法 (Method)	方法偵測 極限值 (MDL)	結果 (Result)	限值 (Limit)
				No.1	
富馬酸二甲酯 / Dimethyl Fumarate (CAS No.: 624-49-7)	mg/kg	參考US EPA 3550C方法, 以氣相層析/ 質譜儀檢測. / With reference to US EPA 3550C method. Analysis was performed by GC/MS.	0.1	n.d.	-
磷酸三(2-氯乙基)酯 / Tris (2- chloroethyl) phosphate (TCEP) (CAS No.: 115-96-8)	mg/kg	參考US EPA 3550C方法, 以氣相層析/ 質譜儀檢測. / With reference to US EPA 3550C method. Analysis was performed by GC/MS.	5	n.d.	-
磷酸三(1-氯-2-丙基)酯 / Tris(1- chloro-2-propyl) phosphate (TCPP) (CAS No.: 13674-84-5)	mg/kg	參考US EPA 3550C方法, 以氣相層析/ 質譜儀檢測. / With reference to US EPA 3550C method. Analysis was performed by GC/MS.	5	n.d.	-
磷酸三(1,3-二氯異丙基)酯 / Tris(1,3- dichloro-2-propyl)phosphate (TDCPP) (CAS No.: 13674-87-8)	mg/kg	參考US EPA 3550C方法, 以氣相層析/ 質譜儀檢測. / With reference to US EPA 3550C method. Analysis was performed by GC/MS.	5	n.d.	-
磷酸三(二甲苯)酯 / Trixylyl phosphate (TXP) (CAS No.: 25155-23- 1)	mg/kg	參考US EPA 3550C方法, 以氣相層析/ 質譜儀檢測. / With reference to US EPA 3550C method. Analysis was performed by GC/MS.	25	n.d.	-
六溴環十二烷及所有主要被辨別出的異構 物 / Hexabromocyclododecane (HBCDD) and all major diastereoisomers identified ( $\alpha$ - HBCDD, $\beta$ - HBCDD, $\gamma$ - HBCDD) (CAS No.: 25637-99-4 and 3194-55-6 (134237-51-7, 134237-50-6, 134237-52-8))	mg/kg	參考IEC 62321: 2008方法, 以氣相層 析/質譜儀檢測. / With reference to IEC 62321: 2008 method. Analysis was performed by GC/MS.	5	n.d.	-

This document is issued by the Company subject to its General Conditions of Service printed overleaf, available on request or accessible at <http://www.sgs.com/en/Terms-and-Conditions.aspx> and, for electronic format documents, subject to Terms and Conditions for Electronic Documents at <http://www.sgs.com/en/Terms-and-Conditions/Termse-Document.aspx>. Attention is drawn to the limitation of liability, indemnification and jurisdiction issues defined therein. Any holder of this document is advised that information contained hereon reflects the Company's findings at the time of its intervention only and within the limits of client's instruction, if any. The Company's sole responsibility is to its Client and this document does not exonerate parties to a transaction from exercising all their rights and obligations under the transaction documents. This document cannot be reproduced, except in full, without prior written approval of the Company. Any unauthorized alteration, forgery or falsification of the content or appearance of this document is unlawful and offenders may be prosecuted to the fullest extent of the law. Unless otherwise stated the results shown in this test report refer only to the sample(s) tested.



## 測試報告

## Test Report

號碼(No.) : CE/2015/20347

日期(Date) : 2015/02/16

頁數(Page): 8 of 65

南亞塑膠工業股份有限公司(台灣) / NAN YA PLASTICS CORPORATION (TAIWAN)

(南亞電子材料(昆山)有限公司 / NAN YA ELECTRONIC MATERIALS (KUNSHAN) CORP., LTD)

(南亞電子材料(惠州)有限公司 / NAN YA ELECTRONIC MATERIALS (HUIZHOU) CORP., LTD)

台灣台北市敦化北路201號 / 201 TUNG HWA NORTH ROAD, TAIPEI, TAIWAN

(江蘇省昆山市市長江南路201號 / 201 CHANG JIANG ROAD(S) KUNSHAN ECONOMIC & TECHNICAL DEVELOPMENT ZONE, JIANG SU)

(廣東省惠州市博羅縣石灣鎮永石大道 / YONGSHI BOULEVARD SHIWAN TOWN BOLUO COUNTY HUIZHOU CITY GUANG DONG)



測試項目 (Test Items)	單位 (Unit)	測試方法 (Method)	方法偵測 極限值 (MDL)	結果 (Result)	限值 (Limit)
				No.1	
對特辛基苯酚 / 辛基酚 / 4-(1,1,3,3-tetramethylbutyl) phenol, (4-tert-Octylphenol) (CAS No.: 140-66-9)	mg/kg	參考US EPA 3550C方法, 以液相層析/質譜儀檢測. / With reference to US EPA 3550C method. Analysis was performed by LC/MS.	10	n.d.	-
双(2-甲氧基乙基)醚 / Bis(2-methoxyethyl) ether (CAS No.: 111-96-6)	mg/kg	參考US EPA 3550C方法, 以氣相層析/質譜儀檢測. / With reference to US EPA 3550C method. Analysis was performed by GC/MS.	10	n.d.	-
N,N-二甲基乙醯胺 / N,N-dimethylacetamide (DMAC) (CAS No.: 127-19-5)	mg/kg	參考US EPA 3550C方法, 以氣相層析/質譜儀檢測. / With reference to US EPA 3550C method. Analysis was performed by GC/MS.	10	n.d.	-
鄰苯二甲酸二(2-乙基己基)酯 / DEHP (Di-(2-ethylhexyl) phthalate) (CAS No.: 117-81-7)	mg/kg	參考IEC 62321-8 (111/321/CD), 以氣相層析儀/質譜儀檢測之. / With reference to IEC 62321-8 (111/321/CD). Analysis was performed by GC/MS.	50	n.d.	1000
鄰苯二甲酸二丁酯 / DBP (Dibutyl phthalate) (CAS No.: 84-74-2)	mg/kg		50	n.d.	1000
鄰苯二甲酸丁苄甲酯 / BBP (Butyl Benzyl phthalate) (CAS No.: 85-68-7)	mg/kg		50	n.d.	1000
鄰苯二甲酸二異丁酯 / DIBP (Di-isobutyl phthalate) (CAS No.: 84-69-5)	mg/kg		50	n.d.	1000
鄰苯二甲酸二異壬酯 / DINP (Di-isononyl phthalate) (CAS No.: 28553-12-0; 68515-48-0)	mg/kg		50	n.d.	-
鄰苯二甲酸二異癸酯 / DIDP (Di-isodecyl phthalate) (CAS No.: 26761-40-0; 68515-49-1)	mg/kg		50	n.d.	-
鄰苯二甲酸二正辛酯 / DNOP (Di-n-octyl phthalate) (CAS No.: 117-84-0)	mg/kg		50	n.d.	-

This document is issued by the Company subject to its General Conditions of Service printed overleaf, available on request or accessible at <http://www.sgs.com/en/Terms-and-Conditions.aspx> and, for electronic format documents, subject to Terms and Conditions for Electronic Documents at <http://www.sgs.com/en/Terms-and-Conditions/Termse-Document.aspx>. Attention is drawn to the limitation of liability, indemnification and jurisdiction issues defined therein. Any holder of this document is advised that information contained hereon reflects the Company's findings at the time of its intervention only and within the limits of client's instruction, if any. The Company's sole responsibility is to its Client and this document does not exonerate parties to a transaction from exercising all their rights and obligations under the transaction documents. This document cannot be reproduced, except in full, without prior written approval of the Company. Any unauthorized alteration, forgery or falsification of the content or appearance of this document is unlawful and offenders may be prosecuted to the fullest extent of the law. Unless otherwise stated the results shown in this test report refer only to the sample(s) tested.

# 測試報告

# Test Report

號碼(No.) : CE/2015/20347

日期(Date) : 2015/02/16

頁數(Page): 9 of 65



南亞塑膠工業股份有限公司(台灣) / NAN YA PLASTICS CORPORATION (TAIWAN)

(南亞電子材料(昆山)有限公司 / NAN YA ELECTRONIC MATERIALS (KUNSHAN) CORP., LTD)

(南亞電子材料(惠州)有限公司 / NAN YA ELECTRONIC MATERIALS (HUIZHOU) CORP., LTD)

台灣台北市敦化北路201號 / 201 TUNG HWA NORTH ROAD, TAIPEI, TAIWAN

(江蘇省昆山市市長江南路201號 / 201 CHANG JIANG ROAD(S) KUNSHAN ECONOMIC & TECHNICAL DEVELOPMENT ZONE, JIANG SU)

(廣東省惠州市博羅縣石灣鎮永石大道 / YONGSHI BOULEVARD SHIWAN TOWN BOLUO COUNTY HUIZHOU CITY GUANG DONG)

測試項目 (Test Items)	單位 (Unit)	測試方法 (Method)	方法偵測 極限值 (MDL)	結果 (Result)	限值 (Limit)
				No.1	
鄰苯二甲酸二己酯 / DNHP (Di-n-hexyl phthalate) (CAS No.: 84-75-3)	%	參考EN 14372, 以氣相層析/質譜儀檢測。 / With reference to EN 14372. Analysis was performed by GC/MS.	0.003	n.d.	-
鄰苯二甲酸二(C6-8支鏈與直鏈)烷基酯, 富C7 / DIHP (1,2-Benzenedicarboxylic acid, di-C6-8-branched alkyl esters, C7-rich) (CAS No.: 71888-89-6)	%	參考EN 14372, 以氣相層析/質譜儀檢測。 / With reference to EN 14372. Analysis was performed by GC/MS.	0.01	n.d.	-
鄰苯二甲酸二(C7-11支鏈與直鏈)烷基酯 / DHNUP (1,2-Benzenedicarboxylic acid, di-C7-11-branched and linear alkyl esters) (CAS No.: 68515-42-4)	%	參考EN 14372, 以氣相層析/質譜儀檢測。 / With reference to EN 14372. Analysis was performed by GC/MS.	0.01	n.d.	-
鄰苯二甲酸二(2-甲氧基乙基)酯 / DMPEP (Bis (2-methoxyethyl) phthalate) (CAS No.: 117-82-8)	%	參考EN 14372, 以氣相層析/質譜儀檢測。 / With reference to EN 14372. Analysis was performed by GC/MS.	0.003	n.d.	-
鄰苯二甲酸二異戊酯 / DIPP (DiisopentylPhthalate) (CAS No.: 605-50-5)	%	參考EN 14372, 以氣相層析/質譜儀檢測。 / With reference to EN 14372. Analysis was performed by GC/MS.	0.003	n.d.	-
支鏈和直鏈1,2-苯二羧二戊酯 / 1,2-Benzenedicarboxylic acid, dipentylester, branched and linear (CAS No.: 84777-06-0)	%	參考EN 14372, 以氣相層析/質譜儀檢測。 / With reference to EN 14372. Analysis was performed by GC/MS.	0.003	n.d.	-

This document is issued by the Company subject to its General Conditions of Service printed overleaf, available on request or accessible at <http://www.sgs.com/en/Terms-and-Conditions.aspx> and, for electronic format documents, subject to Terms and Conditions for Electronic Documents at <http://www.sgs.com/en/Terms-and-Conditions/Termse-Documents.aspx>. Attention is drawn to the limitation of liability, indemnification and jurisdiction issues defined therein. Any holder of this document is advised that information contained hereon reflects the Company's findings at the time of its intervention only and within the limits of client's instruction, if any. The Company's sole responsibility is to its Client and this document does not exonerate parties to a transaction from exercising all their rights and obligations under the transaction documents. This document cannot be reproduced, except in full, without prior written approval of the Company. Any unauthorized alteration, forgery or falsification of the content or appearance of this document is unlawful and offenders may be prosecuted to the fullest extent of the law. Unless otherwise stated the results shown in this test report refer only to the sample(s) tested.

## 測試報告

## Test Report

號碼(No.) : CE/2015/20347

日期(Date) : 2015/02/16

頁數(Page): 10 of 65



南亞塑膠工業股份有限公司(台灣) / NAN YA PLASTICS CORPORATION (TAIWAN)

(南亞電子材料(昆山)有限公司 / NAN YA ELECTRONIC MATERIALS (KUNSHAN) CORP., LTD)

(南亞電子材料(惠州)有限公司 / NAN YA ELECTRONIC MATERIALS (HUIZHOU) CORP., LTD)

台灣台北市敦化北路201號 / 201 TUNG HWA NORTH ROAD, TAIPEI, TAIWAN

(江蘇省昆山市市長江南路201號 / 201 CHANG JIANG ROAD(S) KUNSHAN ECONOMIC & TECHNICAL DEVELOPMENT ZONE, JIANG SU)

(廣東省惠州市博羅縣石灣鎮永石大道 / YONGSHI BOULEVARD SHIWAN TOWN BOLUO COUNTY HUIZHOU CITY GUANG DONG)

測試項目 (Test Items)	單位 (Unit)	測試方法 (Method)	方法偵測 極限值 (MDL)	結果 (Result)	限值 (Limit)
				No.1	
鄰苯二甲酸正戊基異戊基酯 / N-pentyl-isopentylphthalate	%	參考EN 14372, 以氣相層析/質譜儀檢測。 / With reference to EN 14372. Analysis was performed by GC/MS.	0.003	n.d.	-
鄰苯二甲酸二戊酯 / DPP (Di-pentyl phthalate) (CAS No.: 131-18-0)	%	參考EN 14372, 以氣相層析/質譜儀檢測。 / With reference to EN 14372. Analysis was performed by GC/MS.	0.003	n.d.	-
鄰苯二甲酸二正戊酯 / DNPP (Di-n-pentyl phthalate) (CAS No.: 131-18-0)	%	參考EN 14372, 以氣相層析/質譜儀檢測。 / With reference to EN 14372. Analysis was performed by GC/MS.	0.003	n.d.	-
乙二醇二甲醚 / Ethylene glycol dimethyl ether (EGDME) (CAS No.: 110-71-4)	mg/kg	參考US EPA 3550C方法, 以氣相層析/質譜儀檢測。 / With reference to US EPA 3550C method. Analysis was performed by GC/MS.	10	n.d.	-
過氯酸鹽 / Perchlorate (CAS No.: 14797-73-0)	mg/kg	以離子層析儀檢測。 / Analysis was performed by IC.	0.006	n.d.	-
溴甲烷 / Bromomethane (CAS No.: 74-83-9)	mg/kg	參考US EPA 5021方法, 以氣相層析/質譜儀檢測。 / With reference to US EPA 5021 method. Analysis was performed by GC/MS.	1	n.d.	-
<b>鹵素 / Halogen</b>					
鹵素(氯) / Halogen-Chlorine (Cl) (CAS No.: 22537-15-1)	mg/kg	參考BS EN 14582:2007, 以離子層析儀分析。 / With reference to BS EN 14582:2007. Analysis was performed by IC.	50	516	-
鹵素(溴) / Halogen-Bromine (Br) (CAS No.: 10097-32-2)			50	72600	-
鹵素(氟) / Halogen-Fluorine (F) (CAS No.: 14762-94-8)			50	1330	-
鹵素(碘) / Halogen-Iodine (I) (CAS No.: 14362-44-8)			50	n.d.	-

This document is issued by the Company subject to its General Conditions of Service printed overleaf, available on request or accessible at <http://www.sgs.com/en/Terms-and-Conditions.aspx> and, for electronic format documents, subject to Terms and Conditions for Electronic Documents at <http://www.sgs.com/en/Terms-and-Conditions/Termse-Documents.aspx>. Attention is drawn to the limitation of liability, indemnification and jurisdiction issues defined therein. Any holder of this document is advised that information contained hereon reflects the Company's findings at the time of its intervention only and within the limits of client's instruction, if any. The Company's sole responsibility is to its Client and this document does not exonerate parties to a transaction from exercising all their rights and obligations under the transaction documents. This document cannot be reproduced, except in full, without prior written approval of the Company. Any unauthorized alteration, forgery or falsification of the content or appearance of this document is unlawful and offenders may be prosecuted to the fullest extent of the law. Unless otherwise stated the results shown in this test report refer only to the sample(s) tested.

## 測試報告

## Test Report

號碼(No.) : CE/2015/20347

日期(Date) : 2015/02/16

頁數(Page): 11 of 65



南亞塑膠工業股份有限公司(台灣) / NAN YA PLASTICS CORPORATION (TAIWAN)

(南亞電子材料(昆山)有限公司 / NAN YA ELECTRONIC MATERIALS (KUNSHAN) CORP., LTD)

(南亞電子材料(惠州)有限公司 / NAN YA ELECTRONIC MATERIALS (HUIZHOU) CORP., LTD)

台灣台北市敦化北路201號 / 201 TUNG HWA NORTH ROAD, TAIPEI, TAIWAN

(江蘇省昆山市市長江南路201號 / 201 CHANG JIANG ROAD(S) KUNSHAN ECONOMIC & TECHNICAL DEVELOPMENT ZONE, JIANG SU)

(廣東省惠州市博羅縣石灣鎮永石大道 / YONGSHI BOULEVARD SHIWAN TOWN BOLUO COUNTY HUIZHOU CITY GUANG DONG)

測試項目 (Test Items)	單位 (Unit)	測試方法 (Method)	方法偵測 極限值 (MDL)	結果 (Result)	限值 (Limit)		
				No.1			
<b>多溴聯苯總和 / Sum of PBBs</b>	mg/kg	參考IEC 62321: 2008方法, 以氣相層析/質譜儀檢測. / With reference to IEC 62321: 2008 and performed by GC/MS.	-	n.d.	1000		
一溴聯苯 / Monobromobiphenyl			5	n.d.	-		
二溴聯苯 / Dibromobiphenyl			5	n.d.	-		
三溴聯苯 / Tribromobiphenyl			5	n.d.	-		
四溴聯苯 / Tetrabromobiphenyl			5	n.d.	-		
五溴聯苯 / Pentabromobiphenyl			5	n.d.	-		
六溴聯苯 / Hexabromobiphenyl			5	n.d.	-		
七溴聯苯 / Heptabromobiphenyl			5	n.d.	-		
八溴聯苯 / Octabromobiphenyl			5	n.d.	-		
九溴聯苯 / Nonabromobiphenyl			5	n.d.	-		
十溴聯苯 / Decabromobiphenyl			5	n.d.	-		
<b>多溴聯苯醚總和 / Sum of PBDEs</b>					-	n.d.	1000
一溴聯苯醚 / Monobromodiphenyl ether					5	n.d.	-
二溴聯苯醚 / Dibromodiphenyl ether					5	n.d.	-
三溴聯苯醚 / Tribromodiphenyl ether					5	n.d.	-
四溴聯苯醚 / Tetrabromodiphenyl ether					5	n.d.	-
五溴聯苯醚 / Pentabromodiphenyl ether					5	n.d.	-
六溴聯苯醚 / Hexabromodiphenyl ether					5	n.d.	-
七溴聯苯醚 / Heptabromodiphenyl ether					5	n.d.	-
八溴聯苯醚 / Octabromodiphenyl ether					5	n.d.	-
九溴聯苯醚 / Nonabromodiphenyl ether			5	n.d.	-		
十溴聯苯醚 / Decabromodiphenyl ether			5	n.d.	-		

This document is issued by the Company subject to its General Conditions of Service printed overleaf, available on request or accessible at <http://www.sgs.com/en/Terms-and-Conditions.aspx> and, for electronic format documents, subject to Terms and Conditions for Electronic Documents at <http://www.sgs.com/en/Terms-and-Conditions/Termse-Documents.aspx>. Attention is drawn to the limitation of liability, indemnification and jurisdiction issues defined therein. Any holder of this document is advised that information contained hereon reflects the Company's findings at the time of its intervention only and within the limits of client's instruction, if any. The Company's sole responsibility is to its Client and this document does not exonerate parties to a transaction from exercising all their rights and obligations under the transaction documents. This document cannot be reproduced, except in full, without prior written approval of the Company. Any unauthorized alteration, forgery or falsification of the content or appearance of this document is unlawful and offenders may be prosecuted to the fullest extent of the law. Unless otherwise stated the results shown in this test report refer only to the sample(s) tested.

## 測試報告

## Test Report

號碼(No.) : CE/2015/20347

日期(Date) : 2015/02/16

頁數(Page): 12 of 65



南亞塑膠工業股份有限公司(台灣) / NAN YA PLASTICS CORPORATION (TAIWAN)

(南亞電子材料(昆山)有限公司 / NAN YA ELECTRONIC MATERIALS (KUNSHAN) CORP., LTD)

(南亞電子材料(惠州)有限公司 / NAN YA ELECTRONIC MATERIALS (HUIZHOU) CORP., LTD)

台灣台北市敦化北路201號 / 201 TUNG HWA NORTH ROAD, TAIPEI, TAIWAN

(江蘇省昆山市市長江南路201號 / 201 CHANG JIANG ROAD(S) KUNSHAN ECONOMIC & TECHNICAL DEVELOPMENT ZONE, JIANG SU)

(廣東省惠州市博羅縣石灣鎮永石大道 / YONGSHI BOULEVARD SHIWAN TOWN BOLUO COUNTY HUIZHOU CITY GUANG DONG)

測試項目 (Test Items)	單位 (Unit)	測試方法 (Method)	方法偵測 極限值 (MDL)	結果 (Result)	限值 (Limit)
				No.1	
<b>有機錫 / Organic-tin compounds</b>					
三丁基錫 / Tributyl Tin (TBT)	mg/kg	參考ISO 17353方法, 以氣相層析儀/火焰光度偵測器檢測. / With reference to ISO 17353. Analysis was performed by GC/FPD.	0.03	n.d.	-
三苯基錫 / Triphenyl Tin (TphT)			0.03	n.d.	-
二丁基錫 / Dibutyl Tin (DBT)			0.03	n.d.	-
二辛基錫 / Dioctyl Tin (DOT)			0.03	n.d.	-
三丁基錫氧化物 / Tributyl Tin Oxide (TBTO)***(CAS No.: 56-35-9)			-	n.d.	-
<b>偶氮 (AZO)</b>					
1): 4-氨基二苯 / 4-AMINODIPHENYL (CAS No.: 92-67-1)	mg/kg	參考LFGB 82.02-2方法, 以氣相層析/質譜儀檢測. / With reference to LFGB 82.02-2. Analysis was performed by GC/MS.	3	n.d.	-
2): 聯苯胺 / BENZIDINE (CAS No.: 92-87-5)	mg/kg	參考LFGB 82.02-2方法, 以氣相層析/質譜儀檢測. / With reference to LFGB 82.02-2. Analysis was performed by GC/MS.	3	n.d.	-
3): 4-氯鄰甲苯胺 / 4-CHLORO-O-TOLUIDINE (CAS No.: 95-69-2)	mg/kg	參考LFGB 82.02-2方法, 以氣相層析/質譜儀檢測. / With reference to LFGB 82.02-2. Analysis was performed by GC/MS.	3	n.d.	-
4): 2-萘胺 / 2-NAPHTHYLAMINE (CAS No.: 91-59-8)	mg/kg	參考LFGB 82.02-2方法, 以氣相層析/質譜儀檢測. / With reference to LFGB 82.02-2. Analysis was performed by GC/MS.	3	n.d.	-
5): 鄰氨基二甲苯偶氮 / O-AMINOAZOTOLUENE (CAS No.: 97-56-3)	mg/kg	參考LFGB 82.02-2方法, 以氣相層析/質譜儀檢測. / With reference to LFGB 82.02-2. Analysis was performed by GC/MS.	3	n.d.	-

This document is issued by the Company subject to its General Conditions of Service printed overleaf, available on request or accessible at <http://www.sgs.com/en/Terms-and-Conditions.aspx> and, for electronic format documents, subject to Terms and Conditions for Electronic Documents at <http://www.sgs.com/en/Terms-and-Conditions/Termse-Document.aspx>. Attention is drawn to the limitation of liability, indemnification and jurisdiction issues defined therein. Any holder of this document is advised that information contained hereon reflects the Company's findings at the time of its intervention only and within the limits of client's instruction, if any. The Company's sole responsibility is to its Client and this document does not exonerate parties to a transaction from exercising all their rights and obligations under the transaction documents. This document cannot be reproduced, except in full, without prior written approval of the Company. Any unauthorized alteration, forgery or falsification of the content or appearance of this document is unlawful and offenders may be prosecuted to the fullest extent of the law. Unless otherwise stated the results shown in this test report refer only to the sample(s) tested.



# 測試報告

號碼(No.) : CE/2015/20347

日期(Date) : 2015/02/16

頁數(Page): 13 of 65

# Test Report



南亞塑膠工業股份有限公司(台灣) / NAN YA PLASTICS CORPORATION (TAIWAN)

(南亞電子材料(昆山)有限公司 / NAN YA ELECTRONIC MATERIALS (KUNSHAN) CORP., LTD)

(南亞電子材料(惠州)有限公司 / NAN YA ELECTRONIC MATERIALS (HUIZHOU) CORP., LTD)

台灣台北市敦化北路201號 / 201 TUNG HWA NORTH ROAD, TAIPEI, TAIWAN

(江蘇省昆山市長江南路201號 / 201 CHANG JIANG ROAD(S) KUNSHAN ECONOMIC & TECHNICAL DEVELOPMENT ZONE, JIANG SU)

(廣東省惠州市博羅縣石灣鎮永石大道 / YONGSHI BOULEVARD SHIWAN TOWN BOLUO COUNTY HUIZHOU CITY GUANG DONG)

測試項目 (Test Items)	單位 (Unit)	測試方法 (Method)	方法偵測 極限值 (MDL)	結果 (Result)	限值 (Limit)
				No.1	
6): 對硝基鄰甲苯胺 / 2-AMINO-4-NITROTOLUENE (CAS No.: 99-55-8)	mg/kg	參考LFGB 82.02-2方法, 以氣相層析/質譜儀檢測. / With reference to LFGB 82.02-2. Analysis was performed by GC/MS.	3	n.d.	-
7): 對氯苯胺 / P-CHLOROANILINE (CAS No.: 106-47-8)	mg/kg	參考LFGB 82.02-2方法, 以氣相層析/質譜儀檢測. / With reference to LFGB 82.02-2. Analysis was performed by GC/MS.	3	n.d.	-
8): 4-甲氧基-間苯二胺 / 2,4-DIAMINOANISOLE (CAS No.: 615-05-4)	mg/kg	參考LFGB 82.02-2方法, 以氣相層析/質譜儀檢測. / With reference to LFGB 82.02-2. Analysis was performed by GC/MS.	3	n.d.	-
9): 4,4'-二氨基二苯甲烷 / 4,4'-DIAMINODIPHENYLMETHANE (CAS No.: 101-77-9)	mg/kg	參考LFGB 82.02-2方法, 以氣相層析/質譜儀檢測. / With reference to LFGB 82.02-2. Analysis was performed by GC/MS.	3	n.d.	-
10): 3,3'-二氯聯苯胺 / 3,3'-DICHLOROBENZIDINE (CAS No.: 91-94-1)	mg/kg	參考LFGB 82.02-2方法, 以氣相層析/質譜儀檢測. / With reference to LFGB 82.02-2. Analysis was performed by GC/MS.	3	n.d.	-
11): 3,3'-二甲氧基聯苯胺 / 3,3'-DIMETHOXYBENZIDINE (CAS No.: 119-90-4)	mg/kg	參考LFGB 82.02-2方法, 以氣相層析/質譜儀檢測. / With reference to LFGB 82.02-2. Analysis was performed by GC/MS.	3	n.d.	-
12): 3,3'-二甲基聯苯胺 / 3,3'-DIMETHYLBENZIDINE (CAS No.: 119-93-7)	mg/kg	參考LFGB 82.02-2方法, 以氣相層析/質譜儀檢測. / With reference to LFGB 82.02-2. Analysis was performed by GC/MS.	3	n.d.	-

This document is issued by the Company subject to its General Conditions of Service printed overleaf, available on request or accessible at <http://www.sgs.com/en/Terms-and-Conditions.aspx> and, for electronic format documents, subject to Terms and Conditions for Electronic Documents at <http://www.sgs.com/en/Terms-and-Conditions/Termse-Document.aspx>. Attention is drawn to the limitation of liability, indemnification and jurisdiction issues defined therein. Any holder of this document is advised that information contained hereon reflects the Company's findings at the time of its intervention only and within the limits of client's instruction, if any. The Company's sole responsibility is to its Client and this document does not exonerate parties to a transaction from exercising all their rights and obligations under the transaction documents. This document cannot be reproduced, except in full, without prior written approval of the Company. Any unauthorized alteration, forgery or falsification of the content or appearance of this document is unlawful and offenders may be prosecuted to the fullest extent of the law. Unless otherwise stated the results shown in this test report refer only to the sample(s) tested.

# 測試報告

號碼(No.) : CE/2015/20347

日期(Date) : 2015/02/16

頁數(Page): 14 of 65

# Test Report



南亞塑膠工業股份有限公司(台灣) / NAN YA PLASTICS CORPORATION (TAIWAN)

(南亞電子材料(昆山)有限公司 / NAN YA ELECTRONIC MATERIALS (KUNSHAN) CORP., LTD)

(南亞電子材料(惠州)有限公司 / NAN YA ELECTRONIC MATERIALS (HUIZHOU) CORP., LTD)

台灣台北市敦化北路201號 / 201 TUNG HWA NORTH ROAD, TAIPEI, TAIWAN

(江蘇省昆山市市長江南路201號 / 201 CHANG JIANG ROAD(S) KUNSHAN ECONOMIC & TECHNICAL DEVELOPMENT ZONE, JIANG SU)

(廣東省惠州市博羅縣石灣鎮永石大道 / YONGSHI BOULEVARD SHIWAN TOWN BOLUO COUNTY HUIZHOU CITY GUANG DONG)

測試項目 (Test Items)	單位 (Unit)	測試方法 (Method)	方法偵測 極限值 (MDL)	結果 (Result)	限值 (Limit)
				No.1	
13): 3,3'-二甲基-4,4'-二氨基二苯甲烷 / 3,3'-DIMETHYL-4,4'-DIAMINODIPHENYLMETHANE (CAS No.: 838-88-0)	mg/kg	參考LFGB 82.02-2方法, 以氣相層析/質譜儀檢測. / With reference to LFGB 82.02-2. Analysis was performed by GC/MS.	3	n.d.	-
14): 2-甲氧基-5-甲基聯苯 / P-CRESIDINE (2-METHOXY-5-METHYLANILINE) (CAS No.: 120-71-8)	mg/kg	參考LFGB 82.02-2方法, 以氣相層析/質譜儀檢測. / With reference to LFGB 82.02-2. Analysis was performed by GC/MS.	3	n.d.	-
15): 4,4'-亞甲基雙(氯苯胺) / 4,4'-METHYLENE-BIS-(2-CHLOROANILINE) (CAS No.: 101-14-4)	mg/kg	參考LFGB 82.02-2方法, 以氣相層析/質譜儀檢測. / With reference to LFGB 82.02-2. Analysis was performed by GC/MS.	3	n.d.	-
16): 4,4'-氧化雙苯胺 / 4,4'-OXYDIANILINE (CAS No.: 101-80-4)	mg/kg	參考LFGB 82.02-2方法, 以氣相層析/質譜儀檢測. / With reference to LFGB 82.02-2. Analysis was performed by GC/MS.	3	n.d.	-
17): 4,4'-硫代雙苯胺 / 4,4'-THIODIANILINE (CAS No.: 139-65-1)	mg/kg	參考LFGB 82.02-2方法, 以氣相層析/質譜儀檢測. / With reference to LFGB 82.02-2. Analysis was performed by GC/MS.	3	n.d.	-
18): 鄰甲苯胺 / O-TOLUIDINE (CAS No.: 95-53-4)	mg/kg	參考LFGB 82.02-2方法, 以氣相層析/質譜儀檢測. / With reference to LFGB 82.02-2. Analysis was performed by GC/MS.	3	n.d.	-
19): 2,4-二氨基甲苯 / 2,4-TOLUYLENEDIAMINE (CAS No.: 95-80-7)	mg/kg	參考LFGB 82.02-2方法, 以氣相層析/質譜儀檢測. / With reference to LFGB 82.02-2. Analysis was performed by GC/MS.	3	n.d.	-

This document is issued by the Company subject to its General Conditions of Service printed overleaf, available on request or accessible at <http://www.sgs.com/en/Terms-and-Conditions.aspx> and, for electronic format documents, subject to Terms and Conditions for Electronic Documents at <http://www.sgs.com/en/Terms-and-Conditions/Termse-Documents.aspx>. Attention is drawn to the limitation of liability, indemnification and jurisdiction issues defined therein. Any holder of this document is advised that information contained hereon reflects the Company's findings at the time of its intervention only and within the limits of client's instruction, if any. The Company's sole responsibility is to its Client and this document does not exonerate parties to a transaction from exercising all their rights and obligations under the transaction documents. This document cannot be reproduced, except in full, without prior written approval of the Company. Any unauthorized alteration, forgery or falsification of the content or appearance of this document is unlawful and offenders may be prosecuted to the fullest extent of the law. Unless otherwise stated the results shown in this test report refer only to the sample(s) tested.

# 測試報告

# Test Report

號碼(No.) : CE/2015/20347

日期(Date) : 2015/02/16

頁數(Page): 15 of 65



南亞塑膠工業股份有限公司(台灣) / NAN YA PLASTICS CORPORATION (TAIWAN)  
 (南亞電子材料(昆山)有限公司 / NAN YA ELECTRONIC MATERIALS (KUNSHAN) CORP., LTD)  
 (南亞電子材料(惠州)有限公司 / NAN YA ELECTRONIC MATERIALS (HUIZHOU) CORP., LTD)  
 台灣台北市敦化北路201號 / 201 TUNG HWA NORTH ROAD, TAIPEI, TAIWAN  
 (江蘇省昆山市長江南路201號 / 201 CHANG JIANG ROAD(S) KUNSHAN ECONOMIC & TECHNICAL DEVELOPMENT ZONE, JIANG SU)  
 (廣東省惠州市博羅縣石灣鎮永石大道 / YONGSHI BOULEVARD SHIWAN TOWN BOLUO COUNTY HUIZHOU CITY GUANG DONG)

測試項目 (Test Items)	單位 (Unit)	測試方法 (Method)	方法偵測 極限值 (MDL)	結果 (Result)	限值 (Limit)
				No.1	
20): 2,4,5-三甲基苯胺 / 2,4,5-TRIMETHYLANILINE (CAS No.: 137-17-7)	mg/kg	參考LFGB 82.02-2方法, 以氣相層析/質譜儀檢測. / With reference to LFGB 82.02-2. Analysis was performed by GC/MS.	3	n.d.	-
21): 鄰位甲氧基苯胺 / O-ANISIDINE (CAS No.: 90-04-0)	mg/kg	參考LFGB 82.02-2方法, 以氣相層析/質譜儀檢測. / With reference to LFGB 82.02-2. Analysis was performed by GC/MS.	3	n.d.	-
22): 對氨基偶氮苯 / 4-AMINOAZOBENZENE (CAS No.: 60-09-3)	mg/kg	參考LFGB 82.02-2方法, 以氣相層析/質譜儀檢測. / With reference to LFGB 82.02-2. Analysis was performed by GC/MS.	3	n.d.	-
23): 2,4-二甲基苯胺 / 2,4-XYLIDINE (CAS No.: 95-68-1)	mg/kg	參考LFGB 82.02-2方法, 以氣相層析/質譜儀檢測. / With reference to LFGB 82.02-2. Analysis was performed by GC/MS.	3	n.d.	-
24): 2,6-二甲基苯胺 / 2,6-XYLIDINE (CAS No.: 87-62-7)	mg/kg	參考LFGB 82.02-2方法, 以氣相層析/質譜儀檢測. / With reference to LFGB 82.02-2. Analysis was performed by GC/MS.	3	n.d.	-
<b>氫氟碳化物 / HFCs (Hydrofluorocarbon)</b>					
氫氟碳化物 (HFC)-23 (CHF <sub>3</sub> ) (CAS No.: 75-46-7)	mg/kg	參考US EPA 5021方法, 以氣相層析/質譜儀檢測. / With reference to US EPA 5021 method. Analysis was performed by GC/MS.	1	n.d.	-

This document is issued by the Company subject to its General Conditions of Service printed overleaf, available on request or accessible at <http://www.sgs.com/en/Terms-and-Conditions.aspx> and, for electronic format documents, subject to Terms and Conditions for Electronic Documents at <http://www.sgs.com/en/Terms-and-Conditions/Termse-Documents.aspx>. Attention is drawn to the limitation of liability, indemnification and jurisdiction issues defined therein. Any holder of this document is advised that information contained hereon reflects the Company's findings at the time of its intervention only and within the limits of client's instruction, if any. The Company's sole responsibility is to its Client and this document does not exonerate parties to a transaction from exercising all their rights and obligations under the transaction documents. This document cannot be reproduced, except in full, without prior written approval of the Company. Any unauthorized alteration, forgery or falsification of the content or appearance of this document is unlawful and offenders may be prosecuted to the fullest extent of the law. Unless otherwise stated the results shown in this test report refer only to the sample(s) tested.

# 測試報告

# Test Report

號碼(No.) : CE/2015/20347

日期(Date) : 2015/02/16

頁數(Page): 16 of 65



南亞塑膠工業股份有限公司(台灣) / NAN YA PLASTICS CORPORATION (TAIWAN)

(南亞電子材料(昆山)有限公司 / NAN YA ELECTRONIC MATERIALS (KUNSHAN) CORP., LTD)

(南亞電子材料(惠州)有限公司 / NAN YA ELECTRONIC MATERIALS (HUIZHOU) CORP., LTD)

台灣台北市敦化北路201號 / 201 TUNG HWA NORTH ROAD, TAIPEI, TAIWAN

(江蘇省昆山市市長江南路201號 / 201 CHANG JIANG ROAD(S) KUNSHAN ECONOMIC & TECHNICAL DEVELOPMENT ZONE, JIANG SU)

(廣東省惠州市博羅縣石灣鎮永石大道 / YONGSHI BOULEVARD SHIWAN TOWN BOLUO COUNTY HUIZHOU CITY GUANG DONG)

測試項目 (Test Items)	單位 (Unit)	測試方法 (Method)	方法偵測 極限值 (MDL)	結果 (Result)	限值 (Limit)
				No.1	
氫氟碳化物 (HFC)-32 (CH <sub>2</sub> F <sub>2</sub> ) (CAS No.: 75-10-5)	mg/kg	參考US EPA 5021方法, 以氣相層析/質譜儀檢測. / With reference to US EPA 5021 method. Analysis was performed by GC/MS.	1	n.d.	-
氫氟碳化物 (HFC)-41 (CH <sub>3</sub> F) (CAS No.: 593-53-3)	mg/kg	參考US EPA 5021方法, 以氣相層析/質譜儀檢測. / With reference to US EPA 5021 method. Analysis was performed by GC/MS.	1	n.d.	-
氫氟碳化物 (HFC)-43-10mee (C <sub>5</sub> H <sub>2</sub> F <sub>10</sub> )	mg/kg	參考US EPA 5021方法, 以氣相層析/質譜儀檢測. / With reference to US EPA 5021 method. Analysis was performed by GC/MS.	1	n.d.	-
氫氟碳化物 (HFC)-125 (C <sub>2</sub> H <sub>2</sub> F <sub>5</sub> )	mg/kg	參考US EPA 5021方法, 以氣相層析/質譜儀檢測. / With reference to US EPA 5021 method. Analysis was performed by GC/MS.	1	n.d.	-
氫氟碳化物 (HFC)-134 (C <sub>2</sub> H <sub>2</sub> F <sub>4</sub> )	mg/kg	參考US EPA 5021方法, 以氣相層析/質譜儀檢測. / With reference to US EPA 5021 method. Analysis was performed by GC/MS.	1	n.d.	-
氫氟碳化物 (HFC)-134a (CH <sub>2</sub> FCF <sub>3</sub> ) (CAS No.: 811-97-2)	mg/kg	參考US EPA 5021方法, 以氣相層析/質譜儀檢測. / With reference to US EPA 5021 method. Analysis was performed by GC/MS.	1	n.d.	-
氫氟碳化物 (HFC)-143 (CH <sub>3</sub> F <sub>3</sub> )	mg/kg	參考US EPA 5021方法, 以氣相層析/質譜儀檢測. / With reference to US EPA 5021 method. Analysis was performed by GC/MS.	1	n.d.	-

This document is issued by the Company subject to its General Conditions of Service printed overleaf, available on request or accessible at <http://www.sgs.com/en/Terms-and-Conditions.aspx> and, for electronic format documents, subject to Terms and Conditions for Electronic Documents at <http://www.sgs.com/en/Terms-and-Conditions/Termse-Document.aspx>. Attention is drawn to the limitation of liability, indemnification and jurisdiction issues defined therein. Any holder of this document is advised that information contained hereon reflects the Company's findings at the time of its intervention only and within the limits of client's instruction, if any. The Company's sole responsibility is to its Client and this document does not exonerate parties to a transaction from exercising all their rights and obligations under the transaction documents. This document cannot be reproduced, except in full, without prior written approval of the Company. Any unauthorized alteration, forgery or falsification of the content or appearance of this document is unlawful and offenders may be prosecuted to the fullest extent of the law. Unless otherwise stated the results shown in this test report refer only to the sample(s) tested.

# 測試報告

號碼(No.) : CE/2015/20347

日期(Date) : 2015/02/16

頁數(Page): 17 of 65

# Test Report



南亞塑膠工業股份有限公司(台灣) / NAN YA PLASTICS CORPORATION (TAIWAN)

(南亞電子材料(昆山)有限公司 / NAN YA ELECTRONIC MATERIALS (KUNSHAN) CORP., LTD)

(南亞電子材料(惠州)有限公司 / NAN YA ELECTRONIC MATERIALS (HUIZHOU) CORP., LTD)

台灣台北市敦化北路201號 / 201 TUNG HWA NORTH ROAD, TAIPEI, TAIWAN

(江蘇省昆山市長江南路201號 / 201 CHANG JIANG ROAD(S) KUNSHAN ECONOMIC & TECHNICAL DEVELOPMENT ZONE, JIANG SU)

(廣東省惠州市博羅縣石灣鎮永石大道 / YONGSHI BOULEVARD SHIWAN TOWN BOLUO COUNTY HUIZHOU CITY GUANG DONG)

測試項目 (Test Items)	單位 (Unit)	測試方法 (Method)	方法偵測 極限值 (MDL)	結果 (Result)	限值 (Limit)
				No.1	
氫氟碳化物 (HFC)-143a (CH3F3)	mg/kg	參考US EPA 5021方法, 以氣相層析/質譜儀檢測. / With reference to US EPA 5021 method. Analysis was performed by GC/MS.	1	n.d.	-
氫氟碳化物 (HFC)-152a (C2H4F2) (CAS No.: 75-37-6)	mg/kg	參考US EPA 5021方法, 以氣相層析/質譜儀檢測. / With reference to US EPA 5021 method. Analysis was performed by GC/MS.	1	n.d.	-
氫氟碳化物 (HFC)-227ea (C3HF7) (CAS No.: 431-89-0)	mg/kg	參考US EPA 5021方法, 以氣相層析/質譜儀檢測. / With reference to US EPA 5021 method. Analysis was performed by GC/MS.	1	n.d.	-
氫氟碳化物 (HFC)-236fa (C3H2F6)	mg/kg	參考US EPA 5021方法, 以氣相層析/質譜儀檢測. / With reference to US EPA 5021 method. Analysis was performed by GC/MS.	1	n.d.	-
氫氟碳化物 (HFC)-236ea (C3H2F6) (CAS No.: 431-63-0)	mg/kg	參考US EPA 5021方法, 以氣相層析/質譜儀檢測. / With reference to US EPA 5021 method. Analysis was performed by GC/MS.	1	n.d.	-
氫氟碳化物 (HFC)-245ca (C3H3F5)	mg/kg	參考US EPA 5021方法, 以氣相層析/質譜儀檢測. / With reference to US EPA 5021 method. Analysis was performed by GC/MS.	1	n.d.	-
氫氟碳化物 (HFC)-245fa (C3H3F5)	mg/kg	參考US EPA 5021方法, 以氣相層析/質譜儀檢測. / With reference to US EPA 5021 method. Analysis was performed by GC/MS.	1	n.d.	-

This document is issued by the Company subject to its General Conditions of Service printed overleaf, available on request or accessible at <http://www.sgs.com/en/Terms-and-Conditions.aspx> and, for electronic format documents, subject to Terms and Conditions for Electronic Documents at <http://www.sgs.com/en/Terms-and-Conditions/Termse-Document.aspx>. Attention is drawn to the limitation of liability, indemnification and jurisdiction issues defined therein. Any holder of this document is advised that information contained hereon reflects the Company's findings at the time of its intervention only and within the limits of client's instruction, if any. The Company's sole responsibility is to its Client and this document does not exonerate parties to a transaction from exercising all their rights and obligations under the transaction documents. This document cannot be reproduced, except in full, without prior written approval of the Company. Any unauthorized alteration, forgery or falsification of the content or appearance of this document is unlawful and offenders may be prosecuted to the fullest extent of the law. Unless otherwise stated the results shown in this test report refer only to the sample(s) tested.



# 測試報告

# Test Report

號碼(No.) : CE/2015/20347

日期(Date) : 2015/02/16

頁數(Page): 18 of 65



南亞塑膠工業股份有限公司(台灣) / NAN YA PLASTICS CORPORATION (TAIWAN)  
 (南亞電子材料(昆山)有限公司 / NAN YA ELECTRONIC MATERIALS (KUNSHAN) CORP., LTD)  
 (南亞電子材料(惠州)有限公司 / NAN YA ELECTRONIC MATERIALS (HUIZHOU) CORP., LTD)  
 台灣台北市敦化北路201號 / 201 TUNG HWA NORTH ROAD, TAIPEI, TAIWAN  
 (江蘇省昆山市市長江南路201號 / 201 CHANG JIANG ROAD(S) KUNSHAN ECONOMIC & TECHNICAL DEVELOPMENT ZONE, JIANG SU)  
 (廣東省惠州市博羅縣石灣鎮永石大道 / YONGSHI BOULEVARD SHIWAN TOWN BOLUO COUNTY HUIZHOU CITY GUANG DONG)

測試項目 (Test Items)	單位 (Unit)	測試方法 (Method)	方法偵測 極限值 (MDL)	結果 (Result)	限值 (Limit)
				No.1	
氫氟碳化物 (HFC)-365mfc (C4H5F5)	mg/kg	參考US EPA 5021方法, 以氣相層析/質譜儀檢測. / With reference to US EPA 5021 method. Analysis was performed by GC/MS.	1	n.d.	-
<b>全氟碳化物 / PFCs (Perfluorocarbon)</b>					
四氟甲烷 / F14 (CAS No.: 75-73-0)	mg/kg	參考US EPA 5021方法, 以氣相層析/質譜儀檢測. / With reference to US EPA 5021 method. Analysis was performed by GC/MS.	1	n.d.	-
六氟乙烷 / Fluorocarbon 116 (CAS No.: 76-16-4)	mg/kg	參考US EPA 5021方法, 以氣相層析/質譜儀檢測. / With reference to US EPA 5021 method. Analysis was performed by GC/MS.	1	n.d.	-
八氟丙烷 / Freon 218 (CAS No.: 76-19-7)	mg/kg	參考US EPA 5021方法, 以氣相層析/質譜儀檢測. / With reference to US EPA 5021 method. Analysis was performed by GC/MS.	1	n.d.	-
十氟丁烷 / Decafluorobutane (CAS No.: 355-25-9)	mg/kg	參考US EPA 5021方法, 以氣相層析/質譜儀檢測. / With reference to US EPA 5021 method. Analysis was performed by GC/MS.	1	n.d.	-
八氟環丁烷 / Freon C318 (CAS No.: 115-25-3)	mg/kg	參考US EPA 5021方法, 以氣相層析/質譜儀檢測. / With reference to US EPA 5021 method. Analysis was performed by GC/MS.	1	n.d.	-
全氟-1-丁烯 / Perfluor-1-butene (CAS No.: 357-26-6)	mg/kg	參考US EPA 5021方法, 以氣相層析/質譜儀檢測. / With reference to US EPA 5021 method. Analysis was performed by GC/MS.	1	n.d.	-

This document is issued by the Company subject to its General Conditions of Service printed overleaf, available on request or accessible at <http://www.sgs.com/en/Terms-and-Conditions.aspx> and, for electronic format documents, subject to Terms and Conditions for Electronic Documents at <http://www.sgs.com/en/Terms-and-Conditions/Termse-Documents.aspx>. Attention is drawn to the limitation of liability, indemnification and jurisdiction issues defined therein. Any holder of this document is advised that information contained hereon reflects the Company's findings at the time of its intervention only and within the limits of client's instruction, if any. The Company's sole responsibility is to its Client and this document does not exonerate parties to a transaction from exercising all their rights and obligations under the transaction documents. This document cannot be reproduced, except in full, without prior written approval of the Company. Any unauthorized alteration, forgery or falsification of the content or appearance of this document is unlawful and offenders may be prosecuted to the fullest extent of the law. Unless otherwise stated the results shown in this test report refer only to the sample(s) tested.

# 測試報告

號碼(No.) : CE/2015/20347

日期(Date) : 2015/02/16

頁數(Page): 19 of 65

# Test Report



南亞塑膠工業股份有限公司(台灣) / NAN YA PLASTICS CORPORATION (TAIWAN)

(南亞電子材料(昆山)有限公司 / NAN YA ELECTRONIC MATERIALS (KUNSHAN) CORP., LTD)

(南亞電子材料(惠州)有限公司 / NAN YA ELECTRONIC MATERIALS (HUIZHOU) CORP., LTD)

台灣台北市敦化北路201號 / 201 TUNG HWA NORTH ROAD, TAIPEI, TAIWAN

(江蘇省昆山市長江南路201號 / 201 CHANG JIANG ROAD(S) KUNSHAN ECONOMIC & TECHNICAL DEVELOPMENT ZONE, JIANG SU)

(廣東省惠州市博羅縣石灣鎮永石大道 / YONGSHI BOULEVARD SHIWAN TOWN BOLUO COUNTY HUIZHOU CITY GUANG DONG)

測試項目 (Test Items)	單位 (Unit)	測試方法 (Method)	方法偵測 極限值 (MDL)	結果 (Result)	限值 (Limit)
				No.1	
全氟異丁烯 / perfluorisobutene (CAS No.: 382-21-8)	mg/kg	參考US EPA 5021方法, 以氣相層析/質譜儀檢測. / With reference to US EPA 5021 method. Analysis was performed by GC/MS.	1	n.d.	-
1,4-二氫八氟丁烷 / 1,4-dihydrooctafluorobutane (CAS No.: 377-36-6)	mg/kg	參考US EPA 5021方法, 以氣相層析/質譜儀檢測. / With reference to US EPA 5021 method. Analysis was performed by GC/MS.	1	n.d.	-
2-全氟甲基丁烷 / nonafluor-2-(trifluoromethyl)butane (CAS No.: 594-91-2)	mg/kg	參考US EPA 5021方法, 以氣相層析/質譜儀檢測. / With reference to US EPA 5021 method. Analysis was performed by GC/MS.	1	n.d.	-
全氟戊烷 / perfluoro-n-pentane (CAS No.: 678-26-2)	mg/kg	參考US EPA 5021方法, 以氣相層析/質譜儀檢測. / With reference to US EPA 5021 method. Analysis was performed by GC/MS.	1	n.d.	-
2-全氟甲基戊烷 / 2-perfluoromethylpentane (CAS No.: 355-04-4)	mg/kg	參考US EPA 5021方法, 以氣相層析/質譜儀檢測. / With reference to US EPA 5021 method. Analysis was performed by GC/MS.	1	n.d.	-
全氟己烷 / perfluorohexane (CAS No.: 355-42-0)	mg/kg	參考US EPA 5021方法, 以氣相層析/質譜儀檢測. / With reference to US EPA 5021 method. Analysis was performed by GC/MS.	1	n.d.	-

This document is issued by the Company subject to its General Conditions of Service printed overleaf, available on request or accessible at <http://www.sgs.com/en/Terms-and-Conditions.aspx> and, for electronic format documents, subject to Terms and Conditions for Electronic Documents at <http://www.sgs.com/en/Terms-and-Conditions/Termse-Documents.aspx>. Attention is drawn to the limitation of liability, indemnification and jurisdiction issues defined therein. Any holder of this document is advised that information contained hereon reflects the Company's findings at the time of its intervention only and within the limits of client's instruction, if any. The Company's sole responsibility is to its Client and this document does not exonerate parties to a transaction from exercising all their rights and obligations under the transaction documents. This document cannot be reproduced, except in full, without prior written approval of the Company. Any unauthorized alteration, forgery or falsification of the content or appearance of this document is unlawful and offenders may be prosecuted to the fullest extent of the law. Unless otherwise stated the results shown in this test report refer only to the sample(s) tested.

# 測試報告

# Test Report

號碼(No.) : CE/2015/20347

日期(Date) : 2015/02/16

頁數(Page): 20 of 65



南亞塑膠工業股份有限公司(台灣) / NAN YA PLASTICS CORPORATION (TAIWAN)

(南亞電子材料(昆山)有限公司 / NAN YA ELECTRONIC MATERIALS (KUNSHAN) CORP., LTD)

(南亞電子材料(惠州)有限公司 / NAN YA ELECTRONIC MATERIALS (HUIZHOU) CORP., LTD)

台灣台北市敦化北路201號 / 201 TUNG HWA NORTH ROAD, TAIPEI, TAIWAN

(江蘇省昆山市長江南路201號 / 201 CHANG JIANG ROAD(S) KUNSHAN ECONOMIC & TECHNICAL DEVELOPMENT ZONE, JIANG SU)

(廣東省惠州市博羅縣石灣鎮永石大道 / YONGSHI BOULEVARD SHIWAN TOWN BOLUO COUNTY HUIZHOU CITY GUANG DONG)

測試項目 (Test Items)	單位 (Unit)	測試方法 (Method)	方法偵測 極限值 (MDL)	結果 (Result)	限值 (Limit)
				No.1	
氟氯碳化物 / CFCs (Chlorofluorocarbons)					
Group I					
氟氯碳化物 (Chlorofluorocarbon)-11 (CAS No.: 75-69-4)	mg/kg	參考US EPA 5021方法, 以氣相層析/質譜儀檢測. / With reference to US EPA 5021 method. Analysis was performed by GC/MS.	1	n.d.	-
氟氯碳化物 (Chlorofluorocarbon)-12 (CAS No.: 75-71-8)	mg/kg	參考US EPA 5021方法, 以氣相層析/質譜儀檢測. / With reference to US EPA 5021 method. Analysis was performed by GC/MS.	1	n.d.	-
氟氯碳化物 (Chlorofluorocarbon)-113 (CAS No.: 76-13-1)	mg/kg	參考US EPA 5021方法, 以氣相層析/質譜儀檢測. / With reference to US EPA 5021 method. Analysis was performed by GC/MS.	1	n.d.	-
氟氯碳化物 (Chlorofluorocarbon)-114 (CAS No.: 76-14-2)	mg/kg	參考US EPA 5021方法, 以氣相層析/質譜儀檢測. / With reference to US EPA 5021 method. Analysis was performed by GC/MS.	1	n.d.	-
氟氯碳化物 (Chlorofluorocarbon)-115 (CAS No.: 76-15-3)	mg/kg	參考US EPA 5021方法, 以氣相層析/質譜儀檢測. / With reference to US EPA 5021 method. Analysis was performed by GC/MS.	1	n.d.	-
Group III					
氟氯碳化物 (Chlorofluorocarbon)-13 (CAS No.: 75-72-9)	mg/kg	參考US EPA 5021方法, 以氣相層析/質譜儀檢測. / With reference to US EPA 5021 method. Analysis was performed by GC/MS.	1	n.d.	-

This document is issued by the Company subject to its General Conditions of Service printed overleaf, available on request or accessible at <http://www.sgs.com/en/Terms-and-Conditions.aspx> and, for electronic format documents, subject to Terms and Conditions for Electronic Documents at <http://www.sgs.com/en/Terms-and-Conditions/Termse-Documents.aspx>. Attention is drawn to the limitation of liability, indemnification and jurisdiction issues defined therein. Any holder of this document is advised that information contained hereon reflects the Company's findings at the time of its intervention only and within the limits of client's instruction, if any. The Company's sole responsibility is to its Client and this document does not exonerate parties to a transaction from exercising all their rights and obligations under the transaction documents. This document cannot be reproduced, except in full, without prior written approval of the Company. Any unauthorized alteration, forgery or falsification of the content or appearance of this document is unlawful and offenders may be prosecuted to the fullest extent of the law. Unless otherwise stated the results shown in this test report refer only to the sample(s) tested.

# 測試報告

# Test Report

號碼(No.) : CE/2015/20347

日期(Date) : 2015/02/16

頁數(Page): 21 of 65



南亞塑膠工業股份有限公司(台灣) / NAN YA PLASTICS CORPORATION (TAIWAN)

(南亞電子材料(昆山)有限公司 / NAN YA ELECTRONIC MATERIALS (KUNSHAN) CORP., LTD)

(南亞電子材料(惠州)有限公司 / NAN YA ELECTRONIC MATERIALS (HUIZHOU) CORP., LTD)

台灣台北市敦化北路201號 / 201 TUNG HWA NORTH ROAD, TAIPEI, TAIWAN

(江蘇省昆山市長江南路201號 / 201 CHANG JIANG ROAD(S) KUNSHAN ECONOMIC & TECHNICAL DEVELOPMENT ZONE, JIANG SU)

(廣東省惠州市博羅縣石灣鎮永石大道 / YONGSHI BOULEVARD SHIWAN TOWN BOLUO COUNTY HUIZHOU CITY GUANG DONG)

測試項目 (Test Items)	單位 (Unit)	測試方法 (Method)	方法偵測 極限值 (MDL)	結果 (Result)	限值 (Limit)
				No.1	
氟氯碳化物 (Chlorofluorocarbon)-111 (CAS No.: 354-56-3)	mg/kg	參考US EPA 5021方法, 以氣相層析/質譜儀檢測. / With reference to US EPA 5021 method. Analysis was performed by GC/MS.	1	n.d.	-
氟氯碳化物 (Chlorofluorocarbon)-112 (CAS No.: 76-12-0)	mg/kg	參考US EPA 5021方法, 以氣相層析/質譜儀檢測. / With reference to US EPA 5021 method. Analysis was performed by GC/MS.	1	n.d.	-
氟氯碳化物 (Chlorofluorocarbon)-211 (CAS No.: 422-78-6)	mg/kg	參考US EPA 5021方法, 以氣相層析/質譜儀檢測. / With reference to US EPA 5021 method. Analysis was performed by GC/MS.	1	n.d.	-
氟氯碳化物 (Chlorofluorocarbon)-212 (CAS No.: 3182-26-1)	mg/kg	參考US EPA 5021方法, 以氣相層析/質譜儀檢測. / With reference to US EPA 5021 method. Analysis was performed by GC/MS.	1	n.d.	-
氟氯碳化物 (Chlorofluorocarbon)-213 (CAS No.: 2354-06-5)	mg/kg	參考US EPA 5021方法, 以氣相層析/質譜儀檢測. / With reference to US EPA 5021 method. Analysis was performed by GC/MS.	1	n.d.	-
氟氯碳化物 (Chlorofluorocarbon)-214 (CAS No.: 29255-31-0)	mg/kg	參考US EPA 5021方法, 以氣相層析/質譜儀檢測. / With reference to US EPA 5021 method. Analysis was performed by GC/MS.	1	n.d.	-
氟氯碳化物 (Chlorofluorocarbon)-215 (CAS No.: 4259-43-2)	mg/kg	參考US EPA 5021方法, 以氣相層析/質譜儀檢測. / With reference to US EPA 5021 method. Analysis was performed by GC/MS.	1	n.d.	-

This document is issued by the Company subject to its General Conditions of Service printed overleaf, available on request or accessible at <http://www.sgs.com/en/Terms-and-Conditions.aspx> and, for electronic format documents, subject to Terms and Conditions for Electronic Documents at <http://www.sgs.com/en/Terms-and-Conditions/Termse-Documents.aspx>. Attention is drawn to the limitation of liability, indemnification and jurisdiction issues defined therein. Any holder of this document is advised that information contained hereon reflects the Company's findings at the time of its intervention only and within the limits of client's instruction, if any. The Company's sole responsibility is to its Client and this document does not exonerate parties to a transaction from exercising all their rights and obligations under the transaction documents. This document cannot be reproduced, except in full, without prior written approval of the Company. Any unauthorized alteration, forgery or falsification of the content or appearance of this document is unlawful and offenders may be prosecuted to the fullest extent of the law. Unless otherwise stated the results shown in this test report refer only to the sample(s) tested.

# 測試報告

# Test Report

號碼(No.) : CE/2015/20347

日期(Date) : 2015/02/16

頁數(Page): 22 of 65



南亞塑膠工業股份有限公司(台灣) / NAN YA PLASTICS CORPORATION (TAIWAN)

(南亞電子材料(昆山)有限公司 / NAN YA ELECTRONIC MATERIALS (KUNSHAN) CORP., LTD)

(南亞電子材料(惠州)有限公司 / NAN YA ELECTRONIC MATERIALS (HUIZHOU) CORP., LTD)

台灣台北市敦化北路201號 / 201 TUNG HWA NORTH ROAD, TAIPEI, TAIWAN

(江蘇省昆山市長江南路201號 / 201 CHANG JIANG ROAD(S) KUNSHAN ECONOMIC & TECHNICAL DEVELOPMENT ZONE, JIANG SU)

(廣東省惠州市博羅縣石灣鎮永石大道 / YONGSHI BOULEVARD SHIWAN TOWN BOLUO COUNTY HUIZHOU CITY GUANG DONG)

測試項目 (Test Items)	單位 (Unit)	測試方法 (Method)	方法偵測 極限值 (MDL)	結果 (Result)	限值 (Limit)
				No.1	
氟氯碳化物 (Chlorofluorocarbon)-216 (CAS No.: 661-97-2)	mg/kg	參考US EPA 5021方法, 以氣相層析/質譜儀檢測. / With reference to US EPA 5021 method. Analysis was performed by GC/MS.	1	n.d.	-
氟氯碳化物 (Chlorofluorocarbon)-217 (CAS No.: 422-86-6)	mg/kg	參考US EPA 5021方法, 以氣相層析/質譜儀檢測. / With reference to US EPA 5021 method. Analysis was performed by GC/MS.	1	n.d.	-
<b>氟氯氫碳化物 / HCFCs (Hydrochlorofluorocarbons)</b>					
氟氯氫碳化物 (HCFC)-21 (CAS No.: 75-43-4)	mg/kg	參考US EPA 5021方法, 以氣相層析/質譜儀檢測. / With reference to US EPA 5021 method. Analysis was performed by GC/MS.	1	n.d.	-
氟氯氫碳化物 (HCFC)-22 (CAS No.: 75-45-6)	mg/kg	參考US EPA 5021方法, 以氣相層析/質譜儀檢測. / With reference to US EPA 5021 method. Analysis was performed by GC/MS.	1	n.d.	-
氟氯氫碳化物 (HCFC)-31 (CAS No.: 593-70-4)	mg/kg	參考US EPA 5021方法, 以氣相層析/質譜儀檢測. / With reference to US EPA 5021 method. Analysis was performed by GC/MS.	1	n.d.	-
氟氯氫碳化物 (HCFC)-121 (CAS No.: 354-14-3)	mg/kg	參考US EPA 5021方法, 以氣相層析/質譜儀檢測. / With reference to US EPA 5021 method. Analysis was performed by GC/MS.	1	n.d.	-

This document is issued by the Company subject to its General Conditions of Service printed overleaf, available on request or accessible at <http://www.sgs.com/en/Terms-and-Conditions.aspx> and, for electronic format documents, subject to Terms and Conditions for Electronic Documents at <http://www.sgs.com/en/Terms-and-Conditions/Termse-Documents.aspx>. Attention is drawn to the limitation of liability, indemnification and jurisdiction issues defined therein. Any holder of this document is advised that information contained hereon reflects the Company's findings at the time of its intervention only and within the limits of client's instruction, if any. The Company's sole responsibility is to its Client and this document does not exonerate parties to a transaction from exercising all their rights and obligations under the transaction documents. This document cannot be reproduced, except in full, without prior written approval of the Company. Any unauthorized alteration, forgery or falsification of the content or appearance of this document is unlawful and offenders may be prosecuted to the fullest extent of the law. Unless otherwise stated the results shown in this test report refer only to the sample(s) tested.



# 測試報告

# Test Report

號碼(No.) : CE/2015/20347

日期(Date) : 2015/02/16

頁數(Page): 23 of 65



南亞塑膠工業股份有限公司(台灣) / NAN YA PLASTICS CORPORATION (TAIWAN)

(南亞電子材料(昆山)有限公司 / NAN YA ELECTRONIC MATERIALS (KUNSHAN) CORP., LTD)

(南亞電子材料(惠州)有限公司 / NAN YA ELECTRONIC MATERIALS (HUIZHOU) CORP., LTD)

台灣台北市敦化北路201號 / 201 TUNG HWA NORTH ROAD, TAIPEI, TAIWAN

(江蘇省昆山市長江南路201號 / 201 CHANG JIANG ROAD(S) KUNSHAN ECONOMIC & TECHNICAL DEVELOPMENT ZONE, JIANG SU)

(廣東省惠州市博羅縣石灣鎮永石大道 / YONGSHI BOULEVARD SHIWAN TOWN BOLUO COUNTY HUIZHOU CITY GUANG DONG)

測試項目 (Test Items)	單位 (Unit)	測試方法 (Method)	方法偵測 極限值 (MDL)	結果 (Result)	限值 (Limit)
				No.1	
氟氯氫碳化物 (HCFC)-122 (CAS No.: 354-21-2)	mg/kg	參考US EPA 5021方法, 以氣相層析/質譜儀檢測. / With reference to US EPA 5021 method. Analysis was performed by GC/MS.	1	n.d.	-
氟氯氫碳化物 (HCFC)-123 (CAS No.: 306-83-2)	mg/kg	參考US EPA 5021方法, 以氣相層析/質譜儀檢測. / With reference to US EPA 5021 method. Analysis was performed by GC/MS.	1	n.d.	-
氟氯氫碳化物 (HCFC)-124 (CAS No.: 2837-89-0)	mg/kg	參考US EPA 5021方法, 以氣相層析/質譜儀檢測. / With reference to US EPA 5021 method. Analysis was performed by GC/MS.	1	n.d.	-
氟氯氫碳化物 (HCFC)-131 (CAS No.: 359-28-4)	mg/kg	參考US EPA 5021方法, 以氣相層析/質譜儀檢測. / With reference to US EPA 5021 method. Analysis was performed by GC/MS.	1	n.d.	-
氟氯氫碳化物 (HCFC)-132b (CAS No.: 1649-08-7)	mg/kg	參考US EPA 5021方法, 以氣相層析/質譜儀檢測. / With reference to US EPA 5021 method. Analysis was performed by GC/MS.	1	n.d.	-
氟氯氫碳化物 (HCFC)-133a (CAS No.: 75-88-7)	mg/kg	參考US EPA 5021方法, 以氣相層析/質譜儀檢測. / With reference to US EPA 5021 method. Analysis was performed by GC/MS.	1	n.d.	-
氟氯氫碳化物 (HCFC)-141b (CAS No.: 1717-00-6)	mg/kg	參考US EPA 5021方法, 以氣相層析/質譜儀檢測. / With reference to US EPA 5021 method. Analysis was performed by GC/MS.	1	n.d.	-

This document is issued by the Company subject to its General Conditions of Service printed overleaf, available on request or accessible at <http://www.sgs.com/en/Terms-and-Conditions.aspx> and, for electronic format documents, subject to Terms and Conditions for Electronic Documents at <http://www.sgs.com/en/Terms-and-Conditions/Termse-Document.aspx>. Attention is drawn to the limitation of liability, indemnification and jurisdiction issues defined therein. Any holder of this document is advised that information contained hereon reflects the Company's findings at the time of its intervention only and within the limits of client's instruction, if any. The Company's sole responsibility is to its Client and this document does not exonerate parties to a transaction from exercising all their rights and obligations under the transaction documents. This document cannot be reproduced, except in full, without prior written approval of the Company. Any unauthorized alteration, forgery or falsification of the content or appearance of this document is unlawful and offenders may be prosecuted to the fullest extent of the law. Unless otherwise stated the results shown in this test report refer only to the sample(s) tested.

# 測試報告

# Test Report

號碼(No.) : CE/2015/20347

日期(Date) : 2015/02/16

頁數(Page): 24 of 65



南亞塑膠工業股份有限公司(台灣) / NAN YA PLASTICS CORPORATION (TAIWAN)

(南亞電子材料(昆山)有限公司 / NAN YA ELECTRONIC MATERIALS (KUNSHAN) CORP., LTD)

(南亞電子材料(惠州)有限公司 / NAN YA ELECTRONIC MATERIALS (HUIZHOU) CORP., LTD)

台灣台北市敦化北路201號 / 201 TUNG HWA NORTH ROAD, TAIPEI, TAIWAN

(江蘇省昆山市長江南路201號 / 201 CHANG JIANG ROAD(S) KUNSHAN ECONOMIC & TECHNICAL DEVELOPMENT ZONE, JIANG SU)

(廣東省惠州市博羅縣石灣鎮永石大道 / YONGSHI BOULEVARD SHIWAN TOWN BOLUO COUNTY HUIZHOU CITY GUANG DONG)

測試項目 (Test Items)	單位 (Unit)	測試方法 (Method)	方法偵測 極限值 (MDL)	結果 (Result)	限值 (Limit)
				No.1	
氟氯氫碳化物 (HCFC)-142b (CAS No.: 75-68-3)	mg/kg	參考US EPA 5021方法, 以氣相層析/質譜儀檢測. / With reference to US EPA 5021 method. Analysis was performed by GC/MS.	1	n.d.	-
氟氯氫碳化物 (HCFC)-221 (CAS No.: 422-26-4)	mg/kg	參考US EPA 5021方法, 以氣相層析/質譜儀檢測. / With reference to US EPA 5021 method. Analysis was performed by GC/MS.	1	n.d.	-
氟氯氫碳化物 (HCFC)-222 (CAS No.: 422-49-1)	mg/kg	參考US EPA 5021方法, 以氣相層析/質譜儀檢測. / With reference to US EPA 5021 method. Analysis was performed by GC/MS.	1	n.d.	-
氟氯氫碳化物 (HCFC)-223 (CAS No.: 422-52-6)	mg/kg	參考US EPA 5021方法, 以氣相層析/質譜儀檢測. / With reference to US EPA 5021 method. Analysis was performed by GC/MS.	1	n.d.	-
氟氯氫碳化物 (HCFC)-224 (CAS No.: 422-54-8)	mg/kg	參考US EPA 5021方法, 以氣相層析/質譜儀檢測. / With reference to US EPA 5021 method. Analysis was performed by GC/MS.	1	n.d.	-
氟氯氫碳化物 (HCFC)-225ca (CAS No.: 422-56-0)	mg/kg	參考US EPA 5021方法, 以氣相層析/質譜儀檢測. / With reference to US EPA 5021 method. Analysis was performed by GC/MS.	1	n.d.	-
氟氯氫碳化物 (HCFC)-225cb (CAS No.: 507-55-1)	mg/kg	參考US EPA 5021方法, 以氣相層析/質譜儀檢測. / With reference to US EPA 5021 method. Analysis was performed by GC/MS.	1	n.d.	-

This document is issued by the Company subject to its General Conditions of Service printed overleaf, available on request or accessible at <http://www.sgs.com/en/Terms-and-Conditions.aspx> and, for electronic format documents, subject to Terms and Conditions for Electronic Documents at <http://www.sgs.com/en/Terms-and-Conditions/Termse-Document.aspx>. Attention is drawn to the limitation of liability, indemnification and jurisdiction issues defined therein. Any holder of this document is advised that information contained hereon reflects the Company's findings at the time of its intervention only and within the limits of client's instruction, if any. The Company's sole responsibility is to its Client and this document does not exonerate parties to a transaction from exercising all their rights and obligations under the transaction documents. This document cannot be reproduced, except in full, without prior written approval of the Company. Any unauthorized alteration, forgery or falsification of the content or appearance of this document is unlawful and offenders may be prosecuted to the fullest extent of the law. Unless otherwise stated the results shown in this test report refer only to the sample(s) tested.

# 測試報告

# Test Report

號碼(No.) : CE/2015/20347

日期(Date) : 2015/02/16

頁數(Page): 25 of 65



南亞塑膠工業股份有限公司(台灣) / NAN YA PLASTICS CORPORATION (TAIWAN)

(南亞電子材料(昆山)有限公司 / NAN YA ELECTRONIC MATERIALS (KUNSHAN) CORP., LTD)

(南亞電子材料(惠州)有限公司 / NAN YA ELECTRONIC MATERIALS (HUIZHOU) CORP., LTD)

台灣台北市敦化北路201號 / 201 TUNG HWA NORTH ROAD, TAIPEI, TAIWAN

(江蘇省昆山市長江南路201號 / 201 CHANG JIANG ROAD(S) KUNSHAN ECONOMIC & TECHNICAL DEVELOPMENT ZONE, JIANG SU)

(廣東省惠州市博羅縣石灣鎮永石大道 / YONGSHI BOULEVARD SHIWAN TOWN BOLUO COUNTY HUIZHOU CITY GUANG DONG)

測試項目 (Test Items)	單位 (Unit)	測試方法 (Method)	方法偵測 極限值 (MDL)	結果 (Result)	限值 (Limit)
				No.1	
氟氯氫碳化物 (HCFC)-226 (CAS No.: 431-87-8)	mg/kg	參考US EPA 5021方法, 以氣相層析/質譜儀檢測. / With reference to US EPA 5021 method. Analysis was performed by GC/MS.	1	n.d.	-
氟氯氫碳化物 (HCFC)-231 (CAS No.: 421-94-3)	mg/kg	參考US EPA 5021方法, 以氣相層析/質譜儀檢測. / With reference to US EPA 5021 method. Analysis was performed by GC/MS.	1	n.d.	-
氟氯氫碳化物 (HCFC)-232 (CAS No.: 460-89-9)	mg/kg	參考US EPA 5021方法, 以氣相層析/質譜儀檢測. / With reference to US EPA 5021 method. Analysis was performed by GC/MS.	1	n.d.	-
氟氯氫碳化物 (HCFC)-233 (CAS No.: 7125-84-0)	mg/kg	參考US EPA 5021方法, 以氣相層析/質譜儀檢測. / With reference to US EPA 5021 method. Analysis was performed by GC/MS.	1	n.d.	-
氟氯氫碳化物 (HCFC)-234 (CAS No.: 425-94-5)	mg/kg	參考US EPA 5021方法, 以氣相層析/質譜儀檢測. / With reference to US EPA 5021 method. Analysis was performed by GC/MS.	1	n.d.	-
氟氯氫碳化物 (HCFC)-235 (CAS No.: 460-92-4)	mg/kg	參考US EPA 5021方法, 以氣相層析/質譜儀檢測. / With reference to US EPA 5021 method. Analysis was performed by GC/MS.	1	n.d.	-
氟氯氫碳化物 (HCFC)-241 (CAS No.: 666-27-3)	mg/kg	參考US EPA 5021方法, 以氣相層析/質譜儀檢測. / With reference to US EPA 5021 method. Analysis was performed by GC/MS.	1	n.d.	-

This document is issued by the Company subject to its General Conditions of Service printed overleaf, available on request or accessible at <http://www.sgs.com/en/Terms-and-Conditions.aspx> and, for electronic format documents, subject to Terms and Conditions for Electronic Documents at <http://www.sgs.com/en/Terms-and-Conditions/Termse-Document.aspx>. Attention is drawn to the limitation of liability, indemnification and jurisdiction issues defined therein. Any holder of this document is advised that information contained hereon reflects the Company's findings at the time of its intervention only and within the limits of client's instruction, if any. The Company's sole responsibility is to its Client and this document does not exonerate parties to a transaction from exercising all their rights and obligations under the transaction documents. This document cannot be reproduced, except in full, without prior written approval of the Company. Any unauthorized alteration, forgery or falsification of the content or appearance of this document is unlawful and offenders may be prosecuted to the fullest extent of the law. Unless otherwise stated the results shown in this test report refer only to the sample(s) tested.

# 測試報告

# Test Report

號碼(No.) : CE/2015/20347

日期(Date) : 2015/02/16

頁數(Page): 26 of 65



南亞塑膠工業股份有限公司(台灣) / NAN YA PLASTICS CORPORATION (TAIWAN)

(南亞電子材料(昆山)有限公司 / NAN YA ELECTRONIC MATERIALS (KUNSHAN) CORP., LTD)

(南亞電子材料(惠州)有限公司 / NAN YA ELECTRONIC MATERIALS (HUIZHOU) CORP., LTD)

台灣台北市敦化北路201號 / 201 TUNG HWA NORTH ROAD, TAIPEI, TAIWAN

(江蘇省昆山市長江南路201號 / 201 CHANG JIANG ROAD(S) KUNSHAN ECONOMIC & TECHNICAL DEVELOPMENT ZONE, JIANG SU)

(廣東省惠州市博羅縣石灣鎮永石大道 / YONGSHI BOULEVARD SHIWAN TOWN BOLUO COUNTY HUIZHOU CITY GUANG DONG)

測試項目 (Test Items)	單位 (Unit)	測試方法 (Method)	方法偵測 極限值 (MDL)	結果 (Result)	限值 (Limit)
				No.1	
氟氯氫碳化物 (HCFC)-242 (CAS No.: 460-63-9)	mg/kg	參考US EPA 5021方法, 以氣相層析/質譜儀檢測. / With reference to US EPA 5021 method. Analysis was performed by GC/MS.	1	n.d.	-
氟氯氫碳化物 (HCFC)-243 (CAS No.: 460-69-5)	mg/kg	參考US EPA 5021方法, 以氣相層析/質譜儀檢測. / With reference to US EPA 5021 method. Analysis was performed by GC/MS.	1	n.d.	-
氟氯氫碳化物 (HCFC)-244	mg/kg	參考US EPA 5021方法, 以氣相層析/質譜儀檢測. / With reference to US EPA 5021 method. Analysis was performed by GC/MS.	1	n.d.	-
氟氯氫碳化物 (HCFC)-251 (CAS No.: 421-41-0)	mg/kg	參考US EPA 5021方法, 以氣相層析/質譜儀檢測. / With reference to US EPA 5021 method. Analysis was performed by GC/MS.	1	n.d.	-
氟氯氫碳化物 (HCFC)-252 (CAS No.: 819-00-1)	mg/kg	參考US EPA 5021方法, 以氣相層析/質譜儀檢測. / With reference to US EPA 5021 method. Analysis was performed by GC/MS.	1	n.d.	-
氟氯氫碳化物 (HCFC)-253 (CAS No.: 460-35-5)	mg/kg	參考US EPA 5021方法, 以氣相層析/質譜儀檢測. / With reference to US EPA 5021 method. Analysis was performed by GC/MS.	1	n.d.	-
氟氯氫碳化物 (HCFC)-261 (CAS No.: 420-97-3)	mg/kg	參考US EPA 5021方法, 以氣相層析/質譜儀檢測. / With reference to US EPA 5021 method. Analysis was performed by GC/MS.	1	n.d.	-

This document is issued by the Company subject to its General Conditions of Service printed overleaf, available on request or accessible at <http://www.sgs.com/en/Terms-and-Conditions.aspx> and, for electronic format documents, subject to Terms and Conditions for Electronic Documents at <http://www.sgs.com/en/Terms-and-Conditions/Termse-Document.aspx>. Attention is drawn to the limitation of liability, indemnification and jurisdiction issues defined therein. Any holder of this document is advised that information contained hereon reflects the Company's findings at the time of its intervention only and within the limits of client's instruction, if any. The Company's sole responsibility is to its Client and this document does not exonerate parties to a transaction from exercising all their rights and obligations under the transaction documents. This document cannot be reproduced, except in full, without prior written approval of the Company. Any unauthorized alteration, forgery or falsification of the content or appearance of this document is unlawful and offenders may be prosecuted to the fullest extent of the law. Unless otherwise stated the results shown in this test report refer only to the sample(s) tested.

# 測試報告

# Test Report

號碼(No.) : CE/2015/20347

日期(Date) : 2015/02/16

頁數(Page): 27 of 65



南亞塑膠工業股份有限公司(台灣) / NAN YA PLASTICS CORPORATION (TAIWAN)

(南亞電子材料(昆山)有限公司 / NAN YA ELECTRONIC MATERIALS (KUNSHAN) CORP., LTD)

(南亞電子材料(惠州)有限公司 / NAN YA ELECTRONIC MATERIALS (HUIZHOU) CORP., LTD)

台灣台北市敦化北路201號 / 201 TUNG HWA NORTH ROAD, TAIPEI, TAIWAN

(江蘇省昆山市長江南路201號 / 201 CHANG JIANG ROAD(S) KUNSHAN ECONOMIC & TECHNICAL DEVELOPMENT ZONE, JIANG SU)

(廣東省惠州市博羅縣石灣鎮永石大道 / YONGSHI BOULEVARD SHIWAN TOWN BOLUO COUNTY HUIZHOU CITY GUANG DONG)

測試項目 (Test Items)	單位 (Unit)	測試方法 (Method)	方法偵測 極限值 (MDL)	結果 (Result)	限值 (Limit)
				No.1	
氟氯氫碳化物 (HCFC)-262 (CAS No.: 421-02-03)	mg/kg	參考US EPA 5021方法, 以氣相層析/質譜儀檢測. / With reference to US EPA 5021 method. Analysis was performed by GC/MS.	1	n.d.	-
氟氯氫碳化物 (HCFC)-271 (CAS No.: 430-55-7)	mg/kg	參考US EPA 5021方法, 以氣相層析/質譜儀檢測. / With reference to US EPA 5021 method. Analysis was performed by GC/MS.	1	n.d.	-
<b>海龍 (Halons)</b>					
海龍 (Halon)-1211 (CAS No.: 353-59-3)	mg/kg	參考US EPA 5021方法, 以氣相層析/質譜儀檢測. / With reference to US EPA 5021 method. Analysis was performed by GC/MS.	1	n.d.	-
海龍 (Halon)-1301 (CAS No.: 75-63-8)	mg/kg	參考US EPA 5021方法, 以氣相層析/質譜儀檢測. / With reference to US EPA 5021 method. Analysis was performed by GC/MS.	1	n.d.	-
海龍 (Halon)-2402 (CAS No.: 124-73-2)	mg/kg	參考US EPA 5021方法, 以氣相層析/質譜儀檢測. / With reference to US EPA 5021 method. Analysis was performed by GC/MS.	1	n.d.	-

This document is issued by the Company subject to its General Conditions of Service printed overleaf, available on request or accessible at <http://www.sgs.com/en/Terms-and-Conditions.aspx> and, for electronic format documents, subject to Terms and Conditions for Electronic Documents at <http://www.sgs.com/en/Terms-and-Conditions/Termse-Documents.aspx>. Attention is drawn to the limitation of liability, indemnification and jurisdiction issues defined therein. Any holder of this document is advised that information contained hereon reflects the Company's findings at the time of its intervention only and within the limits of client's instruction, if any. The Company's sole responsibility is to its Client and this document does not exonerate parties to a transaction from exercising all their rights and obligations under the transaction documents. This document cannot be reproduced, except in full, without prior written approval of the Company. Any unauthorized alteration, forgery or falsification of the content or appearance of this document is unlawful and offenders may be prosecuted to the fullest extent of the law. Unless otherwise stated the results shown in this test report refer only to the sample(s) tested.



# 測試報告

# Test Report

號碼(No.) : CE/2015/20347

日期(Date) : 2015/02/16

頁數(Page): 28 of 65



南亞塑膠工業股份有限公司(台灣) / NAN YA PLASTICS CORPORATION (TAIWAN)

(南亞電子材料(昆山)有限公司 / NAN YA ELECTRONIC MATERIALS (KUNSHAN) CORP., LTD)

(南亞電子材料(惠州)有限公司 / NAN YA ELECTRONIC MATERIALS (HUIZHOU) CORP., LTD)

台灣台北市敦化北路201號 / 201 TUNG HWA NORTH ROAD, TAIPEI, TAIWAN

(江蘇省昆山市市長江南路201號 / 201 CHANG JIANG ROAD(S) KUNSHAN ECONOMIC & TECHNICAL DEVELOPMENT ZONE, JIANG SU)

(廣東省惠州市博羅縣石灣鎮永石大道 / YONGSHI BOULEVARD SHIWAN TOWN BOLUO COUNTY HUIZHOU CITY GUANG DONG)

測試項目 (Test Items)	單位 (Unit)	測試方法 (Method)	方法偵測 極限值 (MDL)	結果 (Result)	限值 (Limit)
				No.1	
不完全鹵化氟溴化物 / HBFCs (Hydrobromofluorocarbons)					
不完全鹵化氟溴化物 (HBFC)-21B2 (CH <sub>2</sub> FBr <sub>2</sub> ) (CAS No.: 1868-53-7)	mg/kg	參考US EPA 5021方法, 以氣相層析/質譜儀檢測. / With reference to US EPA 5021 method. Analysis was performed by GC/MS.	1	n.d.	-
不完全鹵化氟溴化物 (HBFC)-22B1 (CH <sub>2</sub> F <sub>2</sub> Br) (CAS No.: 1511-62-2)	mg/kg	參考US EPA 5021方法, 以氣相層析/質譜儀檢測. / With reference to US EPA 5021 method. Analysis was performed by GC/MS.	1	n.d.	-
不完全鹵化氟溴化物 (HBFC)-31B1 (CH <sub>2</sub> FBr) (CAS No.: 373-52-4)	mg/kg	參考US EPA 5021方法, 以氣相層析/質譜儀檢測. / With reference to US EPA 5021 method. Analysis was performed by GC/MS.	1	n.d.	-
不完全鹵化氟溴化物 (HBFC)-121B4 (C <sub>2</sub> HFBr <sub>4</sub> )	mg/kg	參考US EPA 5021方法, 以氣相層析/質譜儀檢測. / With reference to US EPA 5021 method. Analysis was performed by GC/MS.	1	n.d.	-
不完全鹵化氟溴化物 (HBFC)-122B3 (C <sub>2</sub> HF <sub>2</sub> Br <sub>3</sub> )	mg/kg	參考US EPA 5021方法, 以氣相層析/質譜儀檢測. / With reference to US EPA 5021 method. Analysis was performed by GC/MS.	1	n.d.	-
不完全鹵化氟溴化物 (HBFC)-123B2 (C <sub>2</sub> HF <sub>3</sub> Br <sub>2</sub> )	mg/kg	參考US EPA 5021方法, 以氣相層析/質譜儀檢測. / With reference to US EPA 5021 method. Analysis was performed by GC/MS.	1	n.d.	-

This document is issued by the Company subject to its General Conditions of Service printed overleaf, available on request or accessible at <http://www.sgs.com/en/Terms-and-Conditions.aspx> and, for electronic format documents, subject to Terms and Conditions for Electronic Documents at <http://www.sgs.com/en/Terms-and-Conditions/Termse-Documents.aspx>. Attention is drawn to the limitation of liability, indemnification and jurisdiction issues defined therein. Any holder of this document is advised that information contained hereon reflects the Company's findings at the time of its intervention only and within the limits of client's instruction, if any. The Company's sole responsibility is to its Client and this document does not exonerate parties to a transaction from exercising all their rights and obligations under the transaction documents. This document cannot be reproduced, except in full, without prior written approval of the Company. Any unauthorized alteration, forgery or falsification of the content or appearance of this document is unlawful and offenders may be prosecuted to the fullest extent of the law. Unless otherwise stated the results shown in this test report refer only to the sample(s) tested.

# 測試報告

# Test Report

號碼(No.) : CE/2015/20347

日期(Date) : 2015/02/16

頁數(Page): 29 of 65



南亞塑膠工業股份有限公司(台灣) / NAN YA PLASTICS CORPORATION (TAIWAN)

(南亞電子材料(昆山)有限公司 / NAN YA ELECTRONIC MATERIALS (KUNSHAN) CORP., LTD)

(南亞電子材料(惠州)有限公司 / NAN YA ELECTRONIC MATERIALS (HUIZHOU) CORP., LTD)

台灣台北市敦化北路201號 / 201 TUNG HWA NORTH ROAD, TAIPEI, TAIWAN

(江蘇省昆山市長江南路201號 / 201 CHANG JIANG ROAD(S) KUNSHAN ECONOMIC & TECHNICAL DEVELOPMENT ZONE, JIANG SU)

(廣東省惠州市博羅縣石灣鎮永石大道 / YONGSHI BOULEVARD SHIWAN TOWN BOLUO COUNTY HUIZHOU CITY GUANG DONG)

測試項目 (Test Items)	單位 (Unit)	測試方法 (Method)	方法偵測 極限值 (MDL)	結果 (Result)	限值 (Limit)
				No.1	
不完全鹵化氟溴化物 (HBFC)-124B1 (C2HF4Br)	mg/kg	參考US EPA 5021方法, 以氣相層析/質譜儀檢測. / With reference to US EPA 5021 method. Analysis was performed by GC/MS.	1	n.d.	-
不完全鹵化氟溴化物 (HBFC)-131B3 (C2H2FBr3)	mg/kg	參考US EPA 5021方法, 以氣相層析/質譜儀檢測. / With reference to US EPA 5021 method. Analysis was performed by GC/MS.	1	n.d.	-
不完全鹵化氟溴化物 (HBFC)-132B2 (C2H2F2Br2)	mg/kg	參考US EPA 5021方法, 以氣相層析/質譜儀檢測. / With reference to US EPA 5021 method. Analysis was performed by GC/MS.	1	n.d.	-
不完全鹵化氟溴化物 (HBFC)-133B1 (C2H2F3Br)	mg/kg	參考US EPA 5021方法, 以氣相層析/質譜儀檢測. / With reference to US EPA 5021 method. Analysis was performed by GC/MS.	1	n.d.	-
不完全鹵化氟溴化物 (HBFC)-141B2 (C2H3FBr2)	mg/kg	參考US EPA 5021方法, 以氣相層析/質譜儀檢測. / With reference to US EPA 5021 method. Analysis was performed by GC/MS.	1	n.d.	-
不完全鹵化氟溴化物 (HBFC)-142B1 (C2H3F2Br)	mg/kg	參考US EPA 5021方法, 以氣相層析/質譜儀檢測. / With reference to US EPA 5021 method. Analysis was performed by GC/MS.	1	n.d.	-
不完全鹵化氟溴化物 (HBFC)-151B1 (C2H4FBr)	mg/kg	參考US EPA 5021方法, 以氣相層析/質譜儀檢測. / With reference to US EPA 5021 method. Analysis was performed by GC/MS.	1	n.d.	-

This document is issued by the Company subject to its General Conditions of Service printed overleaf, available on request or accessible at <http://www.sgs.com/en/Terms-and-Conditions.aspx> and, for electronic format documents, subject to Terms and Conditions for Electronic Documents at <http://www.sgs.com/en/Terms-and-Conditions/Termse-Documents.aspx>. Attention is drawn to the limitation of liability, indemnification and jurisdiction issues defined therein. Any holder of this document is advised that information contained hereon reflects the Company's findings at the time of its intervention only and within the limits of client's instruction, if any. The Company's sole responsibility is to its Client and this document does not exonerate parties to a transaction from exercising all their rights and obligations under the transaction documents. This document cannot be reproduced, except in full, without prior written approval of the Company. Any unauthorized alteration, forgery or falsification of the content or appearance of this document is unlawful and offenders may be prosecuted to the fullest extent of the law. Unless otherwise stated the results shown in this test report refer only to the sample(s) tested.

## 測試報告

號碼(No.) : CE/2015/20347

日期(Date) : 2015/02/16

頁數(Page): 30 of 65

## Test Report



南亞塑膠工業股份有限公司(台灣) / NAN YA PLASTICS CORPORATION (TAIWAN)

(南亞電子材料(昆山)有限公司 / NAN YA ELECTRONIC MATERIALS (KUNSHAN) CORP., LTD)

(南亞電子材料(惠州)有限公司 / NAN YA ELECTRONIC MATERIALS (HUIZHOU) CORP., LTD)

台灣台北市敦化北路201號 / 201 TUNG HWA NORTH ROAD, TAIPEI, TAIWAN

(江蘇省昆山市長江南路201號 / 201 CHANG JIANG ROAD(S) KUNSHAN ECONOMIC & TECHNICAL DEVELOPMENT ZONE, JIANG SU)

(廣東省惠州市博羅縣石灣鎮永石大道 / YONGSHI BOULEVARD SHIWAN TOWN BOLUO COUNTY HUIZHOU CITY GUANG DONG)

測試項目 (Test Items)	單位 (Unit)	測試方法 (Method)	方法偵測 極限值 (MDL)	結果 (Result)	限值 (Limit)
				No.1	
不完全鹵化氟溴化物 (HBFC)-221B6 (C3HFBr6)	mg/kg	參考US EPA 5021方法, 以氣相層析/質譜儀檢測. / With reference to US EPA 5021 method. Analysis was performed by GC/MS.	1	n.d.	-
不完全鹵化氟溴化物 (HBFC)-222B5 (C3HF2Br5)	mg/kg	參考US EPA 5021方法, 以氣相層析/質譜儀檢測. / With reference to US EPA 5021 method. Analysis was performed by GC/MS.	1	n.d.	-
不完全鹵化氟溴化物 (HBFC)-223B4 (C3HF3Br4)	mg/kg	參考US EPA 5021方法, 以氣相層析/質譜儀檢測. / With reference to US EPA 5021 method. Analysis was performed by GC/MS.	1	n.d.	-
不完全鹵化氟溴化物 (HBFC)-224B3 (C3HF4Br3)	mg/kg	參考US EPA 5021方法, 以氣相層析/質譜儀檢測. / With reference to US EPA 5021 method. Analysis was performed by GC/MS.	1	n.d.	-
不完全鹵化氟溴化物 (HBFC)-225B2 (C3HF5Br2)	mg/kg	參考US EPA 5021方法, 以氣相層析/質譜儀檢測. / With reference to US EPA 5021 method. Analysis was performed by GC/MS.	1	n.d.	-
不完全鹵化氟溴化物 (HBFC)-226B1 (C3HF6Br)	mg/kg	參考US EPA 5021方法, 以氣相層析/質譜儀檢測. / With reference to US EPA 5021 method. Analysis was performed by GC/MS.	1	n.d.	-
不完全鹵化氟溴化物 (HBFC)-231B5 (C3H2FBr5)	mg/kg	參考US EPA 5021方法, 以氣相層析/質譜儀檢測. / With reference to US EPA 5021 method. Analysis was performed by GC/MS.	1	n.d.	-

This document is issued by the Company subject to its General Conditions of Service printed overleaf, available on request or accessible at <http://www.sgs.com/en/Terms-and-Conditions.aspx> and, for electronic format documents, subject to Terms and Conditions for Electronic Documents at <http://www.sgs.com/en/Terms-and-Conditions/Termse-Document.aspx>. Attention is drawn to the limitation of liability, indemnification and jurisdiction issues defined therein. Any holder of this document is advised that information contained hereon reflects the Company's findings at the time of its intervention only and within the limits of client's instruction, if any. The Company's sole responsibility is to its Client and this document does not exonerate parties to a transaction from exercising all their rights and obligations under the transaction documents. This document cannot be reproduced, except in full, without prior written approval of the Company. Any unauthorized alteration, forgery or falsification of the content or appearance of this document is unlawful and offenders may be prosecuted to the fullest extent of the law. Unless otherwise stated the results shown in this test report refer only to the sample(s) tested.

## 測試報告

## Test Report

號碼(No.) : CE/2015/20347

日期(Date) : 2015/02/16

頁數(Page): 31 of 65



南亞塑膠工業股份有限公司(台灣) / NAN YA PLASTICS CORPORATION (TAIWAN)

(南亞電子材料(昆山)有限公司 / NAN YA ELECTRONIC MATERIALS (KUNSHAN) CORP., LTD)

(南亞電子材料(惠州)有限公司 / NAN YA ELECTRONIC MATERIALS (HUIZHOU) CORP., LTD)

台灣台北市敦化北路201號 / 201 TUNG HWA NORTH ROAD, TAIPEI, TAIWAN

(江蘇省昆山市長江南路201號 / 201 CHANG JIANG ROAD(S) KUNSHAN ECONOMIC & TECHNICAL DEVELOPMENT ZONE, JIANG SU)

(廣東省惠州市博羅縣石灣鎮永石大道 / YONGSHI BOULEVARD SHIWAN TOWN BOLUO COUNTY HUIZHOU CITY GUANG DONG)

測試項目 (Test Items)	單位 (Unit)	測試方法 (Method)	方法偵測 極限值 (MDL)	結果 (Result)	限值 (Limit)
				No.1	
不完全鹵化氟溴化物 (HBFC)-232B4 (C3H2F2Br4)	mg/kg	參考US EPA 5021方法, 以氣相層析/質譜儀檢測. / With reference to US EPA 5021 method. Analysis was performed by GC/MS.	1	n.d.	-
不完全鹵化氟溴化物 (HBFC)-233B3 (C3H2F3Br3)	mg/kg	參考US EPA 5021方法, 以氣相層析/質譜儀檢測. / With reference to US EPA 5021 method. Analysis was performed by GC/MS.	1	n.d.	-
不完全鹵化氟溴化物 (HBFC)-234B2 (C3H2F4Br2)	mg/kg	參考US EPA 5021方法, 以氣相層析/質譜儀檢測. / With reference to US EPA 5021 method. Analysis was performed by GC/MS.	1	n.d.	-
不完全鹵化氟溴化物 (HBFC)-235B1 (C3H2F5Br)	mg/kg	參考US EPA 5021方法, 以氣相層析/質譜儀檢測. / With reference to US EPA 5021 method. Analysis was performed by GC/MS.	1	n.d.	-
不完全鹵化氟溴化物 (HBFC)-241B4 (C3H3FBr4)	mg/kg	參考US EPA 5021方法, 以氣相層析/質譜儀檢測. / With reference to US EPA 5021 method. Analysis was performed by GC/MS.	1	n.d.	-
不完全鹵化氟溴化物 (HBFC)-242B3 (C3H3F2Br3)	mg/kg	參考US EPA 5021方法, 以氣相層析/質譜儀檢測. / With reference to US EPA 5021 method. Analysis was performed by GC/MS.	1	n.d.	-
不完全鹵化氟溴化物 (HBFC)-243B2 (C3H3F3Br2)	mg/kg	參考US EPA 5021方法, 以氣相層析/質譜儀檢測. / With reference to US EPA 5021 method. Analysis was performed by GC/MS.	1	n.d.	-

This document is issued by the Company subject to its General Conditions of Service printed overleaf, available on request or accessible at <http://www.sgs.com/en/Terms-and-Conditions.aspx> and, for electronic format documents, subject to Terms and Conditions for Electronic Documents at <http://www.sgs.com/en/Terms-and-Conditions/Termse-Document.aspx>. Attention is drawn to the limitation of liability, indemnification and jurisdiction issues defined therein. Any holder of this document is advised that information contained hereon reflects the Company's findings at the time of its intervention only and within the limits of client's instruction, if any. The Company's sole responsibility is to its Client and this document does not exonerate parties to a transaction from exercising all their rights and obligations under the transaction documents. This document cannot be reproduced, except in full, without prior written approval of the Company. Any unauthorized alteration, forgery or falsification of the content or appearance of this document is unlawful and offenders may be prosecuted to the fullest extent of the law. Unless otherwise stated the results shown in this test report refer only to the sample(s) tested.

# 測試報告

# Test Report

號碼(No.) : CE/2015/20347

日期(Date) : 2015/02/16

頁數(Page): 32 of 65



南亞塑膠工業股份有限公司(台灣) / NAN YA PLASTICS CORPORATION (TAIWAN)

(南亞電子材料(昆山)有限公司 / NAN YA ELECTRONIC MATERIALS (KUNSHAN) CORP., LTD)

(南亞電子材料(惠州)有限公司 / NAN YA ELECTRONIC MATERIALS (HUIZHOU) CORP., LTD)

台灣台北市敦化北路201號 / 201 TUNG HWA NORTH ROAD, TAIPEI, TAIWAN

(江蘇省昆山市長江南路201號 / 201 CHANG JIANG ROAD(S) KUNSHAN ECONOMIC & TECHNICAL DEVELOPMENT ZONE, JIANG SU)

(廣東省惠州市博羅縣石灣鎮永石大道 / YONGSHI BOULEVARD SHIWAN TOWN BOLUO COUNTY HUIZHOU CITY GUANG DONG)

測試項目 (Test Items)	單位 (Unit)	測試方法 (Method)	方法偵測 極限值 (MDL)	結果 (Result)	限值 (Limit)
				No.1	
不完全鹵化氟溴化物 (HBFC)-244B1 (C3H3F4Br)	mg/kg	參考US EPA 5021方法, 以氣相層析/質譜儀檢測. / With reference to US EPA 5021 method. Analysis was performed by GC/MS.	1	n.d.	-
不完全鹵化氟溴化物 (HBFC)-251B3 (C3H4FBr3)	mg/kg	參考US EPA 5021方法, 以氣相層析/質譜儀檢測. / With reference to US EPA 5021 method. Analysis was performed by GC/MS.	1	n.d.	-
不完全鹵化氟溴化物 (HBFC)-252B2 (C3H4F2Br2)	mg/kg	參考US EPA 5021方法, 以氣相層析/質譜儀檢測. / With reference to US EPA 5021 method. Analysis was performed by GC/MS.	1	n.d.	-
不完全鹵化氟溴化物 (HBFC)-253B1 (C3H4F3Br)	mg/kg	參考US EPA 5021方法, 以氣相層析/質譜儀檢測. / With reference to US EPA 5021 method. Analysis was performed by GC/MS.	1	n.d.	-
不完全鹵化氟溴化物 (HBFC)-261B2 (C3H5FBr2)	mg/kg	參考US EPA 5021方法, 以氣相層析/質譜儀檢測. / With reference to US EPA 5021 method. Analysis was performed by GC/MS.	1	n.d.	-
不完全鹵化氟溴化物 (HBFC)-262B1 (C3H5F2Br)	mg/kg	參考US EPA 5021方法, 以氣相層析/質譜儀檢測. / With reference to US EPA 5021 method. Analysis was performed by GC/MS.	1	n.d.	-
不完全鹵化氟溴化物 (HBFC)-271B1 (C3H6FBr)	mg/kg	參考US EPA 5021方法, 以氣相層析/質譜儀檢測. / With reference to US EPA 5021 method. Analysis was performed by GC/MS.	1	n.d.	-

This document is issued by the Company subject to its General Conditions of Service printed overleaf, available on request or accessible at <http://www.sgs.com/en/Terms-and-Conditions.aspx> and, for electronic format documents, subject to Terms and Conditions for Electronic Documents at <http://www.sgs.com/en/Terms-and-Conditions/Termse-Documents.aspx>. Attention is drawn to the limitation of liability, indemnification and jurisdiction issues defined therein. Any holder of this document is advised that information contained hereon reflects the Company's findings at the time of its intervention only and within the limits of client's instruction, if any. The Company's sole responsibility is to its Client and this document does not exonerate parties to a transaction from exercising all their rights and obligations under the transaction documents. This document cannot be reproduced, except in full, without prior written approval of the Company. Any unauthorized alteration, forgery or falsification of the content or appearance of this document is unlawful and offenders may be prosecuted to the fullest extent of the law. Unless otherwise stated the results shown in this test report refer only to the sample(s) tested.



# 測試報告

# Test Report

號碼(No.) : CE/2015/20347

日期(Date) : 2015/02/16

頁數(Page): 33 of 65



南亞塑膠工業股份有限公司(台灣) / NAN YA PLASTICS CORPORATION (TAIWAN)

(南亞電子材料(昆山)有限公司 / NAN YA ELECTRONIC MATERIALS (KUNSHAN) CORP., LTD)

(南亞電子材料(惠州)有限公司 / NAN YA ELECTRONIC MATERIALS (HUIZHOU) CORP., LTD)

台灣台北市敦化北路201號 / 201 TUNG HWA NORTH ROAD, TAIPEI, TAIWAN

(江蘇省昆山市市長江南路201號 / 201 CHANG JIANG ROAD(S) KUNSHAN ECONOMIC & TECHNICAL DEVELOPMENT ZONE, JIANG SU)

(廣東省惠州市博羅縣石灣鎮永石大道 / YONGSHI BOULEVARD SHIWAN TOWN BOLUO COUNTY HUIZHOU CITY GUANG DONG)

測試項目 (Test Items)	單位 (Unit)	測試方法 (Method)	方法偵測 極限值 (MDL)	結果 (Result)	限值 (Limit)
				No.1	
氯化碳氫化合物 / CHCs (Chlorinate hydrocarbon)					
1,1,1,2-四氯乙烷 / 1,1,1,2-Tetrachloroethane (CAS No.: 630-20-6)	mg/kg	參考US EPA 5021方法, 以氣相層析/質譜儀檢測. / With reference to US EPA 5021 method. Analysis was performed by GC/MS.	1	n.d.	-
1,1,1-三氯乙烷 / 1,1,1-Trichloroethane (CAS No.: 71-55-6)	mg/kg	參考US EPA 5021方法, 以氣相層析/質譜儀檢測. / With reference to US EPA 5021 method. Analysis was performed by GC/MS.	1	n.d.	-
1,1,2,2-四氯乙烷 / 1,1,2,2-Tetrachloroethane (CAS No.: 79-34-5)	mg/kg	參考US EPA 5021方法, 以氣相層析/質譜儀檢測. / With reference to US EPA 5021 method. Analysis was performed by GC/MS.	1	n.d.	-
1,1,2-三氯乙烷 / 1,1,2-Trichloroethane (CAS No.: 79-00-5)	mg/kg	參考US EPA 5021方法, 以氣相層析/質譜儀檢測. / With reference to US EPA 5021 method. Analysis was performed by GC/MS.	1	n.d.	-
1,1-二氯乙烷 / 1,1-Dichloroethane (CAS No.: 75-34-3)	mg/kg	參考US EPA 5021方法, 以氣相層析/質譜儀檢測. / With reference to US EPA 5021 method. Analysis was performed by GC/MS.	1	n.d.	-
1,1-二氯乙烯 / 1,1-Dichloroethene (CAS No.: 75-35-4)	mg/kg	參考US EPA 5021方法, 以氣相層析/質譜儀檢測. / With reference to US EPA 5021 method. Analysis was performed by GC/MS.	1	n.d.	-

This document is issued by the Company subject to its General Conditions of Service printed overleaf, available on request or accessible at <http://www.sgs.com/en/Terms-and-Conditions.aspx> and, for electronic format documents, subject to Terms and Conditions for Electronic Documents at <http://www.sgs.com/en/Terms-and-Conditions/Termse-Documents.aspx>. Attention is drawn to the limitation of liability, indemnification and jurisdiction issues defined therein. Any holder of this document is advised that information contained hereon reflects the Company's findings at the time of its intervention only and within the limits of client's instruction, if any. The Company's sole responsibility is to its Client and this document does not exonerate parties to a transaction from exercising all their rights and obligations under the transaction documents. This document cannot be reproduced, except in full, without prior written approval of the Company. Any unauthorized alteration, forgery or falsification of the content or appearance of this document is unlawful and offenders may be prosecuted to the fullest extent of the law. Unless otherwise stated the results shown in this test report refer only to the sample(s) tested.

# 測試報告

# Test Report

號碼(No.) : CE/2015/20347

日期(Date) : 2015/02/16

頁數(Page): 34 of 65



南亞塑膠工業股份有限公司(台灣) / NAN YA PLASTICS CORPORATION (TAIWAN)

(南亞電子材料(昆山)有限公司 / NAN YA ELECTRONIC MATERIALS (KUNSHAN) CORP., LTD)

(南亞電子材料(惠州)有限公司 / NAN YA ELECTRONIC MATERIALS (HUIZHOU) CORP., LTD)

台灣台北市敦化北路201號 / 201 TUNG HWA NORTH ROAD, TAIPEI, TAIWAN

(江蘇省昆山市長江南路201號 / 201 CHANG JIANG ROAD(S) KUNSHAN ECONOMIC & TECHNICAL DEVELOPMENT ZONE, JIANG SU)

(廣東省惠州市博羅縣石灣鎮永石大道 / YONGSHI BOULEVARD SHIWAN TOWN BOLUO COUNTY HUIZHOU CITY GUANG DONG)

測試項目 (Test Items)	單位 (Unit)	測試方法 (Method)	方法偵測 極限值 (MDL)	結果 (Result)	限值 (Limit)
				No.1	
1,1-二氯丙烯 / 1,1-Dichloropropene (CAS No.: 563-58-6)	mg/kg	參考US EPA 5021方法, 以氣相層析/質譜儀檢測. / With reference to US EPA 5021 method. Analysis was performed by GC/MS.	1	n.d.	-
1,2,3-三氯丙烷 / 1,2,3-Trichloropropane (CAS No.: 96-18-4)	mg/kg	參考US EPA 5021方法, 以氣相層析/質譜儀檢測. / With reference to US EPA 5021 method. Analysis was performed by GC/MS.	1	n.d.	-
1,2-二氯乙烷 / 1,2-Dichloroethane (CAS No.: 107-06-2)	mg/kg	參考US EPA 5021方法, 以氣相層析/質譜儀檢測. / With reference to US EPA 5021 method. Analysis was performed by GC/MS.	1	n.d.	-
1,2-二氯丙烷 / 1,2-Dichloropropane (CAS No.: 78-87-5)	mg/kg	參考US EPA 5021方法, 以氣相層析/質譜儀檢測. / With reference to US EPA 5021 method. Analysis was performed by GC/MS.	1	n.d.	-
1,3-二氯丙烷 / 1,3-Dichloropropane (CAS No.: 142-28-9)	mg/kg	參考US EPA 5021方法, 以氣相層析/質譜儀檢測. / With reference to US EPA 5021 method. Analysis was performed by GC/MS.	1	n.d.	-
2,2-二氯丙烷 / 2,2-Dichloropropane (CAS No.: 594-20-7)	mg/kg	參考US EPA 5021方法, 以氣相層析/質譜儀檢測. / With reference to US EPA 5021 method. Analysis was performed by GC/MS.	1	n.d.	-
四氯甲烷 (四氯化碳) / Carbon tetrachloride (CAS No.: 56-23-5)	mg/kg	參考US EPA 5021方法, 以氣相層析/質譜儀檢測. / With reference to US EPA 5021 method. Analysis was performed by GC/MS.	1	n.d.	-

This document is issued by the Company subject to its General Conditions of Service printed overleaf, available on request or accessible at <http://www.sgs.com/en/Terms-and-Conditions.aspx> and, for electronic format documents, subject to Terms and Conditions for Electronic Documents at <http://www.sgs.com/en/Terms-and-Conditions/Termse-Document.aspx>. Attention is drawn to the limitation of liability, indemnification and jurisdiction issues defined therein. Any holder of this document is advised that information contained hereon reflects the Company's findings at the time of its intervention only and within the limits of client's instruction, if any. The Company's sole responsibility is to its Client and this document does not exonerate parties to a transaction from exercising all their rights and obligations under the transaction documents. This document cannot be reproduced, except in full, without prior written approval of the Company. Any unauthorized alteration, forgery or falsification of the content or appearance of this document is unlawful and offenders may be prosecuted to the fullest extent of the law. Unless otherwise stated the results shown in this test report refer only to the sample(s) tested.

# 測試報告

# Test Report

號碼(No.) : CE/2015/20347

日期(Date) : 2015/02/16

頁數(Page): 35 of 65



南亞塑膠工業股份有限公司(台灣) / NAN YA PLASTICS CORPORATION (TAIWAN)

(南亞電子材料(昆山)有限公司 / NAN YA ELECTRONIC MATERIALS (KUNSHAN) CORP., LTD)

(南亞電子材料(惠州)有限公司 / NAN YA ELECTRONIC MATERIALS (HUIZHOU) CORP., LTD)

台灣台北市敦化北路201號 / 201 TUNG HWA NORTH ROAD, TAIPEI, TAIWAN

(江蘇省昆山市長江南路201號 / 201 CHANG JIANG ROAD(S) KUNSHAN ECONOMIC & TECHNICAL DEVELOPMENT ZONE, JIANG SU)

(廣東省惠州市博羅縣石灣鎮永石大道 / YONGSHI BOULEVARD SHIWAN TOWN BOLUO COUNTY HUIZHOU CITY GUANG DONG)

測試項目 (Test Items)	單位 (Unit)	測試方法 (Method)	方法偵測 極限值 (MDL)	結果 (Result)	限值 (Limit)
				No.1	
氯乙烷 / Chloroethane (CAS No.: 75-00-3)	mg/kg	參考US EPA 5021方法, 以氣相層析/質譜儀檢測. / With reference to US EPA 5021 method. Analysis was performed by GC/MS.	1	n.d.	-
氯仿 / Chloroform (CAS No.: 67-66-3)	mg/kg	參考US EPA 5021方法, 以氣相層析/質譜儀檢測. / With reference to US EPA 5021 method. Analysis was performed by GC/MS.	1	n.d.	-
氯甲烷 / Chloromethane (CAS No.: 74-87-3)	mg/kg	參考US EPA 5021方法, 以氣相層析/質譜儀檢測. / With reference to US EPA 5021 method. Analysis was performed by GC/MS.	1	n.d.	-
順-1,2-二氯乙烯 / cis-1,2-Dichloroethene (CAS No.: 156-59-2)	mg/kg	參考US EPA 5021方法, 以氣相層析/質譜儀檢測. / With reference to US EPA 5021 method. Analysis was performed by GC/MS.	1	n.d.	-
順-1,3-二氯丙烯 / cis-1,3-Dichloropropene (CAS No.: 10061-01-5)	mg/kg	參考US EPA 5021方法, 以氣相層析/質譜儀檢測. / With reference to US EPA 5021 method. Analysis was performed by GC/MS.	1	n.d.	-
六氯丁二烯 / Hexachlorobutadiene (CAS No.: 87-68-3)	mg/kg	參考US EPA 5021方法, 以氣相層析/質譜儀檢測. / With reference to US EPA 5021 method. Analysis was performed by GC/MS.	1	n.d.	-
二氯甲烷 / Dichloromethane (CAS No.: 75-09-2)	mg/kg	參考US EPA 5021方法, 以氣相層析/質譜儀檢測. / With reference to US EPA 5021 method. Analysis was performed by GC/MS.	1	n.d.	-

This document is issued by the Company subject to its General Conditions of Service printed overleaf, available on request or accessible at <http://www.sgs.com/en/Terms-and-Conditions.aspx> and, for electronic format documents, subject to Terms and Conditions for Electronic Documents at <http://www.sgs.com/en/Terms-and-Conditions/Termse-Document.aspx>. Attention is drawn to the limitation of liability, indemnification and jurisdiction issues defined therein. Any holder of this document is advised that information contained hereon reflects the Company's findings at the time of its intervention only and within the limits of client's instruction, if any. The Company's sole responsibility is to its Client and this document does not exonerate parties to a transaction from exercising all their rights and obligations under the transaction documents. This document cannot be reproduced, except in full, without prior written approval of the Company. Any unauthorized alteration, forgery or falsification of the content or appearance of this document is unlawful and offenders may be prosecuted to the fullest extent of the law. Unless otherwise stated the results shown in this test report refer only to the sample(s) tested.

## 測試報告

## Test Report

號碼(No.) : CE/2015/20347

日期(Date) : 2015/02/16

頁數(Page): 36 of 65



南亞塑膠工業股份有限公司(台灣) / NAN YA PLASTICS CORPORATION (TAIWAN)

(南亞電子材料(昆山)有限公司 / NAN YA ELECTRONIC MATERIALS (KUNSHAN) CORP., LTD)

(南亞電子材料(惠州)有限公司 / NAN YA ELECTRONIC MATERIALS (HUIZHOU) CORP., LTD)

台灣台北市敦化北路201號 / 201 TUNG HWA NORTH ROAD, TAIPEI, TAIWAN

(江蘇省昆山市長江南路201號 / 201 CHANG JIANG ROAD(S) KUNSHAN ECONOMIC & TECHNICAL DEVELOPMENT ZONE, JIANG SU)

(廣東省惠州市博羅縣石灣鎮永石大道 / YONGSHI BOULEVARD SHIWAN TOWN BOLUO COUNTY HUIZHOU CITY GUANG DONG)

測試項目 (Test Items)	單位 (Unit)	測試方法 (Method)	方法偵測 極限值 (MDL)	結果 (Result)	限值 (Limit)
				No.1	
四氯乙烯 / Tetrachloroethene (CAS No.: 127-18-4)	mg/kg	參考US EPA 5021方法, 以氣相層析/質譜儀檢測. / With reference to US EPA 5021 method. Analysis was performed by GC/MS.	1	n.d.	-
反-1,2-二氯乙烯 / trans-1,2-Dichloroethene (CAS No.: 156-60-5)	mg/kg	參考US EPA 5021方法, 以氣相層析/質譜儀檢測. / With reference to US EPA 5021 method. Analysis was performed by GC/MS.	1	n.d.	-
反-1,3-二氯丙烯 / trans-1,3-Dichloropropene (CAS No.: 10061-02-6)	mg/kg	參考US EPA 5021方法, 以氣相層析/質譜儀檢測. / With reference to US EPA 5021 method. Analysis was performed by GC/MS.	1	n.d.	-
三氯乙烯 / Trichloroethylene (CAS No.: 79-01-6)	mg/kg	參考US EPA 5021方法, 以氣相層析/質譜儀檢測. / With reference to US EPA 5021 method. Analysis was performed by GC/MS.	1	n.d.	-
<b>石棉 / Asbestos</b>					
陽起石綿 / Actinolite (CAS No.: 77536-66-4)	%	參考EPA 600/R-93/116 / 立體顯微鏡 (SM), 分散染色式偏光顯微鏡 (DS-PLM)及X光繞射光譜分析法 (XRD) / With reference to EPA 600/R-93/116 method. Analysis was performed by Stereo Microscope (SM), Dispersion Staining Polarized Light Microscope (DS-PLM) and X-ray Diffraction Spectrometer (XRD).	-	Negative	-
鐵石綿(褐石綿) / Amosite (CAS No.: 12172-73-5)			-	Negative	-
斜方角閃石綿 / Anthophyllite (CAS No.: 77536-67-5)			-	Negative	-
溫石綿(白石綿) / Chrysotile (CAS No.: 12001-29-5)			-	Negative	-
青石綿 / Crocidolite (CAS No.: 12001-28-4)			-	Negative	-
透閃石綿 / Tremolite (CAS No.: 77536-68-6)			-	Negative	-

This document is issued by the Company subject to its General Conditions of Service printed overleaf, available on request or accessible at <http://www.sgs.com/en/Terms-and-Conditions.aspx> and, for electronic format documents, subject to Terms and Conditions for Electronic Documents at <http://www.sgs.com/en/Terms-and-Conditions/Termse-Document.aspx>. Attention is drawn to the limitation of liability, indemnification and jurisdiction issues defined therein. Any holder of this document is advised that information contained hereon reflects the Company's findings at the time of its intervention only and within the limits of client's instruction, if any. The Company's sole responsibility is to its Client and this document does not exonerate parties to a transaction from exercising all their rights and obligations under the transaction documents. This document cannot be reproduced, except in full, without prior written approval of the Company. Any unauthorized alteration, forgery or falsification of the content or appearance of this document is unlawful and offenders may be prosecuted to the fullest extent of the law. Unless otherwise stated the results shown in this test report refer only to the sample(s) tested.

# 測試報告

# Test Report

號碼(No.) : CE/2015/20347

日期(Date) : 2015/02/16

頁數(Page): 37 of 65



南亞塑膠工業股份有限公司(台灣) / NAN YA PLASTICS CORPORATION (TAIWAN)

(南亞電子材料(昆山)有限公司 / NAN YA ELECTRONIC MATERIALS (KUNSHAN) CORP., LTD)

(南亞電子材料(惠州)有限公司 / NAN YA ELECTRONIC MATERIALS (HUIZHOU) CORP., LTD)

台灣台北市敦化北路201號 / 201 TUNG HWA NORTH ROAD, TAIPEI, TAIWAN

(江蘇省昆山市長江南路201號 / 201 CHANG JIANG ROAD(S) KUNSHAN ECONOMIC & TECHNICAL DEVELOPMENT ZONE, JIANG SU)

(廣東省惠州市博羅縣石灣鎮永石大道 / YONGSHI BOULEVARD SHIWAN TOWN BOLUO COUNTY HUIZHOU CITY GUANG DONG)

測試項目 (Test Items)	單位 (Unit)	測試方法 (Method)	方法偵測 極限值 (MDL)	結果 (Result)	限值 (Limit)
				No.1	
多環芳香烴 / Polynuclear Aromatic Hydrocarbons (PAHs)					
芘 / Acenaphthene (CAS No.: 83-32-9)	mg/kg	參考ZLS standard ZEK 01.4-08方法, 以氣相層析/質譜儀檢測. / With reference to ZLS standard ZEK 01.4-08 method. Analysis was performed by GC/MS.	0.2	n.d.	-
芴 / Acenaphthylene (CAS No.: 208-96-8)	mg/kg		0.2	n.d.	-
蔥 / Anthracene (CAS No.: 120-12-7)	mg/kg		0.2	n.d.	-
苯駢蔥 / Benzo[a]anthracene (CAS No.: 56-55-3)	mg/kg		0.2	n.d.	-
苯駢(a)芘 / Benzo[a]pyrene (CAS No.: 50-32-8)	mg/kg		0.2	n.d.	-
苯(b)苯駢芴 / Benzo[b]fluoranthene (CAS No.: 205-99-2)	mg/kg		0.2	n.d.	-
苯駢芘 / Benzo[g,h,i]perylene (CAS No.: 191-24-2)	mg/kg		0.2	n.d.	-
苯(k)苯駢芴 / Benzo[k]fluoranthene (CAS No.: 207-08-9)	mg/kg		0.2	n.d.	-
Chrysene (CAS No.: 218-01-9)	mg/kg		0.2	n.d.	-
二苯駢蔥 / Dibenzo[a,h]anthracene (CAS No.: 53-70-3)	mg/kg		0.2	n.d.	-
苯駢芴 / Fluoranthene (CAS No.: 206-44-0)	mg/kg		0.2	n.d.	-
芴 / Fluorene (CAS No.: 86-73-7)	mg/kg		0.2	n.d.	-
茚酮芘 / Indeno[1,2,3-c,d] pyrene (CAS No.: 193-39-5)	mg/kg		0.2	n.d.	-
萘 / Naphthalene (CAS No.: 91-20-3)	mg/kg		0.2	n.d.	-
菲 / Phenanthrene (CAS No.: 85-01-8)	mg/kg		0.2	n.d.	-
芘 / Pyrene (CAS No.: 129-00-0)	mg/kg		0.2	n.d.	-
苯(j)苯駢芴 / Benzo[j]fluoranthene (CAS No.: 205-82-3)	mg/kg		0.2	n.d.	-
苯駢(e)芘 / Benzo[e]pyrene (CAS No.: 192-97-2)	mg/kg		0.2	n.d.	-
多環芳香烴18項總和 / Sum of 18 PAHs	mg/kg		-	n.d.	-

This document is issued by the Company subject to its General Conditions of Service printed overleaf, available on request or accessible at <http://www.sgs.com/en/Terms-and-Conditions.aspx> and, for electronic format documents, subject to Terms and Conditions for Electronic Documents at <http://www.sgs.com/en/Terms-and-Conditions/Termse-Documents.aspx>. Attention is drawn to the limitation of liability, indemnification and jurisdiction issues defined therein. Any holder of this document is advised that information contained hereon reflects the Company's findings at the time of its intervention only and within the limits of client's instruction, if any. The Company's sole responsibility is to its Client and this document does not exonerate parties to a transaction from exercising all their rights and obligations under the transaction documents. This document cannot be reproduced, except in full, without prior written approval of the Company. Any unauthorized alteration, forgery or falsification of the content or appearance of this document is unlawful and offenders may be prosecuted to the fullest extent of the law. Unless otherwise stated the results shown in this test report refer only to the sample(s) tested.



## 測試報告

號碼(No.) : CE/2015/20347

日期(Date) : 2015/02/16

頁數(Page): 38 of 65

## Test Report



南亞塑膠工業股份有限公司(台灣) / NAN YA PLASTICS CORPORATION (TAIWAN)

(南亞電子材料(昆山)有限公司 / NAN YA ELECTRONIC MATERIALS (KUNSHAN) CORP., LTD)

(南亞電子材料(惠州)有限公司 / NAN YA ELECTRONIC MATERIALS (HUIZHOU) CORP., LTD)

台灣台北市敦化北路201號 / 201 TUNG HWA NORTH ROAD, TAIPEI, TAIWAN

(江蘇省昆山市長江南路201號 / 201 CHANG JIANG ROAD(S) KUNSHAN ECONOMIC & TECHNICAL DEVELOPMENT ZONE, JIANG SU)

(廣東省惠州市博羅縣石灣鎮永石大道 / YONGSHI BOULEVARD SHIWAN TOWN BOLUO COUNTY HUIZHOU CITY GUANG DONG)

### 備註(Note) :

1. mg/kg = ppm ; 0.1wt% = 1000ppm
2. n.d. = Not Detected (未檢出)
3. MDL = Method Detection Limit (方法偵測極限值)
4. "-" = Not Regulated (無規格值)
5. "\*" = Qualitative analysis (No Unit) 定性分析(無單位)
6. Negative = Undetectable 陰性(未偵測到); Positive = Detectable 陽性(已偵測到)
7. 石綿定性分析試驗範圍: <0.1%~100%, 石綿鑑定的判定基準是以檢出含有石綿纖維為『Positive』, 未檢出石綿纖維為『Negative』。 / Testing range of asbestos qualitative analysis is from less than 0.1% to 100%. The judgment criterion: asbestos fibers being found is shown as "Positive"; asbestos fibers not being found is shown as "Negative".
8. \*\*\*: 該物質是由三丁基錫, 砷, 硼或鉍各別之測試結果計算得知. 其MDL是針對三丁基錫, 砷, 硼或鉍之評估. (The substance was calculated by the test results of Tributyl Tin, Arsenic, Boron or Beryllium respectively. The MDL was evaluated for Tributyl Tin, Arsenic, Boron or Beryllium respectively.)
9. (\*2): 水合硼酸鈉: 依照歐洲化學總署解釋以無水四硼酸二鈉數據作為代表(歐洲化學總署回信編號 Ref no.: INC 000000032519) / Tetraboron disodium heptaoxide, hydrate: Only anhydrous form of disodium tetraborate is relevant and considered according to ECHA explanation (Ref no.: INC 000000032519).
10. (※2): 被萃取出之溶出硼/砷是以感應耦合電漿原子發射光譜儀檢測得之. / The extracted soluble Boron / Arsenic are detected by ICP-AES.
11. 參數換算表 / Parameter Conversion Table :  
Please refer to [http://twap.sgs.com/sgsrsts/chn/download-REACH\\_tw.asp](http://twap.sgs.com/sgsrsts/chn/download-REACH_tw.asp)
12. 鉍青銅是一種主要成份為鉍及銅的合金, 當偵測不到總鉍含量時, 亦表示不含鉍青銅.  
(Since beryllium copper is a metal alloy of copper and beryllium and the test result is n.d. for beryllium, we can have conclusion that the beryllium copper is n.d..)

# 測試報告

# Test Report

號碼(No.) : CE/2015/20347

日期(Date) : 2015/02/16

頁數(Page): 39 of 65



南亞塑膠工業股份有限公司(台灣) / NAN YA PLASTICS CORPORATION (TAIWAN)

(南亞電子材料(昆山)有限公司 / NAN YA ELECTRONIC MATERIALS (KUNSHAN) CORP., LTD)

(南亞電子材料(惠州)有限公司 / NAN YA ELECTRONIC MATERIALS (HUIZHOU) CORP., LTD)

台灣台北市敦化北路201號 / 201 TUNG HWA NORTH ROAD, TAIPEI, TAIWAN

(江蘇省昆山市長江南路201號 / 201 CHANG JIANG ROAD(S) KUNSHAN ECONOMIC & TECHNICAL DEVELOPMENT ZONE, JIANG SU)

(廣東省惠州市博羅縣石灣鎮永石大道 / YONGSHI BOULEVARD SHIWAN TOWN BOLUO COUNTY HUIZHOU CITY GUANG DONG)

**PAHs參考資料(Reference information) :**

**依據ZEK 01.4-08之要求: 產品中最大值為**

**(Requirement of ZEK 01.4-08 : Restraining maximum values for products)**

項目 (Parameter)	第1類 (Category 1)	第2類 (Category 2)	第3類 (Category 3)
	意圖放入嘴內的材料或與36個月以下的幼兒皮膚有所接觸的玩具。 (Material indented to be put in the mouth or toys for children aged < 36 months with intended skin contact.)	可預見與皮膚接觸逾30秒(長期與皮膚接觸), 以及不屬於第1類的材料。 (Materials not falling under category 1 with foreseeable contact to skin for longer than 30 seconds (long-term skin contact).)	可預見與皮膚接觸短於30秒(短期與皮膚接觸), 以及不屬於第1類或第2類的材料。(Materials not falling under category 1 or 2 with foreseeable contact to skin for less than 30 seconds (short-term skin contact).)
苯駢(a)芘 Benzo[a]pyrene (mg/kg)	<MDL (<0.2)**	1	20
18項PAH總濃度 (Sum of 18 PAH) (mg/kg)*	<MDL (<0.2)**	10	200

**注意(Remark):**

\* = PAH濃度大於0.2mg/kg時, 則須計算PAH總濃度值。

(Only PAH substances >0.2 mg/kg are taken into account while calculating the sum of PAHs.)

\*\* = 最大濃度值超出等級一的限制, 但在等級二的濃度限制值內時, 可能需要確認測試材質是否適用於與食品或與口腔黏膜接觸, 並依照EN 1186 ff. and § 64 LFBG 80.30-1方法, 針對特定PAH的遷移測試進行測試。遷移測試的結論需依照食品規範評估。

(If the limits of category 1 are surpassed but the limits of category 2 still met, the confirmation of suitability of contact with foodstuff or the oral mucosa can be verified by an additional specific migration test of the PAH components according to EN 1186 ff. and § 64 LFBG 80.30-1. The results of the migration test shall be evaluated according to law criteria for foodstuff.)

This document is issued by the Company subject to its General Conditions of Service printed overleaf, available on request or accessible at <http://www.sgs.com/en/Terms-and-Conditions.aspx> and, for electronic format documents, subject to Terms and Conditions for Electronic Documents at <http://www.sgs.com/en/Terms-and-Conditions/Termse-Document.aspx>. Attention is drawn to the limitation of liability, indemnification and jurisdiction issues defined therein. Any holder of this document is advised that information contained hereon reflects the Company's findings at the time of its intervention only and within the limits of client's instruction, if any. The Company's sole responsibility is to its Client and this document does not exonerate parties to a transaction from exercising all their rights and obligations under the transaction documents. This document cannot be reproduced, except in full, without prior written approval of the Company. Any unauthorized alteration, forgery or falsification of the content or appearance of this document is unlawful and offenders may be prosecuted to the fullest extent of the law. Unless otherwise stated the results shown in this test report refer only to the sample(s) tested.

## 測試報告

號碼(No.) : CE/2015/20347

日期(Date) : 2015/02/16

頁數(Page): 40 of 65

## Test Report



南亞塑膠工業股份有限公司(台灣) / NAN YA PLASTICS CORPORATION (TAIWAN)

(南亞電子材料(昆山)有限公司 / NAN YA ELECTRONIC MATERIALS (KUNSHAN) CORP., LTD)

(南亞電子材料(惠州)有限公司 / NAN YA ELECTRONIC MATERIALS (HUIZHOU) CORP., LTD)

台灣台北市敦化北路201號 / 201 TUNG HWA NORTH ROAD, TAIPEI, TAIWAN

(江蘇省昆山昆山市長江南路201號 / 201 CHANG JIANG ROAD(S) KUNSHAN ECONOMIC & TECHNICAL DEVELOPMENT ZONE, JIANG SU)

(廣東省惠州市博羅縣石灣鎮永石大道 / YONGSHI BOULEVARD SHIWAN TOWN BOLUO COUNTY HUIZHOU CITY GUANG DONG)

### PFOS參考資訊(Reference Information) : 持久性有機污染物 POPs - (EU) 757/2010

PFOS濃度在物質或製備中不得超過0.001%(10ppm), 在半成品、成品或零部件中不得超過0.1%(1000ppm), 在紡織品或塗層材料中不得超過 $1\mu\text{g}/\text{m}^2$ 。

(Outlawing PFOS as substances or preparations in concentrations above 0.001% (10ppm), in semi-finished products or articles or parts at a level above 0.1%(1000ppm), in textiles or other coated materials above  $1\mu\text{g}/\text{m}^2$ .)

## 測試報告 Test Report

號碼(No.) : CE/2015/20347

日期(Date) : 2015/02/16

頁數(Page): 41 of 65



南亞塑膠工業股份有限公司(台灣) / NAN YA PLASTICS CORPORATION (TAIWAN)  
 (南亞電子材料(昆山)有限公司) / NAN YA ELECTRONIC MATERIALS (KUNSHAN) CORP., LTD)  
 (南亞電子材料(惠州)有限公司) / NAN YA ELECTRONIC MATERIALS (HUIZHOU) CORP., LTD)  
 台灣台北市敦化北路201號 / 201 TUNG HWA NORTH ROAD, TAIPEI, TAIWAN  
 (江蘇省昆山市市長江南路201號) / 201 CHANG JIANG ROAD(S) KUNSHAN ECONOMIC & TECHNICAL DEVELOPMENT ZONE, JIANG SU)  
 (廣東省惠州市博羅縣石灣鎮永石大道) / YONGSHI BOULEVARD SHIWAN TOWN BOLUO COUNTY HUIZHOU CITY GUANG DONG)

- 1) 根據以下的流程圖之條件, 樣品已完全溶解。(六價鉻測試方法除外) / These samples were dissolved totally by pre-conditioning method according to below flow chart. (Cr<sup>6+</sup> test method excluded)
- 2) 測試人員: 楊登偉 / Name of the person who made measurement: Climbgreat Yang
- 3) 測試負責人: 張啓興 / Name of the person in charge of measurement: Troy Chang

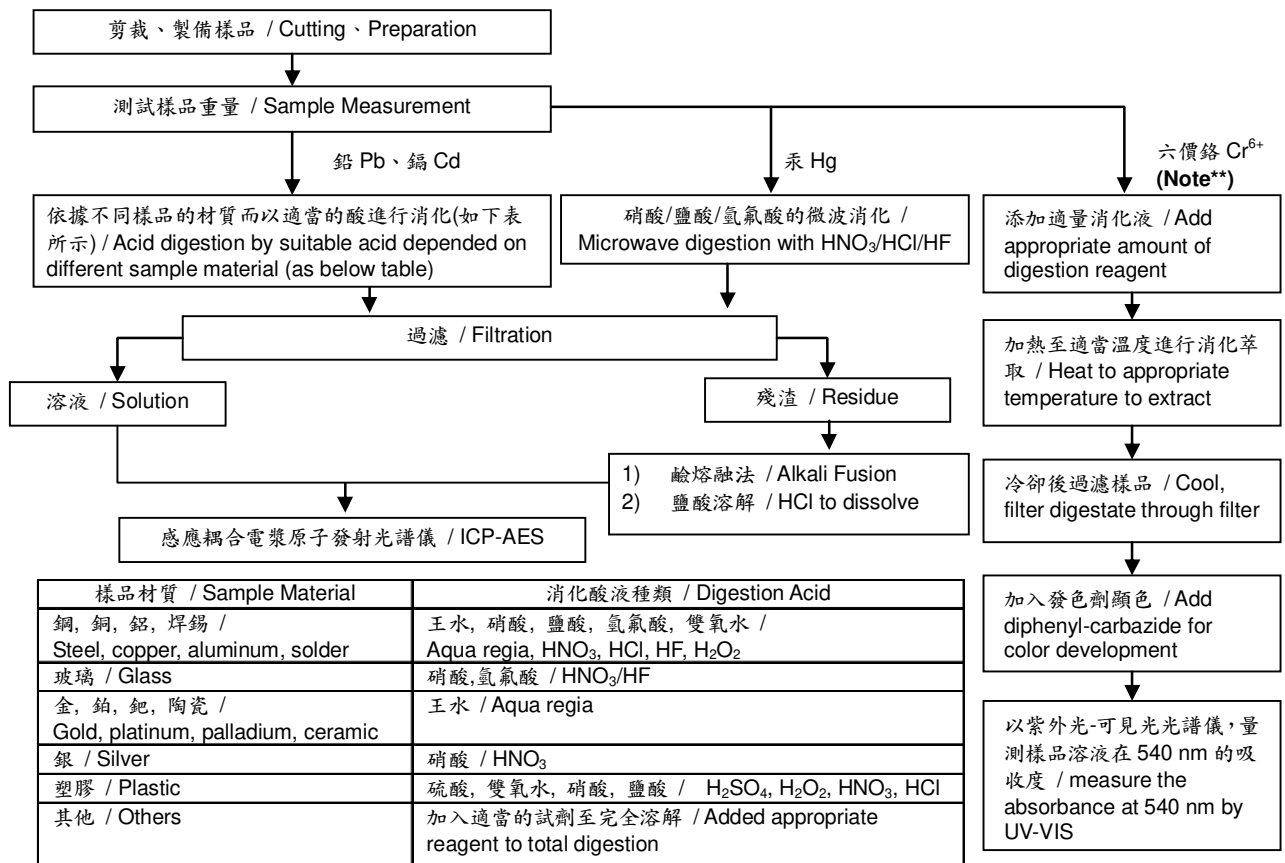

**Note\*\* (For IEC 62321)**

- (1) 針對非金屬材料加入鹼性消化液, 加熱至 90~95°C 萃取. / For non-metallic material, add alkaline digestion reagent and heat to 90~95°C.
- (2) 針對金屬材料加入純水, 加熱至沸騰萃取. / For metallic material, add pure water and heat to boiling.

## 測試報告

## Test Report

號碼(No.) : CE/2015/20347

日期(Date) : 2015/02/16

頁數(Page): 42 of 65



南亞塑膠工業股份有限公司(台灣) / NAN YA PLASTICS CORPORATION (TAIWAN)

(南亞電子材料(昆山)有限公司 / NAN YA ELECTRONIC MATERIALS (KUNSHAN) CORP., LTD)

(南亞電子材料(惠州)有限公司 / NAN YA ELECTRONIC MATERIALS (HUIZHOU) CORP., LTD)

台灣台北市敦化北路201號 / 201 TUNG HWA NORTH ROAD, TAIPEI, TAIWAN

(江蘇省昆山市市長江南路201號 / 201 CHANG JIANG ROAD(S) KUNSHAN ECONOMIC & TECHNICAL DEVELOPMENT ZONE, JIANG SU)

(廣東省惠州市博羅縣石灣鎮永石大道 / YONGSHI BOULEVARD SHIWAN TOWN BOLUO COUNTY HUIZHOU CITY GUANG DONG)

- 1) 根據以下的流程圖之條件，樣品已完全溶解。 / These samples were dissolved totally by pre-conditioning method according to below flow chart.
- 2) 測試人員：楊登偉 / Name of the person who made measurement: Climbgreat Yang
- 3) 測試負責人：張啓興 / Name of the person in charge of measurement: Troy Chang

### 元素以 ICP-AES 分析的消化流程圖

(Flow Chart of digestion for the elements analysis performed by ICP-AES)

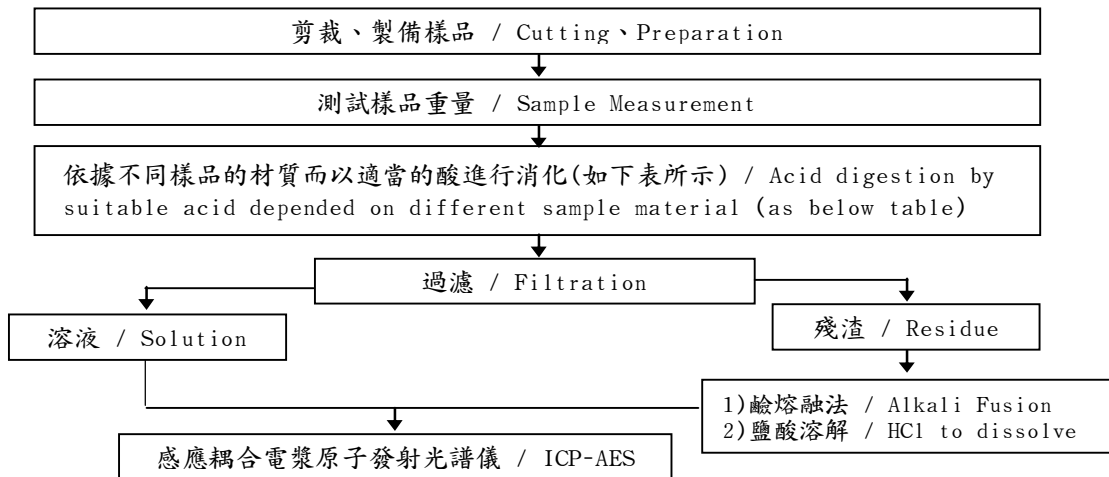

鋼,銅,鋁,焊錫 / Steel, copper, aluminum, solder	王水,硝酸,鹽酸,氫氟酸,雙氧水 / Aqua regia, HNO <sub>3</sub> , HCl, HF, H <sub>2</sub> O <sub>2</sub>
玻璃 / Glass	硝酸,氫氟酸 / HNO <sub>3</sub> /HF
金,鉑,鈀,陶瓷 / Gold, platinum, palladium, ceramic	王水 / Aqua regia
銀 / Silver	硝酸 / HNO <sub>3</sub>
塑膠 / Plastic	硫酸,雙氧水,硝酸,鹽酸 / H <sub>2</sub> SO <sub>4</sub> , H <sub>2</sub> O <sub>2</sub> , HNO <sub>3</sub> , HCl
其他 / Others	加入適當的試劑至完全溶解 / Added appropriate reagent to total digestion



## 測試報告

## Test Report

號碼(No.) : CE/2015/20347

日期(Date) : 2015/02/16

頁數(Page): 43 of 65



南亞塑膠工業股份有限公司(台灣) / NAN YA PLASTICS CORPORATION (TAIWAN)

(南亞電子材料(昆山)有限公司 / NAN YA ELECTRONIC MATERIALS (KUNSHAN) CORP., LTD)

(南亞電子材料(惠州)有限公司 / NAN YA ELECTRONIC MATERIALS (HUIZHOU) CORP., LTD)

台灣台北市敦化北路201號 / 201 TUNG HWA NORTH ROAD, TAIPEI, TAIWAN

(江蘇省昆山昆山市長江南路201號 / 201 CHANG JIANG ROAD(S) KUNSHAN ECONOMIC & TECHNICAL DEVELOPMENT ZONE, JIANG SU)

(廣東省惠州市博羅縣石灣鎮永石大道 / YONGSHI BOULEVARD SHIWAN TOWN BOLUO COUNTY HUIZHOU CITY GUANG DONG)

### 雙酚A分析流程圖 / Bisphenol A analytical flow chart

- 測試人員：林建宇 / Name of the person who made measurement: Roy Lin
- 測試負責人：張啓興 / Name of the person in charge of measurement: Troy Chang

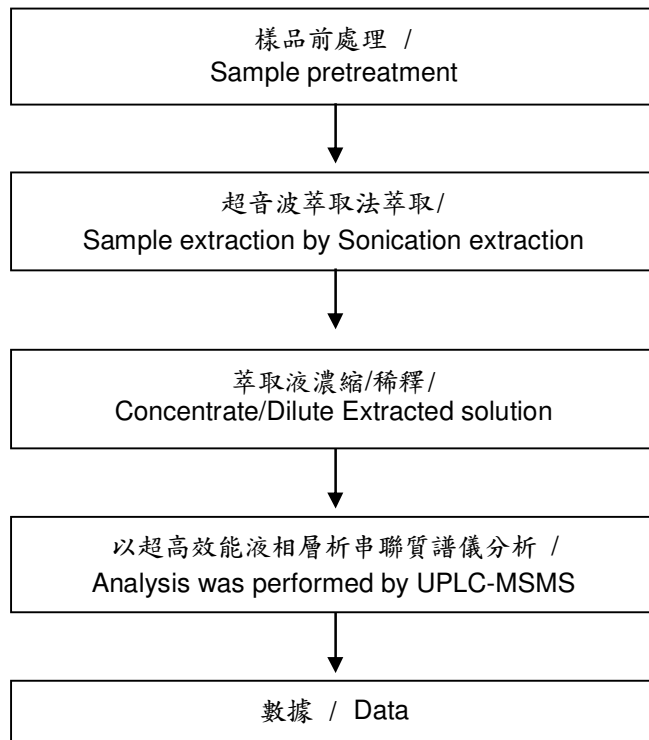

This document is issued by the Company subject to its General Conditions of Service printed overleaf, available on request or accessible at <http://www.sgs.com/en/Terms-and-Conditions.aspx> and, for electronic format documents, subject to Terms and Conditions for Electronic Documents at <http://www.sgs.com/en/Terms-and-Conditions/Termse-Documents.aspx>. Attention is drawn to the limitation of liability, indemnification and jurisdiction issues defined therein. Any holder of this document is advised that information contained hereon reflects the Company's findings at the time of its intervention only and within the limits of client's instruction, if any. The Company's sole responsibility is to its Client and this document does not exonerate parties to a transaction from exercising all their rights and obligations under the transaction documents. This document cannot be reproduced, except in full, without prior written approval of the Company. Any unauthorized alteration, forgery or falsification of the content or appearance of this document is unlawful and offenders may be prosecuted to the fullest extent of the law. Unless otherwise stated the results shown in this test report refer only to the sample(s) tested.

## 測試報告

## Test Report

號碼(No.) : CE/2015/20347

日期(Date) : 2015/02/16

頁數(Page): 44 of 65



南亞塑膠工業股份有限公司(台灣) / NAN YA PLASTICS CORPORATION (TAIWAN)

(南亞電子材料(昆山)有限公司 / NAN YA ELECTRONIC MATERIALS (KUNSHAN) CORP., LTD)

(南亞電子材料(惠州)有限公司 / NAN YA ELECTRONIC MATERIALS (HUIZHOU) CORP., LTD)

台灣台北市敦化北路201號 / 201 TUNG HWA NORTH ROAD, TAIPEI, TAIWAN

(江蘇省昆山昆山市長江南路201號 / 201 CHANG JIANG ROAD(S) KUNSHAN ECONOMIC & TECHNICAL DEVELOPMENT ZONE, JIANG SU)

(廣東省惠州市博羅縣石灣鎮永石大道 / YONGSHI BOULEVARD SHIWAN TOWN BOLUO COUNTY HUIZHOU CITY GUANG DONG)

### 四溴雙酚-A 分析流程圖 / TBBP-A analytical flow chart

- 測試人員：林建宇 / Name of the person who made measurement: Roy Lin
- 測試負責人：張啓興 / Name of the person in charge of measurement: Troy Chang

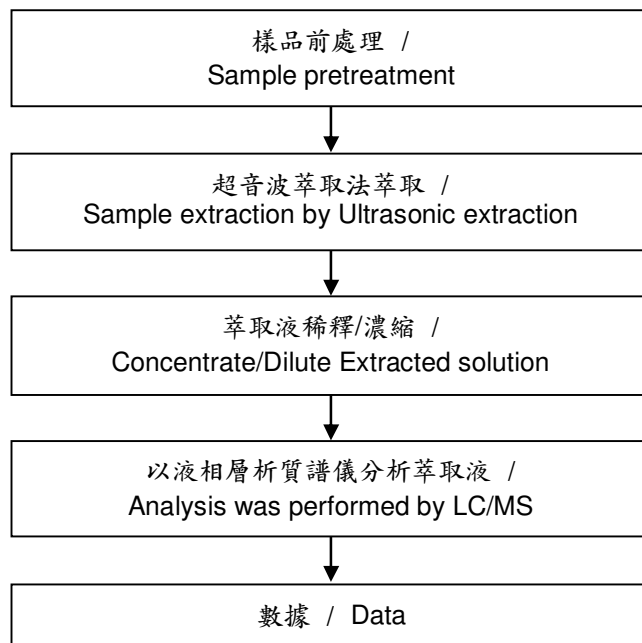

## 測試報告

## Test Report

號碼(No.) : CE/2015/20347

日期(Date) : 2015/02/16

頁數(Page): 45 of 65



南亞塑膠工業股份有限公司(台灣) / NAN YA PLASTICS CORPORATION (TAIWAN)

(南亞電子材料(昆山)有限公司 / NAN YA ELECTRONIC MATERIALS (KUNSHAN) CORP., LTD)

(南亞電子材料(惠州)有限公司 / NAN YA ELECTRONIC MATERIALS (HUIZHOU) CORP., LTD)

台灣台北市敦化北路201號 / 201 TUNG HWA NORTH ROAD, TAIPEI, TAIWAN

(江蘇省昆山昆山市長江南路201號 / 201 CHANG JIANG ROAD(S) KUNSHAN ECONOMIC & TECHNICAL DEVELOPMENT ZONE, JIANG SU)

(廣東省惠州市博羅縣石灣鎮永石大道 / YONGSHI BOULEVARD SHIWAN TOWN BOLUO COUNTY HUIZHOU CITY GUANG DONG)

### 多環芳香烴分析流程圖 / PAHs (Polynuclear Aromatic Hydrocarbons) analytical flow chart

- 測試人員：翁賜彬 / Name of the person who made measurement: Roman Wong
- 測試負責人：張啓興 / Name of the person in charge of measurement: Troy Chang

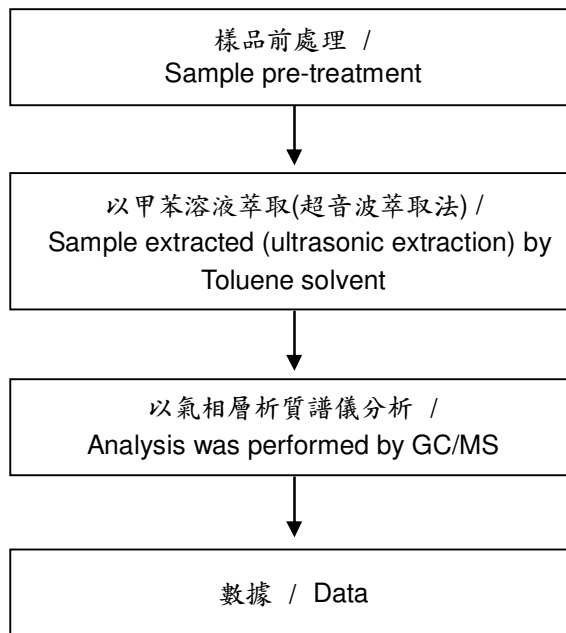

## 測試報告

## Test Report

號碼(No.) : CE/2015/20347

日期(Date) : 2015/02/16

頁數(Page): 46 of 65



南亞塑膠工業股份有限公司(台灣) / NAN YA PLASTICS CORPORATION (TAIWAN)

(南亞電子材料(昆山)有限公司 / NAN YA ELECTRONIC MATERIALS (KUNSHAN) CORP., LTD)

(南亞電子材料(惠州)有限公司 / NAN YA ELECTRONIC MATERIALS (HUIZHOU) CORP., LTD)

台灣台北市敦化北路201號 / 201 TUNG HWA NORTH ROAD, TAIPEI, TAIWAN

(江蘇省昆山昆山市長江南路201號 / 201 CHANG JIANG ROAD(S) KUNSHAN ECONOMIC & TECHNICAL DEVELOPMENT ZONE, JIANG SU)

(廣東省惠州市博羅縣石灣鎮永石大道 / YONGSHI BOULEVARD SHIWAN TOWN BOLUO COUNTY HUIZHOU CITY GUANG DONG)

### 乙二醇醚及其酯類分析流程圖 / Ethylene glycol ether analytical flow chart

- 測試人員：翁賜彬 / Name of the person who made measurement: Roman Wong
- 測試負責人：張啓興 / Name of the person in charge of measurement: Troy Chang

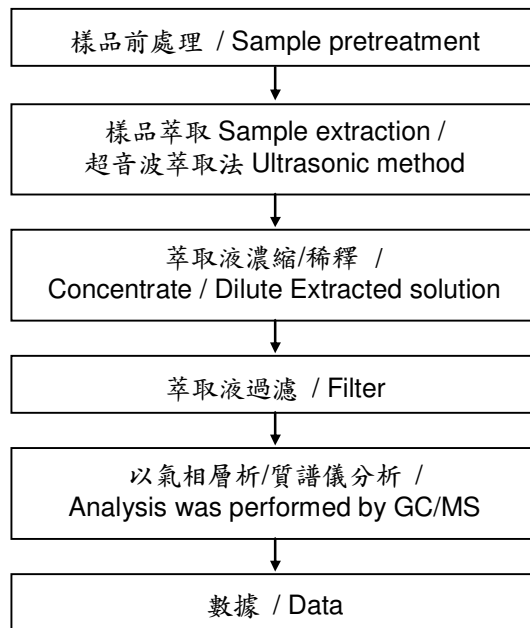

## 測試報告

## Test Report

號碼(No.) : CE/2015/20347

日期(Date) : 2015/02/16

頁數(Page): 47 of 65



南亞塑膠工業股份有限公司(台灣) / NAN YA PLASTICS CORPORATION (TAIWAN)

(南亞電子材料(昆山)有限公司 / NAN YA ELECTRONIC MATERIALS (KUNSHAN) CORP., LTD)

(南亞電子材料(惠州)有限公司 / NAN YA ELECTRONIC MATERIALS (HUIZHOU) CORP., LTD)

台灣台北市敦化北路201號 / 201 TUNG HWA NORTH ROAD, TAIPEI, TAIWAN

(江蘇省昆山昆山市長江南路201號 / 201 CHANG JIANG ROAD(S) KUNSHAN ECONOMIC & TECHNICAL DEVELOPMENT ZONE, JIANG SU)

(廣東省惠州市博羅縣石灣鎮永石大道 / YONGSHI BOULEVARD SHIWAN TOWN BOLUO COUNTY HUIZHOU CITY GUANG DONG)

### 可塑劑分析流程圖 / Analytical flow chart of phthalate content

- 測試人員：徐毓明 / Name of the person who made measurement: Andy Shu
- 測試負責人：張啓興 / Name of the person in charge of measurement: Troy Chang

#### 【測試方法/Test method: IEC 62321-8】

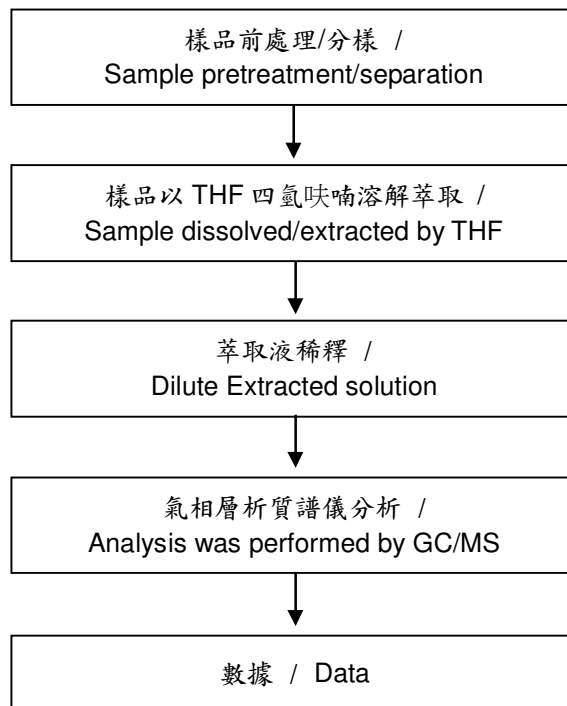



## 測試報告

## Test Report

號碼(No.) : CE/2015/20347

日期(Date) : 2015/02/16

頁數(Page): 48 of 65



南亞塑膠工業股份有限公司(台灣) / NAN YA PLASTICS CORPORATION (TAIWAN)

(南亞電子材料(昆山)有限公司 / NAN YA ELECTRONIC MATERIALS (KUNSHAN) CORP., LTD)

(南亞電子材料(惠州)有限公司 / NAN YA ELECTRONIC MATERIALS (HUIZHOU) CORP., LTD)

台灣台北市敦化北路201號 / 201 TUNG HWA NORTH ROAD, TAIPEI, TAIWAN

(江蘇省昆山昆山市長江南路201號 / 201 CHANG JIANG ROAD(S) KUNSHAN ECONOMIC & TECHNICAL DEVELOPMENT ZONE, JIANG SU)

(廣東省惠州市博羅縣石灣鎮永石大道 / YONGSHI BOULEVARD SHIWAN TOWN BOLUO COUNTY HUIZHOU CITY GUANG DONG)

### 可塑劑分析流程圖 / Analytical flow chart of phthalate content

- 測試人員：翁賜彬 / Name of the person who made measurement: Roman Wong
- 測試負責人：張啓興 / Name of the person in charge of measurement: Troy Chang

#### 【測試方法/Test method: EN 14372】

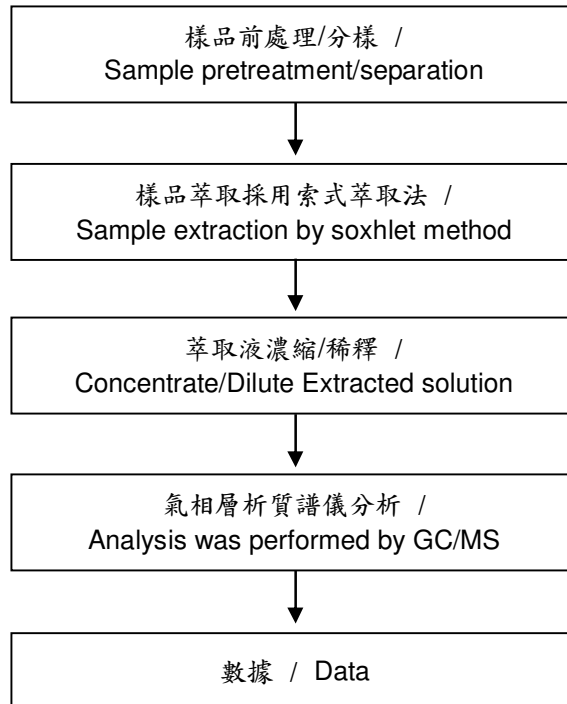

## 測試報告

## Test Report

號碼(No.) : CE/2015/20347

日期(Date) : 2015/02/16

頁數(Page): 49 of 65



南亞塑膠工業股份有限公司(台灣) / NAN YA PLASTICS CORPORATION (TAIWAN)

(南亞電子材料(昆山)有限公司 / NAN YA ELECTRONIC MATERIALS (KUNSHAN) CORP., LTD)

(南亞電子材料(惠州)有限公司 / NAN YA ELECTRONIC MATERIALS (HUIZHOU) CORP., LTD)

台灣台北市敦化北路201號 / 201 TUNG HWA NORTH ROAD, TAIPEI, TAIWAN

(江蘇省昆山昆山市長江南路201號 / 201 CHANG JIANG ROAD(S) KUNSHAN ECONOMIC & TECHNICAL DEVELOPMENT ZONE, JIANG SU)

(廣東省惠州市博羅縣石灣鎮永石大道 / YONGSHI BOULEVARD SHIWAN TOWN BOLUO COUNTY HUIZHOU CITY GUANG DONG)

### 鹵素分析流程圖 / Analytical flow chart of halogen content

- 測試人員：陳恩臻 / Name of the person who made measurement: Rita Chen
- 測試負責人：張啓興 / Name of the person in charge of measurement: Troy Chang

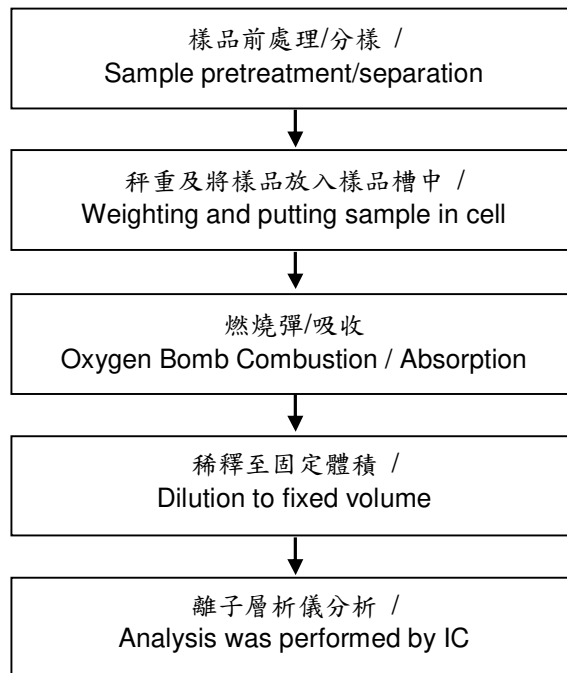

## 測試報告

## Test Report

號碼(No.) : CE/2015/20347

日期(Date) : 2015/02/16

頁數(Page): 50 of 65



南亞塑膠工業股份有限公司(台灣) / NAN YA PLASTICS CORPORATION (TAIWAN)

(南亞電子材料(昆山)有限公司 / NAN YA ELECTRONIC MATERIALS (KUNSHAN) CORP., LTD)

(南亞電子材料(惠州)有限公司 / NAN YA ELECTRONIC MATERIALS (HUIZHOU) CORP., LTD)

台灣台北市敦化北路201號 / 201 TUNG HWA NORTH ROAD, TAIPEI, TAIWAN

(江蘇省昆山昆山市長江南路201號 / 201 CHANG JIANG ROAD(S) KUNSHAN ECONOMIC & TECHNICAL DEVELOPMENT ZONE, JIANG SU)

(廣東省惠州市博羅縣石灣鎮永石大道 / YONGSHI BOULEVARD SHIWAN TOWN BOLUO COUNTY HUIZHOU CITY GUANG DONG)

### 六溴環十二烷分析流程圖 / HBCDD analytical flow chart

- 測試人員：翁賜彬 / Name of the person who made measurement: Roman Wong
- 測試負責人：張啓興 / Name of the person in charge of measurement: Troy Chang

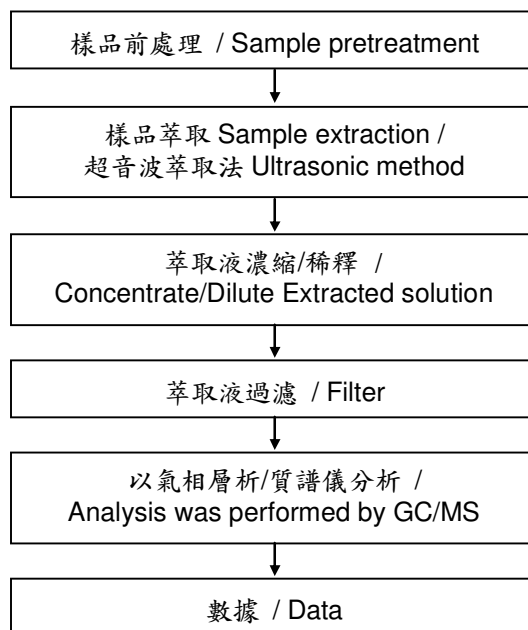

## 測試報告

## Test Report

號碼(No.) : CE/2015/20347

日期(Date) : 2015/02/16

頁數(Page): 51 of 65



南亞塑膠工業股份有限公司(台灣) / NAN YA PLASTICS CORPORATION (TAIWAN)

(南亞電子材料(昆山)有限公司 / NAN YA ELECTRONIC MATERIALS (KUNSHAN) CORP., LTD)

(南亞電子材料(惠州)有限公司 / NAN YA ELECTRONIC MATERIALS (HUIZHOU) CORP., LTD)

台灣台北市敦化北路201號 / 201 TUNG HWA NORTH ROAD, TAIPEI, TAIWAN

(江蘇省昆山昆山市長江南路201號 / 201 CHANG JIANG ROAD(S) KUNSHAN ECONOMIC & TECHNICAL DEVELOPMENT ZONE, JIANG SU)

(廣東省惠州市博羅縣石灣鎮永石大道 / YONGSHI BOULEVARD SHIWAN TOWN BOLUO COUNTY HUIZHOU CITY GUANG DONG)

### 富馬酸二甲酯分析流程圖 / Dimethyl Fumarate analytical flow chart

- 測試人員：翁賜彬 / Name of the person who made measurement: Roman Wong
- 測試負責人：張啓興 / Name of the person in charge of measurement: Troy Chang

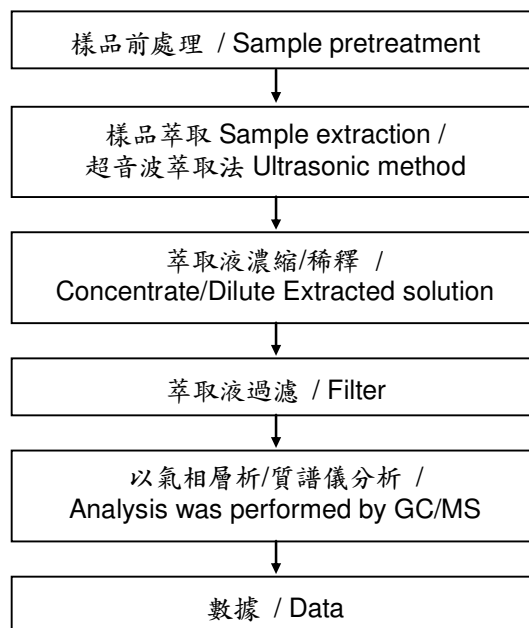

## 測試報告

## Test Report

號碼(No.) : CE/2015/20347

日期(Date) : 2015/02/16

頁數(Page): 52 of 65



南亞塑膠工業股份有限公司(台灣) / NAN YA PLASTICS CORPORATION (TAIWAN)

(南亞電子材料(昆山)有限公司 / NAN YA ELECTRONIC MATERIALS (KUNSHAN) CORP., LTD)

(南亞電子材料(惠州)有限公司 / NAN YA ELECTRONIC MATERIALS (HUIZHOU) CORP., LTD)

台灣台北市敦化北路201號 / 201 TUNG HWA NORTH ROAD, TAIPEI, TAIWAN

(江蘇省昆山昆山市長江南路201號 / 201 CHANG JIANG ROAD(S) KUNSHAN ECONOMIC & TECHNICAL DEVELOPMENT ZONE, JIANG SU)

(廣東省惠州市博羅縣石灣鎮永石大道 / YONGSHI BOULEVARD SHIWAN TOWN BOLUO COUNTY HUIZHOU CITY GUANG DONG)

### 揮發性有機化合物分析流程圖 / Analytical flow chart of volatile organic compounds (VOCs)

- 測試人員：吳椿景 / Name of the person who made measurement : Chun Wu
  - 測試負責人：陳新智 / Name of the person in charge of measurement : Shinjyh Chen
- 【參考方法(Reference method) : US EPA 5021】

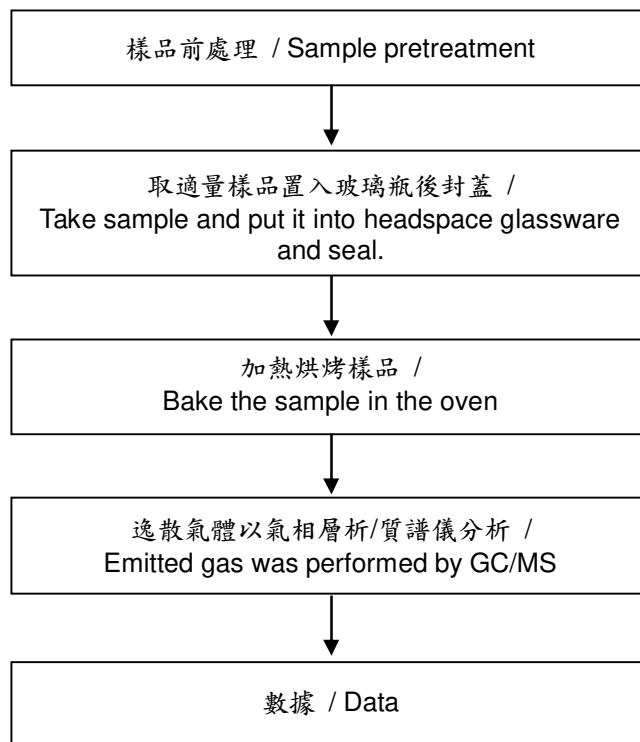



## 測試報告

## Test Report

號碼(No.) : CE/2015/20347

日期(Date) : 2015/02/16

頁數(Page): 53 of 65



南亞塑膠工業股份有限公司(台灣) / NAN YA PLASTICS CORPORATION (TAIWAN)

(南亞電子材料(昆山)有限公司 / NAN YA ELECTRONIC MATERIALS (KUNSHAN) CORP., LTD)

(南亞電子材料(惠州)有限公司 / NAN YA ELECTRONIC MATERIALS (HUIZHOU) CORP., LTD)

台灣台北市敦化北路201號 / 201 TUNG HWA NORTH ROAD, TAIPEI, TAIWAN

(江蘇省昆山昆山市長江南路201號 / 201 CHANG JIANG ROAD(S) KUNSHAN ECONOMIC & TECHNICAL DEVELOPMENT ZONE, JIANG SU)

(廣東省惠州市博羅縣石灣鎮永石大道 / YONGSHI BOULEVARD SHIWAN TOWN BOLUO COUNTY HUIZHOU CITY GUANG DONG)

### 二氯化鈷分析流程圖 / Analytical flow chart of Cobalt dichloride

- 測試人員：楊登偉 / Name of the person who made measurement: Climbgreat Yang
- 測試負責人：張啓興 / Name of the person in charge of measurement: Troy Chang

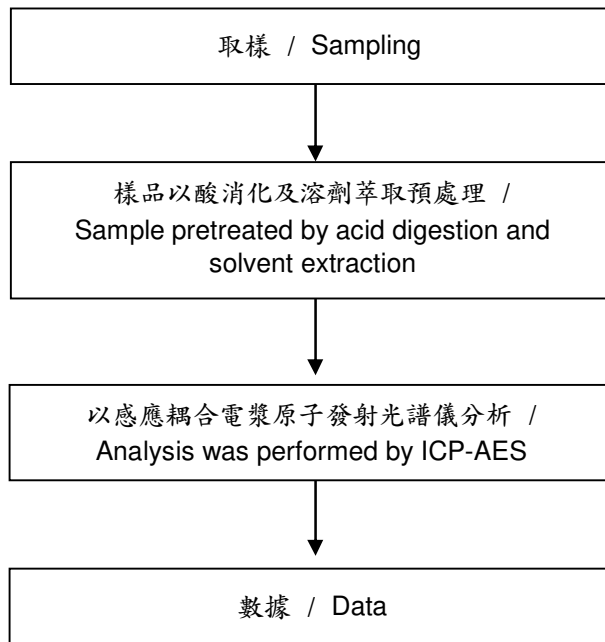

## 測試報告

## Test Report

號碼(No.) : CE/2015/20347

日期(Date) : 2015/02/16

頁數(Page): 54 of 65



南亞塑膠工業股份有限公司(台灣) / NAN YA PLASTICS CORPORATION (TAIWAN)

(南亞電子材料(昆山)有限公司 / NAN YA ELECTRONIC MATERIALS (KUNSHAN) CORP., LTD)

(南亞電子材料(惠州)有限公司 / NAN YA ELECTRONIC MATERIALS (HUIZHOU) CORP., LTD)

台灣台北市敦化北路201號 / 201 TUNG HWA NORTH ROAD, TAIPEI, TAIWAN

(江蘇省昆山昆山市長江南路201號 / 201 CHANG JIANG ROAD(S) KUNSHAN ECONOMIC & TECHNICAL DEVELOPMENT ZONE, JIANG SU)

(廣東省惠州市博羅縣石灣鎮永石大道 / YONGSHI BOULEVARD SHIWAN TOWN BOLUO COUNTY HUIZHOU CITY GUANG DONG)

### 苯並三唑類化合物分析流程圖 / Benzotriazole analytical flow chart

- 測試人員：翁賜彬 / Name of the person who made measurement: Roman Wong
- 測試負責人：張啓興 / Name of the person in charge of measurement: Troy Chang

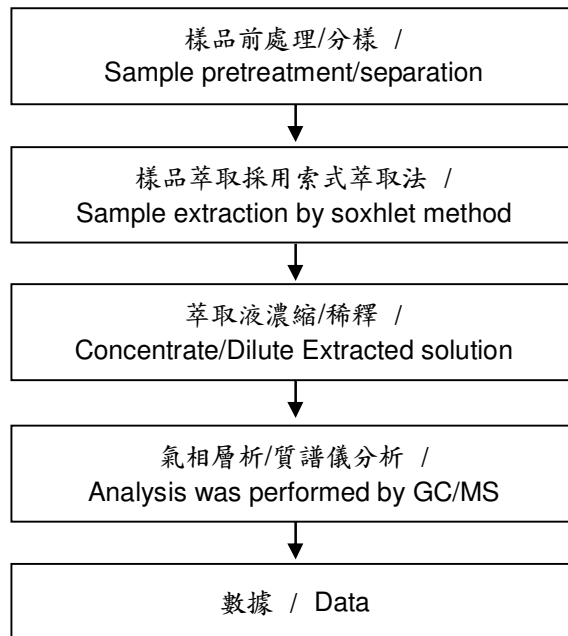

## 測試報告

## Test Report

號碼(No.) : CE/2015/20347

日期(Date) : 2015/02/16

頁數(Page): 55 of 65



南亞塑膠工業股份有限公司(台灣) / NAN YA PLASTICS CORPORATION (TAIWAN)

(南亞電子材料(昆山)有限公司 / NAN YA ELECTRONIC MATERIALS (KUNSHAN) CORP., LTD)

(南亞電子材料(惠州)有限公司 / NAN YA ELECTRONIC MATERIALS (HUIZHOU) CORP., LTD)

台灣台北市敦化北路201號 / 201 TUNG HWA NORTH ROAD, TAIPEI, TAIWAN

(江蘇省昆山昆山市長江南路201號 / 201 CHANG JIANG ROAD(S) KUNSHAN ECONOMIC & TECHNICAL DEVELOPMENT ZONE, JIANG SU)

(廣東省惠州市博羅縣石灣鎮永石大道 / YONGSHI BOULEVARD SHIWAN TOWN BOLUO COUNTY HUIZHOU CITY GUANG DONG)

### 全氟辛酸/全氟辛烷磺酸分析流程圖 / PFOA/PFOS analytical flow chart

- 測試人員：翁賜彬 / Name of the person who made measurement: Roman Wong
- 測試負責人：張啓興 / Name of the person in charge of measurement: Troy Chang

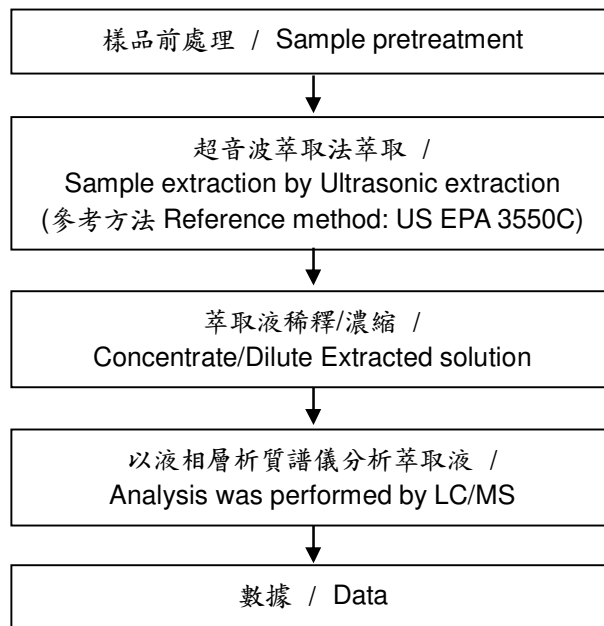

## 測試報告

## Test Report

號碼(No.) : CE/2015/20347

日期(Date) : 2015/02/16

頁數(Page): 56 of 65



南亞塑膠工業股份有限公司(台灣) / NAN YA PLASTICS CORPORATION (TAIWAN)

(南亞電子材料(昆山)有限公司 / NAN YA ELECTRONIC MATERIALS (KUNSHAN) CORP., LTD)

(南亞電子材料(惠州)有限公司 / NAN YA ELECTRONIC MATERIALS (HUIZHOU) CORP., LTD)

台灣台北市敦化北路201號 / 201 TUNG HWA NORTH ROAD, TAIPEI, TAIWAN

(江蘇省昆山昆山市長江南路201號 / 201 CHANG JIANG ROAD(S) KUNSHAN ECONOMIC & TECHNICAL DEVELOPMENT ZONE, JIANG SU)

(廣東省惠州市博羅縣石灣鎮永石大道 / YONGSHI BOULEVARD SHIWAN TOWN BOLUO COUNTY HUIZHOU CITY GUANG DONG)

### 石綿鑑定分析流程圖 / Analysis flow chart for determination of Asbestos

- 測試人員：高鍵忠 / Name of the person who made measurement: Victor Kao
- 測試負責人：魏明芬 / Name of the person in charge of measurement: Wendy Wei

#### 【參考方法(Reference method): EPA 600/R-93/116】

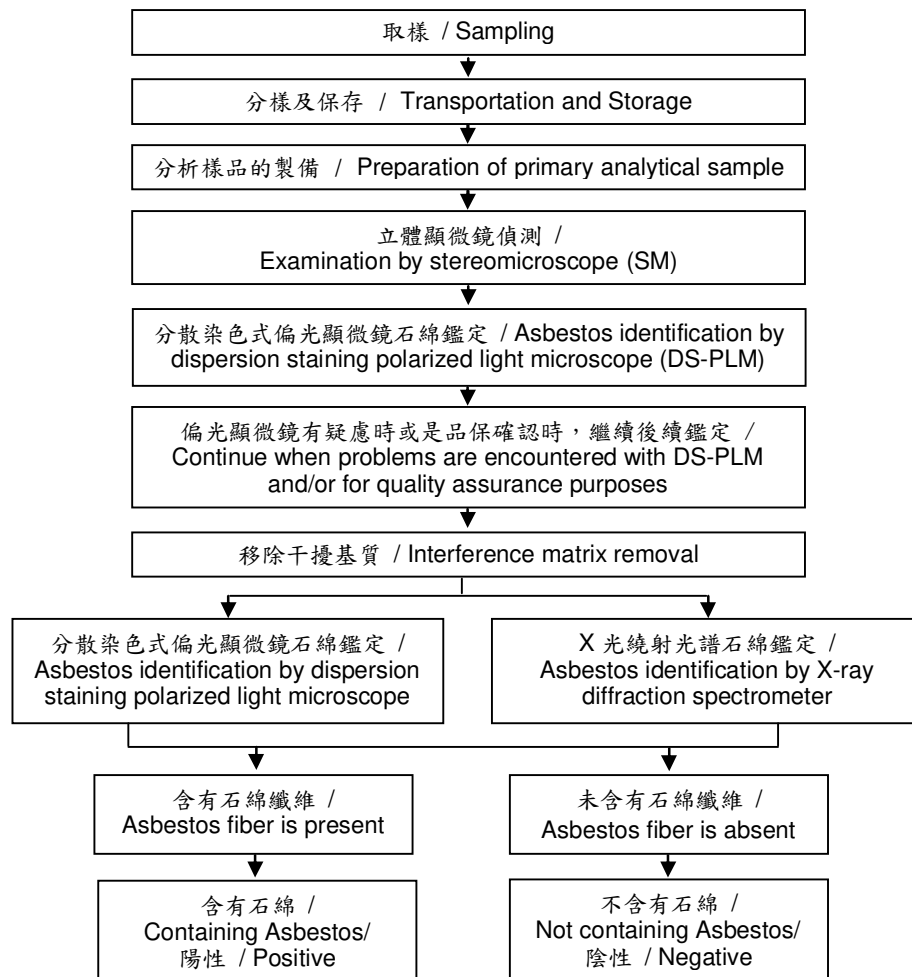

This document is issued by the Company subject to its General Conditions of Service printed overleaf, available on request or accessible at <http://www.sgs.com/en/Terms-and-Conditions.aspx> and, for electronic format documents, subject to Terms and Conditions for Electronic Documents at <http://www.sgs.com/en/Terms-and-Conditions/Termse-Document.aspx>. Attention is drawn to the limitation of liability, indemnification and jurisdiction issues defined therein. Any holder of this document is advised that information contained hereon reflects the Company's findings at the time of its intervention only and within the limits of client's instruction, if any. The Company's sole responsibility is to its Client and this document does not exonerate parties to a transaction from exercising all their rights and obligations under the transaction documents. This document cannot be reproduced, except in full, without prior written approval of the Company. Any unauthorized alteration, forgery or falsification of the content or appearance of this document is unlawful and offenders may be prosecuted to the fullest extent of the law. Unless otherwise stated the results shown in this test report refer only to the sample(s) tested.

## 測試報告

## Test Report

號碼(No.) : CE/2015/20347

日期(Date) : 2015/02/16

頁數(Page): 57 of 65



南亞塑膠工業股份有限公司(台灣) / NAN YA PLASTICS CORPORATION (TAIWAN)

(南亞電子材料(昆山)有限公司 / NAN YA ELECTRONIC MATERIALS (KUNSHAN) CORP., LTD)

(南亞電子材料(惠州)有限公司 / NAN YA ELECTRONIC MATERIALS (HUIZHOU) CORP., LTD)

台灣台北市敦化北路201號 / 201 TUNG HWA NORTH ROAD, TAIPEI, TAIWAN

(江蘇省昆山昆山市長江南路201號 / 201 CHANG JIANG ROAD(S) KUNSHAN ECONOMIC & TECHNICAL DEVELOPMENT ZONE, JIANG SU)

(廣東省惠州市博羅縣石灣鎮永石大道 / YONGSHI BOULEVARD SHIWAN TOWN BOLUO COUNTY HUIZHOU CITY GUANG DONG)

### 有機錫分析流程圖 / Analytical flow chart of Organic-Tin content

- 測試人員：林建宇 / Name of the person who made measurement: Roy Lin
- 測試負責人：張啓興 / Name of the person in charge of measurement: Troy Chang

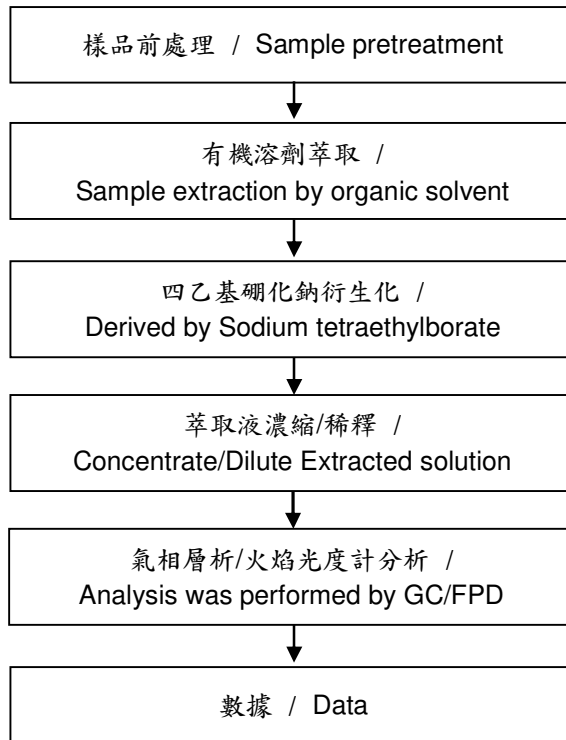



## 測試報告

## Test Report

號碼(No.) : CE/2015/20347

日期(Date) : 2015/02/16

頁數(Page): 58 of 65



南亞塑膠工業股份有限公司(台灣) / NAN YA PLASTICS CORPORATION (TAIWAN)

(南亞電子材料(昆山)有限公司) / NAN YA ELECTRONIC MATERIALS (KUNSHAN) CORP., LTD)

(南亞電子材料(惠州)有限公司) / NAN YA ELECTRONIC MATERIALS (HUIZHOU) CORP., LTD)

台灣台北市敦化北路201號 / 201 TUNG HWA NORTH ROAD, TAIPEI, TAIWAN

(江蘇省昆山昆山市長江南路201號 / 201 CHANG JIANG ROAD(S) KUNSHAN ECONOMIC & TECHNICAL DEVELOPMENT ZONE, JIANG SU)

(廣東省惠州市博羅縣石灣鎮永石大道 / YONGSHI BOULEVARD SHIWAN TOWN BOLUO COUNTY HUIZHOU CITY GUANG DONG)

### 聚氯乙稀物質判定分析流程圖 /

### Analysis flow chart for determination of PVC in material

- 測試人員：林建宇 / Name of the person who made measurement: Roy Lin
- 測試負責人：張啓興 / Name of the person in charge of measurement: Troy Chang

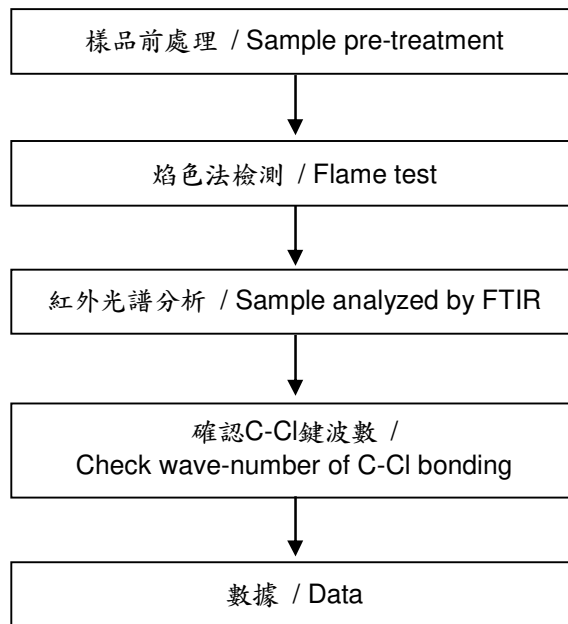

## 測試報告

## Test Report

號碼(No.) : CE/2015/20347

日期(Date) : 2015/02/16

頁數(Page): 59 of 65



南亞塑膠工業股份有限公司(台灣) / NAN YA PLASTICS CORPORATION (TAIWAN)

(南亞電子材料(昆山)有限公司) / NAN YA ELECTRONIC MATERIALS (KUNSHAN) CORP., LTD)

(南亞電子材料(惠州)有限公司) / NAN YA ELECTRONIC MATERIALS (HUIZHOU) CORP., LTD)

台灣台北市敦化北路201號 / 201 TUNG HWA NORTH ROAD, TAIPEI, TAIWAN

(江蘇省昆山昆山市長江南路201號 / 201 CHANG JIANG ROAD(S) KUNSHAN ECONOMIC & TECHNICAL DEVELOPMENT ZONE, JIANG SU)

(廣東省惠州市博羅縣石灣鎮永石大道 / YONGSHI BOULEVARD SHIWAN TOWN BOLUO COUNTY HUIZHOU CITY GUANG DONG)

### 甲醛分析流程圖 / Formaldehyde analytical flow chart

- 測試人員：涂雅苓 / Name of the person who made measurement: Yaling Tu
- 測試負責人：張啓興 / Name of the person in charge of measurement: Troy Chang

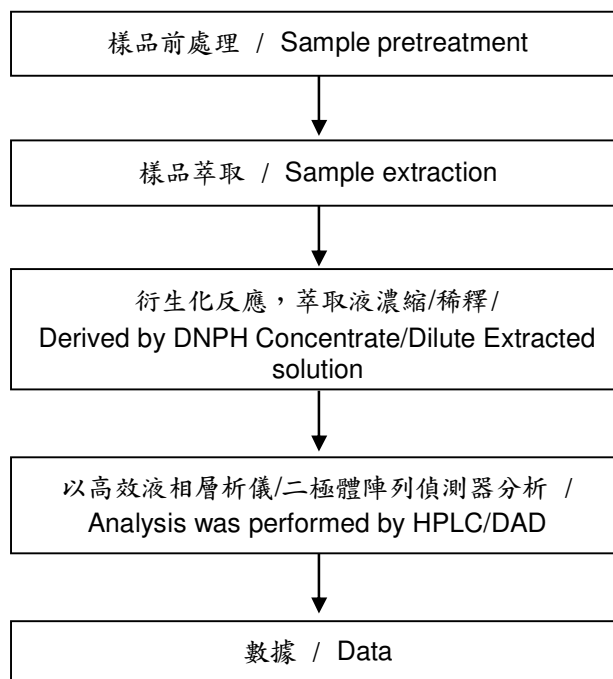

## 測試報告

## Test Report

號碼(No.) : CE/2015/20347

日期(Date) : 2015/02/16

頁數(Page): 60 of 65



南亞塑膠工業股份有限公司(台灣) / NAN YA PLASTICS CORPORATION (TAIWAN)

(南亞電子材料(昆山)有限公司 / NAN YA ELECTRONIC MATERIALS (KUNSHAN) CORP., LTD)

(南亞電子材料(惠州)有限公司 / NAN YA ELECTRONIC MATERIALS (HUIZHOU) CORP., LTD)

台灣台北市敦化北路201號 / 201 TUNG HWA NORTH ROAD, TAIPEI, TAIWAN

(江蘇省昆山昆山市長江南路201號 / 201 CHANG JIANG ROAD(S) KUNSHAN ECONOMIC & TECHNICAL DEVELOPMENT ZONE, JIANG SU)

(廣東省惠州市博羅縣石灣鎮永石大道 / YONGSHI BOULEVARD SHIWAN TOWN BOLUO COUNTY HUIZHOU CITY GUANG DONG)

### 氯化石蠟分析流程圖 / Chlorinated Paraffins analytical flow chart

- 測試人員：曾勃鈞 / Name of the person who made measurement: Barry Tseng
- 測試負責人：張啓興 / Name of the person in charge of measurement: Troy Chang

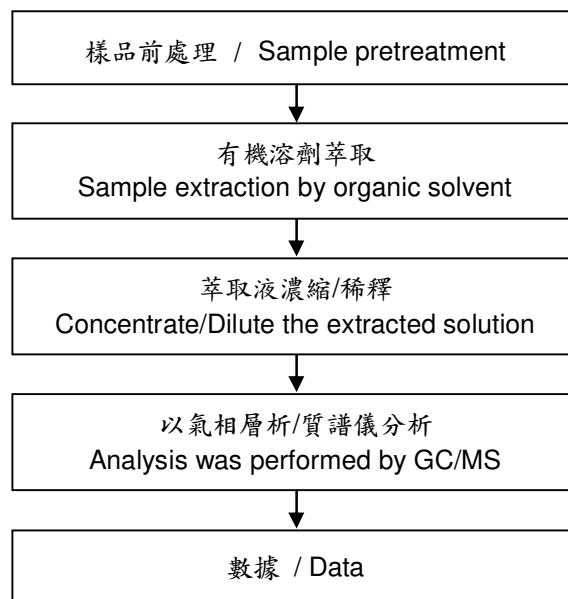

## 測試報告

## Test Report

號碼(No.) : CE/2015/20347

日期(Date) : 2015/02/16

頁數(Page): 61 of 65



南亞塑膠工業股份有限公司(台灣) / NAN YA PLASTICS CORPORATION (TAIWAN)

(南亞電子材料(昆山)有限公司 / NAN YA ELECTRONIC MATERIALS (KUNSHAN) CORP., LTD)

(南亞電子材料(惠州)有限公司 / NAN YA ELECTRONIC MATERIALS (HUIZHOU) CORP., LTD)

台灣台北市敦化北路201號 / 201 TUNG HWA NORTH ROAD, TAIPEI, TAIWAN

(江蘇省昆山昆山市長江南路201號 / 201 CHANG JIANG ROAD(S) KUNSHAN ECONOMIC & TECHNICAL DEVELOPMENT ZONE, JIANG SU)

(廣東省惠州市博羅縣石灣鎮永石大道 / YONGSHI BOULEVARD SHIWAN TOWN BOLUO COUNTY HUIZHOU CITY GUANG DONG)

### 多氯三聯苯分析流程圖 / PCTs analytical flow chart

- 測試人員：曾勃鈞 / Name of the person who made measurement: Barry Tseng
- 測試負責人：張啓興 / Name of the person in charge of measurement: Troy Chang

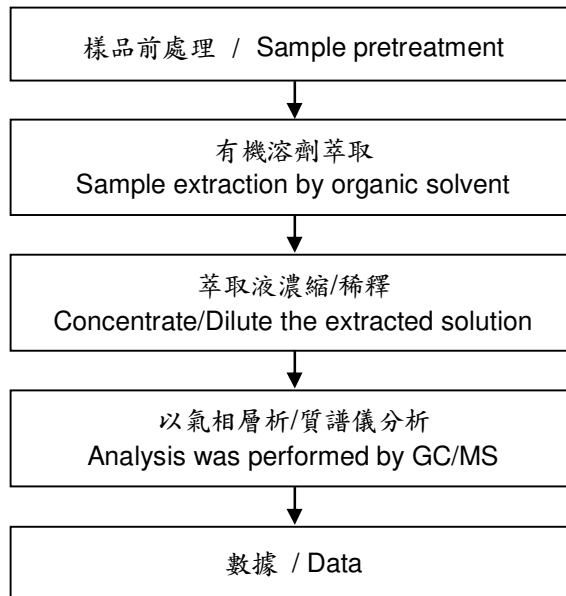

## 測試報告

## Test Report

號碼(No.) : CE/2015/20347

日期(Date) : 2015/02/16

頁數(Page): 62 of 65



南亞塑膠工業股份有限公司(台灣) / NAN YA PLASTICS CORPORATION (TAIWAN)

(南亞電子材料(昆山)有限公司 / NAN YA ELECTRONIC MATERIALS (KUNSHAN) CORP., LTD)

(南亞電子材料(惠州)有限公司 / NAN YA ELECTRONIC MATERIALS (HUIZHOU) CORP., LTD)

台灣台北市敦化北路201號 / 201 TUNG HWA NORTH ROAD, TAIPEI, TAIWAN

(江蘇省昆山昆山市長江南路201號 / 201 CHANG JIANG ROAD(S) KUNSHAN ECONOMIC & TECHNICAL DEVELOPMENT ZONE, JIANG SU)

(廣東省惠州市博羅縣石灣鎮永石大道 / YONGSHI BOULEVARD SHIWAN TOWN BOLUO COUNTY HUIZHOU CITY GUANG DONG)

### 多氯奈分析流程圖 / PCNs analytical flow chart

- 測試人員：曾勃鈞 / Name of the person who made measurement: Barry Tseng
- 測試負責人：張啓興 / Name of the person in charge of measurement: Troy Chang

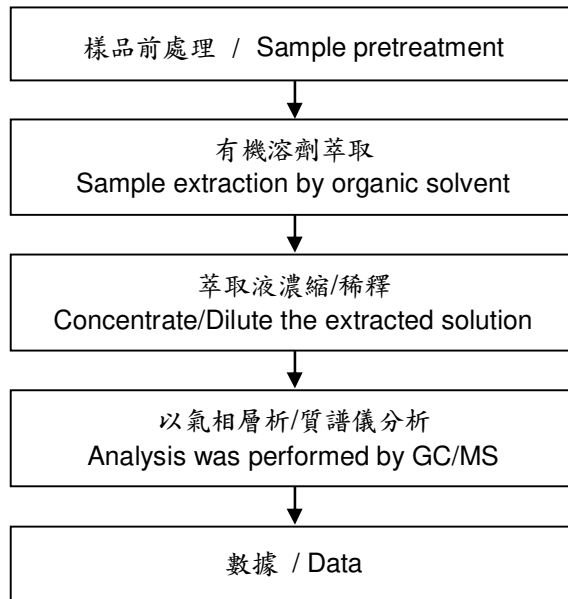

## 測試報告

## Test Report

號碼(No.) : CE/2015/20347

日期(Date) : 2015/02/16

頁數(Page): 63 of 65



南亞塑膠工業股份有限公司(台灣) / NAN YA PLASTICS CORPORATION (TAIWAN)

(南亞電子材料(昆山)有限公司 / NAN YA ELECTRONIC MATERIALS (KUNSHAN) CORP., LTD)

(南亞電子材料(惠州)有限公司 / NAN YA ELECTRONIC MATERIALS (HUIZHOU) CORP., LTD)

台灣台北市敦化北路201號 / 201 TUNG HWA NORTH ROAD, TAIPEI, TAIWAN

(江蘇省昆山昆山市長江南路201號 / 201 CHANG JIANG ROAD(S) KUNSHAN ECONOMIC & TECHNICAL DEVELOPMENT ZONE, JIANG SU)

(廣東省惠州市博羅縣石灣鎮永石大道 / YONGSHI BOULEVARD SHIWAN TOWN BOLUO COUNTY HUIZHOU CITY GUANG DONG)

### 多氣聯苯分析流程圖 / PCBs analytical flow chart

- 測試人員：曾勃鈞 / Name of the person who made measurement: Barry Tseng
- 測試負責人：張啓興 / Name of the person in charge of measurement: Troy Chang

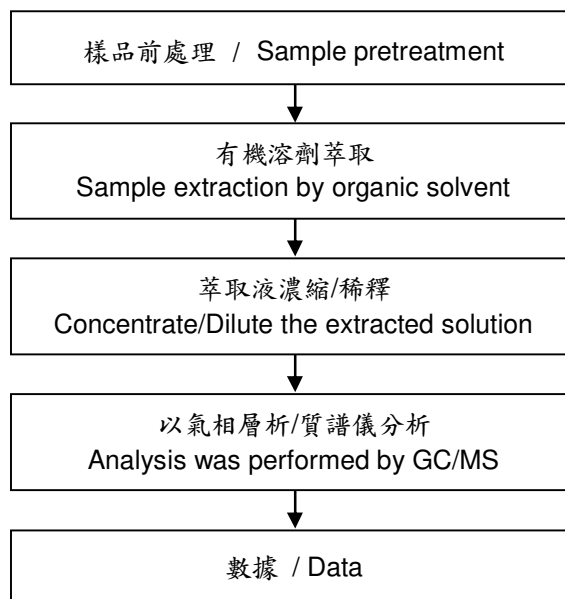



## 測試報告

## Test Report

號碼(No.) : CE/2015/20347

日期(Date) : 2015/02/16

頁數(Page): 64 of 65



南亞塑膠工業股份有限公司(台灣) / NAN YA PLASTICS CORPORATION (TAIWAN)

(南亞電子材料(昆山)有限公司 / NAN YA ELECTRONIC MATERIALS (KUNSHAN) CORP., LTD)

(南亞電子材料(惠州)有限公司 / NAN YA ELECTRONIC MATERIALS (HUIZHOU) CORP., LTD)

台灣台北市敦化北路201號 / 201 TUNG HWA NORTH ROAD, TAIPEI, TAIWAN

(江蘇省昆山昆山市長江南路201號 / 201 CHANG JIANG ROAD(S) KUNSHAN ECONOMIC & TECHNICAL DEVELOPMENT ZONE, JIANG SU)

(廣東省惠州市博羅縣石灣鎮永石大道 / YONGSHI BOULEVARD SHIWAN TOWN BOLUO COUNTY HUIZHOU CITY GUANG DONG)

### 多溴聯苯/多溴聯苯醚分析流程圖 / PBB/PBDE analytical FLOW CHART

- 測試人員：翁賜彬 / Name of the person who made measurement: Roman Wong
  - 測試負責人：張啓興 / Name of the person in charge of measurement: Troy Chang
- 初次測試程序 / First testing process —————▶
- 選擇性篩檢程序 / Optional screen process .....▶
- 確認程序 / Confirmation process - - - ▶

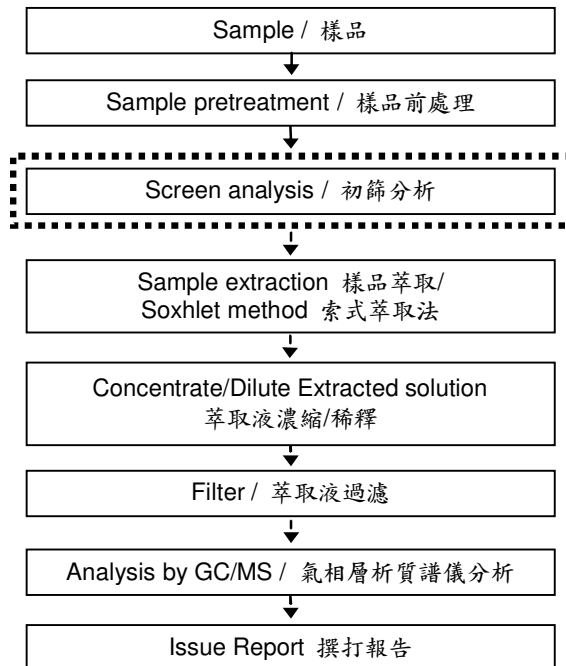

This document is issued by the Company subject to its General Conditions of Service printed overleaf, available on request or accessible at <http://www.sgs.com/en/Terms-and-Conditions.aspx> and, for electronic format documents, subject to Terms and Conditions for Electronic Documents at <http://www.sgs.com/en/Terms-and-Conditions/Termse-Document.aspx>. Attention is drawn to the limitation of liability, indemnification and jurisdiction issues defined therein. Any holder of this document is advised that information contained hereon reflects the Company's findings at the time of its intervention only and within the limits of client's instruction, if any. The Company's sole responsibility is to its Client and this document does not exonerate parties to a transaction from exercising all their rights and obligations under the transaction documents. This document cannot be reproduced, except in full, without prior written approval of the Company. Any unauthorized alteration, forgery or falsification of the content or appearance of this document is unlawful and offenders may be prosecuted to the fullest extent of the law. Unless otherwise stated the results shown in this test report refer only to the sample(s) tested.

## 測試報告

## Test Report

號碼(No.) : CE/2015/20347

日期(Date) : 2015/02/16

頁數(Page): 65 of 65



南亞塑膠工業股份有限公司(台灣) / NAN YA PLASTICS CORPORATION (TAIWAN)

(南亞電子材料(昆山)有限公司 / NAN YA ELECTRONIC MATERIALS (KUNSHAN) CORP., LTD)

(南亞電子材料(惠州)有限公司 / NAN YA ELECTRONIC MATERIALS (HUIZHOU) CORP., LTD)

台灣台北市敦化北路201號 / 201 TUNG HWA NORTH ROAD, TAIPEI, TAIWAN

(江蘇省昆山昆山市長江南路201號 / 201 CHANG JIANG ROAD(S) KUNSHAN ECONOMIC & TECHNICAL DEVELOPMENT ZONE, JIANG SU)

(廣東省惠州市博羅縣石灣鎮永石大道 / YONGSHI BOULEVARD SHIWAN TOWN BOLUO COUNTY HUIZHOU CITY GUANG DONG)

\* 照片中如有箭頭標示，則表示為實際檢測之樣品/部位。\*

(The tested sample / part is marked by an arrow if it's shown on the photo.)

### CE/2015/20347

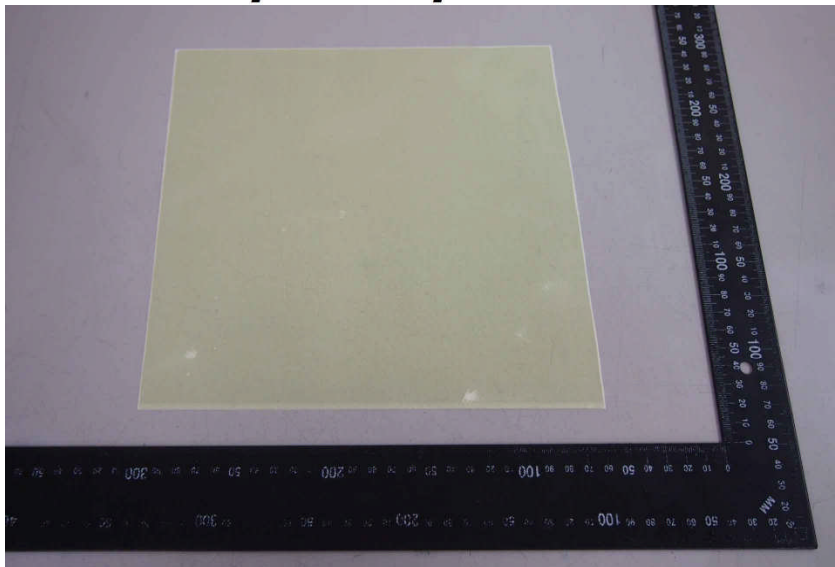

\*\* 報告結尾 (End of Report) \*\*

## 測試報告

## Test Report

號碼(No.) : CE/2015/20344

日期(Date) : 2015/02/16

頁數(Page): 1 of 65



南亞塑膠工業股份有限公司(台灣) / NAN YA PLASTICS CORPORATION (TAIWAN)

(南亞電子材料(昆山)有限公司 / NAN YA ELECTRONIC MATERIALS (KUNSHAN) CORP., LTD)

(南亞電子材料(惠州)有限公司 / NAN YA ELECTRONIC MATERIALS (HUIZHOU) CORP., LTD)

台灣台北市敦化北路201號 / 201 TUNG HWA NORTH ROAD, TAIPEI, TAIWAN

(江蘇省昆山市市長江南路201號 / 201 CHANG JIANG ROAD(S) KUNSHAN ECONOMIC & TECHNICAL DEVELOPMENT ZONE, JIANG SU)

(廣東省惠州市博羅縣石灣鎮永石大道 / YONGSHI BOULEVARD SHIWAN TOWN BOLUO COUNTY HUIZHOU CITY GUANG DONG)

以下測試樣品係由申請廠商所提供及確認 (The following sample(s) was/were submitted and identified by/on behalf of the applicant as):

送樣廠商(Sample Submitted By) : 南亞塑膠工業股份有限公司 (NAN YA PLASTICS CORPORATION)  
樣品名稱(Sample Description) : LAMINATE (UL E98983)  
樣品型號(Style/Item No.) : UV BLOCK FR-4-86/NP-140TL  
買主/訂單號碼(Buyer/Order No.) : 5106236  
收件日期(Sample Receiving Date) : 2015/02/02  
測試期間(Testing Period) : 2015/02/02 TO 2015/02/16

### 測試需求(Test Requested) :

- (1) 依據客戶要求, 參考RoHS 2011/65/EU Annex II 指令測試鎘、鉛、汞、六價鉻、多溴聯苯、多溴聯苯醚。(As specified by client, with reference to RoHS Directive 2011/65/EU Annex II to determine Cadmium, Lead, Mercury, Cr(VI), PBBs, PBDEs contents in the submitted sample.)
- (2) 依據客戶要求, 參考 WTO/TBT 通報 G/TBT/N/EU/256, 檢測 DBP, BBP, DEHP, DIBP. (As specified by client, with reference to G/TBT/N/EU/256 of WTO/TBT to test DBP, BBP, DEHP, DIBP.)
- (3) 依據客戶要求, 檢測 PAHs 及其他測項. / As specified by client, to test PAHs and other item(s).

測試結果(Test Results) : 請見下一頁 (Please refer to next pages).

結論(Conclusion) : 請見下一頁 (Please refer to next pages).

  
Troy Chang / Manager - Tech  
Signed for and on Behalf of  
SGS TAIWAN LTD.  
Chemical Laboratory - Taipei

## 測試報告

## Test Report

號碼(No.) : CE/2015/20344

日期(Date) : 2015/02/16

頁數(Page): 2 of 65



南亞塑膠工業股份有限公司(台灣) / NAN YA PLASTICS CORPORATION (TAIWAN)

(南亞電子材料(昆山)有限公司 / NAN YA ELECTRONIC MATERIALS (KUNSHAN) CORP., LTD)

(南亞電子材料(惠州)有限公司 / NAN YA ELECTRONIC MATERIALS (HUIZHOU) CORP., LTD)

台灣台北市敦化北路201號 / 201 TUNG HWA NORTH ROAD, TAIPEI, TAIWAN

(江蘇省昆山昆山市長江南路201號 / 201 CHANG JIANG ROAD(S) KUNSHAN ECONOMIC & TECHNICAL DEVELOPMENT ZONE, JIANG SU)

(廣東省惠州市博羅縣石灣鎮永石大道 / YONGSHI BOULEVARD SHIWAN TOWN BOLUO COUNTY HUIZHOU CITY GUANG DONG)

- 結論(Conclusion) :**
- (1) 根據客戶所提供的樣品，其鎘、鉛、汞、六價鉻、多溴聯苯、多溴聯苯醚的測試結果符合 RoHS 指令 2011/65/EU Annex II 之要求 (Based on the performed tests on submitted samples, the test result(s) of Cadmium, Lead, Mercury, Cr(VI), PBBs, PBDEs comply with the limits as set by RoHS Directive 2011/65/EU Annex II.)
  - (2) 根據客戶所提供的樣品，其 DBP, BBP, DEHP, DIBP 之測試結果符合 WTO/TBT 通報 G/TBT/N/EU/256 之限值要求 (Based on the performed tests on submitted samples, the test results of DBP, BBP, DEHP, DIBP comply with the limits as set by G/TBT/N/EU/256 of WTO/TBT.)
  - (3) 根據客戶所提供的樣品，其 PAHs 的測試結果符合德國 ZLS 的 ZEK 01.4-08 及其相關修訂文件中的第 1 類 PAHs 要求 (Base upon the performed tests by submitted samples, the test results of PAHs comply with the PAHs requirement according to (Category 1) of ZEK 01.4-08 of German ZLS and its amendments.)

# 測試報告

# Test Report

號碼(No.) : CE/2015/20344

日期(Date) : 2015/02/16

頁數(Page): 3 of 65



南亞塑膠工業股份有限公司(台灣) / NAN YA PLASTICS CORPORATION (TAIWAN)

(南亞電子材料(昆山)有限公司 / NAN YA ELECTRONIC MATERIALS (KUNSHAN) CORP., LTD)

(南亞電子材料(惠州)有限公司 / NAN YA ELECTRONIC MATERIALS (HUIZHOU) CORP., LTD)

台灣台北市敦化北路201號 / 201 TUNG HWA NORTH ROAD, TAIPEI, TAIWAN

(江蘇省昆山昆山市長江南路201號 / 201 CHANG JIANG ROAD(S) KUNSHAN ECONOMIC & TECHNICAL DEVELOPMENT ZONE, JIANG SU)

(廣東省惠州市博羅縣石灣鎮永石大道 / YONGSHI BOULEVARD SHIWAN TOWN BOLUO COUNTY HUIZHOU CITY GUANG DONG)

## 測試結果(Test Results)

測試部位(PART NAME)No.1 : 銅色板子 (COPPER COLORED SHEET)

測試項目 (Test Items)	單位 (Unit)	測試方法 (Method)	方法偵測 極限值 (MDL)	結果 (Result)	限值 (Limit)
				No.1	
鎘 / Cadmium (Cd)	mg/kg	參考IEC 62321-5: 2013方法, 以感應 耦合電漿原子發射光譜儀檢測. / With reference to IEC 62321-5: 2013 and performed by ICP-AES.	2	n.d.	100
鉛 / Lead (Pb)	mg/kg	參考IEC 62321-5: 2013方法, 以感應 耦合電漿原子發射光譜儀檢測. / With reference to IEC 62321-5: 2013 and performed by ICP-AES.	2	9	1000
汞 / Mercury (Hg)	mg/kg	參考IEC 62321-4: 2013方法, 以感應 耦合電漿原子發射光譜儀檢測. / With reference to IEC 62321-4: 2013 and performed by ICP-AES.	2	n.d.	1000
六價鉻 / Hexavalent Chromium Cr(VI)	mg/kg	參考IEC 62321: 2008方法, 以UV-VIS 檢測. / With reference to IEC 62321: 2008 and performed by UV- VIS.	2	n.d.	1000
鈹 / Beryllium (Be)	mg/kg	參考US EPA 3052方法, 以感應耦合電 漿原子發射光譜儀檢測. / With reference to US EPA Method 3052. Analysis was performed by ICP-AES.	2	n.d.	-
氧化鈹 / Beryllium oxide (BeO)***	mg/kg	參考US EPA 3052方法, 以感應耦合電 漿原子發射光譜儀檢測. / With reference to US EPA Method 3052. Analysis was performed by ICP- AES.***	-	n.d.	-

This document is issued by the Company subject to its General Conditions of Service printed overleaf, available on request or accessible at <http://www.sgs.com/en/Terms-and-Conditions.aspx> and, for electronic format documents, subject to Terms and Conditions for Electronic Documents at <http://www.sgs.com/en/Terms-and-Conditions/Termse-Document.aspx>. Attention is drawn to the limitation of liability, indemnification and jurisdiction issues defined therein. Any holder of this document is advised that information contained hereon reflects the Company's findings at the time of its intervention only and within the limits of client's instruction, if any. The Company's sole responsibility is to its Client and this document does not exonerate parties to a transaction from exercising all their rights and obligations under the transaction documents. This document cannot be reproduced, except in full, without prior written approval of the Company. Any unauthorized alteration, forgery or falsification of the content or appearance of this document is unlawful and offenders may be prosecuted to the fullest extent of the law. Unless otherwise stated the results shown in this test report refer only to the sample(s) tested.

# 測試報告

# Test Report

號碼(No.) : CE/2015/20344

日期(Date) : 2015/02/16

頁數(Page): 4 of 65



南亞塑膠工業股份有限公司(台灣) / NAN YA PLASTICS CORPORATION (TAIWAN)  
 (南亞電子材料(昆山)有限公司 / NAN YA ELECTRONIC MATERIALS (KUNSHAN) CORP., LTD)  
 (南亞電子材料(惠州)有限公司 / NAN YA ELECTRONIC MATERIALS (HUIZHOU) CORP., LTD)  
 台灣台北市敦化北路201號 / 201 TUNG HWA NORTH ROAD, TAIPEI, TAIWAN  
 (江蘇省昆山市長江南路201號 / 201 CHANG JIANG ROAD(S) KUNSHAN ECONOMIC & TECHNICAL DEVELOPMENT ZONE, JIANG SU)  
 (廣東省惠州市博羅縣石灣鎮永石大道 / YONGSHI BOULEVARD SHIWAN TOWN BOLUO COUNTY HUIZHOU CITY GUANG DONG)

測試項目 (Test Items)	單位 (Unit)	測試方法 (Method)	方法偵測 極限值 (MDL)	結果 (Result)	限值 (Limit)
				No. 1	
砷 / Arsenic (As) (※2)	mg/kg	參考SGS內部方法RSTS-EE-SVHC-007, 以感應耦合電漿原子發射光譜儀檢測。 / SGS In-House method-RSTS-EE-SVHC-007. Analyzed by ICP-AES.	50	n.d.	-
五氧化二砷 / Diarsenic pentaoxide*** (CAS No.: 1303-28-2)	mg/kg	參考SGS內部方法RSTS-EE-SVHC-007, 以感應耦合電漿原子發射光譜儀檢測。 / SGS In-House method-RSTS-EE-SVHC-007. Analyzed by ICP-AES.***	-	n.d.	-
三氧化二砷 / Diarsenic trioxide*** (CAS No.: 1327-53-3)	mg/kg	參考SGS內部方法RSTS-EE-SVHC-007, 以感應耦合電漿原子發射光譜儀檢測。 / SGS In-House method-RSTS-EE-SVHC-007. Analyzed by ICP-AES.***	-	n.d.	-
銻 / Antimony (Sb)	mg/kg	參考US EPA 3052方法, 以感應耦合電漿原子發射光譜儀檢測。 / With reference to US EPA Method 3052. Analysis was performed by ICP-AES.	2	n.d.	-
硼 / Boron (B) (※2)	mg/kg	參考SGS內部方法RSTS-EE-SVHC-007, 以感應耦合電漿原子發射光譜儀檢測。 / SGS In-House method-RSTS-EE-SVHC-007. Analyzed by ICP-AES.	50	n.d.	-
硼酸 / Boric acid*** (CAS No.: 10043-35-3; 11113-50-1)	mg/kg	參考SGS內部方法RSTS-EE-SVHC-007, 以感應耦合電漿原子發射光譜儀檢測。 / SGS In-House method-RSTS-EE-SVHC-007. Analyzed by ICP-AES.***	-	n.d.	-
無水四硼酸二鈉 / Disodium tetraborate, anhydrous*** (CAS No.: 1303-96-4, 1330-43-4, 12179-04-3)	mg/kg	參考SGS內部方法RSTS-EE-SVHC-007, 以感應耦合電漿原子發射光譜儀檢測。 / SGS In-House method-RSTS-EE-SVHC-007. Analyzed by ICP-AES.***	-	n.d.	-

This document is issued by the Company subject to its General Conditions of Service printed overleaf, available on request or accessible at <http://www.sgs.com/en/Terms-and-Conditions.aspx> and, for electronic format documents, subject to Terms and Conditions for Electronic Documents at <http://www.sgs.com/en/Terms-and-Conditions/Termse-Documents.aspx>. Attention is drawn to the limitation of liability, indemnification and jurisdiction issues defined therein. Any holder of this document is advised that information contained hereon reflects the Company's findings at the time of its intervention only and within the limits of client's instruction, if any. The Company's sole responsibility is to its Client and this document does not exonerate parties to a transaction from exercising all their rights and obligations under the transaction documents. This document cannot be reproduced, except in full, without prior written approval of the Company. Any unauthorized alteration, forgery or falsification of the content or appearance of this document is unlawful and offenders may be prosecuted to the fullest extent of the law. Unless otherwise stated the results shown in this test report refer only to the sample(s) tested.



# 測試報告

號碼(No.) : CE/2015/20344

日期(Date) : 2015/02/16

頁數(Page): 5 of 65

# Test Report



南亞塑膠工業股份有限公司(台灣) / NAN YA PLASTICS CORPORATION (TAIWAN)

(南亞電子材料(昆山)有限公司 / NAN YA ELECTRONIC MATERIALS (KUNSHAN) CORP., LTD)

(南亞電子材料(惠州)有限公司 / NAN YA ELECTRONIC MATERIALS (HUIZHOU) CORP., LTD)

台灣台北市敦化北路201號 / 201 TUNG HWA NORTH ROAD, TAIPEI, TAIWAN

(江蘇省昆山市長江南路201號 / 201 CHANG JIANG ROAD(S) KUNSHAN ECONOMIC & TECHNICAL DEVELOPMENT ZONE, JIANG SU)

(廣東省惠州市博羅縣石灣鎮永石大道 / YONGSHI BOULEVARD SHIWAN TOWN BOLUO COUNTY HUIZHOU CITY GUANG DONG)

測試項目 (Test Items)	單位 (Unit)	測試方法 (Method)	方法偵測 極限值 (MDL)	結果 (Result)	限值 (Limit)
				No.1	
水合硼酸鈉 / Tetraboron disodium heptaoxide, hydrate (CAS No.: 12267-73-1) (*2)	mg/kg	參考SGS內部方法RSTS-EE-SVHC-007, 以感應耦合電漿原子發射光譜儀檢測. / SGS In-House method-RSTS-EE-SVHC-007. Analyzed by ICP-AES.	-	n.d.	-
四溴雙酚-A / Tetrabromobisphenol A (TBBP-A) (CAS No.: 79-94-7)	mg/kg	參考Global SOP RSTS-E&E-121方法, 以液相層析/質譜儀分析. / With reference to Global SOP RSTS-E&E-121. Analysis was performed by LC/MS.	10	n.d.	-
雙酚 A / Bisphenol A (CAS No.: 80-05-7)	mg/kg	參考RSTS-HL-229-1方法, 以超高效能液相層析串聯質譜儀檢測. / With reference to RSTS-HL-229-1 method. Analysis was performed by UPLC-MSMS.	1	n.d.	-
全氟辛烷磺酸 / Perfluorooctane sulfonates (PFOS-Acid, Metal Salt, Amide)	mg/kg	參考US EPA 3550C: 2007方法, 以液相層析/質譜儀檢測. / With reference to US EPA 3550C: 2007. Analysis was performed by LC/MS.	10	n.d.	-
全氟辛酸 / PFOA (CAS No.: 335-67-1)	mg/kg	參考US EPA 3550C: 2007方法, 以液相層析/質譜儀檢測. / With reference to US EPA 3550C: 2007. Analysis was performed by LC/MS.	10	n.d.	-
2-(3', 5'-二叔丁基-2'-羥基苯基)苯並三氮唑 / 2-(3,5-di-tert-butyl-2-hydroxyphenyl)-2H-benzotriazole (CAS No.: 3846-71-7)	mg/kg	參考US EPA 3540C方法, 以氣相層析/質譜儀檢測之. / With reference to US EPA 3540C method. Analysis was performed by GC/MS.	5	n.d.	-
二氯化鈷 / Cobalt dichloride (CAS No.: 7646-79-9)	mg/kg	參考SGS內部方法RSTS-EE-SVHC-007, 以感應耦合電漿原子發射光譜儀檢測. / SGS In-House method-RSTS-EE-SVHC-007. Analyzed by ICP-AES.	50	n.d.	-

This document is issued by the Company subject to its General Conditions of Service printed overleaf, available on request or accessible at <http://www.sgs.com/en/Terms-and-Conditions.aspx> and, for electronic format documents, subject to Terms and Conditions for Electronic Documents at <http://www.sgs.com/en/Terms-and-Conditions/Termse-Documents.aspx>. Attention is drawn to the limitation of liability, indemnification and jurisdiction issues defined therein. Any holder of this document is advised that information contained hereon reflects the Company's findings at the time of its intervention only and within the limits of client's instruction, if any. The Company's sole responsibility is to its Client and this document does not exonerate parties to a transaction from exercising all their rights and obligations under the transaction documents. This document cannot be reproduced, except in full, without prior written approval of the Company. Any unauthorized alteration, forgery or falsification of the content or appearance of this document is unlawful and offenders may be prosecuted to the fullest extent of the law. Unless otherwise stated the results shown in this test report refer only to the sample(s) tested.

# 測試報告

# Test Report

號碼(No.) : CE/2015/20344

日期(Date) : 2015/02/16

頁數(Page): 6 of 65



南亞塑膠工業股份有限公司(台灣) / NAN YA PLASTICS CORPORATION (TAIWAN)  
 (南亞電子材料(昆山)有限公司 / NAN YA ELECTRONIC MATERIALS (KUNSHAN) CORP., LTD)  
 (南亞電子材料(惠州)有限公司 / NAN YA ELECTRONIC MATERIALS (HUIZHOU) CORP., LTD)  
 台灣台北市敦化北路201號 / 201 TUNG HWA NORTH ROAD, TAIPEI, TAIWAN  
 (江蘇省昆山市長江南路201號 / 201 CHANG JIANG ROAD(S) KUNSHAN ECONOMIC & TECHNICAL DEVELOPMENT ZONE, JIANG SU)  
 (廣東省惠州市博羅縣石灣鎮永石大道 / YONGSHI BOULEVARD SHIWAN TOWN BOLUO COUNTY HUIZHOU CITY GUANG DONG)

測試項目 (Test Items)	單位 (Unit)	測試方法 (Method)	方法偵測 極限值 (MDL)	結果 (Result)	限值 (Limit)
				No. 1	
多氯聯苯 / Polychlorinated Biphenyls (PCBs) (CAS No.: 1336-36-3)	mg/kg	參考US EPA 3540C方法, 以氣相層析/質譜儀檢測. / With reference to US EPA 3540C method. Analysis was performed by GC/MS.	0.5	n.d.	-
多氯萘 / Polychlorinated Naphthalene (PCNs)	mg/kg	參考US EPA 3540C方法, 以氣相層析/質譜儀檢測. / With reference to US EPA 3540C method. Analysis was performed by GC/MS.	5	n.d.	-
多氯三聯苯 / Polychlorinated Terphenyls (PCTs)	mg/kg	參考US EPA 3540C方法, 以氣相層析/質譜儀檢測. / With reference to US EPA 3540C method. Analysis was performed by GC/MS.	0.5	n.d.	-
短鏈氯化石蠟 / Alkanes, C10-13, chloro (Short Chain Chlorinated Paraffins) (CAS No.: 85535-84-8)	mg/kg	參考US EPA 3540C方法, 以氣相層析/質譜儀檢測. / With reference to US EPA 3540C method. Analysis was performed by GC/MS.	100	n.d.	-
甲醛 / Formaldehyde (CAS No.: 50-00-0)	mg/kg	參考ISO 17226-1(2008)方法, 以高效液相層析儀/二極體陣列偵測器檢測. / With reference to ISO 17226-1(2008). Analysis was performed by HPLC/DAD.	3	n.d.	-
聚氯乙稀 / PVC	**	以紅外光譜分析及焰色法檢測. / Analysis was performed by FTIR and FLAME Test.	-	Negative	-
六氟化硫 / Sulfur Hexafluoride (SF6) (CAS No.: 2551-62-4)	mg/kg	參考US EPA 5021方法, 以氣相層析/質譜儀檢測. / With reference to US EPA 5021 method. Analysis was performed by GC/MS.	1	n.d.	-

This document is issued by the Company subject to its General Conditions of Service printed overleaf, available on request or accessible at <http://www.sgs.com/en/Terms-and-Conditions.aspx> and, for electronic format documents, subject to Terms and Conditions for Electronic Documents at <http://www.sgs.com/en/Terms-and-Conditions/Termse-Documents.aspx>. Attention is drawn to the limitation of liability, indemnification and jurisdiction issues defined therein. Any holder of this document is advised that information contained hereon reflects the Company's findings at the time of its intervention only and within the limits of client's instruction, if any. The Company's sole responsibility is to its Client and this document does not exonerate parties to a transaction from exercising all their rights and obligations under the transaction documents. This document cannot be reproduced, except in full, without prior written approval of the Company. Any unauthorized alteration, forgery or falsification of the content or appearance of this document is unlawful and offenders may be prosecuted to the fullest extent of the law. Unless otherwise stated the results shown in this test report refer only to the sample(s) tested.

# 測試報告

# Test Report

號碼(No.) : CE/2015/20344

日期(Date) : 2015/02/16

頁數(Page): 7 of 65



南亞塑膠工業股份有限公司(台灣) / NAN YA PLASTICS CORPORATION (TAIWAN)  
 (南亞電子材料(昆山)有限公司 / NAN YA ELECTRONIC MATERIALS (KUNSHAN) CORP., LTD)  
 (南亞電子材料(惠州)有限公司 / NAN YA ELECTRONIC MATERIALS (HUIZHOU) CORP., LTD)  
 台灣台北市敦化北路201號 / 201 TUNG HWA NORTH ROAD, TAIPEI, TAIWAN  
 (江蘇省昆山市長江南路201號 / 201 CHANG JIANG ROAD(S) KUNSHAN ECONOMIC & TECHNICAL DEVELOPMENT ZONE, JIANG SU)  
 (廣東省惠州市博羅縣石灣鎮永石大道 / YONGSHI BOULEVARD SHIWAN TOWN BOLUO COUNTY HUIZHOU CITY GUANG DONG)

測試項目 (Test Items)	單位 (Unit)	測試方法 (Method)	方法偵測 極限值 (MDL)	結果 (Result)	限值 (Limit)
				No.1	
富馬酸二甲酯 / Dimethyl Fumarate (CAS No.: 624-49-7)	mg/kg	參考US EPA 3550C方法, 以氣相層析/ 質譜儀檢測. / With reference to US EPA 3550C method. Analysis was performed by GC/MS.	0.1	n.d.	-
磷酸三(2-氯乙基)酯 / Tris (2- chloroethyl) phosphate (TCEP) (CAS No.: 115-96-8)	mg/kg	參考US EPA 3550C方法, 以氣相層析/ 質譜儀檢測. / With reference to US EPA 3550C method. Analysis was performed by GC/MS.	5	n.d.	-
磷酸三(1-氯-2-丙基)酯 / Tris(1- chloro-2-propyl) phosphate (TCPP) (CAS No.: 13674-84-5)	mg/kg	參考US EPA 3550C方法, 以氣相層析/ 質譜儀檢測. / With reference to US EPA 3550C method. Analysis was performed by GC/MS.	5	n.d.	-
磷酸三(1,3-二氯異丙基)酯 / Tris(1,3- dichloro-2-propyl)phosphate (TDCPP) (CAS No.: 13674-87-8)	mg/kg	參考US EPA 3550C方法, 以氣相層析/ 質譜儀檢測. / With reference to US EPA 3550C method. Analysis was performed by GC/MS.	5	n.d.	-
磷酸三(二甲苯)酯 / Trixylyl phosphate (TXP) (CAS No.: 25155-23- 1)	mg/kg	參考US EPA 3550C方法, 以氣相層析/ 質譜儀檢測. / With reference to US EPA 3550C method. Analysis was performed by GC/MS.	25	n.d.	-
六溴環十二烷及所有主要被辨別出的異構 物 / Hexabromocyclododecane (HBCDD) and all major diastereoisomers identified ( $\alpha$ - HBCDD, $\beta$ - HBCDD, $\gamma$ - HBCDD) (CAS No.: 25637-99-4 and 3194-55-6 (134237-51-7, 134237-50-6, 134237-52-8))	mg/kg	參考IEC 62321: 2008方法, 以氣相層 析/質譜儀檢測. / With reference to IEC 62321: 2008 method. Analysis was performed by GC/MS.	5	n.d.	-

This document is issued by the Company subject to its General Conditions of Service printed overleaf, available on request or accessible at <http://www.sgs.com/en/Terms-and-Conditions.aspx> and, for electronic format documents, subject to Terms and Conditions for Electronic Documents at <http://www.sgs.com/en/Terms-and-Conditions/Termse-Documents.aspx>. Attention is drawn to the limitation of liability, indemnification and jurisdiction issues defined therein. Any holder of this document is advised that information contained hereon reflects the Company's findings at the time of its intervention only and within the limits of client's instruction, if any. The Company's sole responsibility is to its Client and this document does not exonerate parties to a transaction from exercising all their rights and obligations under the transaction documents. This document cannot be reproduced, except in full, without prior written approval of the Company. Any unauthorized alteration, forgery or falsification of the content or appearance of this document is unlawful and offenders may be prosecuted to the fullest extent of the law. Unless otherwise stated the results shown in this test report refer only to the sample(s) tested.

# 測試報告

# Test Report

號碼(No.) : CE/2015/20344

日期(Date) : 2015/02/16

頁數(Page): 8 of 65



南亞塑膠工業股份有限公司(台灣) / NAN YA PLASTICS CORPORATION (TAIWAN)  
 (南亞電子材料(昆山)有限公司 / NAN YA ELECTRONIC MATERIALS (KUNSHAN) CORP., LTD)  
 (南亞電子材料(惠州)有限公司 / NAN YA ELECTRONIC MATERIALS (HUIZHOU) CORP., LTD)  
 台灣台北市敦化北路201號 / 201 TUNG HWA NORTH ROAD, TAIPEI, TAIWAN  
 (江蘇省昆山市市長江南路201號 / 201 CHANG JIANG ROAD(S) KUNSHAN ECONOMIC & TECHNICAL DEVELOPMENT ZONE, JIANG SU)  
 (廣東省惠州市博羅縣石灣鎮永石大道 / YONGSHI BOULEVARD SHIWAN TOWN BOLUO COUNTY HUIZHOU CITY GUANG DONG)

測試項目 (Test Items)	單位 (Unit)	測試方法 (Method)	方法偵測 極限值 (MDL)	結果 (Result)	限值 (Limit)
				No.1	
對特辛基苯酚 / 辛基酚 / 4-(1,1,3,3-tetramethylbutyl) phenol, (4-tert-Octylphenol) (CAS No.: 140-66-9)	mg/kg	參考US EPA 3550C方法, 以液相層析/質譜儀檢測. / With reference to US EPA 3550C method. Analysis was performed by LC/MS.	10	n.d.	-
双(2-甲氧基乙基)醚 / Bis(2-methoxyethyl) ether (CAS No.: 111-96-6)	mg/kg	參考US EPA 3550C方法, 以氣相層析/質譜儀檢測. / With reference to US EPA 3550C method. Analysis was performed by GC/MS.	10	n.d.	-
N,N-二甲基乙醯胺 / N,N-dimethylacetamide (DMAC) (CAS No.: 127-19-5)	mg/kg	參考US EPA 3550C方法, 以氣相層析/質譜儀檢測. / With reference to US EPA 3550C method. Analysis was performed by GC/MS.	10	n.d.	-
鄰苯二甲酸二(2-乙基己基)酯 / DEHP (Di-(2-ethylhexyl) phthalate) (CAS No.: 117-81-7)	mg/kg	參考IEC 62321-8 (111/321/CD), 以氣相層析儀/質譜儀檢測之. / With reference to IEC 62321-8 (111/321/CD). Analysis was performed by GC/MS.	50	n.d.	1000
鄰苯二甲酸二丁酯 / DBP (Dibutyl phthalate) (CAS No.: 84-74-2)	mg/kg		50	n.d.	1000
鄰苯二甲酸丁苄甲酯 / BBP (Butyl Benzyl phthalate) (CAS No.: 85-68-7)	mg/kg		50	n.d.	1000
鄰苯二甲酸二異丁酯 / DIBP (Di-isobutyl phthalate) (CAS No.: 84-69-5)	mg/kg		50	n.d.	1000
鄰苯二甲酸二異壬酯 / DINP (Di-isononyl phthalate) (CAS No.: 28553-12-0; 68515-48-0)	mg/kg		50	n.d.	-
鄰苯二甲酸二異癸酯 / DIDP (Di-isodecyl phthalate) (CAS No.: 26761-40-0; 68515-49-1)	mg/kg		50	n.d.	-
鄰苯二甲酸二正辛酯 / DNOP (Di-n-octyl phthalate) (CAS No.: 117-84-0)	mg/kg		50	n.d.	-

This document is issued by the Company subject to its General Conditions of Service printed overleaf, available on request or accessible at <http://www.sgs.com/en/Terms-and-Conditions.aspx> and, for electronic format documents, subject to Terms and Conditions for Electronic Documents at <http://www.sgs.com/en/Terms-and-Conditions/Termse-Document.aspx>. Attention is drawn to the limitation of liability, indemnification and jurisdiction issues defined therein. Any holder of this document is advised that information contained hereon reflects the Company's findings at the time of its intervention only and within the limits of client's instruction, if any. The Company's sole responsibility is to its Client and this document does not exonerate parties to a transaction from exercising all their rights and obligations under the transaction documents. This document cannot be reproduced, except in full, without prior written approval of the Company. Any unauthorized alteration, forgery or falsification of the content or appearance of this document is unlawful and offenders may be prosecuted to the fullest extent of the law. Unless otherwise stated the results shown in this test report refer only to the sample(s) tested.

## 測試報告

號碼(No.) : CE/2015/20344

日期(Date) : 2015/02/16

頁數(Page): 9 of 65

## Test Report



南亞塑膠工業股份有限公司(台灣) / NAN YA PLASTICS CORPORATION (TAIWAN)

(南亞電子材料(昆山)有限公司 / NAN YA ELECTRONIC MATERIALS (KUNSHAN) CORP., LTD)

(南亞電子材料(惠州)有限公司 / NAN YA ELECTRONIC MATERIALS (HUIZHOU) CORP., LTD)

台灣台北市敦化北路201號 / 201 TUNG HWA NORTH ROAD, TAIPEI, TAIWAN

(江蘇省昆山市市長江南路201號 / 201 CHANG JIANG ROAD(S) KUNSHAN ECONOMIC & TECHNICAL DEVELOPMENT ZONE, JIANG SU)

(廣東省惠州市博羅縣石灣鎮永石大道 / YONGSHI BOULEVARD SHIWAN TOWN BOLUO COUNTY HUIZHOU CITY GUANG DONG)

測試項目 (Test Items)	單位 (Unit)	測試方法 (Method)	方法偵測 極限值 (MDL)	結果 (Result)	限值 (Limit)
				No.1	
鄰苯二甲酸二己酯 / DNHP (Di-n-hexyl phthalate) (CAS No.: 84-75-3)	%	參考EN 14372, 以氣相層析/質譜儀檢測。 / With reference to EN 14372. Analysis was performed by GC/MS.	0.003	n.d.	-
鄰苯二甲酸二(C6-8支鏈與直鏈)烷基酯, 富C7 / DIHP (1,2-Benzenedicarboxylic acid, di-C6-8-branched alkyl esters, C7-rich) (CAS No.: 71888-89-6)	%	參考EN 14372, 以氣相層析/質譜儀檢測。 / With reference to EN 14372. Analysis was performed by GC/MS.	0.01	n.d.	-
鄰苯二甲酸二(C7-11支鏈與直鏈)烷基酯 / DHNUP (1,2-Benzenedicarboxylic acid, di-C7-11-branched and linear alkyl esters) (CAS No.: 68515-42-4)	%	參考EN 14372, 以氣相層析/質譜儀檢測。 / With reference to EN 14372. Analysis was performed by GC/MS.	0.01	n.d.	-
鄰苯二甲酸二(2-甲氧基乙基)酯 / DMEP (Bis (2-methoxyethyl) phthalate) (CAS No.: 117-82-8)	%	參考EN 14372, 以氣相層析/質譜儀檢測。 / With reference to EN 14372. Analysis was performed by GC/MS.	0.003	n.d.	-
鄰苯二甲酸二異戊酯 / DIPP (Diisopentylphthalate) (CAS No.: 605-50-5)	%	參考EN 14372, 以氣相層析/質譜儀檢測。 / With reference to EN 14372. Analysis was performed by GC/MS.	0.003	n.d.	-
支鏈和直鏈1,2-苯二羧二戊酯 / 1,2-Benzenedicarboxylic acid, dipentylester, branched and linear (CAS No.: 84777-06-0)	%	參考EN 14372, 以氣相層析/質譜儀檢測。 / With reference to EN 14372. Analysis was performed by GC/MS.	0.003	n.d.	-
鄰苯二甲酸正戊基異戊基酯 / N-pentyl-isopentylphthalate	%	參考EN 14372, 以氣相層析/質譜儀檢測。 / With reference to EN 14372. Analysis was performed by GC/MS.	0.003	n.d.	-
鄰苯二甲酸二戊酯 / DPP (Di-pentyl phthalate) (CAS No.: 131-18-0)	%	參考EN 14372, 以氣相層析/質譜儀檢測。 / With reference to EN 14372. Analysis was performed by GC/MS.	0.003	n.d.	-

This document is issued by the Company subject to its General Conditions of Service printed overleaf, available on request or accessible at <http://www.sgs.com/en/Terms-and-Conditions.aspx> and, for electronic format documents, subject to Terms and Conditions for Electronic Documents at <http://www.sgs.com/en/Terms-and-Conditions/Termse-Documents.aspx>. Attention is drawn to the limitation of liability, indemnification and jurisdiction issues defined therein. Any holder of this document is advised that information contained hereon reflects the Company's findings at the time of its intervention only and within the limits of client's instruction, if any. The Company's sole responsibility is to its Client and this document does not exonerate parties to a transaction from exercising all their rights and obligations under the transaction documents. This document cannot be reproduced, except in full, without prior written approval of the Company. Any unauthorized alteration, forgery or falsification of the content or appearance of this document is unlawful and offenders may be prosecuted to the fullest extent of the law. Unless otherwise stated the results shown in this test report refer only to the sample(s) tested.



# 測試報告

# Test Report

號碼(No.) : CE/2015/20344

日期(Date) : 2015/02/16

頁數(Page): 10 of 65



南亞塑膠工業股份有限公司(台灣) / NAN YA PLASTICS CORPORATION (TAIWAN)

(南亞電子材料(昆山)有限公司 / NAN YA ELECTRONIC MATERIALS (KUNSHAN) CORP., LTD)

(南亞電子材料(惠州)有限公司 / NAN YA ELECTRONIC MATERIALS (HUIZHOU) CORP., LTD)

台灣台北市敦化北路201號 / 201 TUNG HWA NORTH ROAD, TAIPEI, TAIWAN

(江蘇省昆山市市長江南路201號 / 201 CHANG JIANG ROAD(S) KUNSHAN ECONOMIC & TECHNICAL DEVELOPMENT ZONE, JIANG SU)

(廣東省惠州市博羅縣石灣鎮永石大道 / YONGSHI BOULEVARD SHIWAN TOWN BOLUO COUNTY HUIZHOU CITY GUANG DONG)

測試項目 (Test Items)	單位 (Unit)	測試方法 (Method)	方法偵測 極限值 (MDL)	結果 (Result)	限值 (Limit)
				No.1	
鄰苯二甲酸二正戊酯 / DNPP (Di-n-pentyl phthalate) (CAS No.: 131-18-0)	%	參考EN 14372, 以氣相層析/質譜儀檢測。 / With reference to EN 14372. Analysis was performed by GC/MS.	0.003	n.d.	-
乙二醇二甲醚 / Ethylene glycol dimethyl ether (EGDME) (CAS No.: 110-71-4)	mg/kg	參考US EPA 3550C方法, 以氣相層析/質譜儀檢測。 / With reference to US EPA 3550C method. Analysis was performed by GC/MS.	10	n.d.	-
過氯酸鹽 / Perchlorate (CAS No.: 14797-73-0)	mg/kg	以離子層析儀檢測。 / Analysis was performed by IC.	0.006	n.d.	-
溴甲烷 / Bromomethane (CAS No.: 74-83-9)	mg/kg	參考US EPA 5021方法, 以氣相層析/質譜儀檢測。 / With reference to US EPA 5021 method. Analysis was performed by GC/MS.	1	n.d.	-
<b>鹵素 / Halogen</b>					
鹵素(氯) / Halogen-Chlorine (Cl) (CAS No.: 22537-15-1)	mg/kg	參考BS EN 14582:2007, 以離子層析儀分析。 / With reference to BS EN 14582:2007. Analysis was performed by IC.	50	339	-
鹵素(溴) / Halogen-Bromine (Br) (CAS No.: 10097-32-2)			50	46900	-
鹵素(氟) / Halogen-Fluorine (F) (CAS No.: 14762-94-8)			50	906	-
鹵素(碘) / Halogen-Iodine (I) (CAS No.: 14362-44-8)			50	n.d.	-

This document is issued by the Company subject to its General Conditions of Service printed overleaf, available on request or accessible at <http://www.sgs.com/en/Terms-and-Conditions.aspx> and, for electronic format documents, subject to Terms and Conditions for Electronic Documents at <http://www.sgs.com/en/Terms-and-Conditions/Termse-Documents.aspx>. Attention is drawn to the limitation of liability, indemnification and jurisdiction issues defined therein. Any holder of this document is advised that information contained hereon reflects the Company's findings at the time of its intervention only and within the limits of client's instruction, if any. The Company's sole responsibility is to its Client and this document does not exonerate parties to a transaction from exercising all their rights and obligations under the transaction documents. This document cannot be reproduced, except in full, without prior written approval of the Company. Any unauthorized alteration, forgery or falsification of the content or appearance of this document is unlawful and offenders may be prosecuted to the fullest extent of the law. Unless otherwise stated the results shown in this test report refer only to the sample(s) tested.



# 測試報告

# Test Report

號碼(No.) : CE/2015/20344

日期(Date) : 2015/02/16

頁數(Page): 11 of 65



南亞塑膠工業股份有限公司(台灣) / NAN YA PLASTICS CORPORATION (TAIWAN)  
 (南亞電子材料(昆山)有限公司 / NAN YA ELECTRONIC MATERIALS (KUNSHAN) CORP., LTD)  
 (南亞電子材料(惠州)有限公司 / NAN YA ELECTRONIC MATERIALS (HUIZHOU) CORP., LTD)  
 台灣台北市敦化北路201號 / 201 TUNG HWA NORTH ROAD, TAIPEI, TAIWAN  
 (江蘇省昆山市長江南路201號 / 201 CHANG JIANG ROAD(S) KUNSHAN ECONOMIC & TECHNICAL DEVELOPMENT ZONE, JIANG SU)  
 (廣東省惠州市博羅縣石灣鎮永石大道 / YONGSHI BOULEVARD SHIWAN TOWN BOLUO COUNTY HUIZHOU CITY GUANG DONG)

測試項目 (Test Items)	單位 (Unit)	測試方法 (Method)	方法偵測 極限值 (MDL)	結果 (Result)	限值 (Limit)		
				No.1			
<b>多溴聯苯總和 / Sum of PBBs</b>	mg/kg	參考IEC 62321: 2008方法, 以氣相層析/質譜儀檢測. / With reference to IEC 62321: 2008 and performed by GC/MS.	-	n.d.	1000		
一溴聯苯 / Monobromobiphenyl			5	n.d.	-		
二溴聯苯 / Dibromobiphenyl			5	n.d.	-		
三溴聯苯 / Tribromobiphenyl			5	n.d.	-		
四溴聯苯 / Tetrabromobiphenyl			5	n.d.	-		
五溴聯苯 / Pentabromobiphenyl			5	n.d.	-		
六溴聯苯 / Hexabromobiphenyl			5	n.d.	-		
七溴聯苯 / Heptabromobiphenyl			5	n.d.	-		
八溴聯苯 / Octabromobiphenyl			5	n.d.	-		
九溴聯苯 / Nonabromobiphenyl			5	n.d.	-		
十溴聯苯 / Decabromobiphenyl			5	n.d.	-		
<b>多溴聯苯醚總和 / Sum of PBDEs</b>					-	n.d.	1000
一溴聯苯醚 / Monobromodiphenyl ether					5	n.d.	-
二溴聯苯醚 / Dibromodiphenyl ether					5	n.d.	-
三溴聯苯醚 / Tribromodiphenyl ether					5	n.d.	-
四溴聯苯醚 / Tetrabromodiphenyl ether					5	n.d.	-
五溴聯苯醚 / Pentabromodiphenyl ether					5	n.d.	-
六溴聯苯醚 / Hexabromodiphenyl ether					5	n.d.	-
七溴聯苯醚 / Heptabromodiphenyl ether					5	n.d.	-
八溴聯苯醚 / Octabromodiphenyl ether					5	n.d.	-
九溴聯苯醚 / Nonabromodiphenyl ether			5	n.d.	-		
十溴聯苯醚 / Decabromodiphenyl ether			5	n.d.	-		

This document is issued by the Company subject to its General Conditions of Service printed overleaf, available on request or accessible at <http://www.sgs.com/en/Terms-and-Conditions.aspx> and, for electronic format documents, subject to Terms and Conditions for Electronic Documents at <http://www.sgs.com/en/Terms-and-Conditions/Termse-Documents.aspx>. Attention is drawn to the limitation of liability, indemnification and jurisdiction issues defined therein. Any holder of this document is advised that information contained hereon reflects the Company's findings at the time of its intervention only and within the limits of client's instruction, if any. The Company's sole responsibility is to its Client and this document does not exonerate parties to a transaction from exercising all their rights and obligations under the transaction documents. This document cannot be reproduced, except in full, without prior written approval of the Company. Any unauthorized alteration, forgery or falsification of the content or appearance of this document is unlawful and offenders may be prosecuted to the fullest extent of the law. Unless otherwise stated the results shown in this test report refer only to the sample(s) tested.

## 測試報告

## Test Report

號碼(No.) : CE/2015/20344

日期(Date) : 2015/02/16

頁數(Page): 12 of 65



南亞塑膠工業股份有限公司(台灣) / NAN YA PLASTICS CORPORATION (TAIWAN)

(南亞電子材料(昆山)有限公司 / NAN YA ELECTRONIC MATERIALS (KUNSHAN) CORP., LTD)

(南亞電子材料(惠州)有限公司 / NAN YA ELECTRONIC MATERIALS (HUIZHOU) CORP., LTD)

台灣台北市敦化北路201號 / 201 TUNG HWA NORTH ROAD, TAIPEI, TAIWAN

(江蘇省昆山市市長江南路201號 / 201 CHANG JIANG ROAD(S) KUNSHAN ECONOMIC & TECHNICAL DEVELOPMENT ZONE, JIANG SU)

(廣東省惠州市博羅縣石灣鎮永石大道 / YONGSHI BOULEVARD SHIWAN TOWN BOLUO COUNTY HUIZHOU CITY GUANG DONG)

測試項目 (Test Items)	單位 (Unit)	測試方法 (Method)	方法偵測 極限值 (MDL)	結果 (Result)	限值 (Limit)
				No.1	
<b>有機錫 / Organic-tin compounds</b>					
三丁基錫 / Tributyl Tin (TBT)	mg/kg	參考ISO 17353方法, 以氣相層析儀/火焰光度偵測器檢測. / With reference to ISO 17353. Analysis was performed by GC/FPD.	0.03	n.d.	-
三苯基錫 / Triphenyl Tin (TphT)			0.03	n.d.	-
二丁基錫 / Dibutyl Tin (DBT)			0.03	n.d.	-
二辛基錫 / Dioctyl Tin (DOT)			0.03	n.d.	-
三丁基錫氧化物 / Tributyl Tin Oxide (TBTO)*** (CAS No.: 56-35-9)			-	n.d.	-
<b>偶氮 (AZO)</b>					
1): 4-氨基二苯 / 4-AMINODIPHENYL (CAS No.: 92-67-1)	mg/kg	參考LFGB 82.02-2方法, 以氣相層析/質譜儀檢測. / With reference to LFGB 82.02-2. Analysis was performed by GC/MS.	3	n.d.	-
2): 聯苯胺 / BENZIDINE (CAS No.: 92-87-5)	mg/kg	參考LFGB 82.02-2方法, 以氣相層析/質譜儀檢測. / With reference to LFGB 82.02-2. Analysis was performed by GC/MS.	3	n.d.	-
3): 4-氯鄰甲苯胺 / 4-CHLORO-O-TOLUIDINE (CAS No.: 95-69-2)	mg/kg	參考LFGB 82.02-2方法, 以氣相層析/質譜儀檢測. / With reference to LFGB 82.02-2. Analysis was performed by GC/MS.	3	n.d.	-
4): 2-萘胺 / 2-NAPHTHYLAMINE (CAS No.: 91-59-8)	mg/kg	參考LFGB 82.02-2方法, 以氣相層析/質譜儀檢測. / With reference to LFGB 82.02-2. Analysis was performed by GC/MS.	3	n.d.	-
5): 鄰氨基二甲苯偶氮 / O-AMINOAZOTOLUENE (CAS No.: 97-56-3)	mg/kg	參考LFGB 82.02-2方法, 以氣相層析/質譜儀檢測. / With reference to LFGB 82.02-2. Analysis was performed by GC/MS.	3	n.d.	-

This document is issued by the Company subject to its General Conditions of Service printed overleaf, available on request or accessible at <http://www.sgs.com/en/Terms-and-Conditions.aspx> and, for electronic format documents, subject to Terms and Conditions for Electronic Documents at <http://www.sgs.com/en/Terms-and-Conditions/Termse-Document.aspx>. Attention is drawn to the limitation of liability, indemnification and jurisdiction issues defined therein. Any holder of this document is advised that information contained hereon reflects the Company's findings at the time of its intervention only and within the limits of client's instruction, if any. The Company's sole responsibility is to its Client and this document does not exonerate parties to a transaction from exercising all their rights and obligations under the transaction documents. This document cannot be reproduced, except in full, without prior written approval of the Company. Any unauthorized alteration, forgery or falsification of the content or appearance of this document is unlawful and offenders may be prosecuted to the fullest extent of the law. Unless otherwise stated the results shown in this test report refer only to the sample(s) tested.

# 測試報告

# Test Report

號碼(No.) : CE/2015/20344

日期(Date) : 2015/02/16

頁數(Page): 13 of 65



南亞塑膠工業股份有限公司(台灣) / NAN YA PLASTICS CORPORATION (TAIWAN)

(南亞電子材料(昆山)有限公司 / NAN YA ELECTRONIC MATERIALS (KUNSHAN) CORP., LTD)

(南亞電子材料(惠州)有限公司 / NAN YA ELECTRONIC MATERIALS (HUIZHOU) CORP., LTD)

台灣台北市敦化北路201號 / 201 TUNG HWA NORTH ROAD, TAIPEI, TAIWAN

(江蘇省昆山市長江南路201號 / 201 CHANG JIANG ROAD(S) KUNSHAN ECONOMIC & TECHNICAL DEVELOPMENT ZONE, JIANG SU)

(廣東省惠州市博羅縣石灣鎮永石大道 / YONGSHI BOULEVARD SHIWAN TOWN BOLUO COUNTY HUIZHOU CITY GUANG DONG)

測試項目 (Test Items)	單位 (Unit)	測試方法 (Method)	方法偵測 極限值 (MDL)	結果 (Result)	限值 (Limit)
				No.1	
6): 對硝基鄰甲苯胺 / 2-AMINO-4-NITROTOLUENE (CAS No.: 99-55-8)	mg/kg	參考LFGB 82.02-2方法, 以氣相層析/質譜儀檢測. / With reference to LFGB 82.02-2. Analysis was performed by GC/MS.	3	n.d.	-
7): 對氯苯胺 / P-CHLOROANILINE (CAS No.: 106-47-8)	mg/kg	參考LFGB 82.02-2方法, 以氣相層析/質譜儀檢測. / With reference to LFGB 82.02-2. Analysis was performed by GC/MS.	3	n.d.	-
8): 4-甲氧基-間苯二胺 / 2,4-DIAMINOANISOLE (CAS No.: 615-05-4)	mg/kg	參考LFGB 82.02-2方法, 以氣相層析/質譜儀檢測. / With reference to LFGB 82.02-2. Analysis was performed by GC/MS.	3	n.d.	-
9): 4,4'-二氨基二苯甲烷 / 4,4'-DIAMINODIPHENYLMETHANE (CAS No.: 101-77-9)	mg/kg	參考LFGB 82.02-2方法, 以氣相層析/質譜儀檢測. / With reference to LFGB 82.02-2. Analysis was performed by GC/MS.	3	n.d.	-
10): 3,3'-二氯聯苯胺 / 3,3'-DICHLOROBENZIDINE (CAS No.: 91-94-1)	mg/kg	參考LFGB 82.02-2方法, 以氣相層析/質譜儀檢測. / With reference to LFGB 82.02-2. Analysis was performed by GC/MS.	3	n.d.	-
11): 3,3'-二甲氧基聯苯胺 / 3,3'-DIMETHOXYBENZIDINE (CAS No.: 119-90-4)	mg/kg	參考LFGB 82.02-2方法, 以氣相層析/質譜儀檢測. / With reference to LFGB 82.02-2. Analysis was performed by GC/MS.	3	n.d.	-
12): 3,3'-二甲基聯苯胺 / 3,3'-DIMETHYLBENZIDINE (CAS No.: 119-93-7)	mg/kg	參考LFGB 82.02-2方法, 以氣相層析/質譜儀檢測. / With reference to LFGB 82.02-2. Analysis was performed by GC/MS.	3	n.d.	-

This document is issued by the Company subject to its General Conditions of Service printed overleaf, available on request or accessible at <http://www.sgs.com/en/Terms-and-Conditions.aspx> and, for electronic format documents, subject to Terms and Conditions for Electronic Documents at <http://www.sgs.com/en/Terms-and-Conditions/Termse-Document.aspx>. Attention is drawn to the limitation of liability, indemnification and jurisdiction issues defined therein. Any holder of this document is advised that information contained hereon reflects the Company's findings at the time of its intervention only and within the limits of client's instruction, if any. The Company's sole responsibility is to its Client and this document does not exonerate parties to a transaction from exercising all their rights and obligations under the transaction documents. This document cannot be reproduced, except in full, without prior written approval of the Company. Any unauthorized alteration, forgery or falsification of the content or appearance of this document is unlawful and offenders may be prosecuted to the fullest extent of the law. Unless otherwise stated the results shown in this test report refer only to the sample(s) tested.

# 測試報告

# Test Report

號碼(No.) : CE/2015/20344

日期(Date) : 2015/02/16

頁數(Page): 14 of 65



南亞塑膠工業股份有限公司(台灣) / NAN YA PLASTICS CORPORATION (TAIWAN)  
 (南亞電子材料(昆山)有限公司 / NAN YA ELECTRONIC MATERIALS (KUNSHAN) CORP., LTD)  
 (南亞電子材料(惠州)有限公司 / NAN YA ELECTRONIC MATERIALS (HUIZHOU) CORP., LTD)  
 台灣台北市敦化北路201號 / 201 TUNG HWA NORTH ROAD, TAIPEI, TAIWAN  
 (江蘇省昆山市市長江南路201號 / 201 CHANG JIANG ROAD(S) KUNSHAN ECONOMIC & TECHNICAL DEVELOPMENT ZONE, JIANG SU)  
 (廣東省惠州市博羅縣石灣鎮永石大道 / YONGSHI BOULEVARD SHIWAN TOWN BOLUO COUNTY HUIZHOU CITY GUANG DONG)

測試項目 (Test Items)	單位 (Unit)	測試方法 (Method)	方法偵測 極限值 (MDL)	結果 (Result)	限值 (Limit)
				No. 1	
13): 3,3'-二甲基-4,4'-二氨基二苯甲烷 / 3,3'-DIMETHYL-4,4'-DIAMINODIPHENYLMETHANE (CAS No.: 838-88-0)	mg/kg	參考LFGB 82.02-2方法, 以氣相層析/質譜儀檢測. / With reference to LFGB 82.02-2. Analysis was performed by GC/MS.	3	n.d.	-
14): 2-甲氧基-5-甲基聯苯 / P-CRESIDINE (2-METHOXY-5-METHYLANILINE) (CAS No.: 120-71-8)	mg/kg	參考LFGB 82.02-2方法, 以氣相層析/質譜儀檢測. / With reference to LFGB 82.02-2. Analysis was performed by GC/MS.	3	n.d.	-
15): 4,4'-亞甲基雙(氯苯胺) / 4,4'-METHYLENE-BIS-(2-CHLOROANILINE) (CAS No.: 101-14-4)	mg/kg	參考LFGB 82.02-2方法, 以氣相層析/質譜儀檢測. / With reference to LFGB 82.02-2. Analysis was performed by GC/MS.	3	n.d.	-
16): 4,4'-氧化雙苯胺 / 4,4'-OXYDIANILINE (CAS No.: 101-80-4)	mg/kg	參考LFGB 82.02-2方法, 以氣相層析/質譜儀檢測. / With reference to LFGB 82.02-2. Analysis was performed by GC/MS.	3	n.d.	-
17): 4,4'-硫代雙苯胺 / 4,4'-THIODIANILINE (CAS No.: 139-65-1)	mg/kg	參考LFGB 82.02-2方法, 以氣相層析/質譜儀檢測. / With reference to LFGB 82.02-2. Analysis was performed by GC/MS.	3	n.d.	-
18): 鄰甲苯胺 / O-TOLUIDINE (CAS No.: 95-53-4)	mg/kg	參考LFGB 82.02-2方法, 以氣相層析/質譜儀檢測. / With reference to LFGB 82.02-2. Analysis was performed by GC/MS.	3	n.d.	-
19): 2,4-二氨基甲苯 / 2,4-TOLUYLENEDIAMINE (CAS No.: 95-80-7)	mg/kg	參考LFGB 82.02-2方法, 以氣相層析/質譜儀檢測. / With reference to LFGB 82.02-2. Analysis was performed by GC/MS.	3	n.d.	-

This document is issued by the Company subject to its General Conditions of Service printed overleaf, available on request or accessible at <http://www.sgs.com/en/Terms-and-Conditions.aspx> and, for electronic format documents, subject to Terms and Conditions for Electronic Documents at <http://www.sgs.com/en/Terms-and-Conditions/Termse-Document.aspx>. Attention is drawn to the limitation of liability, indemnification and jurisdiction issues defined therein. Any holder of this document is advised that information contained hereon reflects the Company's findings at the time of its intervention only and within the limits of client's instruction, if any. The Company's sole responsibility is to its Client and this document does not exonerate parties to a transaction from exercising all their rights and obligations under the transaction documents. This document cannot be reproduced, except in full, without prior written approval of the Company. Any unauthorized alteration, forgery or falsification of the content or appearance of this document is unlawful and offenders may be prosecuted to the fullest extent of the law. Unless otherwise stated the results shown in this test report refer only to the sample(s) tested.

# 測試報告

# Test Report

號碼(No.) : CE/2015/20344

日期(Date) : 2015/02/16

頁數(Page): 15 of 65



南亞塑膠工業股份有限公司(台灣) / NAN YA PLASTICS CORPORATION (TAIWAN)

(南亞電子材料(昆山)有限公司 / NAN YA ELECTRONIC MATERIALS (KUNSHAN) CORP., LTD)

(南亞電子材料(惠州)有限公司 / NAN YA ELECTRONIC MATERIALS (HUIZHOU) CORP., LTD)

台灣台北市敦化北路201號 / 201 TUNG HWA NORTH ROAD, TAIPEI, TAIWAN

(江蘇省昆山市長江南路201號 / 201 CHANG JIANG ROAD(S) KUNSHAN ECONOMIC & TECHNICAL DEVELOPMENT ZONE, JIANG SU)

(廣東省惠州市博羅縣石灣鎮永石大道 / YONGSHI BOULEVARD SHIWAN TOWN BOLUO COUNTY HUIZHOU CITY GUANG DONG)

測試項目 (Test Items)	單位 (Unit)	測試方法 (Method)	方法偵測 極限值 (MDL)	結果 (Result)	限值 (Limit)
				No.1	
20): 2,4,5-三甲基苯胺 / 2,4,5-TRIMETHYLANILINE (CAS No.: 137-17-7)	mg/kg	參考LFGB 82.02-2方法, 以氣相層析/質譜儀檢測. / With reference to LFGB 82.02-2. Analysis was performed by GC/MS.	3	n.d.	-
21): 鄰位甲氧基苯胺 / O-ANISIDINE (CAS No.: 90-04-0)	mg/kg	參考LFGB 82.02-2方法, 以氣相層析/質譜儀檢測. / With reference to LFGB 82.02-2. Analysis was performed by GC/MS.	3	n.d.	-
22): 對氨基偶氮苯 / 4-AMINOAZOBENZENE (CAS No.: 60-09-3)	mg/kg	參考LFGB 82.02-2方法, 以氣相層析/質譜儀檢測. / With reference to LFGB 82.02-2. Analysis was performed by GC/MS.	3	n.d.	-
23): 2,4-二甲基苯胺 / 2,4-XYLIDINE (CAS No.: 95-68-1)	mg/kg	參考LFGB 82.02-2方法, 以氣相層析/質譜儀檢測. / With reference to LFGB 82.02-2. Analysis was performed by GC/MS.	3	n.d.	-
24): 2,6-二甲基苯胺 / 2,6-XYLIDINE (CAS No.: 87-62-7)	mg/kg	參考LFGB 82.02-2方法, 以氣相層析/質譜儀檢測. / With reference to LFGB 82.02-2. Analysis was performed by GC/MS.	3	n.d.	-
氫氟碳化物 / HFCs (Hydrofluorocarbon)					
氫氟碳化物 (HFC)-23 (CHF <sub>3</sub> ) (CAS No.: 75-46-7)	mg/kg	參考US EPA 5021方法, 以氣相層析/質譜儀檢測. / With reference to US EPA 5021 method. Analysis was performed by GC/MS.	1	n.d.	-

This document is issued by the Company subject to its General Conditions of Service printed overleaf, available on request or accessible at <http://www.sgs.com/en/Terms-and-Conditions.aspx> and, for electronic format documents, subject to Terms and Conditions for Electronic Documents at <http://www.sgs.com/en/Terms-and-Conditions/Termse-Documents.aspx>. Attention is drawn to the limitation of liability, indemnification and jurisdiction issues defined therein. Any holder of this document is advised that information contained hereon reflects the Company's findings at the time of its intervention only and within the limits of client's instruction, if any. The Company's sole responsibility is to its Client and this document does not exonerate parties to a transaction from exercising all their rights and obligations under the transaction documents. This document cannot be reproduced, except in full, without prior written approval of the Company. Any unauthorized alteration, forgery or falsification of the content or appearance of this document is unlawful and offenders may be prosecuted to the fullest extent of the law. Unless otherwise stated the results shown in this test report refer only to the sample(s) tested.

# 測試報告

號碼(No.) : CE/2015/20344

日期(Date) : 2015/02/16

頁數(Page): 16 of 65

# Test Report



南亞塑膠工業股份有限公司(台灣) / NAN YA PLASTICS CORPORATION (TAIWAN)

(南亞電子材料(昆山)有限公司 / NAN YA ELECTRONIC MATERIALS (KUNSHAN) CORP., LTD)

(南亞電子材料(惠州)有限公司 / NAN YA ELECTRONIC MATERIALS (HUIZHOU) CORP., LTD)

台灣台北市敦化北路201號 / 201 TUNG HWA NORTH ROAD, TAIPEI, TAIWAN

(江蘇省昆山市市長江南路201號 / 201 CHANG JIANG ROAD(S) KUNSHAN ECONOMIC & TECHNICAL DEVELOPMENT ZONE, JIANG SU)

(廣東省惠州市博羅縣石灣鎮永石大道 / YONGSHI BOULEVARD SHIWAN TOWN BOLUO COUNTY HUIZHOU CITY GUANG DONG)

測試項目 (Test Items)	單位 (Unit)	測試方法 (Method)	方法偵測 極限值 (MDL)	結果 (Result)	限值 (Limit)
				No.1	
氫氟碳化物 (HFC)-32 (CH <sub>2</sub> F <sub>2</sub> ) (CAS No.: 75-10-5)	mg/kg	參考US EPA 5021方法, 以氣相層析/質譜儀檢測. / With reference to US EPA 5021 method. Analysis was performed by GC/MS.	1	n.d.	-
氫氟碳化物 (HFC)-41 (CH <sub>3</sub> F) (CAS No.: 593-53-3)	mg/kg	參考US EPA 5021方法, 以氣相層析/質譜儀檢測. / With reference to US EPA 5021 method. Analysis was performed by GC/MS.	1	n.d.	-
氫氟碳化物 (HFC)-43-10mee (C <sub>5</sub> H <sub>2</sub> F <sub>10</sub> )	mg/kg	參考US EPA 5021方法, 以氣相層析/質譜儀檢測. / With reference to US EPA 5021 method. Analysis was performed by GC/MS.	1	n.d.	-
氫氟碳化物 (HFC)-125 (C <sub>2</sub> H <sub>2</sub> F <sub>5</sub> )	mg/kg	參考US EPA 5021方法, 以氣相層析/質譜儀檢測. / With reference to US EPA 5021 method. Analysis was performed by GC/MS.	1	n.d.	-
氫氟碳化物 (HFC)-134 (C <sub>2</sub> H <sub>2</sub> F <sub>4</sub> )	mg/kg	參考US EPA 5021方法, 以氣相層析/質譜儀檢測. / With reference to US EPA 5021 method. Analysis was performed by GC/MS.	1	n.d.	-
氫氟碳化物 (HFC)-134a (CH <sub>2</sub> FCF <sub>3</sub> ) (CAS No.: 811-97-2)	mg/kg	參考US EPA 5021方法, 以氣相層析/質譜儀檢測. / With reference to US EPA 5021 method. Analysis was performed by GC/MS.	1	n.d.	-
氫氟碳化物 (HFC)-143 (CH <sub>3</sub> F <sub>3</sub> )	mg/kg	參考US EPA 5021方法, 以氣相層析/質譜儀檢測. / With reference to US EPA 5021 method. Analysis was performed by GC/MS.	1	n.d.	-

This document is issued by the Company subject to its General Conditions of Service printed overleaf, available on request or accessible at <http://www.sgs.com/en/Terms-and-Conditions.aspx> and, for electronic format documents, subject to Terms and Conditions for Electronic Documents at <http://www.sgs.com/en/Terms-and-Conditions/Termse-Documents.aspx>. Attention is drawn to the limitation of liability, indemnification and jurisdiction issues defined therein. Any holder of this document is advised that information contained hereon reflects the Company's findings at the time of its intervention only and within the limits of client's instruction, if any. The Company's sole responsibility is to its Client and this document does not exonerate parties to a transaction from exercising all their rights and obligations under the transaction documents. This document cannot be reproduced, except in full, without prior written approval of the Company. Any unauthorized alteration, forgery or falsification of the content or appearance of this document is unlawful and offenders may be prosecuted to the fullest extent of the law. Unless otherwise stated the results shown in this test report refer only to the sample(s) tested.



## 測試報告

## Test Report

號碼(No.) : CE/2015/20344

日期(Date) : 2015/02/16

頁數(Page): 17 of 65



南亞塑膠工業股份有限公司(台灣) / NAN YA PLASTICS CORPORATION (TAIWAN)

(南亞電子材料(昆山)有限公司 / NAN YA ELECTRONIC MATERIALS (KUNSHAN) CORP., LTD)

(南亞電子材料(惠州)有限公司 / NAN YA ELECTRONIC MATERIALS (HUIZHOU) CORP., LTD)

台灣台北市敦化北路201號 / 201 TUNG HWA NORTH ROAD, TAIPEI, TAIWAN

(江蘇省昆山市長江南路201號 / 201 CHANG JIANG ROAD(S) KUNSHAN ECONOMIC & TECHNICAL DEVELOPMENT ZONE, JIANG SU)

(廣東省惠州市博羅縣石灣鎮永石大道 / YONGSHI BOULEVARD SHIWAN TOWN BOLUO COUNTY HUIZHOU CITY GUANG DONG)

測試項目 (Test Items)	單位 (Unit)	測試方法 (Method)	方法偵測 極限值 (MDL)	結果 (Result)	限值 (Limit)
				No.1	
氫氟碳化物 (HFC)-143a (CH3F3)	mg/kg	參考US EPA 5021方法, 以氣相層析/質譜儀檢測. / With reference to US EPA 5021 method. Analysis was performed by GC/MS.	1	n.d.	-
氫氟碳化物 (HFC)-152a (C2H4F2) (CAS No.: 75-37-6)	mg/kg	參考US EPA 5021方法, 以氣相層析/質譜儀檢測. / With reference to US EPA 5021 method. Analysis was performed by GC/MS.	1	n.d.	-
氫氟碳化物 (HFC)-227ea (C3HF7) (CAS No.: 431-89-0)	mg/kg	參考US EPA 5021方法, 以氣相層析/質譜儀檢測. / With reference to US EPA 5021 method. Analysis was performed by GC/MS.	1	n.d.	-
氫氟碳化物 (HFC)-236fa (C3H2F6)	mg/kg	參考US EPA 5021方法, 以氣相層析/質譜儀檢測. / With reference to US EPA 5021 method. Analysis was performed by GC/MS.	1	n.d.	-
氫氟碳化物 (HFC)-236ea (C3H2F6) (CAS No.: 431-63-0)	mg/kg	參考US EPA 5021方法, 以氣相層析/質譜儀檢測. / With reference to US EPA 5021 method. Analysis was performed by GC/MS.	1	n.d.	-
氫氟碳化物 (HFC)-245ca (C3H3F5)	mg/kg	參考US EPA 5021方法, 以氣相層析/質譜儀檢測. / With reference to US EPA 5021 method. Analysis was performed by GC/MS.	1	n.d.	-
氫氟碳化物 (HFC)-245fa (C3H3F5)	mg/kg	參考US EPA 5021方法, 以氣相層析/質譜儀檢測. / With reference to US EPA 5021 method. Analysis was performed by GC/MS.	1	n.d.	-

This document is issued by the Company subject to its General Conditions of Service printed overleaf, available on request or accessible at <http://www.sgs.com/en/Terms-and-Conditions.aspx> and, for electronic format documents, subject to Terms and Conditions for Electronic Documents at <http://www.sgs.com/en/Terms-and-Conditions/Termse-Documents.aspx>. Attention is drawn to the limitation of liability, indemnification and jurisdiction issues defined therein. Any holder of this document is advised that information contained hereon reflects the Company's findings at the time of its intervention only and within the limits of client's instruction, if any. The Company's sole responsibility is to its Client and this document does not exonerate parties to a transaction from exercising all their rights and obligations under the transaction documents. This document cannot be reproduced, except in full, without prior written approval of the Company. Any unauthorized alteration, forgery or falsification of the content or appearance of this document is unlawful and offenders may be prosecuted to the fullest extent of the law. Unless otherwise stated the results shown in this test report refer only to the sample(s) tested.

# 測試報告

號碼(No.) : CE/2015/20344

日期(Date) : 2015/02/16

頁數(Page): 18 of 65

# Test Report



南亞塑膠工業股份有限公司(台灣) / NAN YA PLASTICS CORPORATION (TAIWAN)  
 (南亞電子材料(昆山)有限公司 / NAN YA ELECTRONIC MATERIALS (KUNSHAN) CORP., LTD)  
 (南亞電子材料(惠州)有限公司 / NAN YA ELECTRONIC MATERIALS (HUIZHOU) CORP., LTD)  
 台灣台北市敦化北路201號 / 201 TUNG HWA NORTH ROAD, TAIPEI, TAIWAN  
 (江蘇省昆山市市長江南路201號 / 201 CHANG JIANG ROAD(S) KUNSHAN ECONOMIC & TECHNICAL DEVELOPMENT ZONE, JIANG SU)  
 (廣東省惠州市博羅縣石灣鎮永石大道 / YONGSHI BOULEVARD SHIWAN TOWN BOLUO COUNTY HUIZHOU CITY GUANG DONG)

測試項目 (Test Items)	單位 (Unit)	測試方法 (Method)	方法偵測 極限值 (MDL)	結果 (Result)	限值 (Limit)
				No.1	
氫氟碳化物 (HFC)-365mfc (C4H5F5)	mg/kg	參考US EPA 5021方法, 以氣相層析/質譜儀檢測. / With reference to US EPA 5021 method. Analysis was performed by GC/MS.	1	n.d.	-
<b>全氟碳化物 / PFCs (Perfluorocarbon)</b>					
四氟甲烷 / F14 (CAS No.: 75-73-0)	mg/kg	參考US EPA 5021方法, 以氣相層析/質譜儀檢測. / With reference to US EPA 5021 method. Analysis was performed by GC/MS.	1	n.d.	-
六氟乙烷 / Fluorocarbon 116 (CAS No.: 76-16-4)	mg/kg	參考US EPA 5021方法, 以氣相層析/質譜儀檢測. / With reference to US EPA 5021 method. Analysis was performed by GC/MS.	1	n.d.	-
八氟丙烷 / Freon 218 (CAS No.: 76-19-7)	mg/kg	參考US EPA 5021方法, 以氣相層析/質譜儀檢測. / With reference to US EPA 5021 method. Analysis was performed by GC/MS.	1	n.d.	-
十氟丁烷 / Decafluorobutane (CAS No.: 355-25-9)	mg/kg	參考US EPA 5021方法, 以氣相層析/質譜儀檢測. / With reference to US EPA 5021 method. Analysis was performed by GC/MS.	1	n.d.	-
八氟環丁烷 / Freon C318 (CAS No.: 115-25-3)	mg/kg	參考US EPA 5021方法, 以氣相層析/質譜儀檢測. / With reference to US EPA 5021 method. Analysis was performed by GC/MS.	1	n.d.	-
全氟-1-丁烯 / Perfluor-1-butene (CAS No.: 357-26-6)	mg/kg	參考US EPA 5021方法, 以氣相層析/質譜儀檢測. / With reference to US EPA 5021 method. Analysis was performed by GC/MS.	1	n.d.	-

This document is issued by the Company subject to its General Conditions of Service printed overleaf, available on request or accessible at <http://www.sgs.com/en/Terms-and-Conditions.aspx> and, for electronic format documents, subject to Terms and Conditions for Electronic Documents at <http://www.sgs.com/en/Terms-and-Conditions/Termse-Document.aspx>. Attention is drawn to the limitation of liability, indemnification and jurisdiction issues defined therein. Any holder of this document is advised that information contained hereon reflects the Company's findings at the time of its intervention only and within the limits of client's instruction, if any. The Company's sole responsibility is to its Client and this document does not exonerate parties to a transaction from exercising all their rights and obligations under the transaction documents. This document cannot be reproduced, except in full, without prior written approval of the Company. Any unauthorized alteration, forgery or falsification of the content or appearance of this document is unlawful and offenders may be prosecuted to the fullest extent of the law. Unless otherwise stated the results shown in this test report refer only to the sample(s) tested.

# 測試報告

# Test Report

號碼(No.) : CE/2015/20344

日期(Date) : 2015/02/16

頁數(Page): 19 of 65



南亞塑膠工業股份有限公司(台灣) / NAN YA PLASTICS CORPORATION (TAIWAN)

(南亞電子材料(昆山)有限公司 / NAN YA ELECTRONIC MATERIALS (KUNSHAN) CORP., LTD)

(南亞電子材料(惠州)有限公司 / NAN YA ELECTRONIC MATERIALS (HUIZHOU) CORP., LTD)

台灣台北市敦化北路201號 / 201 TUNG HWA NORTH ROAD, TAIPEI, TAIWAN

(江蘇省昆山市長江南路201號 / 201 CHANG JIANG ROAD(S) KUNSHAN ECONOMIC & TECHNICAL DEVELOPMENT ZONE, JIANG SU)

(廣東省惠州市博羅縣石灣鎮永石大道 / YONGSHI BOULEVARD SHIWAN TOWN BOLUO COUNTY HUIZHOU CITY GUANG DONG)

測試項目 (Test Items)	單位 (Unit)	測試方法 (Method)	方法偵測 極限值 (MDL)	結果 (Result)	限值 (Limit)
				No.1	
全氟異丁烯 / perfluorisobutene (CAS No.: 382-21-8)	mg/kg	參考US EPA 5021方法, 以氣相層析/質譜儀檢測. / With reference to US EPA 5021 method. Analysis was performed by GC/MS.	1	n.d.	-
1,4-二氫八氟丁烷 / 1,4-dihydrooctafluorobutane (CAS No.: 377-36-6)	mg/kg	參考US EPA 5021方法, 以氣相層析/質譜儀檢測. / With reference to US EPA 5021 method. Analysis was performed by GC/MS.	1	n.d.	-
2-全氟甲基丁烷 / nonafluor-2-(trifluoromethyl)butane (CAS No.: 594-91-2)	mg/kg	參考US EPA 5021方法, 以氣相層析/質譜儀檢測. / With reference to US EPA 5021 method. Analysis was performed by GC/MS.	1	n.d.	-
全氟戊烷 / perfluoro-n-pentane (CAS No.: 678-26-2)	mg/kg	參考US EPA 5021方法, 以氣相層析/質譜儀檢測. / With reference to US EPA 5021 method. Analysis was performed by GC/MS.	1	n.d.	-
2-全氟甲基戊烷 / 2-perfluoromethylpentane (CAS No.: 355-04-4)	mg/kg	參考US EPA 5021方法, 以氣相層析/質譜儀檢測. / With reference to US EPA 5021 method. Analysis was performed by GC/MS.	1	n.d.	-
全氟己烷 / perfluorohexane (CAS No.: 355-42-0)	mg/kg	參考US EPA 5021方法, 以氣相層析/質譜儀檢測. / With reference to US EPA 5021 method. Analysis was performed by GC/MS.	1	n.d.	-

This document is issued by the Company subject to its General Conditions of Service printed overleaf, available on request or accessible at <http://www.sgs.com/en/Terms-and-Conditions.aspx> and, for electronic format documents, subject to Terms and Conditions for Electronic Documents at <http://www.sgs.com/en/Terms-and-Conditions/Termse-Documents.aspx>. Attention is drawn to the limitation of liability, indemnification and jurisdiction issues defined therein. Any holder of this document is advised that information contained hereon reflects the Company's findings at the time of its intervention only and within the limits of client's instruction, if any. The Company's sole responsibility is to its Client and this document does not exonerate parties to a transaction from exercising all their rights and obligations under the transaction documents. This document cannot be reproduced, except in full, without prior written approval of the Company. Any unauthorized alteration, forgery or falsification of the content or appearance of this document is unlawful and offenders may be prosecuted to the fullest extent of the law. Unless otherwise stated the results shown in this test report refer only to the sample(s) tested.

# 測試報告

# Test Report

號碼(No.) : CE/2015/20344

日期(Date) : 2015/02/16

頁數(Page): 20 of 65



南亞塑膠工業股份有限公司(台灣) / NAN YA PLASTICS CORPORATION (TAIWAN)

(南亞電子材料(昆山)有限公司 / NAN YA ELECTRONIC MATERIALS (KUNSHAN) CORP., LTD)

(南亞電子材料(惠州)有限公司 / NAN YA ELECTRONIC MATERIALS (HUIZHOU) CORP., LTD)

台灣台北市敦化北路201號 / 201 TUNG HWA NORTH ROAD, TAIPEI, TAIWAN

(江蘇省昆山市市長江南路201號 / 201 CHANG JIANG ROAD(S) KUNSHAN ECONOMIC & TECHNICAL DEVELOPMENT ZONE, JIANG SU)

(廣東省惠州市博羅縣石灣鎮永石大道 / YONGSHI BOULEVARD SHIWAN TOWN BOLUO COUNTY HUIZHOU CITY GUANG DONG)

測試項目 (Test Items)	單位 (Unit)	測試方法 (Method)	方法偵測 極限值 (MDL)	結果 (Result)	限值 (Limit)
				No.1	
氟氯碳化物 / CFCs (Chlorofluorocarbons)					
Group I					
氟氯碳化物 (Chlorofluorocarbon)-11 (CAS No.: 75-69-4)	mg/kg	參考US EPA 5021方法, 以氣相層析/質譜儀檢測. / With reference to US EPA 5021 method. Analysis was performed by GC/MS.	1	n.d.	-
氟氯碳化物 (Chlorofluorocarbon)-12 (CAS No.: 75-71-8)	mg/kg	參考US EPA 5021方法, 以氣相層析/質譜儀檢測. / With reference to US EPA 5021 method. Analysis was performed by GC/MS.	1	n.d.	-
氟氯碳化物 (Chlorofluorocarbon)-113 (CAS No.: 76-13-1)	mg/kg	參考US EPA 5021方法, 以氣相層析/質譜儀檢測. / With reference to US EPA 5021 method. Analysis was performed by GC/MS.	1	n.d.	-
氟氯碳化物 (Chlorofluorocarbon)-114 (CAS No.: 76-14-2)	mg/kg	參考US EPA 5021方法, 以氣相層析/質譜儀檢測. / With reference to US EPA 5021 method. Analysis was performed by GC/MS.	1	n.d.	-
氟氯碳化物 (Chlorofluorocarbon)-115 (CAS No.: 76-15-3)	mg/kg	參考US EPA 5021方法, 以氣相層析/質譜儀檢測. / With reference to US EPA 5021 method. Analysis was performed by GC/MS.	1	n.d.	-
Group III					
氟氯碳化物 (Chlorofluorocarbon)-13 (CAS No.: 75-72-9)	mg/kg	參考US EPA 5021方法, 以氣相層析/質譜儀檢測. / With reference to US EPA 5021 method. Analysis was performed by GC/MS.	1	n.d.	-

This document is issued by the Company subject to its General Conditions of Service printed overleaf, available on request or accessible at <http://www.sgs.com/en/Terms-and-Conditions.aspx> and, for electronic format documents, subject to Terms and Conditions for Electronic Documents at <http://www.sgs.com/en/Terms-and-Conditions/Termse-Documents.aspx>. Attention is drawn to the limitation of liability, indemnification and jurisdiction issues defined therein. Any holder of this document is advised that information contained hereon reflects the Company's findings at the time of its intervention only and within the limits of client's instruction, if any. The Company's sole responsibility is to its Client and this document does not exonerate parties to a transaction from exercising all their rights and obligations under the transaction documents. This document cannot be reproduced, except in full, without prior written approval of the Company. Any unauthorized alteration, forgery or falsification of the content or appearance of this document is unlawful and offenders may be prosecuted to the fullest extent of the law. Unless otherwise stated the results shown in this test report refer only to the sample(s) tested.

## 測試報告

## Test Report

號碼(No.) : CE/2015/20344

日期(Date) : 2015/02/16

頁數(Page): 21 of 65



南亞塑膠工業股份有限公司(台灣) / NAN YA PLASTICS CORPORATION (TAIWAN)

(南亞電子材料(昆山)有限公司 / NAN YA ELECTRONIC MATERIALS (KUNSHAN) CORP., LTD)

(南亞電子材料(惠州)有限公司 / NAN YA ELECTRONIC MATERIALS (HUIZHOU) CORP., LTD)

台灣台北市敦化北路201號 / 201 TUNG HWA NORTH ROAD, TAIPEI, TAIWAN

(江蘇省昆山市長江南路201號 / 201 CHANG JIANG ROAD(S) KUNSHAN ECONOMIC & TECHNICAL DEVELOPMENT ZONE, JIANG SU)

(廣東省惠州市博羅縣石灣鎮永石大道 / YONGSHI BOULEVARD SHIWAN TOWN BOLUO COUNTY HUIZHOU CITY GUANG DONG)

測試項目 (Test Items)	單位 (Unit)	測試方法 (Method)	方法偵測 極限值 (MDL)	結果 (Result)	限值 (Limit)
				No.1	
氟氯碳化物 (Chlorofluorocarbon)-111 (CAS No.: 354-56-3)	mg/kg	參考US EPA 5021方法, 以氣相層析/質譜儀檢測. / With reference to US EPA 5021 method. Analysis was performed by GC/MS.	1	n.d.	-
氟氯碳化物 (Chlorofluorocarbon)-112 (CAS No.: 76-12-0)	mg/kg	參考US EPA 5021方法, 以氣相層析/質譜儀檢測. / With reference to US EPA 5021 method. Analysis was performed by GC/MS.	1	n.d.	-
氟氯碳化物 (Chlorofluorocarbon)-211 (CAS No.: 422-78-6)	mg/kg	參考US EPA 5021方法, 以氣相層析/質譜儀檢測. / With reference to US EPA 5021 method. Analysis was performed by GC/MS.	1	n.d.	-
氟氯碳化物 (Chlorofluorocarbon)-212 (CAS No.: 3182-26-1)	mg/kg	參考US EPA 5021方法, 以氣相層析/質譜儀檢測. / With reference to US EPA 5021 method. Analysis was performed by GC/MS.	1	n.d.	-
氟氯碳化物 (Chlorofluorocarbon)-213 (CAS No.: 2354-06-5)	mg/kg	參考US EPA 5021方法, 以氣相層析/質譜儀檢測. / With reference to US EPA 5021 method. Analysis was performed by GC/MS.	1	n.d.	-
氟氯碳化物 (Chlorofluorocarbon)-214 (CAS No.: 29255-31-0)	mg/kg	參考US EPA 5021方法, 以氣相層析/質譜儀檢測. / With reference to US EPA 5021 method. Analysis was performed by GC/MS.	1	n.d.	-
氟氯碳化物 (Chlorofluorocarbon)-215 (CAS No.: 4259-43-2)	mg/kg	參考US EPA 5021方法, 以氣相層析/質譜儀檢測. / With reference to US EPA 5021 method. Analysis was performed by GC/MS.	1	n.d.	-

This document is issued by the Company subject to its General Conditions of Service printed overleaf, available on request or accessible at <http://www.sgs.com/en/Terms-and-Conditions.aspx> and, for electronic format documents, subject to Terms and Conditions for Electronic Documents at <http://www.sgs.com/en/Terms-and-Conditions/Termse-Documents.aspx>. Attention is drawn to the limitation of liability, indemnification and jurisdiction issues defined therein. Any holder of this document is advised that information contained hereon reflects the Company's findings at the time of its intervention only and within the limits of client's instruction, if any. The Company's sole responsibility is to its Client and this document does not exonerate parties to a transaction from exercising all their rights and obligations under the transaction documents. This document cannot be reproduced, except in full, without prior written approval of the Company. Any unauthorized alteration, forgery or falsification of the content or appearance of this document is unlawful and offenders may be prosecuted to the fullest extent of the law. Unless otherwise stated the results shown in this test report refer only to the sample(s) tested.

# 測試報告

號碼(No.) : CE/2015/20344

日期(Date) : 2015/02/16

頁數(Page): 22 of 65

# Test Report



南亞塑膠工業股份有限公司(台灣) / NAN YA PLASTICS CORPORATION (TAIWAN)

(南亞電子材料(昆山)有限公司 / NAN YA ELECTRONIC MATERIALS (KUNSHAN) CORP., LTD)

(南亞電子材料(惠州)有限公司 / NAN YA ELECTRONIC MATERIALS (HUIZHOU) CORP., LTD)

台灣台北市敦化北路201號 / 201 TUNG HWA NORTH ROAD, TAIPEI, TAIWAN

(江蘇省昆山市長江南路201號 / 201 CHANG JIANG ROAD(S) KUNSHAN ECONOMIC & TECHNICAL DEVELOPMENT ZONE, JIANG SU)

(廣東省惠州市博羅縣石灣鎮永石大道 / YONGSHI BOULEVARD SHIWAN TOWN BOLUO COUNTY HUIZHOU CITY GUANG DONG)

測試項目 (Test Items)	單位 (Unit)	測試方法 (Method)	方法偵測 極限值 (MDL)	結果 (Result)	限值 (Limit)
				No.1	
氟氯碳化物 (Chlorofluorocarbon)-216 (CAS No.: 661-97-2)	mg/kg	參考US EPA 5021方法, 以氣相層析/質譜儀檢測. / With reference to US EPA 5021 method. Analysis was performed by GC/MS.	1	n.d.	-
氟氯碳化物 (Chlorofluorocarbon)-217 (CAS No.: 422-86-6)	mg/kg	參考US EPA 5021方法, 以氣相層析/質譜儀檢測. / With reference to US EPA 5021 method. Analysis was performed by GC/MS.	1	n.d.	-
<b>氟氯氫碳化物 / HCFCs (Hydrochlorofluorocarbons)</b>					
氟氯氫碳化物 (HCFC)-21 (CAS No.: 75-43-4)	mg/kg	參考US EPA 5021方法, 以氣相層析/質譜儀檢測. / With reference to US EPA 5021 method. Analysis was performed by GC/MS.	1	n.d.	-
氟氯氫碳化物 (HCFC)-22 (CAS No.: 75-45-6)	mg/kg	參考US EPA 5021方法, 以氣相層析/質譜儀檢測. / With reference to US EPA 5021 method. Analysis was performed by GC/MS.	1	n.d.	-
氟氯氫碳化物 (HCFC)-31 (CAS No.: 593-70-4)	mg/kg	參考US EPA 5021方法, 以氣相層析/質譜儀檢測. / With reference to US EPA 5021 method. Analysis was performed by GC/MS.	1	n.d.	-
氟氯氫碳化物 (HCFC)-121 (CAS No.: 354-14-3)	mg/kg	參考US EPA 5021方法, 以氣相層析/質譜儀檢測. / With reference to US EPA 5021 method. Analysis was performed by GC/MS.	1	n.d.	-

This document is issued by the Company subject to its General Conditions of Service printed overleaf, available on request or accessible at <http://www.sgs.com/en/Terms-and-Conditions.aspx> and, for electronic format documents, subject to Terms and Conditions for Electronic Documents at <http://www.sgs.com/en/Terms-and-Conditions/Termse-Documents.aspx>. Attention is drawn to the limitation of liability, indemnification and jurisdiction issues defined therein. Any holder of this document is advised that information contained hereon reflects the Company's findings at the time of its intervention only and within the limits of client's instruction, if any. The Company's sole responsibility is to its Client and this document does not exonerate parties to a transaction from exercising all their rights and obligations under the transaction documents. This document cannot be reproduced, except in full, without prior written approval of the Company. Any unauthorized alteration, forgery or falsification of the content or appearance of this document is unlawful and offenders may be prosecuted to the fullest extent of the law. Unless otherwise stated the results shown in this test report refer only to the sample(s) tested.



# 測試報告

# Test Report

號碼(No.) : CE/2015/20344

日期(Date) : 2015/02/16

頁數(Page): 23 of 65



南亞塑膠工業股份有限公司(台灣) / NAN YA PLASTICS CORPORATION (TAIWAN)

(南亞電子材料(昆山)有限公司 / NAN YA ELECTRONIC MATERIALS (KUNSHAN) CORP., LTD)

(南亞電子材料(惠州)有限公司 / NAN YA ELECTRONIC MATERIALS (HUIZHOU) CORP., LTD)

台灣台北市敦化北路201號 / 201 TUNG HWA NORTH ROAD, TAIPEI, TAIWAN

(江蘇省昆山市長江南路201號 / 201 CHANG JIANG ROAD(S) KUNSHAN ECONOMIC & TECHNICAL DEVELOPMENT ZONE, JIANG SU)

(廣東省惠州市博羅縣石灣鎮永石大道 / YONGSHI BOULEVARD SHIWAN TOWN BOLUO COUNTY HUIZHOU CITY GUANG DONG)

測試項目 (Test Items)	單位 (Unit)	測試方法 (Method)	方法偵測 極限值 (MDL)	結果 (Result)	限值 (Limit)
				No.1	
氟氯氫碳化物 (HCFC)-122 (CAS No.: 354-21-2)	mg/kg	參考US EPA 5021方法, 以氣相層析/質譜儀檢測. / With reference to US EPA 5021 method. Analysis was performed by GC/MS.	1	n.d.	-
氟氯氫碳化物 (HCFC)-123 (CAS No.: 306-83-2)	mg/kg	參考US EPA 5021方法, 以氣相層析/質譜儀檢測. / With reference to US EPA 5021 method. Analysis was performed by GC/MS.	1	n.d.	-
氟氯氫碳化物 (HCFC)-124 (CAS No.: 2837-89-0)	mg/kg	參考US EPA 5021方法, 以氣相層析/質譜儀檢測. / With reference to US EPA 5021 method. Analysis was performed by GC/MS.	1	n.d.	-
氟氯氫碳化物 (HCFC)-131 (CAS No.: 359-28-4)	mg/kg	參考US EPA 5021方法, 以氣相層析/質譜儀檢測. / With reference to US EPA 5021 method. Analysis was performed by GC/MS.	1	n.d.	-
氟氯氫碳化物 (HCFC)-132b (CAS No.: 1649-08-7)	mg/kg	參考US EPA 5021方法, 以氣相層析/質譜儀檢測. / With reference to US EPA 5021 method. Analysis was performed by GC/MS.	1	n.d.	-
氟氯氫碳化物 (HCFC)-133a (CAS No.: 75-88-7)	mg/kg	參考US EPA 5021方法, 以氣相層析/質譜儀檢測. / With reference to US EPA 5021 method. Analysis was performed by GC/MS.	1	n.d.	-
氟氯氫碳化物 (HCFC)-141b (CAS No.: 1717-00-6)	mg/kg	參考US EPA 5021方法, 以氣相層析/質譜儀檢測. / With reference to US EPA 5021 method. Analysis was performed by GC/MS.	1	n.d.	-

This document is issued by the Company subject to its General Conditions of Service printed overleaf, available on request or accessible at <http://www.sgs.com/en/Terms-and-Conditions.aspx> and, for electronic format documents, subject to Terms and Conditions for Electronic Documents at <http://www.sgs.com/en/Terms-and-Conditions/Termse-Documents.aspx>. Attention is drawn to the limitation of liability, indemnification and jurisdiction issues defined therein. Any holder of this document is advised that information contained hereon reflects the Company's findings at the time of its intervention only and within the limits of client's instruction, if any. The Company's sole responsibility is to its Client and this document does not exonerate parties to a transaction from exercising all their rights and obligations under the transaction documents. This document cannot be reproduced, except in full, without prior written approval of the Company. Any unauthorized alteration, forgery or falsification of the content or appearance of this document is unlawful and offenders may be prosecuted to the fullest extent of the law. Unless otherwise stated the results shown in this test report refer only to the sample(s) tested.

# 測試報告

# Test Report

號碼(No.) : CE/2015/20344

日期(Date) : 2015/02/16

頁數(Page): 24 of 65



南亞塑膠工業股份有限公司(台灣) / NAN YA PLASTICS CORPORATION (TAIWAN)

(南亞電子材料(昆山)有限公司 / NAN YA ELECTRONIC MATERIALS (KUNSHAN) CORP., LTD)

(南亞電子材料(惠州)有限公司 / NAN YA ELECTRONIC MATERIALS (HUIZHOU) CORP., LTD)

台灣台北市敦化北路201號 / 201 TUNG HWA NORTH ROAD, TAIPEI, TAIWAN

(江蘇省昆山市長江南路201號 / 201 CHANG JIANG ROAD(S) KUNSHAN ECONOMIC & TECHNICAL DEVELOPMENT ZONE, JIANG SU)

(廣東省惠州市博羅縣石灣鎮永石大道 / YONGSHI BOULEVARD SHIWAN TOWN BOLUO COUNTY HUIZHOU CITY GUANG DONG)

測試項目 (Test Items)	單位 (Unit)	測試方法 (Method)	方法偵測 極限值 (MDL)	結果 (Result)	限值 (Limit)
				No.1	
氟氯氫碳化物 (HCFC)-142b (CAS No.: 75-68-3)	mg/kg	參考US EPA 5021方法, 以氣相層析/質譜儀檢測. / With reference to US EPA 5021 method. Analysis was performed by GC/MS.	1	n.d.	-
氟氯氫碳化物 (HCFC)-221 (CAS No.: 422-26-4)	mg/kg	參考US EPA 5021方法, 以氣相層析/質譜儀檢測. / With reference to US EPA 5021 method. Analysis was performed by GC/MS.	1	n.d.	-
氟氯氫碳化物 (HCFC)-222 (CAS No.: 422-49-1)	mg/kg	參考US EPA 5021方法, 以氣相層析/質譜儀檢測. / With reference to US EPA 5021 method. Analysis was performed by GC/MS.	1	n.d.	-
氟氯氫碳化物 (HCFC)-223 (CAS No.: 422-52-6)	mg/kg	參考US EPA 5021方法, 以氣相層析/質譜儀檢測. / With reference to US EPA 5021 method. Analysis was performed by GC/MS.	1	n.d.	-
氟氯氫碳化物 (HCFC)-224 (CAS No.: 422-54-8)	mg/kg	參考US EPA 5021方法, 以氣相層析/質譜儀檢測. / With reference to US EPA 5021 method. Analysis was performed by GC/MS.	1	n.d.	-
氟氯氫碳化物 (HCFC)-225ca (CAS No.: 422-56-0)	mg/kg	參考US EPA 5021方法, 以氣相層析/質譜儀檢測. / With reference to US EPA 5021 method. Analysis was performed by GC/MS.	1	n.d.	-
氟氯氫碳化物 (HCFC)-225cb (CAS No.: 507-55-1)	mg/kg	參考US EPA 5021方法, 以氣相層析/質譜儀檢測. / With reference to US EPA 5021 method. Analysis was performed by GC/MS.	1	n.d.	-

This document is issued by the Company subject to its General Conditions of Service printed overleaf, available on request or accessible at <http://www.sgs.com/en/Terms-and-Conditions.aspx> and, for electronic format documents, subject to Terms and Conditions for Electronic Documents at <http://www.sgs.com/en/Terms-and-Conditions/Termse-Documents.aspx>. Attention is drawn to the limitation of liability, indemnification and jurisdiction issues defined therein. Any holder of this document is advised that information contained hereon reflects the Company's findings at the time of its intervention only and within the limits of client's instruction, if any. The Company's sole responsibility is to its Client and this document does not exonerate parties to a transaction from exercising all their rights and obligations under the transaction documents. This document cannot be reproduced, except in full, without prior written approval of the Company. Any unauthorized alteration, forgery or falsification of the content or appearance of this document is unlawful and offenders may be prosecuted to the fullest extent of the law. Unless otherwise stated the results shown in this test report refer only to the sample(s) tested.

# 測試報告

# Test Report

號碼(No.) : CE/2015/20344

日期(Date) : 2015/02/16

頁數(Page): 25 of 65



南亞塑膠工業股份有限公司(台灣) / NAN YA PLASTICS CORPORATION (TAIWAN)

(南亞電子材料(昆山)有限公司 / NAN YA ELECTRONIC MATERIALS (KUNSHAN) CORP., LTD)

(南亞電子材料(惠州)有限公司 / NAN YA ELECTRONIC MATERIALS (HUIZHOU) CORP., LTD)

台灣台北市敦化北路201號 / 201 TUNG HWA NORTH ROAD, TAIPEI, TAIWAN

(江蘇省昆山市長江南路201號 / 201 CHANG JIANG ROAD(S) KUNSHAN ECONOMIC & TECHNICAL DEVELOPMENT ZONE, JIANG SU)

(廣東省惠州市博羅縣石灣鎮永石大道 / YONGSHI BOULEVARD SHIWAN TOWN BOLUO COUNTY HUIZHOU CITY GUANG DONG)

測試項目 (Test Items)	單位 (Unit)	測試方法 (Method)	方法偵測 極限值 (MDL)	結果 (Result)	限值 (Limit)
				No.1	
氟氯氫碳化物 (HCFC)-226 (CAS No.: 431-87-8)	mg/kg	參考US EPA 5021方法, 以氣相層析/質譜儀檢測. / With reference to US EPA 5021 method. Analysis was performed by GC/MS.	1	n.d.	-
氟氯氫碳化物 (HCFC)-231 (CAS No.: 421-94-3)	mg/kg	參考US EPA 5021方法, 以氣相層析/質譜儀檢測. / With reference to US EPA 5021 method. Analysis was performed by GC/MS.	1	n.d.	-
氟氯氫碳化物 (HCFC)-232 (CAS No.: 460-89-9)	mg/kg	參考US EPA 5021方法, 以氣相層析/質譜儀檢測. / With reference to US EPA 5021 method. Analysis was performed by GC/MS.	1	n.d.	-
氟氯氫碳化物 (HCFC)-233 (CAS No.: 7125-84-0)	mg/kg	參考US EPA 5021方法, 以氣相層析/質譜儀檢測. / With reference to US EPA 5021 method. Analysis was performed by GC/MS.	1	n.d.	-
氟氯氫碳化物 (HCFC)-234 (CAS No.: 425-94-5)	mg/kg	參考US EPA 5021方法, 以氣相層析/質譜儀檢測. / With reference to US EPA 5021 method. Analysis was performed by GC/MS.	1	n.d.	-
氟氯氫碳化物 (HCFC)-235 (CAS No.: 460-92-4)	mg/kg	參考US EPA 5021方法, 以氣相層析/質譜儀檢測. / With reference to US EPA 5021 method. Analysis was performed by GC/MS.	1	n.d.	-
氟氯氫碳化物 (HCFC)-241 (CAS No.: 666-27-3)	mg/kg	參考US EPA 5021方法, 以氣相層析/質譜儀檢測. / With reference to US EPA 5021 method. Analysis was performed by GC/MS.	1	n.d.	-

This document is issued by the Company subject to its General Conditions of Service printed overleaf, available on request or accessible at <http://www.sgs.com/en/Terms-and-Conditions.aspx> and, for electronic format documents, subject to Terms and Conditions for Electronic Documents at <http://www.sgs.com/en/Terms-and-Conditions/Termse-Document.aspx>. Attention is drawn to the limitation of liability, indemnification and jurisdiction issues defined therein. Any holder of this document is advised that information contained hereon reflects the Company's findings at the time of its intervention only and within the limits of client's instruction, if any. The Company's sole responsibility is to its Client and this document does not exonerate parties to a transaction from exercising all their rights and obligations under the transaction documents. This document cannot be reproduced, except in full, without prior written approval of the Company. Any unauthorized alteration, forgery or falsification of the content or appearance of this document is unlawful and offenders may be prosecuted to the fullest extent of the law. Unless otherwise stated the results shown in this test report refer only to the sample(s) tested.

# 測試報告

# Test Report

號碼(No.) : CE/2015/20344

日期(Date) : 2015/02/16

頁數(Page): 26 of 65



南亞塑膠工業股份有限公司(台灣) / NAN YA PLASTICS CORPORATION (TAIWAN)

(南亞電子材料(昆山)有限公司 / NAN YA ELECTRONIC MATERIALS (KUNSHAN) CORP., LTD)

(南亞電子材料(惠州)有限公司 / NAN YA ELECTRONIC MATERIALS (HUIZHOU) CORP., LTD)

台灣台北市敦化北路201號 / 201 TUNG HWA NORTH ROAD, TAIPEI, TAIWAN

(江蘇省昆山市長江南路201號 / 201 CHANG JIANG ROAD(S) KUNSHAN ECONOMIC & TECHNICAL DEVELOPMENT ZONE, JIANG SU)

(廣東省惠州市博羅縣石灣鎮永石大道 / YONGSHI BOULEVARD SHIWAN TOWN BOLUO COUNTY HUIZHOU CITY GUANG DONG)

測試項目 (Test Items)	單位 (Unit)	測試方法 (Method)	方法偵測 極限值 (MDL)	結果 (Result)	限值 (Limit)
				No.1	
氟氯氫碳化物 (HCFC)-242 (CAS No.: 460-63-9)	mg/kg	參考US EPA 5021方法, 以氣相層析/質譜儀檢測. / With reference to US EPA 5021 method. Analysis was performed by GC/MS.	1	n.d.	-
氟氯氫碳化物 (HCFC)-243 (CAS No.: 460-69-5)	mg/kg	參考US EPA 5021方法, 以氣相層析/質譜儀檢測. / With reference to US EPA 5021 method. Analysis was performed by GC/MS.	1	n.d.	-
氟氯氫碳化物 (HCFC)-244	mg/kg	參考US EPA 5021方法, 以氣相層析/質譜儀檢測. / With reference to US EPA 5021 method. Analysis was performed by GC/MS.	1	n.d.	-
氟氯氫碳化物 (HCFC)-251 (CAS No.: 421-41-0)	mg/kg	參考US EPA 5021方法, 以氣相層析/質譜儀檢測. / With reference to US EPA 5021 method. Analysis was performed by GC/MS.	1	n.d.	-
氟氯氫碳化物 (HCFC)-252 (CAS No.: 819-00-1)	mg/kg	參考US EPA 5021方法, 以氣相層析/質譜儀檢測. / With reference to US EPA 5021 method. Analysis was performed by GC/MS.	1	n.d.	-
氟氯氫碳化物 (HCFC)-253 (CAS No.: 460-35-5)	mg/kg	參考US EPA 5021方法, 以氣相層析/質譜儀檢測. / With reference to US EPA 5021 method. Analysis was performed by GC/MS.	1	n.d.	-
氟氯氫碳化物 (HCFC)-261 (CAS No.: 420-97-3)	mg/kg	參考US EPA 5021方法, 以氣相層析/質譜儀檢測. / With reference to US EPA 5021 method. Analysis was performed by GC/MS.	1	n.d.	-

This document is issued by the Company subject to its General Conditions of Service printed overleaf, available on request or accessible at <http://www.sgs.com/en/Terms-and-Conditions.aspx> and, for electronic format documents, subject to Terms and Conditions for Electronic Documents at <http://www.sgs.com/en/Terms-and-Conditions/Termse-Document.aspx>. Attention is drawn to the limitation of liability, indemnification and jurisdiction issues defined therein. Any holder of this document is advised that information contained hereon reflects the Company's findings at the time of its intervention only and within the limits of client's instruction, if any. The Company's sole responsibility is to its Client and this document does not exonerate parties to a transaction from exercising all their rights and obligations under the transaction documents. This document cannot be reproduced, except in full, without prior written approval of the Company. Any unauthorized alteration, forgery or falsification of the content or appearance of this document is unlawful and offenders may be prosecuted to the fullest extent of the law. Unless otherwise stated the results shown in this test report refer only to the sample(s) tested.

## 測試報告

## Test Report

號碼(No.) : CE/2015/20344

日期(Date) : 2015/02/16

頁數(Page): 27 of 65



南亞塑膠工業股份有限公司(台灣) / NAN YA PLASTICS CORPORATION (TAIWAN)

(南亞電子材料(昆山)有限公司 / NAN YA ELECTRONIC MATERIALS (KUNSHAN) CORP., LTD)

(南亞電子材料(惠州)有限公司 / NAN YA ELECTRONIC MATERIALS (HUIZHOU) CORP., LTD)

台灣台北市敦化北路201號 / 201 TUNG HWA NORTH ROAD, TAIPEI, TAIWAN

(江蘇省昆山市長江南路201號 / 201 CHANG JIANG ROAD(S) KUNSHAN ECONOMIC & TECHNICAL DEVELOPMENT ZONE, JIANG SU)

(廣東省惠州市博羅縣石灣鎮永石大道 / YONGSHI BOULEVARD SHIWAN TOWN BOLUO COUNTY HUIZHOU CITY GUANG DONG)

測試項目 (Test Items)	單位 (Unit)	測試方法 (Method)	方法偵測 極限值 (MDL)	結果 (Result)	限值 (Limit)
				No.1	
氟氯氫碳化物 (HCFC)-262 (CAS No.: 421-02-03)	mg/kg	參考US EPA 5021方法, 以氣相層析/質譜儀檢測. / With reference to US EPA 5021 method. Analysis was performed by GC/MS.	1	n.d.	-
氟氯氫碳化物 (HCFC)-271 (CAS No.: 430-55-7)	mg/kg	參考US EPA 5021方法, 以氣相層析/質譜儀檢測. / With reference to US EPA 5021 method. Analysis was performed by GC/MS.	1	n.d.	-
<b>海龍 (Halons)</b>					
海龍 (Halon)-1211 (CAS No.: 353-59-3)	mg/kg	參考US EPA 5021方法, 以氣相層析/質譜儀檢測. / With reference to US EPA 5021 method. Analysis was performed by GC/MS.	1	n.d.	-
海龍 (Halon)-1301 (CAS No.: 75-63-8)	mg/kg	參考US EPA 5021方法, 以氣相層析/質譜儀檢測. / With reference to US EPA 5021 method. Analysis was performed by GC/MS.	1	n.d.	-
海龍 (Halon)-2402 (CAS No.: 124-73-2)	mg/kg	參考US EPA 5021方法, 以氣相層析/質譜儀檢測. / With reference to US EPA 5021 method. Analysis was performed by GC/MS.	1	n.d.	-

This document is issued by the Company subject to its General Conditions of Service printed overleaf, available on request or accessible at <http://www.sgs.com/en/Terms-and-Conditions.aspx> and, for electronic format documents, subject to Terms and Conditions for Electronic Documents at <http://www.sgs.com/en/Terms-and-Conditions/Termse-Documents.aspx>. Attention is drawn to the limitation of liability, indemnification and jurisdiction issues defined therein. Any holder of this document is advised that information contained hereon reflects the Company's findings at the time of its intervention only and within the limits of client's instruction, if any. The Company's sole responsibility is to its Client and this document does not exonerate parties to a transaction from exercising all their rights and obligations under the transaction documents. This document cannot be reproduced, except in full, without prior written approval of the Company. Any unauthorized alteration, forgery or falsification of the content or appearance of this document is unlawful and offenders may be prosecuted to the fullest extent of the law. Unless otherwise stated the results shown in this test report refer only to the sample(s) tested.

# 測試報告

# Test Report

號碼(No.) : CE/2015/20344

日期(Date) : 2015/02/16

頁數(Page): 28 of 65



南亞塑膠工業股份有限公司(台灣) / NAN YA PLASTICS CORPORATION (TAIWAN)

(南亞電子材料(昆山)有限公司 / NAN YA ELECTRONIC MATERIALS (KUNSHAN) CORP., LTD)

(南亞電子材料(惠州)有限公司 / NAN YA ELECTRONIC MATERIALS (HUIZHOU) CORP., LTD)

台灣台北市敦化北路201號 / 201 TUNG HWA NORTH ROAD, TAIPEI, TAIWAN

(江蘇省昆山市市長江南路201號 / 201 CHANG JIANG ROAD(S) KUNSHAN ECONOMIC & TECHNICAL DEVELOPMENT ZONE, JIANG SU)

(廣東省惠州市博羅縣石灣鎮永石大道 / YONGSHI BOULEVARD SHIWAN TOWN BOLUO COUNTY HUIZHOU CITY GUANG DONG)

測試項目 (Test Items)	單位 (Unit)	測試方法 (Method)	方法偵測 極限值 (MDL)	結果 (Result)	限值 (Limit)
				No.1	
不完全鹵化氟溴化物 / HBFCs (Hydrobromofluorocarbons)					
不完全鹵化氟溴化物 (HBFC)-21B2 (CH <sub>2</sub> FBr <sub>2</sub> ) (CAS No.: 1868-53-7)	mg/kg	參考US EPA 5021方法, 以氣相層析/質譜儀檢測. / With reference to US EPA 5021 method. Analysis was performed by GC/MS.	1	n.d.	-
不完全鹵化氟溴化物 (HBFC)-22B1 (CH <sub>2</sub> F <sub>2</sub> Br) (CAS No.: 1511-62-2)	mg/kg	參考US EPA 5021方法, 以氣相層析/質譜儀檢測. / With reference to US EPA 5021 method. Analysis was performed by GC/MS.	1	n.d.	-
不完全鹵化氟溴化物 (HBFC)-31B1 (CH <sub>2</sub> FBr) (CAS No.: 373-52-4)	mg/kg	參考US EPA 5021方法, 以氣相層析/質譜儀檢測. / With reference to US EPA 5021 method. Analysis was performed by GC/MS.	1	n.d.	-
不完全鹵化氟溴化物 (HBFC)-121B4 (C <sub>2</sub> H <sub>2</sub> FBr <sub>4</sub> )	mg/kg	參考US EPA 5021方法, 以氣相層析/質譜儀檢測. / With reference to US EPA 5021 method. Analysis was performed by GC/MS.	1	n.d.	-
不完全鹵化氟溴化物 (HBFC)-122B3 (C <sub>2</sub> H <sub>2</sub> F <sub>2</sub> Br <sub>3</sub> )	mg/kg	參考US EPA 5021方法, 以氣相層析/質譜儀檢測. / With reference to US EPA 5021 method. Analysis was performed by GC/MS.	1	n.d.	-
不完全鹵化氟溴化物 (HBFC)-123B2 (C <sub>2</sub> H <sub>2</sub> F <sub>3</sub> Br <sub>2</sub> )	mg/kg	參考US EPA 5021方法, 以氣相層析/質譜儀檢測. / With reference to US EPA 5021 method. Analysis was performed by GC/MS.	1	n.d.	-

This document is issued by the Company subject to its General Conditions of Service printed overleaf, available on request or accessible at <http://www.sgs.com/en/Terms-and-Conditions.aspx> and, for electronic format documents, subject to Terms and Conditions for Electronic Documents at <http://www.sgs.com/en/Terms-and-Conditions/Termse-Documents.aspx>. Attention is drawn to the limitation of liability, indemnification and jurisdiction issues defined therein. Any holder of this document is advised that information contained hereon reflects the Company's findings at the time of its intervention only and within the limits of client's instruction, if any. The Company's sole responsibility is to its Client and this document does not exonerate parties to a transaction from exercising all their rights and obligations under the transaction documents. This document cannot be reproduced, except in full, without prior written approval of the Company. Any unauthorized alteration, forgery or falsification of the content or appearance of this document is unlawful and offenders may be prosecuted to the fullest extent of the law. Unless otherwise stated the results shown in this test report refer only to the sample(s) tested.



# 測試報告

# Test Report

號碼(No.) : CE/2015/20344

日期(Date) : 2015/02/16

頁數(Page): 29 of 65



南亞塑膠工業股份有限公司(台灣) / NAN YA PLASTICS CORPORATION (TAIWAN)

(南亞電子材料(昆山)有限公司 / NAN YA ELECTRONIC MATERIALS (KUNSHAN) CORP., LTD)

(南亞電子材料(惠州)有限公司 / NAN YA ELECTRONIC MATERIALS (HUIZHOU) CORP., LTD)

台灣台北市敦化北路201號 / 201 TUNG HWA NORTH ROAD, TAIPEI, TAIWAN

(江蘇省昆山市長江南路201號 / 201 CHANG JIANG ROAD(S) KUNSHAN ECONOMIC & TECHNICAL DEVELOPMENT ZONE, JIANG SU)

(廣東省惠州市博羅縣石灣鎮永石大道 / YONGSHI BOULEVARD SHIWAN TOWN BOLUO COUNTY HUIZHOU CITY GUANG DONG)

測試項目 (Test Items)	單位 (Unit)	測試方法 (Method)	方法偵測 極限值 (MDL)	結果 (Result)	限值 (Limit)
				No.1	
不完全鹵化氟溴化物 (HBFC)-124B1 (C2HF4Br)	mg/kg	參考US EPA 5021方法, 以氣相層析/質譜儀檢測. / With reference to US EPA 5021 method. Analysis was performed by GC/MS.	1	n.d.	-
不完全鹵化氟溴化物 (HBFC)-131B3 (C2H2FBr3)	mg/kg	參考US EPA 5021方法, 以氣相層析/質譜儀檢測. / With reference to US EPA 5021 method. Analysis was performed by GC/MS.	1	n.d.	-
不完全鹵化氟溴化物 (HBFC)-132B2 (C2H2F2Br2)	mg/kg	參考US EPA 5021方法, 以氣相層析/質譜儀檢測. / With reference to US EPA 5021 method. Analysis was performed by GC/MS.	1	n.d.	-
不完全鹵化氟溴化物 (HBFC)-133B1 (C2H2F3Br)	mg/kg	參考US EPA 5021方法, 以氣相層析/質譜儀檢測. / With reference to US EPA 5021 method. Analysis was performed by GC/MS.	1	n.d.	-
不完全鹵化氟溴化物 (HBFC)-141B2 (C2H3FBr2)	mg/kg	參考US EPA 5021方法, 以氣相層析/質譜儀檢測. / With reference to US EPA 5021 method. Analysis was performed by GC/MS.	1	n.d.	-
不完全鹵化氟溴化物 (HBFC)-142B1 (C2H3F2Br)	mg/kg	參考US EPA 5021方法, 以氣相層析/質譜儀檢測. / With reference to US EPA 5021 method. Analysis was performed by GC/MS.	1	n.d.	-
不完全鹵化氟溴化物 (HBFC)-151B1 (C2H4FBr)	mg/kg	參考US EPA 5021方法, 以氣相層析/質譜儀檢測. / With reference to US EPA 5021 method. Analysis was performed by GC/MS.	1	n.d.	-

This document is issued by the Company subject to its General Conditions of Service printed overleaf, available on request or accessible at <http://www.sgs.com/en/Terms-and-Conditions.aspx> and, for electronic format documents, subject to Terms and Conditions for Electronic Documents at <http://www.sgs.com/en/Terms-and-Conditions/Termse-Documents.aspx>. Attention is drawn to the limitation of liability, indemnification and jurisdiction issues defined therein. Any holder of this document is advised that information contained hereon reflects the Company's findings at the time of its intervention only and within the limits of client's instruction, if any. The Company's sole responsibility is to its Client and this document does not exonerate parties to a transaction from exercising all their rights and obligations under the transaction documents. This document cannot be reproduced, except in full, without prior written approval of the Company. Any unauthorized alteration, forgery or falsification of the content or appearance of this document is unlawful and offenders may be prosecuted to the fullest extent of the law. Unless otherwise stated the results shown in this test report refer only to the sample(s) tested.

## 測試報告

號碼(No.) : CE/2015/20344

日期(Date) : 2015/02/16

頁數(Page): 30 of 65

## Test Report



南亞塑膠工業股份有限公司(台灣) / NAN YA PLASTICS CORPORATION (TAIWAN)

(南亞電子材料(昆山)有限公司 / NAN YA ELECTRONIC MATERIALS (KUNSHAN) CORP., LTD)

(南亞電子材料(惠州)有限公司 / NAN YA ELECTRONIC MATERIALS (HUIZHOU) CORP., LTD)

台灣台北市敦化北路201號 / 201 TUNG HWA NORTH ROAD, TAIPEI, TAIWAN

(江蘇省昆山市長江南路201號 / 201 CHANG JIANG ROAD(S) KUNSHAN ECONOMIC & TECHNICAL DEVELOPMENT ZONE, JIANG SU)

(廣東省惠州市博羅縣石灣鎮永石大道 / YONGSHI BOULEVARD SHIWAN TOWN BOLUO COUNTY HUIZHOU CITY GUANG DONG)

測試項目 (Test Items)	單位 (Unit)	測試方法 (Method)	方法偵測 極限值 (MDL)	結果 (Result)	限值 (Limit)
				No.1	
不完全鹵化氟溴化物 (HBFC)-221B6 (C3HFBr6)	mg/kg	參考US EPA 5021方法, 以氣相層析/質譜儀檢測. / With reference to US EPA 5021 method. Analysis was performed by GC/MS.	1	n.d.	-
不完全鹵化氟溴化物 (HBFC)-222B5 (C3HF2Br5)	mg/kg	參考US EPA 5021方法, 以氣相層析/質譜儀檢測. / With reference to US EPA 5021 method. Analysis was performed by GC/MS.	1	n.d.	-
不完全鹵化氟溴化物 (HBFC)-223B4 (C3HF3Br4)	mg/kg	參考US EPA 5021方法, 以氣相層析/質譜儀檢測. / With reference to US EPA 5021 method. Analysis was performed by GC/MS.	1	n.d.	-
不完全鹵化氟溴化物 (HBFC)-224B3 (C3HF4Br3)	mg/kg	參考US EPA 5021方法, 以氣相層析/質譜儀檢測. / With reference to US EPA 5021 method. Analysis was performed by GC/MS.	1	n.d.	-
不完全鹵化氟溴化物 (HBFC)-225B2 (C3HF5Br2)	mg/kg	參考US EPA 5021方法, 以氣相層析/質譜儀檢測. / With reference to US EPA 5021 method. Analysis was performed by GC/MS.	1	n.d.	-
不完全鹵化氟溴化物 (HBFC)-226B1 (C3HF6Br)	mg/kg	參考US EPA 5021方法, 以氣相層析/質譜儀檢測. / With reference to US EPA 5021 method. Analysis was performed by GC/MS.	1	n.d.	-
不完全鹵化氟溴化物 (HBFC)-231B5 (C3H2FBr5)	mg/kg	參考US EPA 5021方法, 以氣相層析/質譜儀檢測. / With reference to US EPA 5021 method. Analysis was performed by GC/MS.	1	n.d.	-

This document is issued by the Company subject to its General Conditions of Service printed overleaf, available on request or accessible at <http://www.sgs.com/en/Terms-and-Conditions.aspx> and, for electronic format documents, subject to Terms and Conditions for Electronic Documents at <http://www.sgs.com/en/Terms-and-Conditions/Termse-Document.aspx>. Attention is drawn to the limitation of liability, indemnification and jurisdiction issues defined therein. Any holder of this document is advised that information contained hereon reflects the Company's findings at the time of its intervention only and within the limits of client's instruction, if any. The Company's sole responsibility is to its Client and this document does not exonerate parties to a transaction from exercising all their rights and obligations under the transaction documents. This document cannot be reproduced, except in full, without prior written approval of the Company. Any unauthorized alteration, forgery or falsification of the content or appearance of this document is unlawful and offenders may be prosecuted to the fullest extent of the law. Unless otherwise stated the results shown in this test report refer only to the sample(s) tested.

## 測試報告

號碼(No.) : CE/2015/20344

日期(Date) : 2015/02/16

頁數(Page): 31 of 65

## Test Report



南亞塑膠工業股份有限公司(台灣) / NAN YA PLASTICS CORPORATION (TAIWAN)

(南亞電子材料(昆山)有限公司 / NAN YA ELECTRONIC MATERIALS (KUNSHAN) CORP., LTD)

(南亞電子材料(惠州)有限公司 / NAN YA ELECTRONIC MATERIALS (HUIZHOU) CORP., LTD)

台灣台北市敦化北路201號 / 201 TUNG HWA NORTH ROAD, TAIPEI, TAIWAN

(江蘇省昆山市長江南路201號 / 201 CHANG JIANG ROAD(S) KUNSHAN ECONOMIC & TECHNICAL DEVELOPMENT ZONE, JIANG SU)

(廣東省惠州市博羅縣石灣鎮永石大道 / YONGSHI BOULEVARD SHIWAN TOWN BOLUO COUNTY HUIZHOU CITY GUANG DONG)

測試項目 (Test Items)	單位 (Unit)	測試方法 (Method)	方法偵測 極限值 (MDL)	結果 (Result)	限值 (Limit)
				No.1	
不完全鹵化氟溴化物 (HBFC)-232B4 (C3H2F2Br4)	mg/kg	參考US EPA 5021方法, 以氣相層析/質譜儀檢測. / With reference to US EPA 5021 method. Analysis was performed by GC/MS.	1	n.d.	-
不完全鹵化氟溴化物 (HBFC)-233B3 (C3H2F3Br3)	mg/kg	參考US EPA 5021方法, 以氣相層析/質譜儀檢測. / With reference to US EPA 5021 method. Analysis was performed by GC/MS.	1	n.d.	-
不完全鹵化氟溴化物 (HBFC)-234B2 (C3H2F4Br2)	mg/kg	參考US EPA 5021方法, 以氣相層析/質譜儀檢測. / With reference to US EPA 5021 method. Analysis was performed by GC/MS.	1	n.d.	-
不完全鹵化氟溴化物 (HBFC)-235B1 (C3H2F5Br)	mg/kg	參考US EPA 5021方法, 以氣相層析/質譜儀檢測. / With reference to US EPA 5021 method. Analysis was performed by GC/MS.	1	n.d.	-
不完全鹵化氟溴化物 (HBFC)-241B4 (C3H3FBr4)	mg/kg	參考US EPA 5021方法, 以氣相層析/質譜儀檢測. / With reference to US EPA 5021 method. Analysis was performed by GC/MS.	1	n.d.	-
不完全鹵化氟溴化物 (HBFC)-242B3 (C3H3F2Br3)	mg/kg	參考US EPA 5021方法, 以氣相層析/質譜儀檢測. / With reference to US EPA 5021 method. Analysis was performed by GC/MS.	1	n.d.	-
不完全鹵化氟溴化物 (HBFC)-243B2 (C3H3F3Br2)	mg/kg	參考US EPA 5021方法, 以氣相層析/質譜儀檢測. / With reference to US EPA 5021 method. Analysis was performed by GC/MS.	1	n.d.	-

This document is issued by the Company subject to its General Conditions of Service printed overleaf, available on request or accessible at <http://www.sgs.com/en/Terms-and-Conditions.aspx> and, for electronic format documents, subject to Terms and Conditions for Electronic Documents at <http://www.sgs.com/en/Terms-and-Conditions/Termse-Documents.aspx>. Attention is drawn to the limitation of liability, indemnification and jurisdiction issues defined therein. Any holder of this document is advised that information contained hereon reflects the Company's findings at the time of its intervention only and within the limits of client's instruction, if any. The Company's sole responsibility is to its Client and this document does not exonerate parties to a transaction from exercising all their rights and obligations under the transaction documents. This document cannot be reproduced, except in full, without prior written approval of the Company. Any unauthorized alteration, forgery or falsification of the content or appearance of this document is unlawful and offenders may be prosecuted to the fullest extent of the law. Unless otherwise stated the results shown in this test report refer only to the sample(s) tested.

# 測試報告

# Test Report

號碼(No.) : CE/2015/20344

日期(Date) : 2015/02/16

頁數(Page): 32 of 65



南亞塑膠工業股份有限公司(台灣) / NAN YA PLASTICS CORPORATION (TAIWAN)

(南亞電子材料(昆山)有限公司 / NAN YA ELECTRONIC MATERIALS (KUNSHAN) CORP., LTD)

(南亞電子材料(惠州)有限公司 / NAN YA ELECTRONIC MATERIALS (HUIZHOU) CORP., LTD)

台灣台北市敦化北路201號 / 201 TUNG HWA NORTH ROAD, TAIPEI, TAIWAN

(江蘇省昆山市長江南路201號 / 201 CHANG JIANG ROAD(S) KUNSHAN ECONOMIC & TECHNICAL DEVELOPMENT ZONE, JIANG SU)

(廣東省惠州市博羅縣石灣鎮永石大道 / YONGSHI BOULEVARD SHIWAN TOWN BOLUO COUNTY HUIZHOU CITY GUANG DONG)

測試項目 (Test Items)	單位 (Unit)	測試方法 (Method)	方法偵測 極限值 (MDL)	結果 (Result)	限值 (Limit)
				No.1	
不完全鹵化氟溴化物 (HBFC)-244B1 (C3H3F4Br)	mg/kg	參考US EPA 5021方法, 以氣相層析/質譜儀檢測. / With reference to US EPA 5021 method. Analysis was performed by GC/MS.	1	n.d.	-
不完全鹵化氟溴化物 (HBFC)-251B3 (C3H4FBr3)	mg/kg	參考US EPA 5021方法, 以氣相層析/質譜儀檢測. / With reference to US EPA 5021 method. Analysis was performed by GC/MS.	1	n.d.	-
不完全鹵化氟溴化物 (HBFC)-252B2 (C3H4F2Br2)	mg/kg	參考US EPA 5021方法, 以氣相層析/質譜儀檢測. / With reference to US EPA 5021 method. Analysis was performed by GC/MS.	1	n.d.	-
不完全鹵化氟溴化物 (HBFC)-253B1 (C3H4F3Br)	mg/kg	參考US EPA 5021方法, 以氣相層析/質譜儀檢測. / With reference to US EPA 5021 method. Analysis was performed by GC/MS.	1	n.d.	-
不完全鹵化氟溴化物 (HBFC)-261B2 (C3H5FBr2)	mg/kg	參考US EPA 5021方法, 以氣相層析/質譜儀檢測. / With reference to US EPA 5021 method. Analysis was performed by GC/MS.	1	n.d.	-
不完全鹵化氟溴化物 (HBFC)-262B1 (C3H5F2Br)	mg/kg	參考US EPA 5021方法, 以氣相層析/質譜儀檢測. / With reference to US EPA 5021 method. Analysis was performed by GC/MS.	1	n.d.	-
不完全鹵化氟溴化物 (HBFC)-271B1 (C3H6FBr)	mg/kg	參考US EPA 5021方法, 以氣相層析/質譜儀檢測. / With reference to US EPA 5021 method. Analysis was performed by GC/MS.	1	n.d.	-

This document is issued by the Company subject to its General Conditions of Service printed overleaf, available on request or accessible at <http://www.sgs.com/en/Terms-and-Conditions.aspx> and, for electronic format documents, subject to Terms and Conditions for Electronic Documents at <http://www.sgs.com/en/Terms-and-Conditions/Termse-Documents.aspx>. Attention is drawn to the limitation of liability, indemnification and jurisdiction issues defined therein. Any holder of this document is advised that information contained hereon reflects the Company's findings at the time of its intervention only and within the limits of client's instruction, if any. The Company's sole responsibility is to its Client and this document does not exonerate parties to a transaction from exercising all their rights and obligations under the transaction documents. This document cannot be reproduced, except in full, without prior written approval of the Company. Any unauthorized alteration, forgery or falsification of the content or appearance of this document is unlawful and offenders may be prosecuted to the fullest extent of the law. Unless otherwise stated the results shown in this test report refer only to the sample(s) tested.

# 測試報告

# Test Report

號碼(No.) : CE/2015/20344

日期(Date) : 2015/02/16

頁數(Page): 33 of 65



南亞塑膠工業股份有限公司(台灣) / NAN YA PLASTICS CORPORATION (TAIWAN)

(南亞電子材料(昆山)有限公司 / NAN YA ELECTRONIC MATERIALS (KUNSHAN) CORP., LTD)

(南亞電子材料(惠州)有限公司 / NAN YA ELECTRONIC MATERIALS (HUIZHOU) CORP., LTD)

台灣台北市敦化北路201號 / 201 TUNG HWA NORTH ROAD, TAIPEI, TAIWAN

(江蘇省昆山市市長江南路201號 / 201 CHANG JIANG ROAD(S) KUNSHAN ECONOMIC & TECHNICAL DEVELOPMENT ZONE, JIANG SU)

(廣東省惠州市博羅縣石灣鎮永石大道 / YONGSHI BOULEVARD SHIWAN TOWN BOLUO COUNTY HUIZHOU CITY GUANG DONG)

測試項目 (Test Items)	單位 (Unit)	測試方法 (Method)	方法偵測 極限值 (MDL)	結果 (Result)	限值 (Limit)
				No.1	
氯化碳氫化合物 / CHCs (Chlorinate hydrocarbon)					
1,1,1,2-四氯乙烷 / 1,1,1,2-Tetrachloroethane (CAS No.: 630-20-6)	mg/kg	參考US EPA 5021方法, 以氣相層析/質譜儀檢測. / With reference to US EPA 5021 method. Analysis was performed by GC/MS.	1	n.d.	-
1,1,1-三氯乙烷 / 1,1,1-Trichloroethane (CAS No.: 71-55-6)	mg/kg	參考US EPA 5021方法, 以氣相層析/質譜儀檢測. / With reference to US EPA 5021 method. Analysis was performed by GC/MS.	1	n.d.	-
1,1,2,2-四氯乙烷 / 1,1,2,2-Tetrachloroethane (CAS No.: 79-34-5)	mg/kg	參考US EPA 5021方法, 以氣相層析/質譜儀檢測. / With reference to US EPA 5021 method. Analysis was performed by GC/MS.	1	n.d.	-
1,1,2-三氯乙烷 / 1,1,2-Trichloroethane (CAS No.: 79-00-5)	mg/kg	參考US EPA 5021方法, 以氣相層析/質譜儀檢測. / With reference to US EPA 5021 method. Analysis was performed by GC/MS.	1	n.d.	-
1,1-二氯乙烷 / 1,1-Dichloroethane (CAS No.: 75-34-3)	mg/kg	參考US EPA 5021方法, 以氣相層析/質譜儀檢測. / With reference to US EPA 5021 method. Analysis was performed by GC/MS.	1	n.d.	-
1,1-二氯乙烯 / 1,1-Dichloroethene (CAS No.: 75-35-4)	mg/kg	參考US EPA 5021方法, 以氣相層析/質譜儀檢測. / With reference to US EPA 5021 method. Analysis was performed by GC/MS.	1	n.d.	-

This document is issued by the Company subject to its General Conditions of Service printed overleaf, available on request or accessible at <http://www.sgs.com/en/Terms-and-Conditions.aspx> and, for electronic format documents, subject to Terms and Conditions for Electronic Documents at <http://www.sgs.com/en/Terms-and-Conditions/Termse-Documents.aspx>. Attention is drawn to the limitation of liability, indemnification and jurisdiction issues defined therein. Any holder of this document is advised that information contained hereon reflects the Company's findings at the time of its intervention only and within the limits of client's instruction, if any. The Company's sole responsibility is to its Client and this document does not exonerate parties to a transaction from exercising all their rights and obligations under the transaction documents. This document cannot be reproduced, except in full, without prior written approval of the Company. Any unauthorized alteration, forgery or falsification of the content or appearance of this document is unlawful and offenders may be prosecuted to the fullest extent of the law. Unless otherwise stated the results shown in this test report refer only to the sample(s) tested.

# 測試報告

# Test Report

號碼(No.) : CE/2015/20344

日期(Date) : 2015/02/16

頁數(Page): 34 of 65



南亞塑膠工業股份有限公司(台灣) / NAN YA PLASTICS CORPORATION (TAIWAN)

(南亞電子材料(昆山)有限公司 / NAN YA ELECTRONIC MATERIALS (KUNSHAN) CORP., LTD)

(南亞電子材料(惠州)有限公司 / NAN YA ELECTRONIC MATERIALS (HUIZHOU) CORP., LTD)

台灣台北市敦化北路201號 / 201 TUNG HWA NORTH ROAD, TAIPEI, TAIWAN

(江蘇省昆山市長江南路201號 / 201 CHANG JIANG ROAD(S) KUNSHAN ECONOMIC & TECHNICAL DEVELOPMENT ZONE, JIANG SU)

(廣東省惠州市博羅縣石灣鎮永石大道 / YONGSHI BOULEVARD SHIWAN TOWN BOLUO COUNTY HUIZHOU CITY GUANG DONG)

測試項目 (Test Items)	單位 (Unit)	測試方法 (Method)	方法偵測 極限值 (MDL)	結果 (Result)	限值 (Limit)
				No.1	
1,1-二氯丙烯 / 1,1-Dichloropropene (CAS No.: 563-58-6)	mg/kg	參考US EPA 5021方法, 以氣相層析/質譜儀檢測. / With reference to US EPA 5021 method. Analysis was performed by GC/MS.	1	n.d.	-
1,2,3-三氯丙烷 / 1,2,3-Trichloropropane (CAS No.: 96-18-4)	mg/kg	參考US EPA 5021方法, 以氣相層析/質譜儀檢測. / With reference to US EPA 5021 method. Analysis was performed by GC/MS.	1	n.d.	-
1,2-二氯乙烷 / 1,2-Dichloroethane (CAS No.: 107-06-2)	mg/kg	參考US EPA 5021方法, 以氣相層析/質譜儀檢測. / With reference to US EPA 5021 method. Analysis was performed by GC/MS.	1	n.d.	-
1,2-二氯丙烷 / 1,2-Dichloropropane (CAS No.: 78-87-5)	mg/kg	參考US EPA 5021方法, 以氣相層析/質譜儀檢測. / With reference to US EPA 5021 method. Analysis was performed by GC/MS.	1	n.d.	-
1,3-二氯丙烷 / 1,3-Dichloropropane (CAS No.: 142-28-9)	mg/kg	參考US EPA 5021方法, 以氣相層析/質譜儀檢測. / With reference to US EPA 5021 method. Analysis was performed by GC/MS.	1	n.d.	-
2,2-二氯丙烷 / 2,2-Dichloropropane (CAS No.: 594-20-7)	mg/kg	參考US EPA 5021方法, 以氣相層析/質譜儀檢測. / With reference to US EPA 5021 method. Analysis was performed by GC/MS.	1	n.d.	-
四氯甲烷 (四氯化碳) / Carbon tetrachloride (CAS No.: 56-23-5)	mg/kg	參考US EPA 5021方法, 以氣相層析/質譜儀檢測. / With reference to US EPA 5021 method. Analysis was performed by GC/MS.	1	n.d.	-

This document is issued by the Company subject to its General Conditions of Service printed overleaf, available on request or accessible at <http://www.sgs.com/en/Terms-and-Conditions.aspx> and, for electronic format documents, subject to Terms and Conditions for Electronic Documents at <http://www.sgs.com/en/Terms-and-Conditions/Termse-Document.aspx>. Attention is drawn to the limitation of liability, indemnification and jurisdiction issues defined therein. Any holder of this document is advised that information contained hereon reflects the Company's findings at the time of its intervention only and within the limits of client's instruction, if any. The Company's sole responsibility is to its Client and this document does not exonerate parties to a transaction from exercising all their rights and obligations under the transaction documents. This document cannot be reproduced, except in full, without prior written approval of the Company. Any unauthorized alteration, forgery or falsification of the content or appearance of this document is unlawful and offenders may be prosecuted to the fullest extent of the law. Unless otherwise stated the results shown in this test report refer only to the sample(s) tested.



# 測試報告

# Test Report

號碼(No.) : CE/2015/20344

日期(Date) : 2015/02/16

頁數(Page): 35 of 65



南亞塑膠工業股份有限公司(台灣) / NAN YA PLASTICS CORPORATION (TAIWAN)

(南亞電子材料(昆山)有限公司 / NAN YA ELECTRONIC MATERIALS (KUNSHAN) CORP., LTD)

(南亞電子材料(惠州)有限公司 / NAN YA ELECTRONIC MATERIALS (HUIZHOU) CORP., LTD)

台灣台北市敦化北路201號 / 201 TUNG HWA NORTH ROAD, TAIPEI, TAIWAN

(江蘇省昆山市長江南路201號 / 201 CHANG JIANG ROAD(S) KUNSHAN ECONOMIC & TECHNICAL DEVELOPMENT ZONE, JIANG SU)

(廣東省惠州市博羅縣石灣鎮永石大道 / YONGSHI BOULEVARD SHIWAN TOWN BOLUO COUNTY HUIZHOU CITY GUANG DONG)

測試項目 (Test Items)	單位 (Unit)	測試方法 (Method)	方法偵測 極限值 (MDL)	結果 (Result)	限值 (Limit)
				No.1	
氯乙烷 / Chloroethane (CAS No.: 75-00-3)	mg/kg	參考US EPA 5021方法, 以氣相層析/質譜儀檢測. / With reference to US EPA 5021 method. Analysis was performed by GC/MS.	1	n.d.	-
氯仿 / Chloroform (CAS No.: 67-66-3)	mg/kg	參考US EPA 5021方法, 以氣相層析/質譜儀檢測. / With reference to US EPA 5021 method. Analysis was performed by GC/MS.	1	n.d.	-
氯甲烷 / Chloromethane (CAS No.: 74-87-3)	mg/kg	參考US EPA 5021方法, 以氣相層析/質譜儀檢測. / With reference to US EPA 5021 method. Analysis was performed by GC/MS.	1	n.d.	-
順-1,2-二氯乙烯 / cis-1,2-Dichloroethene (CAS No.: 156-59-2)	mg/kg	參考US EPA 5021方法, 以氣相層析/質譜儀檢測. / With reference to US EPA 5021 method. Analysis was performed by GC/MS.	1	n.d.	-
順-1,3-二氯丙烯 / cis-1,3-Dichloropropene (CAS No.: 10061-01-5)	mg/kg	參考US EPA 5021方法, 以氣相層析/質譜儀檢測. / With reference to US EPA 5021 method. Analysis was performed by GC/MS.	1	n.d.	-
六氯丁二烯 / Hexachlorobutadiene (CAS No.: 87-68-3)	mg/kg	參考US EPA 5021方法, 以氣相層析/質譜儀檢測. / With reference to US EPA 5021 method. Analysis was performed by GC/MS.	1	n.d.	-
二氯甲烷 / Dichloromethane (CAS No.: 75-09-2)	mg/kg	參考US EPA 5021方法, 以氣相層析/質譜儀檢測. / With reference to US EPA 5021 method. Analysis was performed by GC/MS.	1	n.d.	-

This document is issued by the Company subject to its General Conditions of Service printed overleaf, available on request or accessible at <http://www.sgs.com/en/Terms-and-Conditions.aspx> and, for electronic format documents, subject to Terms and Conditions for Electronic Documents at <http://www.sgs.com/en/Terms-and-Conditions/Termse-Document.aspx>. Attention is drawn to the limitation of liability, indemnification and jurisdiction issues defined therein. Any holder of this document is advised that information contained hereon reflects the Company's findings at the time of its intervention only and within the limits of client's instruction, if any. The Company's sole responsibility is to its Client and this document does not exonerate parties to a transaction from exercising all their rights and obligations under the transaction documents. This document cannot be reproduced, except in full, without prior written approval of the Company. Any unauthorized alteration, forgery or falsification of the content or appearance of this document is unlawful and offenders may be prosecuted to the fullest extent of the law. Unless otherwise stated the results shown in this test report refer only to the sample(s) tested.

# 測試報告

# Test Report

號碼(No.) : CE/2015/20344

日期(Date) : 2015/02/16

頁數(Page): 36 of 65



南亞塑膠工業股份有限公司(台灣) / NAN YA PLASTICS CORPORATION (TAIWAN)

(南亞電子材料(昆山)有限公司 / NAN YA ELECTRONIC MATERIALS (KUNSHAN) CORP., LTD)

(南亞電子材料(惠州)有限公司 / NAN YA ELECTRONIC MATERIALS (HUIZHOU) CORP., LTD)

台灣台北市敦化北路201號 / 201 TUNG HWA NORTH ROAD, TAIPEI, TAIWAN

(江蘇省昆山市長江南路201號 / 201 CHANG JIANG ROAD(S) KUNSHAN ECONOMIC & TECHNICAL DEVELOPMENT ZONE, JIANG SU)

(廣東省惠州市博羅縣石灣鎮永石大道 / YONGSHI BOULEVARD SHIWAN TOWN BOLUO COUNTY HUIZHOU CITY GUANG DONG)

測試項目 (Test Items)	單位 (Unit)	測試方法 (Method)	方法偵測 極限值 (MDL)	結果 (Result)	限值 (Limit)
				No.1	
四氯乙烯 / Tetrachloroethene (CAS No.: 127-18-4)	mg/kg	參考US EPA 5021方法, 以氣相層析/質譜儀檢測. / With reference to US EPA 5021 method. Analysis was performed by GC/MS.	1	n.d.	-
反-1,2-二氯乙烯 / trans-1,2-Dichloroethene (CAS No.: 156-60-5)	mg/kg	參考US EPA 5021方法, 以氣相層析/質譜儀檢測. / With reference to US EPA 5021 method. Analysis was performed by GC/MS.	1	n.d.	-
反-1,3-二氯丙烯 / trans-1,3-Dichloropropene (CAS No.: 10061-02-6)	mg/kg	參考US EPA 5021方法, 以氣相層析/質譜儀檢測. / With reference to US EPA 5021 method. Analysis was performed by GC/MS.	1	n.d.	-
三氯乙烯 / Trichloroethylene (CAS No.: 79-01-6)	mg/kg	參考US EPA 5021方法, 以氣相層析/質譜儀檢測. / With reference to US EPA 5021 method. Analysis was performed by GC/MS.	1	n.d.	-
<b>石棉 / Asbestos</b>					
陽起石綿 / Actinolite (CAS No.: 77536-66-4)	%	參考EPA 600/R-93/116 / 立體顯微鏡 (SM), 分散染色式偏光顯微鏡 (DS-PLM)及X光繞射光譜分析法 (XRD) / With reference to EPA 600/R-93/116 method. Analysis was performed by Stereo Microscope (SM), Dispersion Staining Polarized Light Microscope (DS-PLM) and X-ray Diffraction Spectrometer (XRD).	-	Negative	-
鐵石綿(褐石綿) / Amosite (CAS No.: 12172-73-5)			-	Negative	-
斜方角閃石綿 / Anthophyllite (CAS No.: 77536-67-5)			-	Negative	-
溫石綿(白石綿) / Chrysotile (CAS No.: 12001-29-5)			-	Negative	-
青石綿 / Crocidolite (CAS No.: 12001-28-4)			-	Negative	-
透閃石綿 / Tremolite (CAS No.: 77536-68-6)			-	Negative	-

This document is issued by the Company subject to its General Conditions of Service printed overleaf, available on request or accessible at <http://www.sgs.com/en/Terms-and-Conditions.aspx> and, for electronic format documents, subject to Terms and Conditions for Electronic Documents at <http://www.sgs.com/en/Terms-and-Conditions/Termse-Documents.aspx>. Attention is drawn to the limitation of liability, indemnification and jurisdiction issues defined therein. Any holder of this document is advised that information contained hereon reflects the Company's findings at the time of its intervention only and within the limits of client's instruction, if any. The Company's sole responsibility is to its Client and this document does not exonerate parties to a transaction from exercising all their rights and obligations under the transaction documents. This document cannot be reproduced, except in full, without prior written approval of the Company. Any unauthorized alteration, forgery or falsification of the content or appearance of this document is unlawful and offenders may be prosecuted to the fullest extent of the law. Unless otherwise stated the results shown in this test report refer only to the sample(s) tested.

# 測試報告

# Test Report

號碼(No.) : CE/2015/20344

日期(Date) : 2015/02/16

頁數(Page): 37 of 65



南亞塑膠工業股份有限公司(台灣) / NAN YA PLASTICS CORPORATION (TAIWAN)

(南亞電子材料(昆山)有限公司 / NAN YA ELECTRONIC MATERIALS (KUNSHAN) CORP., LTD)

(南亞電子材料(惠州)有限公司 / NAN YA ELECTRONIC MATERIALS (HUIZHOU) CORP., LTD)

台灣台北市敦化北路201號 / 201 TUNG HWA NORTH ROAD, TAIPEI, TAIWAN

(江蘇省昆山市長江南路201號 / 201 CHANG JIANG ROAD(S) KUNSHAN ECONOMIC & TECHNICAL DEVELOPMENT ZONE, JIANG SU)

(廣東省惠州市博羅縣石灣鎮永石大道 / YONGSHI BOULEVARD SHIWAN TOWN BOLUO COUNTY HUIZHOU CITY GUANG DONG)

測試項目 (Test Items)	單位 (Unit)	測試方法 (Method)	方法偵測 極限值 (MDL)	結果 (Result)	限值 (Limit)
				No.1	
多環芳香煙 / Polynuclear Aromatic Hydrocarbons (PAHs)					
芘 / Acenaphthene (CAS No.: 83-32-9)	mg/kg	參考ZLS standard ZEK 01.4-08方法, 以氣相層析/質譜儀檢測. / With reference to ZLS standard ZEK 01.4-08 method. Analysis was performed by GC/MS.	0.2	n.d.	-
芴 / Acenaphthylene (CAS No.: 208-96-8)	mg/kg		0.2	n.d.	-
蔥 / Anthracene (CAS No.: 120-12-7)	mg/kg		0.2	n.d.	-
苯駢蔥 / Benzo[a]anthracene (CAS No.: 56-55-3)	mg/kg		0.2	n.d.	-
苯駢(a)芘 / Benzo[a]pyrene (CAS No.: 50-32-8)	mg/kg		0.2	n.d.	-
苯(b)苯駢芴 / Benzo[b]fluoranthene (CAS No.: 205-99-2)	mg/kg		0.2	n.d.	-
苯駢芘 / Benzo[g,h,i]perylene (CAS No.: 191-24-2)	mg/kg		0.2	n.d.	-
苯(k)苯駢芴 / Benzo[k]fluoranthene (CAS No.: 207-08-9)	mg/kg		0.2	n.d.	-
Chrysene (CAS No.: 218-01-9)	mg/kg		0.2	n.d.	-
二苯駢蔥 / Dibenzo[a,h]anthracene (CAS No.: 53-70-3)	mg/kg		0.2	n.d.	-
苯駢芴 / Fluoranthene (CAS No.: 206-44-0)	mg/kg		0.2	n.d.	-
芴 / Fluorene (CAS No.: 86-73-7)	mg/kg		0.2	n.d.	-
茚酮芘 / Indeno[1,2,3-c,d] pyrene (CAS No.: 193-39-5)	mg/kg		0.2	n.d.	-
萘 / Naphthalene (CAS No.: 91-20-3)	mg/kg		0.2	n.d.	-
菲 / Phenanthrene (CAS No.: 85-01-8)	mg/kg		0.2	n.d.	-
芘 / Pyrene (CAS No.: 129-00-0)	mg/kg		0.2	n.d.	-
苯(j)苯駢芴 / Benzo[j]fluoranthene (CAS No.: 205-82-3)	mg/kg		0.2	n.d.	-
苯駢(e)芘 / Benzo[e]pyrene (CAS No.: 192-97-2)	mg/kg		0.2	n.d.	-
多環芳香煙18項總和 / Sum of 18 PAHs	mg/kg		-	n.d.	-

This document is issued by the Company subject to its General Conditions of Service printed overleaf, available on request or accessible at <http://www.sgs.com/en/Terms-and-Conditions.aspx> and, for electronic format documents, subject to Terms and Conditions for Electronic Documents at <http://www.sgs.com/en/Terms-and-Conditions/Termse-Documents.aspx>. Attention is drawn to the limitation of liability, indemnification and jurisdiction issues defined therein. Any holder of this document is advised that information contained hereon reflects the Company's findings at the time of its intervention only and within the limits of client's instruction, if any. The Company's sole responsibility is to its Client and this document does not exonerate parties to a transaction from exercising all their rights and obligations under the transaction documents. This document cannot be reproduced, except in full, without prior written approval of the Company. Any unauthorized alteration, forgery or falsification of the content or appearance of this document is unlawful and offenders may be prosecuted to the fullest extent of the law. Unless otherwise stated the results shown in this test report refer only to the sample(s) tested.

## 測試報告

號碼(No.) : CE/2015/20344

日期(Date) : 2015/02/16

頁數(Page): 38 of 65

## Test Report



南亞塑膠工業股份有限公司(台灣) / NAN YA PLASTICS CORPORATION (TAIWAN)

(南亞電子材料(昆山)有限公司 / NAN YA ELECTRONIC MATERIALS (KUNSHAN) CORP., LTD)

(南亞電子材料(惠州)有限公司 / NAN YA ELECTRONIC MATERIALS (HUIZHOU) CORP., LTD)

台灣台北市敦化北路201號 / 201 TUNG HWA NORTH ROAD, TAIPEI, TAIWAN

(江蘇省昆山市長江南路201號 / 201 CHANG JIANG ROAD(S) KUNSHAN ECONOMIC & TECHNICAL DEVELOPMENT ZONE, JIANG SU)

(廣東省惠州市博羅縣石灣鎮永石大道 / YONGSHI BOULEVARD SHIWAN TOWN BOLUO COUNTY HUIZHOU CITY GUANG DONG)

### 備註(Note) :

1. mg/kg = ppm ; 0.1wt% = 1000ppm
2. n.d. = Not Detected (未檢出)
3. MDL = Method Detection Limit (方法偵測極限值)
4. "-" = Not Regulated (無規格值)
5. "\*" = Qualitative analysis (No Unit) 定性分析(無單位)
6. Negative = Undetectable 陰性(未偵測到); Positive = Detectable 陽性(已偵測到)
7. 石綿定性分析試驗範圍: <0.1%~100%, 石綿鑑定的判定基準是以檢出含有石綿纖維為『Positive』, 未檢出石綿纖維為『Negative』。 / Testing range of asbestos qualitative analysis is from less than 0.1% to 100%. The judgment criterion: asbestos fibers being found is shown as "Positive"; asbestos fibers not being found is shown as "Negative".
8. \*\*\*: 該物質是由三丁基錫, 砷, 硼或鉍各別之測試結果計算得知. 其MDL是針對三丁基錫, 砷, 硼或鉍之評估. (The substance was calculated by the test results of Tributyl Tin, Arsenic, Boron or Beryllium respectively. The MDL was evaluated for Tributyl Tin, Arsenic, Boron or Beryllium respectively.)
9. (\*2): 水合硼酸鈉: 依照歐洲化學總署解釋以無水四硼酸二鈉數據作為代表(歐洲化學總署回信編號 Ref no.: INC 000000032519) / Tetraboron disodium heptaoxide, hydrate: Only anhydrous form of disodium tetraborate is relevant and considered according to ECHA explanation (Ref no.: INC 000000032519).
10. (※2): 被萃取出之溶出硼/砷是以感應耦合電漿原子發射光譜儀檢測得之. / The extracted soluble Boron / Arsenic are detected by ICP-AES.
11. 參數換算表 / Parameter Conversion Table :  
Please refer to [http://twap.sgs.com/sgsrsts/chn/download-REACH\\_tw.asp](http://twap.sgs.com/sgsrsts/chn/download-REACH_tw.asp)
12. 鉍青銅是一種主要成份為鉍及銅的合金, 當偵測不到總鉍含量時, 亦表示不含鉍青銅.  
(Since beryllium copper is a metal alloy of copper and beryllium and the test result is n.d. for beryllium, we can have conclusion that the beryllium copper is n.d..)

## 測試報告

號碼(No.) : CE/2015/20344

日期(Date) : 2015/02/16

頁數(Page): 39 of 65

## Test Report



南亞塑膠工業股份有限公司(台灣) / NAN YA PLASTICS CORPORATION (TAIWAN)

(南亞電子材料(昆山)有限公司 / NAN YA ELECTRONIC MATERIALS (KUNSHAN) CORP., LTD)

(南亞電子材料(惠州)有限公司 / NAN YA ELECTRONIC MATERIALS (HUIZHOU) CORP., LTD)

台灣台北市敦化北路201號 / 201 TUNG HWA NORTH ROAD, TAIPEI, TAIWAN

(江蘇省昆山市長江南路201號 / 201 CHANG JIANG ROAD(S) KUNSHAN ECONOMIC & TECHNICAL DEVELOPMENT ZONE, JIANG SU)

(廣東省惠州市博羅縣石灣鎮永石大道 / YONGSHI BOULEVARD SHIWAN TOWN BOLUO COUNTY HUIZHOU CITY GUANG DONG)

**PAHs參考資料(Reference information) :**

**依據ZEK 01.4-08之要求: 產品中最大值為**

**(Requirement of ZEK 01.4-08 : Restraining maximum values for products)**

項目 (Parameter)	第1類 (Category 1)	第2類 (Category 2)	第3類 (Category 3)
	意圖放入嘴內的材料或與36個月以下的幼兒皮膚有所接觸的玩具。 (Material indented to be put in the mouth or toys for children aged < 36 months with intended skin contact.)	可預見與皮膚接觸逾30秒(長期與皮膚接觸), 以及不屬於第1類的材料。 (Materials not falling under category 1 with foreseeable contact to skin for longer than 30 seconds (long-term skin contact).)	可預見與皮膚接觸短於30秒(短期與皮膚接觸), 以及不屬於第1類或第2類的材料。(Materials not falling under category 1 or 2 with foreseeable contact to skin for less than 30 seconds (short-term skin contact).)
苯駢(a)芘 Benzo[a]pyrene (mg/kg)	<MDL (<0.2)**	1	20
18項PAH總濃度 (Sum of 18 PAH) (mg/kg)*	<MDL (<0.2)**	10	200

**注意(Remark):**

\* = PAH濃度大於0.2mg/kg時, 則須計算PAH總濃度值。

(Only PAH substances >0.2 mg/kg are taken into account while calculating the sum of PAHs.)

\*\* = 最大濃度值超出等級一的限制, 但在等級二的濃度限制值內時, 可能需要確認測試材質是否適用於與食品或與口腔黏膜接觸, 並依照EN 1186 ff. and § 64 LFBG 80.30-1方法, 針對特定PAH的遷移測試進行測試。遷移測試的結論需依照食品規範評估。

(If the limits of category 1 are surpassed but the limits of category 2 still met, the confirmation of suitability of contact with foodstuff or the oral mucosa can be verified by an additional specific migration test of the PAH components according to EN 1186 ff. and § 64 LFBG 80.30-1. The results of the migration test shall be evaluated according to law criteria for foodstuff.)

This document is issued by the Company subject to its General Conditions of Service printed overleaf, available on request or accessible at <http://www.sgs.com/en/Terms-and-Conditions.aspx> and, for electronic format documents, subject to Terms and Conditions for Electronic Documents at <http://www.sgs.com/en/Terms-and-Conditions/Termse-Document.aspx>. Attention is drawn to the limitation of liability, indemnification and jurisdiction issues defined therein. Any holder of this document is advised that information contained hereon reflects the Company's findings at the time of its intervention only and within the limits of client's instruction, if any. The Company's sole responsibility is to its Client and this document does not exonerate parties to a transaction from exercising all their rights and obligations under the transaction documents. This document cannot be reproduced, except in full, without prior written approval of the Company. Any unauthorized alteration, forgery or falsification of the content or appearance of this document is unlawful and offenders may be prosecuted to the fullest extent of the law. Unless otherwise stated the results shown in this test report refer only to the sample(s) tested.

## 測試報告

## Test Report

號碼(No.) : CE/2015/20344

日期(Date) : 2015/02/16

頁數(Page): 40 of 65



南亞塑膠工業股份有限公司(台灣) / NAN YA PLASTICS CORPORATION (TAIWAN)

(南亞電子材料(昆山)有限公司 / NAN YA ELECTRONIC MATERIALS (KUNSHAN) CORP., LTD)

(南亞電子材料(惠州)有限公司 / NAN YA ELECTRONIC MATERIALS (HUIZHOU) CORP., LTD)

台灣台北市敦化北路201號 / 201 TUNG HWA NORTH ROAD, TAIPEI, TAIWAN

(江蘇省昆山昆山市長江南路201號 / 201 CHANG JIANG ROAD(S) KUNSHAN ECONOMIC & TECHNICAL DEVELOPMENT ZONE, JIANG SU)

(廣東省惠州市博羅縣石灣鎮永石大道 / YONGSHI BOULEVARD SHIWAN TOWN BOLUO COUNTY HUIZHOU CITY GUANG DONG)

### PFOS參考資訊(Reference Information) : 持久性有機污染物 POPs - (EU) 757/2010

PFOS濃度在物質或製備中不得超過0.001%(10ppm), 在半成品、成品或零部件中不得超過0.1%(1000ppm), 在紡織品或塗層材料中不得超過 $1\mu\text{g}/\text{m}^2$ 。

(Outlawing PFOS as substances or preparations in concentrations above 0.001% (10ppm), in semi-finished products or articles or parts at a level above 0.1%(1000ppm), in textiles or other coated materials above  $1\mu\text{g}/\text{m}^2$ .)



## 測試報告 Test Report

號碼(No.) : CE/2015/20344

日期(Date) : 2015/02/16

頁數(Page): 41 of 65



南亞塑膠工業股份有限公司(台灣) / NAN YA PLASTICS CORPORATION (TAIWAN)  
 (南亞電子材料(昆山)有限公司) / NAN YA ELECTRONIC MATERIALS (KUNSHAN) CORP., LTD)  
 (南亞電子材料(惠州)有限公司) / NAN YA ELECTRONIC MATERIALS (HUIZHOU) CORP., LTD)  
 台灣台北市敦化北路201號 / 201 TUNG HWA NORTH ROAD, TAIPEI, TAIWAN  
 (江蘇省昆山市市長江南路201號) / 201 CHANG JIANG ROAD(S) KUNSHAN ECONOMIC & TECHNICAL DEVELOPMENT ZONE, JIANG SU)  
 (廣東省惠州市博羅縣石灣鎮永石大道) / YONGSHI BOULEVARD SHIWAN TOWN BOLUO COUNTY HUIZHOU CITY GUANG DONG)

- 1) 根據以下的流程圖之條件, 樣品已完全溶解。(六價鉻測試方法除外) / These samples were dissolved totally by pre-conditioning method according to below flow chart. (Cr<sup>6+</sup> test method excluded)
- 2) 測試人員: 楊登偉 / Name of the person who made measurement: Climbgreat Yang
- 3) 測試負責人: 張啓興 / Name of the person in charge of measurement: Troy Chang

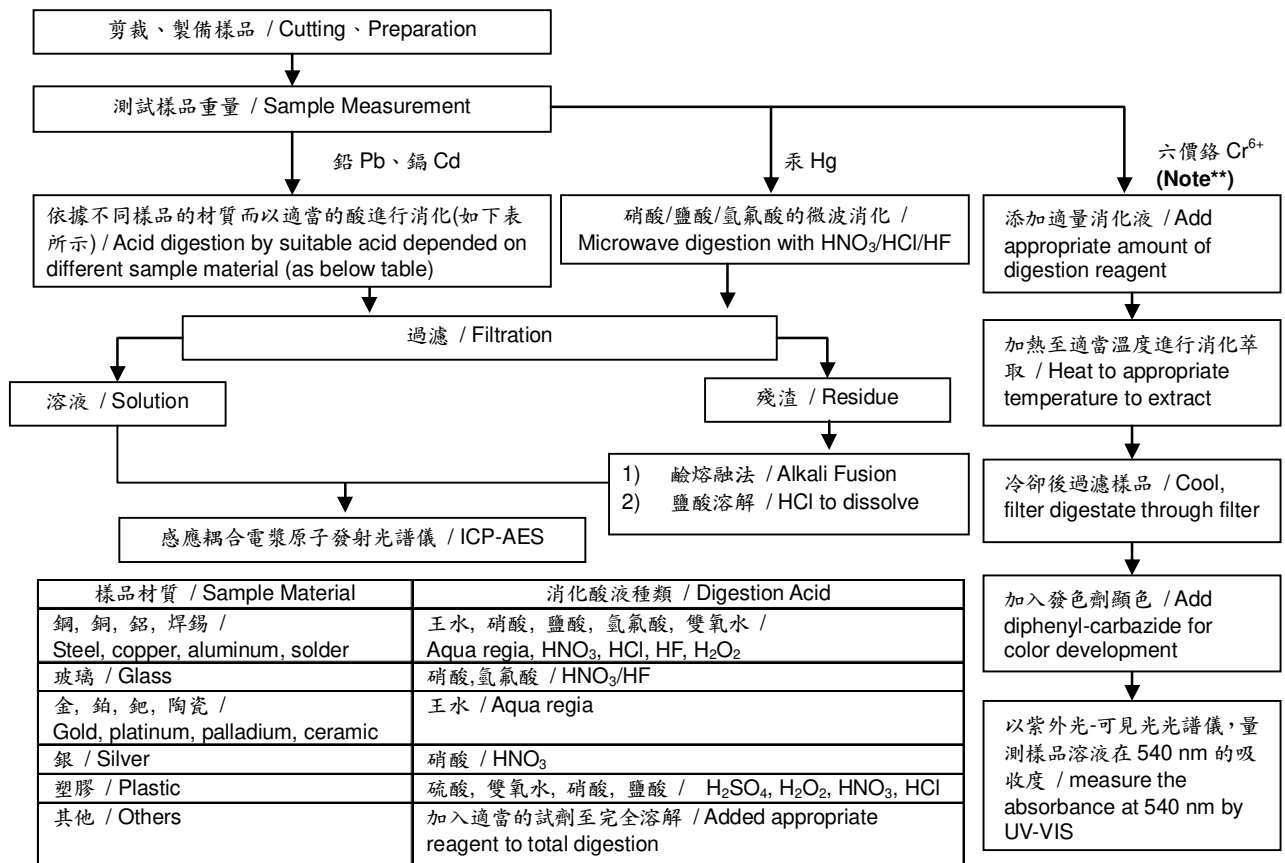

**Note\*\* (For IEC 62321)**

- (1) 針對非金屬材料加入鹼性消化液, 加熱至 90~95°C 萃取. / For non-metallic material, add alkaline digestion reagent and heat to 90~95°C.
- (2) 針對金屬材料加入純水, 加熱至沸騰萃取. / For metallic material, add pure water and heat to boiling.

## 測試報告

## Test Report

號碼(No.) : CE/2015/20344

日期(Date) : 2015/02/16

頁數(Page): 42 of 65



南亞塑膠工業股份有限公司(台灣) / NAN YA PLASTICS CORPORATION (TAIWAN)

(南亞電子材料(昆山)有限公司 / NAN YA ELECTRONIC MATERIALS (KUNSHAN) CORP., LTD)

(南亞電子材料(惠州)有限公司 / NAN YA ELECTRONIC MATERIALS (HUIZHOU) CORP., LTD)

台灣台北市敦化北路201號 / 201 TUNG HWA NORTH ROAD, TAIPEI, TAIWAN

(江蘇省昆山市市長江南路201號 / 201 CHANG JIANG ROAD(S) KUNSHAN ECONOMIC & TECHNICAL DEVELOPMENT ZONE, JIANG SU)

(廣東省惠州市博羅縣石灣鎮永石大道 / YONGSHI BOULEVARD SHIWAN TOWN BOLUO COUNTY HUIZHOU CITY GUANG DONG)

- 1) 根據以下的流程圖之條件，樣品已完全溶解。 / These samples were dissolved totally by pre-conditioning method according to below flow chart.
- 2) 測試人員：楊登偉 / Name of the person who made measurement: Climbgreat Yang
- 3) 測試負責人：張啓興 / Name of the person in charge of measurement: Troy Chang

### 元素以 ICP-AES 分析的消化流程圖

(Flow Chart of digestion for the elements analysis performed by ICP-AES)

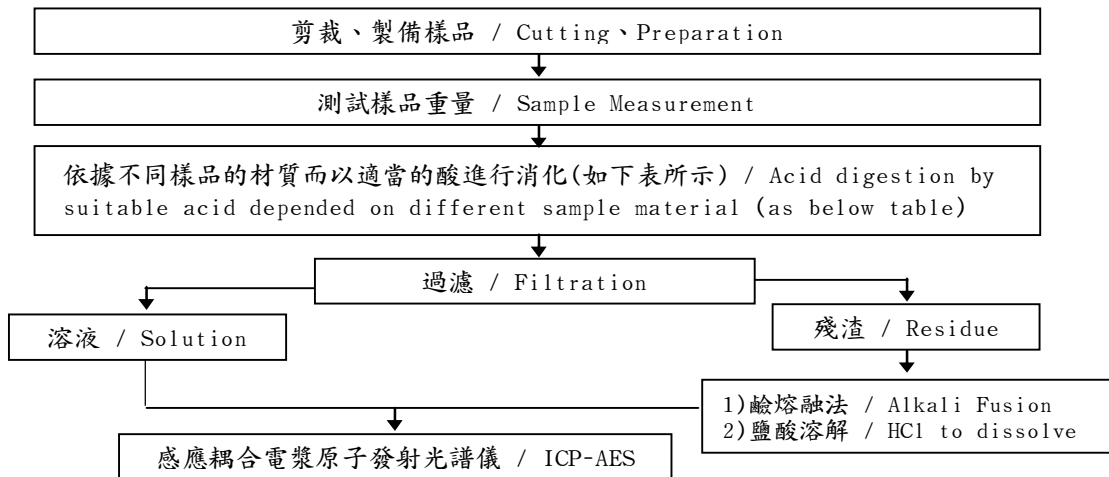

鋼,銅,鋁,焊錫 / Steel, copper, aluminum, solder	王水,硝酸,鹽酸,氫氟酸,雙氧水 / Aqua regia, HNO <sub>3</sub> , HCl, HF, H <sub>2</sub> O <sub>2</sub>
玻璃 / Glass	硝酸,氫氟酸 / HNO <sub>3</sub> /HF
金,鉑,鈀,陶瓷 / Gold, platinum, palladium, ceramic	王水 / Aqua regia
銀 / Silver	硝酸 / HNO <sub>3</sub>
塑膠 / Plastic	硫酸,雙氧水,硝酸,鹽酸 / H <sub>2</sub> SO <sub>4</sub> , H <sub>2</sub> O <sub>2</sub> , HNO <sub>3</sub> , HCl
其他 / Others	加入適當的試劑至完全溶解 / Added appropriate reagent to total digestion

## 測試報告

## Test Report

號碼(No.) : CE/2015/20344

日期(Date) : 2015/02/16

頁數(Page): 43 of 65



南亞塑膠工業股份有限公司(台灣) / NAN YA PLASTICS CORPORATION (TAIWAN)

(南亞電子材料(昆山)有限公司 / NAN YA ELECTRONIC MATERIALS (KUNSHAN) CORP., LTD)

(南亞電子材料(惠州)有限公司 / NAN YA ELECTRONIC MATERIALS (HUIZHOU) CORP., LTD)

台灣台北市敦化北路201號 / 201 TUNG HWA NORTH ROAD, TAIPEI, TAIWAN

(江蘇省昆山昆山市長江南路201號 / 201 CHANG JIANG ROAD(S) KUNSHAN ECONOMIC & TECHNICAL DEVELOPMENT ZONE, JIANG SU)

(廣東省惠州市博羅縣石灣鎮永石大道 / YONGSHI BOULEVARD SHIWAN TOWN BOLUO COUNTY HUIZHOU CITY GUANG DONG)

### 雙酚A分析流程圖 / Bisphenol A analytical flow chart

- 測試人員：林建宇 / Name of the person who made measurement: Roy Lin
- 測試負責人：張啓興 / Name of the person in charge of measurement: Troy Chang

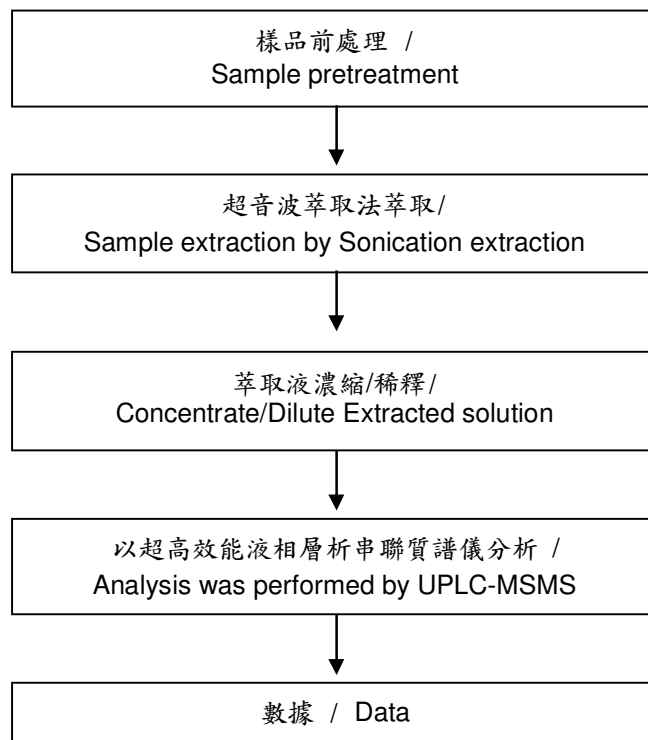

This document is issued by the Company subject to its General Conditions of Service printed overleaf, available on request or accessible at <http://www.sgs.com/en/Terms-and-Conditions.aspx> and, for electronic format documents, subject to Terms and Conditions for Electronic Documents at <http://www.sgs.com/en/Terms-and-Conditions/Termse-Documents.aspx>. Attention is drawn to the limitation of liability, indemnification and jurisdiction issues defined therein. Any holder of this document is advised that information contained hereon reflects the Company's findings at the time of its intervention only and within the limits of client's instruction, if any. The Company's sole responsibility is to its Client and this document does not exonerate parties to a transaction from exercising all their rights and obligations under the transaction documents. This document cannot be reproduced, except in full, without prior written approval of the Company. Any unauthorized alteration, forgery or falsification of the content or appearance of this document is unlawful and offenders may be prosecuted to the fullest extent of the law. Unless otherwise stated the results shown in this test report refer only to the sample(s) tested.

## 測試報告

## Test Report

號碼(No.) : CE/2015/20344

日期(Date) : 2015/02/16

頁數(Page): 44 of 65



南亞塑膠工業股份有限公司(台灣) / NAN YA PLASTICS CORPORATION (TAIWAN)

(南亞電子材料(昆山)有限公司 / NAN YA ELECTRONIC MATERIALS (KUNSHAN) CORP., LTD)

(南亞電子材料(惠州)有限公司 / NAN YA ELECTRONIC MATERIALS (HUIZHOU) CORP., LTD)

台灣台北市敦化北路201號 / 201 TUNG HWA NORTH ROAD, TAIPEI, TAIWAN

(江蘇省昆山昆山市長江南路201號 / 201 CHANG JIANG ROAD(S) KUNSHAN ECONOMIC & TECHNICAL DEVELOPMENT ZONE, JIANG SU)

(廣東省惠州市博羅縣石灣鎮永石大道 / YONGSHI BOULEVARD SHIWAN TOWN BOLUO COUNTY HUIZHOU CITY GUANG DONG)

### 四溴雙酚-A 分析流程圖 / TBBP-A analytical flow chart

- 測試人員：林建宇 / Name of the person who made measurement: Roy Lin
- 測試負責人：張啓興 / Name of the person in charge of measurement: Troy Chang

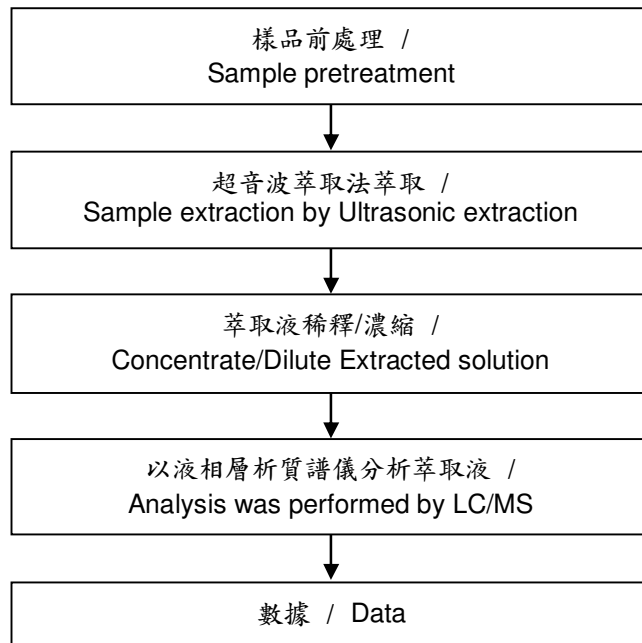

## 測試報告

## Test Report

號碼(No.) : CE/2015/20344

日期(Date) : 2015/02/16

頁數(Page): 45 of 65



南亞塑膠工業股份有限公司(台灣) / NAN YA PLASTICS CORPORATION (TAIWAN)

(南亞電子材料(昆山)有限公司) / NAN YA ELECTRONIC MATERIALS (KUNSHAN) CORP., LTD)

(南亞電子材料(惠州)有限公司) / NAN YA ELECTRONIC MATERIALS (HUIZHOU) CORP., LTD)

台灣台北市敦化北路201號 / 201 TUNG HWA NORTH ROAD, TAIPEI, TAIWAN

(江蘇省昆山昆山市長江南路201號 / 201 CHANG JIANG ROAD(S) KUNSHAN ECONOMIC & TECHNICAL DEVELOPMENT ZONE, JIANG SU)

(廣東省惠州市博羅縣石灣鎮永石大道 / YONGSHI BOULEVARD SHIWAN TOWN BOLUO COUNTY HUIZHOU CITY GUANG DONG)

### 多環芳香烴分析流程圖 / PAHs (Polynuclear Aromatic Hydrocarbons) analytical flow chart

- 測試人員：翁賜彬 / Name of the person who made measurement: Roman Wong
- 測試負責人：張啓興 / Name of the person in charge of measurement: Troy Chang

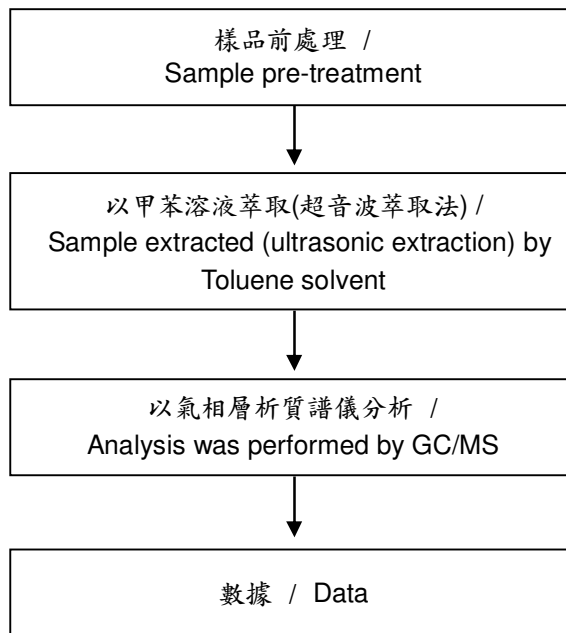

## 測試報告

## Test Report

號碼(No.) : CE/2015/20344

日期(Date) : 2015/02/16

頁數(Page): 46 of 65



南亞塑膠工業股份有限公司(台灣) / NAN YA PLASTICS CORPORATION (TAIWAN)

(南亞電子材料(昆山)有限公司 / NAN YA ELECTRONIC MATERIALS (KUNSHAN) CORP., LTD)

(南亞電子材料(惠州)有限公司 / NAN YA ELECTRONIC MATERIALS (HUIZHOU) CORP., LTD)

台灣台北市敦化北路201號 / 201 TUNG HWA NORTH ROAD, TAIPEI, TAIWAN

(江蘇省昆山昆山市長江南路201號 / 201 CHANG JIANG ROAD(S) KUNSHAN ECONOMIC & TECHNICAL DEVELOPMENT ZONE, JIANG SU)

(廣東省惠州市博羅縣石灣鎮永石大道 / YONGSHI BOULEVARD SHIWAN TOWN BOLUO COUNTY HUIZHOU CITY GUANG DONG)

### 乙二醇醚及其酯類分析流程圖 / Ethylene glycol ether analytical flow chart

- 測試人員：翁賜彬 / Name of the person who made measurement: Roman Wong
- 測試負責人：張啓興 / Name of the person in charge of measurement: Troy Chang

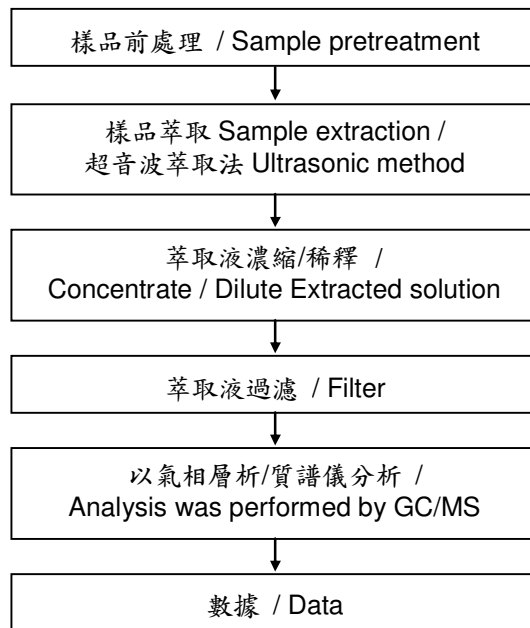



## 測試報告

## Test Report

號碼(No.) : CE/2015/20344

日期(Date) : 2015/02/16

頁數(Page): 47 of 65



南亞塑膠工業股份有限公司(台灣) / NAN YA PLASTICS CORPORATION (TAIWAN)

(南亞電子材料(昆山)有限公司 / NAN YA ELECTRONIC MATERIALS (KUNSHAN) CORP., LTD)

(南亞電子材料(惠州)有限公司 / NAN YA ELECTRONIC MATERIALS (HUIZHOU) CORP., LTD)

台灣台北市敦化北路201號 / 201 TUNG HWA NORTH ROAD, TAIPEI, TAIWAN

(江蘇省昆山昆山市長江南路201號 / 201 CHANG JIANG ROAD(S) KUNSHAN ECONOMIC & TECHNICAL DEVELOPMENT ZONE, JIANG SU)

(廣東省惠州市博羅縣石灣鎮永石大道 / YONGSHI BOULEVARD SHIWAN TOWN BOLUO COUNTY HUIZHOU CITY GUANG DONG)

### 可塑劑分析流程圖 / Analytical flow chart of phthalate content

- 測試人員：徐毓明 / Name of the person who made measurement: Andy Shu
- 測試負責人：張啓興 / Name of the person in charge of measurement: Troy Chang

#### 【測試方法/Test method: IEC 62321-8】

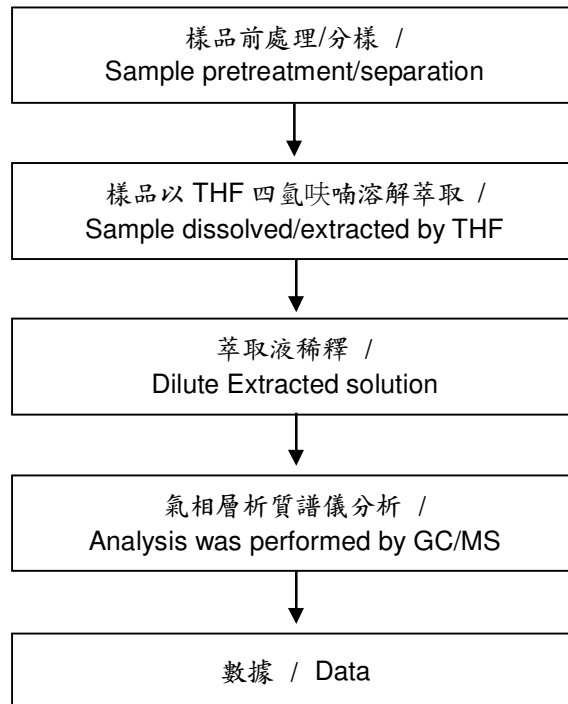

## 測試報告

## Test Report

號碼(No.) : CE/2015/20344

日期(Date) : 2015/02/16

頁數(Page): 48 of 65



南亞塑膠工業股份有限公司(台灣) / NAN YA PLASTICS CORPORATION (TAIWAN)

(南亞電子材料(昆山)有限公司 / NAN YA ELECTRONIC MATERIALS (KUNSHAN) CORP., LTD)

(南亞電子材料(惠州)有限公司 / NAN YA ELECTRONIC MATERIALS (HUIZHOU) CORP., LTD)

台灣台北市敦化北路201號 / 201 TUNG HWA NORTH ROAD, TAIPEI, TAIWAN

(江蘇省昆山昆山市長江南路201號 / 201 CHANG JIANG ROAD(S) KUNSHAN ECONOMIC & TECHNICAL DEVELOPMENT ZONE, JIANG SU)

(廣東省惠州市博羅縣石灣鎮永石大道 / YONGSHI BOULEVARD SHIWAN TOWN BOLUO COUNTY HUIZHOU CITY GUANG DONG)

### 可塑劑分析流程圖 / Analytical flow chart of phthalate content

- 測試人員：翁賜彬 / Name of the person who made measurement: Roman Wong
- 測試負責人：張啓興 / Name of the person in charge of measurement: Troy Chang

#### 【測試方法/Test method: EN 14372】

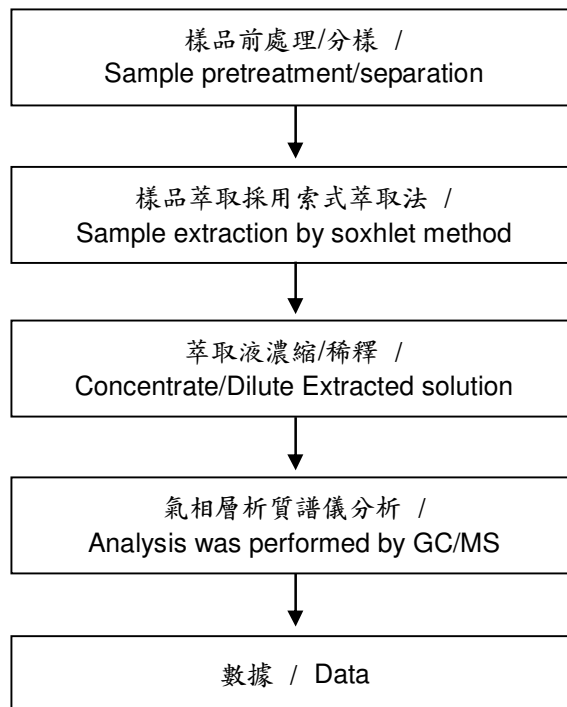

This document is issued by the Company subject to its General Conditions of Service printed overleaf, available on request or accessible at <http://www.sgs.com/en/Terms-and-Conditions.aspx> and, for electronic format documents, subject to Terms and Conditions for Electronic Documents at <http://www.sgs.com/en/Terms-and-Conditions/Termse-Documents.aspx>. Attention is drawn to the limitation of liability, indemnification and jurisdiction issues defined therein. Any holder of this document is advised that information contained hereon reflects the Company's findings at the time of its intervention only and within the limits of client's instruction, if any. The Company's sole responsibility is to its Client and this document does not exonerate parties to a transaction from exercising all their rights and obligations under the transaction documents. This document cannot be reproduced, except in full, without prior written approval of the Company. Any unauthorized alteration, forgery or falsification of the content or appearance of this document is unlawful and offenders may be prosecuted to the fullest extent of the law. Unless otherwise stated the results shown in this test report refer only to the sample(s) tested.

## 測試報告

## Test Report

號碼(No.) : CE/2015/20344

日期(Date) : 2015/02/16

頁數(Page): 49 of 65



南亞塑膠工業股份有限公司(台灣) / NAN YA PLASTICS CORPORATION (TAIWAN)

(南亞電子材料(昆山)有限公司 / NAN YA ELECTRONIC MATERIALS (KUNSHAN) CORP., LTD)

(南亞電子材料(惠州)有限公司 / NAN YA ELECTRONIC MATERIALS (HUIZHOU) CORP., LTD)

台灣台北市敦化北路201號 / 201 TUNG HWA NORTH ROAD, TAIPEI, TAIWAN

(江蘇省昆山昆山市長江南路201號 / 201 CHANG JIANG ROAD(S) KUNSHAN ECONOMIC & TECHNICAL DEVELOPMENT ZONE, JIANG SU)

(廣東省惠州市博羅縣石灣鎮永石大道 / YONGSHI BOULEVARD SHIWAN TOWN BOLUO COUNTY HUIZHOU CITY GUANG DONG)

### 鹵素分析流程圖 / Analytical flow chart of halogen content

- 測試人員：陳恩臻 / Name of the person who made measurement: Rita Chen
- 測試負責人：張啓興 / Name of the person in charge of measurement: Troy Chang

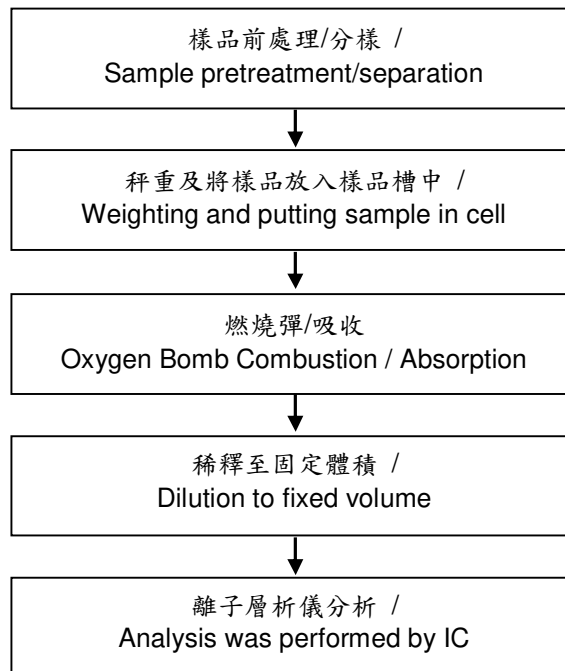

## 測試報告

## Test Report

號碼(No.) : CE/2015/20344

日期(Date) : 2015/02/16

頁數(Page): 50 of 65



南亞塑膠工業股份有限公司(台灣) / NAN YA PLASTICS CORPORATION (TAIWAN)

(南亞電子材料(昆山)有限公司 / NAN YA ELECTRONIC MATERIALS (KUNSHAN) CORP., LTD)

(南亞電子材料(惠州)有限公司 / NAN YA ELECTRONIC MATERIALS (HUIZHOU) CORP., LTD)

台灣台北市敦化北路201號 / 201 TUNG HWA NORTH ROAD, TAIPEI, TAIWAN

(江蘇省昆山昆山市長江南路201號 / 201 CHANG JIANG ROAD(S) KUNSHAN ECONOMIC & TECHNICAL DEVELOPMENT ZONE, JIANG SU)

(廣東省惠州市博羅縣石灣鎮永石大道 / YONGSHI BOULEVARD SHIWAN TOWN BOLUO COUNTY HUIZHOU CITY GUANG DONG)

### 六溴環十二烷分析流程圖 / HBCDD analytical flow chart

- 測試人員：翁賜彬 / Name of the person who made measurement: Roman Wong
- 測試負責人：張啓興 / Name of the person in charge of measurement: Troy Chang

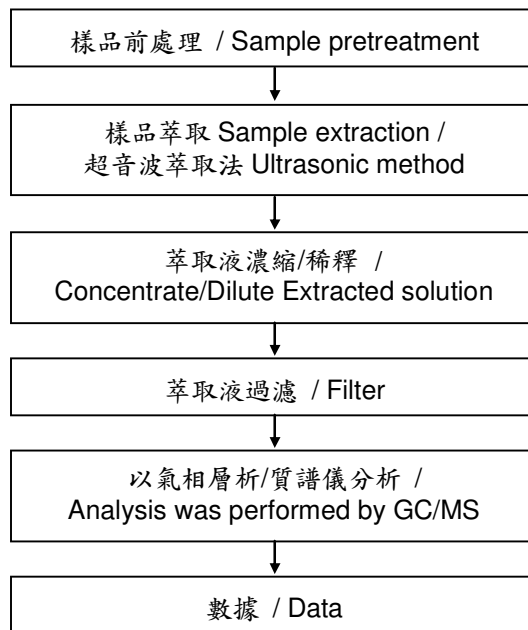

## 測試報告

## Test Report

號碼(No.) : CE/2015/20344

日期(Date) : 2015/02/16

頁數(Page): 51 of 65



南亞塑膠工業股份有限公司(台灣) / NAN YA PLASTICS CORPORATION (TAIWAN)

(南亞電子材料(昆山)有限公司 / NAN YA ELECTRONIC MATERIALS (KUNSHAN) CORP., LTD)

(南亞電子材料(惠州)有限公司 / NAN YA ELECTRONIC MATERIALS (HUIZHOU) CORP., LTD)

台灣台北市敦化北路201號 / 201 TUNG HWA NORTH ROAD, TAIPEI, TAIWAN

(江蘇省昆山市長江南路201號 / 201 CHANG JIANG ROAD(S) KUNSHAN ECONOMIC & TECHNICAL DEVELOPMENT ZONE, JIANG SU)

(廣東省惠州市博羅縣石灣鎮永石大道 / YONGSHI BOULEVARD SHIWAN TOWN BOLUO COUNTY HUIZHOU CITY GUANG DONG)

### 富馬酸二甲酯分析流程圖 / Dimethyl Fumarate analytical flow chart

- 測試人員：翁賜彬 / Name of the person who made measurement: Roman Wong
- 測試負責人：張啓興 / Name of the person in charge of measurement: Troy Chang

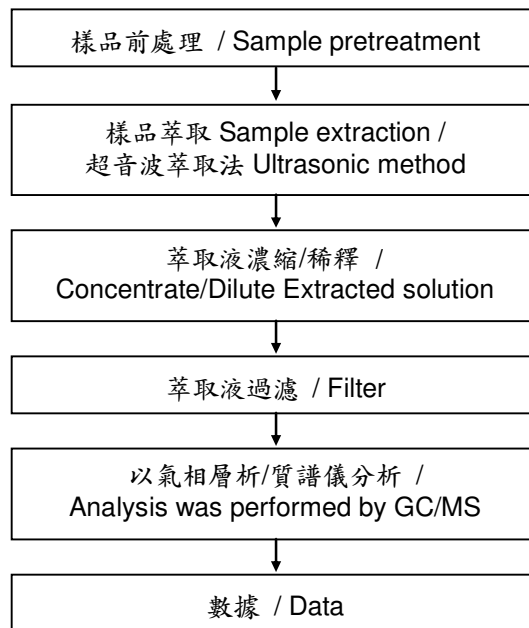

## 測試報告

## Test Report

號碼(No.) : CE/2015/20344

日期(Date) : 2015/02/16

頁數(Page): 52 of 65



南亞塑膠工業股份有限公司(台灣) / NAN YA PLASTICS CORPORATION (TAIWAN)

(南亞電子材料(昆山)有限公司 / NAN YA ELECTRONIC MATERIALS (KUNSHAN) CORP., LTD)

(南亞電子材料(惠州)有限公司 / NAN YA ELECTRONIC MATERIALS (HUIZHOU) CORP., LTD)

台灣台北市敦化北路201號 / 201 TUNG HWA NORTH ROAD, TAIPEI, TAIWAN

(江蘇省昆山昆山市長江南路201號 / 201 CHANG JIANG ROAD(S) KUNSHAN ECONOMIC & TECHNICAL DEVELOPMENT ZONE, JIANG SU)

(廣東省惠州市博羅縣石灣鎮永石大道 / YONGSHI BOULEVARD SHIWAN TOWN BOLUO COUNTY HUIZHOU CITY GUANG DONG)

### 揮發性有機化合物分析流程圖 / Analytical flow chart of volatile organic compounds (VOCs)

- 測試人員：吳椿景 / Name of the person who made measurement : Chun Wu
  - 測試負責人：陳新智 / Name of the person in charge of measurement : Shinjyh Chen
- 【參考方法(Reference method) : US EPA 5021】

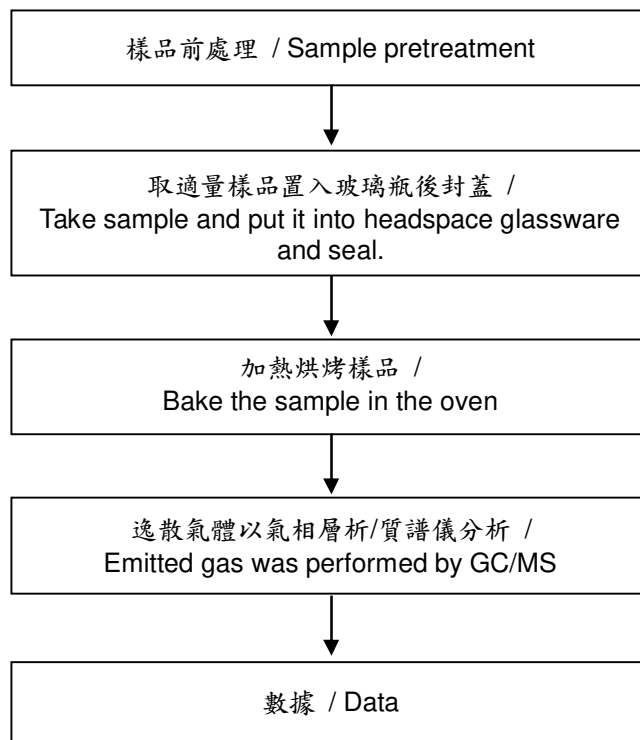

This document is issued by the Company subject to its General Conditions of Service printed overleaf, available on request or accessible at <http://www.sgs.com/en/Terms-and-Conditions.aspx> and, for electronic format documents, subject to Terms and Conditions for Electronic Documents at <http://www.sgs.com/en/Terms-and-Conditions/Termse-Document.aspx>. Attention is drawn to the limitation of liability, indemnification and jurisdiction issues defined therein. Any holder of this document is advised that information contained hereon reflects the Company's findings at the time of its intervention only and within the limits of client's instruction, if any. The Company's sole responsibility is to its Client and this document does not exonerate parties to a transaction from exercising all their rights and obligations under the transaction documents. This document cannot be reproduced, except in full, without prior written approval of the Company. Any unauthorized alteration, forgery or falsification of the content or appearance of this document is unlawful and offenders may be prosecuted to the fullest extent of the law. Unless otherwise stated the results shown in this test report refer only to the sample(s) tested.



## 測試報告

## Test Report

號碼(No.) : CE/2015/20344

日期(Date) : 2015/02/16

頁數(Page): 53 of 65



南亞塑膠工業股份有限公司(台灣) / NAN YA PLASTICS CORPORATION (TAIWAN)

(南亞電子材料(昆山)有限公司 / NAN YA ELECTRONIC MATERIALS (KUNSHAN) CORP., LTD)

(南亞電子材料(惠州)有限公司 / NAN YA ELECTRONIC MATERIALS (HUIZHOU) CORP., LTD)

台灣台北市敦化北路201號 / 201 TUNG HWA NORTH ROAD, TAIPEI, TAIWAN

(江蘇省昆山昆山市長江南路201號 / 201 CHANG JIANG ROAD(S) KUNSHAN ECONOMIC & TECHNICAL DEVELOPMENT ZONE, JIANG SU)

(廣東省惠州市博羅縣石灣鎮永石大道 / YONGSHI BOULEVARD SHIWAN TOWN BOLUO COUNTY HUIZHOU CITY GUANG DONG)

### 二氯化鈷分析流程圖 / Analytical flow chart of Cobalt dichloride

- 測試人員：楊登偉 / Name of the person who made measurement: Climbgreat Yang
- 測試負責人：張啓興 / Name of the person in charge of measurement: Troy Chang

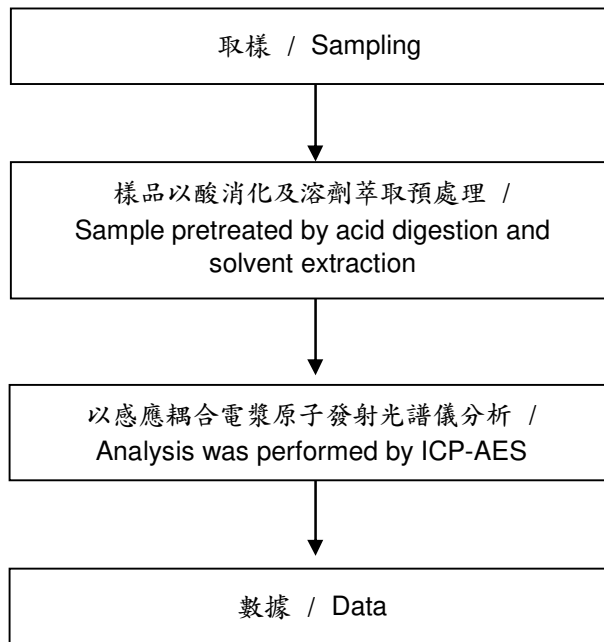

## 測試報告

## Test Report

號碼(No.) : CE/2015/20344

日期(Date) : 2015/02/16

頁數(Page): 54 of 65



南亞塑膠工業股份有限公司(台灣) / NAN YA PLASTICS CORPORATION (TAIWAN)

(南亞電子材料(昆山)有限公司 / NAN YA ELECTRONIC MATERIALS (KUNSHAN) CORP., LTD)

(南亞電子材料(惠州)有限公司 / NAN YA ELECTRONIC MATERIALS (HUIZHOU) CORP., LTD)

台灣台北市敦化北路201號 / 201 TUNG HWA NORTH ROAD, TAIPEI, TAIWAN

(江蘇省昆山昆山市長江南路201號 / 201 CHANG JIANG ROAD(S) KUNSHAN ECONOMIC & TECHNICAL DEVELOPMENT ZONE, JIANG SU)

(廣東省惠州市博羅縣石灣鎮永石大道 / YONGSHI BOULEVARD SHIWAN TOWN BOLUO COUNTY HUIZHOU CITY GUANG DONG)

### 苯並三唑類化合物分析流程圖 / Benzotriazole analytical flow chart

- 測試人員：翁賜彬 / Name of the person who made measurement: Roman Wong
- 測試負責人：張啓興 / Name of the person in charge of measurement: Troy Chang

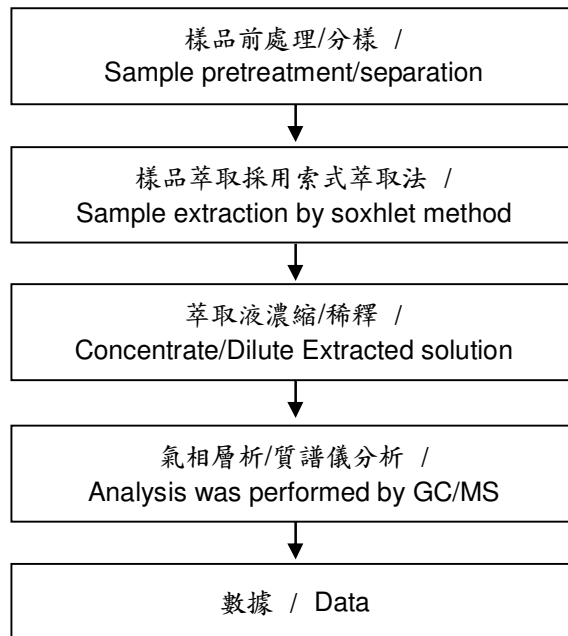

## 測試報告

## Test Report

號碼(No.) : CE/2015/20344

日期(Date) : 2015/02/16

頁數(Page): 55 of 65



南亞塑膠工業股份有限公司(台灣) / NAN YA PLASTICS CORPORATION (TAIWAN)  
 (南亞電子材料(昆山)有限公司) / NAN YA ELECTRONIC MATERIALS (KUNSHAN) CORP., LTD)  
 (南亞電子材料(惠州)有限公司) / NAN YA ELECTRONIC MATERIALS (HUIZHOU) CORP., LTD)  
 台灣台北市敦化北路201號 / 201 TUNG HWA NORTH ROAD, TAIPEI, TAIWAN  
 (江蘇省昆山市長江南路201號 / 201 CHANG JIANG ROAD(S) KUNSHAN ECONOMIC & TECHNICAL DEVELOPMENT ZONE, JIANG SU)  
 (廣東省惠州市博羅縣石灣鎮永石大道 / YONGSHI BOULEVARD SHIWAN TOWN BOLUO COUNTY HUIZHOU CITY GUANG DONG)

### 全氟辛酸/全氟辛烷磺酸分析流程圖 / PFOA/PFOS analytical flow chart

- 測試人員：翁賜彬 / Name of the person who made measurement: Roman Wong
- 測試負責人：張啓興 / Name of the person in charge of measurement: Troy Chang

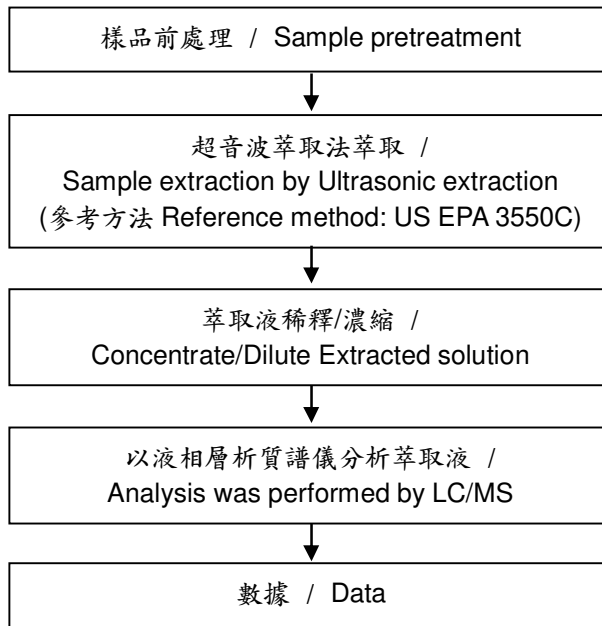

## 測試報告

## Test Report

號碼(No.) : CE/2015/20344

日期(Date) : 2015/02/16

頁數(Page): 56 of 65



南亞塑膠工業股份有限公司(台灣) / NAN YA PLASTICS CORPORATION (TAIWAN)

(南亞電子材料(昆山)有限公司 / NAN YA ELECTRONIC MATERIALS (KUNSHAN) CORP., LTD)

(南亞電子材料(惠州)有限公司 / NAN YA ELECTRONIC MATERIALS (HUIZHOU) CORP., LTD)

台灣台北市敦化北路201號 / 201 TUNG HWA NORTH ROAD, TAIPEI, TAIWAN

(江蘇省昆山昆山市長江南路201號 / 201 CHANG JIANG ROAD(S) KUNSHAN ECONOMIC & TECHNICAL DEVELOPMENT ZONE, JIANG SU)

(廣東省惠州市博羅縣石灣鎮永石大道 / YONGSHI BOULEVARD SHIWAN TOWN BOLUO COUNTY HUIZHOU CITY GUANG DONG)

### 石綿鑑定分析流程圖 / Analysis flow chart for determination of Asbestos

- 測試人員：高鍵忠 / Name of the person who made measurement: Victor Kao
- 測試負責人：魏明芬 / Name of the person in charge of measurement: Wendy Wei

#### 【參考方法(Reference method): EPA 600/R-93/116】

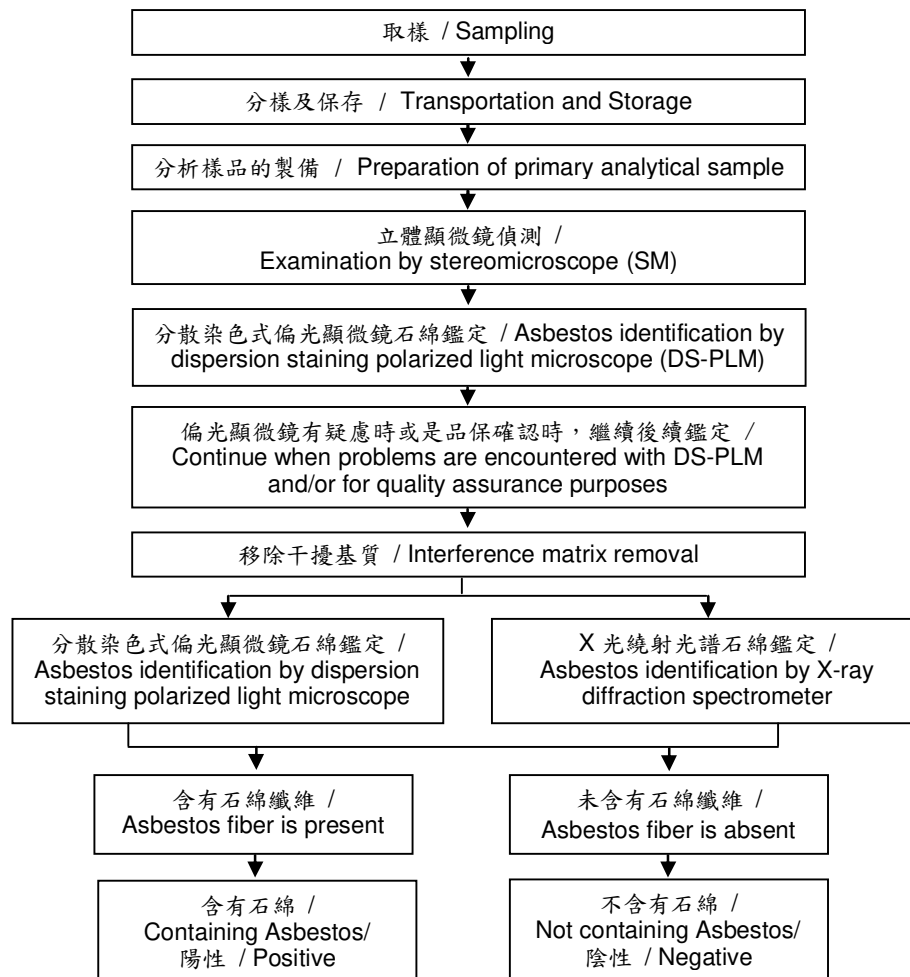

This document is issued by the Company subject to its General Conditions of Service printed overleaf, available on request or accessible at <http://www.sgs.com/en/Terms-and-Conditions.aspx> and, for electronic format documents, subject to Terms and Conditions for Electronic Documents at <http://www.sgs.com/en/Terms-and-Conditions/Termse-Documents.aspx>. Attention is drawn to the limitation of liability, indemnification and jurisdiction issues defined therein. Any holder of this document is advised that information contained hereon reflects the Company's findings at the time of its intervention only and within the limits of client's instruction, if any. The Company's sole responsibility is to its Client and this document does not exonerate parties to a transaction from exercising all their rights and obligations under the transaction documents. This document cannot be reproduced, except in full, without prior written approval of the Company. Any unauthorized alteration, forgery or falsification of the content or appearance of this document is unlawful and offenders may be prosecuted to the fullest extent of the law. Unless otherwise stated the results shown in this test report refer only to the sample(s) tested.

## 測試報告

## Test Report

號碼(No.) : CE/2015/20344

日期(Date) : 2015/02/16

頁數(Page): 57 of 65



南亞塑膠工業股份有限公司(台灣) / NAN YA PLASTICS CORPORATION (TAIWAN)

(南亞電子材料(昆山)有限公司 / NAN YA ELECTRONIC MATERIALS (KUNSHAN) CORP., LTD)

(南亞電子材料(惠州)有限公司 / NAN YA ELECTRONIC MATERIALS (HUIZHOU) CORP., LTD)

台灣台北市敦化北路201號 / 201 TUNG HWA NORTH ROAD, TAIPEI, TAIWAN

(江蘇省昆山昆山市長江南路201號 / 201 CHANG JIANG ROAD(S) KUNSHAN ECONOMIC & TECHNICAL DEVELOPMENT ZONE, JIANG SU)

(廣東省惠州市博羅縣石灣鎮永石大道 / YONGSHI BOULEVARD SHIWAN TOWN BOLUO COUNTY HUIZHOU CITY GUANG DONG)

### 有機錫分析流程圖 / Analytical flow chart of Organic-Tin content

- 測試人員：林建宇 / Name of the person who made measurement: Roy Lin
- 測試負責人：張啓興 / Name of the person in charge of measurement: Troy Chang

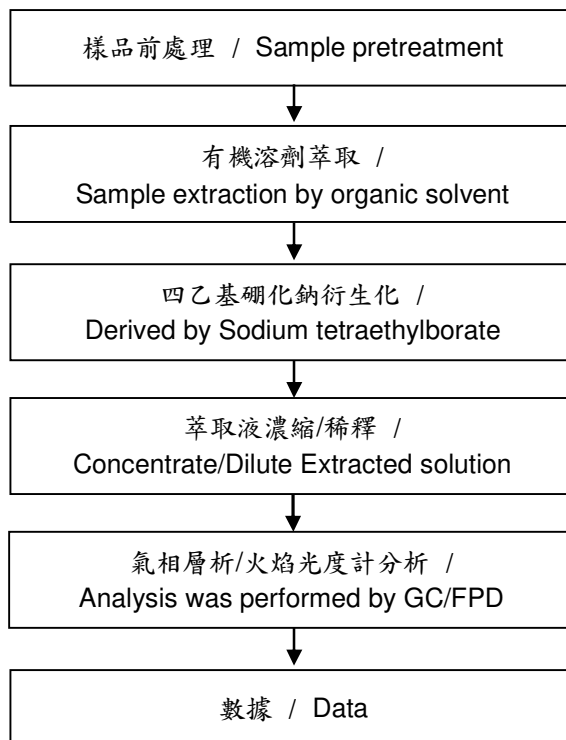

This document is issued by the Company subject to its General Conditions of Service printed overleaf, available on request or accessible at <http://www.sgs.com/en/Terms-and-Conditions.aspx> and, for electronic format documents, subject to Terms and Conditions for Electronic Documents at <http://www.sgs.com/en/Terms-and-Conditions/Termse-Document.aspx>. Attention is drawn to the limitation of liability, indemnification and jurisdiction issues defined therein. Any holder of this document is advised that information contained hereon reflects the Company's findings at the time of its intervention only and within the limits of client's instruction, if any. The Company's sole responsibility is to its Client and this document does not exonerate parties to a transaction from exercising all their rights and obligations under the transaction documents. This document cannot be reproduced, except in full, without prior written approval of the Company. Any unauthorized alteration, forgery or falsification of the content or appearance of this document is unlawful and offenders may be prosecuted to the fullest extent of the law. Unless otherwise stated the results shown in this test report refer only to the sample(s) tested.

## 測試報告

## Test Report

號碼(No.) : CE/2015/20344

日期(Date) : 2015/02/16

頁數(Page): 58 of 65



南亞塑膠工業股份有限公司(台灣) / NAN YA PLASTICS CORPORATION (TAIWAN)

(南亞電子材料(昆山)有限公司) / NAN YA ELECTRONIC MATERIALS (KUNSHAN) CORP., LTD)

(南亞電子材料(惠州)有限公司) / NAN YA ELECTRONIC MATERIALS (HUIZHOU) CORP., LTD)

台灣台北市敦化北路201號 / 201 TUNG HWA NORTH ROAD, TAIPEI, TAIWAN

(江蘇省昆山市長江南路201號 / 201 CHANG JIANG ROAD(S) KUNSHAN ECONOMIC & TECHNICAL DEVELOPMENT ZONE, JIANG SU)

(廣東省惠州市博羅縣石灣鎮永石大道 / YONGSHI BOULEVARD SHIWAN TOWN BOLUO COUNTY HUIZHOU CITY GUANG DONG)

### 聚氯乙稀物質判定分析流程圖 /

### Analysis flow chart for determination of PVC in material

- 測試人員：林建宇 / Name of the person who made measurement: Roy Lin
- 測試負責人：張啓興 / Name of the person in charge of measurement: Troy Chang

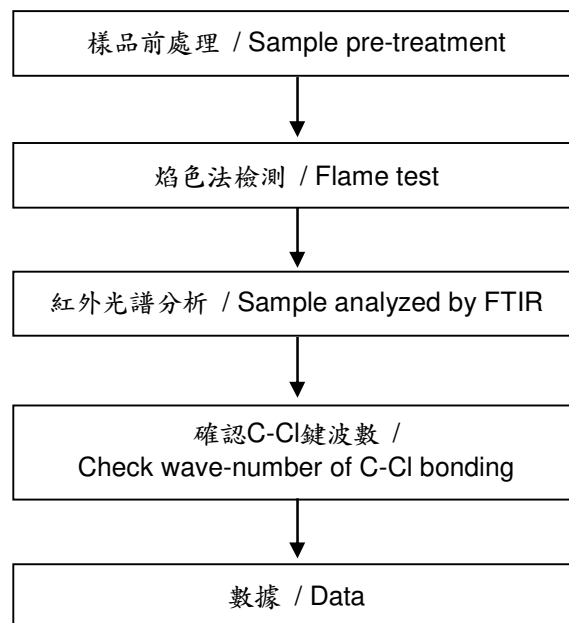



## 測試報告

## Test Report

號碼(No.) : CE/2015/20344

日期(Date) : 2015/02/16

頁數(Page): 59 of 65



南亞塑膠工業股份有限公司(台灣) / NAN YA PLASTICS CORPORATION (TAIWAN)

(南亞電子材料(昆山)有限公司) / NAN YA ELECTRONIC MATERIALS (KUNSHAN) CORP., LTD)

(南亞電子材料(惠州)有限公司) / NAN YA ELECTRONIC MATERIALS (HUIZHOU) CORP., LTD)

台灣台北市敦化北路201號 / 201 TUNG HWA NORTH ROAD, TAIPEI, TAIWAN

(江蘇省昆山昆山市長江南路201號 / 201 CHANG JIANG ROAD(S) KUNSHAN ECONOMIC & TECHNICAL DEVELOPMENT ZONE, JIANG SU)

(廣東省惠州市博羅縣石灣鎮永石大道 / YONGSHI BOULEVARD SHIWAN TOWN BOLUO COUNTY HUIZHOU CITY GUANG DONG)

### 甲醛分析流程圖 / Formaldehyde analytical flow chart

- 測試人員：涂雅苓 / Name of the person who made measurement: Yaling Tu
- 測試負責人：張啓興 / Name of the person in charge of measurement: Troy Chang

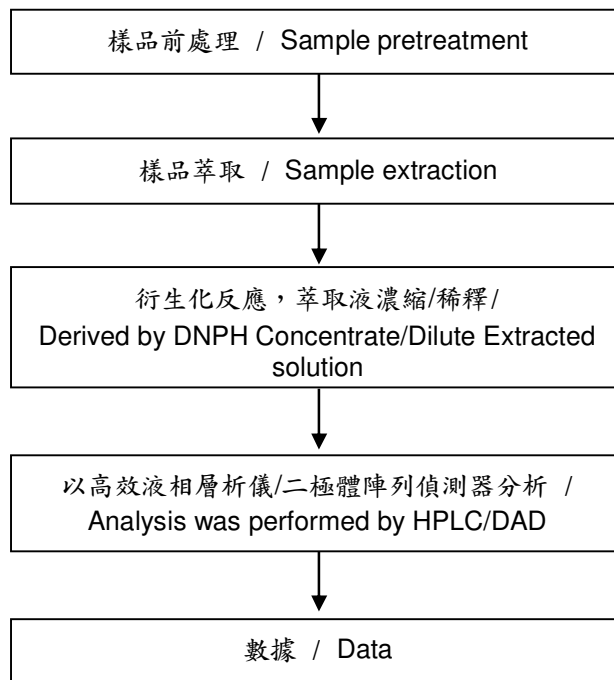

## 測試報告

## Test Report

號碼(No.) : CE/2015/20344

日期(Date) : 2015/02/16

頁數(Page): 60 of 65



南亞塑膠工業股份有限公司(台灣) / NAN YA PLASTICS CORPORATION (TAIWAN)

(南亞電子材料(昆山)有限公司 / NAN YA ELECTRONIC MATERIALS (KUNSHAN) CORP., LTD)

(南亞電子材料(惠州)有限公司 / NAN YA ELECTRONIC MATERIALS (HUIZHOU) CORP., LTD)

台灣台北市敦化北路201號 / 201 TUNG HWA NORTH ROAD, TAIPEI, TAIWAN

(江蘇省昆山昆山市長江南路201號 / 201 CHANG JIANG ROAD(S) KUNSHAN ECONOMIC & TECHNICAL DEVELOPMENT ZONE, JIANG SU)

(廣東省惠州市博羅縣石灣鎮永石大道 / YONGSHI BOULEVARD SHIWAN TOWN BOLUO COUNTY HUIZHOU CITY GUANG DONG)

### 氯化石蠟分析流程圖 / Chlorinated Paraffins analytical flow chart

- 測試人員：曾勃鈞 / Name of the person who made measurement: Barry Tseng
- 測試負責人：張啓興 / Name of the person in charge of measurement: Troy Chang

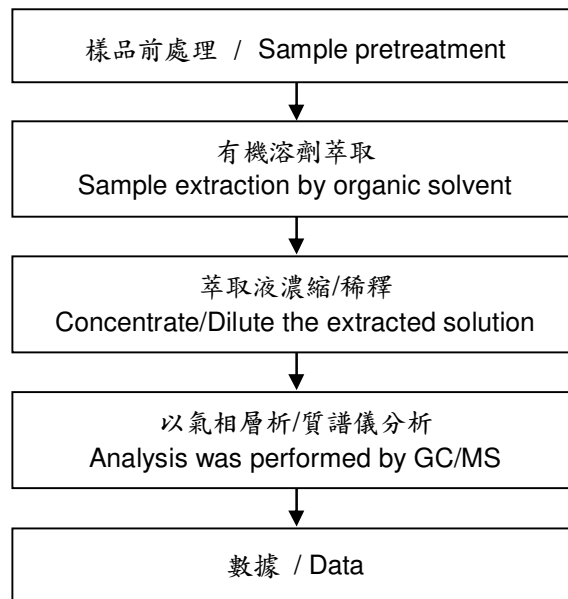

## 測試報告

## Test Report

號碼(No.) : CE/2015/20344

日期(Date) : 2015/02/16

頁數(Page): 61 of 65



南亞塑膠工業股份有限公司(台灣) / NAN YA PLASTICS CORPORATION (TAIWAN)

(南亞電子材料(昆山)有限公司 / NAN YA ELECTRONIC MATERIALS (KUNSHAN) CORP., LTD)

(南亞電子材料(惠州)有限公司 / NAN YA ELECTRONIC MATERIALS (HUIZHOU) CORP., LTD)

台灣台北市敦化北路201號 / 201 TUNG HWA NORTH ROAD, TAIPEI, TAIWAN

(江蘇省昆山昆山市長江南路201號 / 201 CHANG JIANG ROAD(S) KUNSHAN ECONOMIC & TECHNICAL DEVELOPMENT ZONE, JIANG SU)

(廣東省惠州市博羅縣石灣鎮永石大道 / YONGSHI BOULEVARD SHIWAN TOWN BOLUO COUNTY HUIZHOU CITY GUANG DONG)

### 多氯三聯苯分析流程圖 / PCTs analytical flow chart

- 測試人員：曾勃鈞 / Name of the person who made measurement: Barry Tseng
- 測試負責人：張啓興 / Name of the person in charge of measurement: Troy Chang

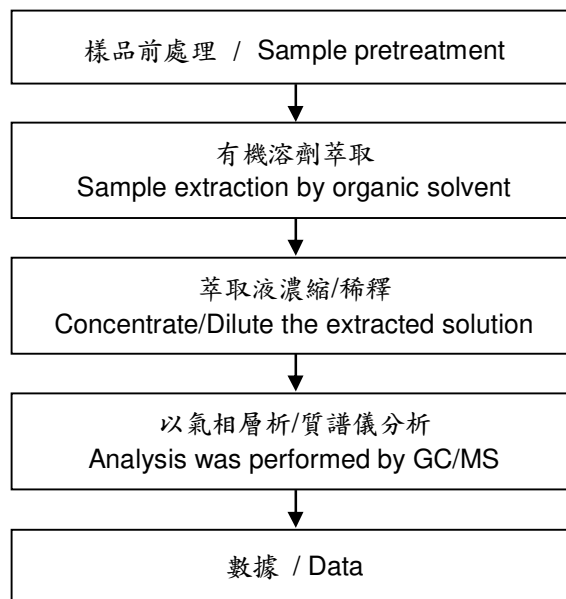

## 測試報告

## Test Report

號碼(No.) : CE/2015/20344

日期(Date) : 2015/02/16

頁數(Page): 62 of 65



南亞塑膠工業股份有限公司(台灣) / NAN YA PLASTICS CORPORATION (TAIWAN)

(南亞電子材料(昆山)有限公司 / NAN YA ELECTRONIC MATERIALS (KUNSHAN) CORP., LTD)

(南亞電子材料(惠州)有限公司 / NAN YA ELECTRONIC MATERIALS (HUIZHOU) CORP., LTD)

台灣台北市敦化北路201號 / 201 TUNG HWA NORTH ROAD, TAIPEI, TAIWAN

(江蘇省昆山昆山市長江南路201號 / 201 CHANG JIANG ROAD(S) KUNSHAN ECONOMIC & TECHNICAL DEVELOPMENT ZONE, JIANG SU)

(廣東省惠州市博羅縣石灣鎮永石大道 / YONGSHI BOULEVARD SHIWAN TOWN BOLUO COUNTY HUIZHOU CITY GUANG DONG)

### 多氯奈分析流程圖 / PCNs analytical flow chart

- 測試人員：曾勃鈞 / Name of the person who made measurement: Barry Tseng
- 測試負責人：張啓興 / Name of the person in charge of measurement: Troy Chang

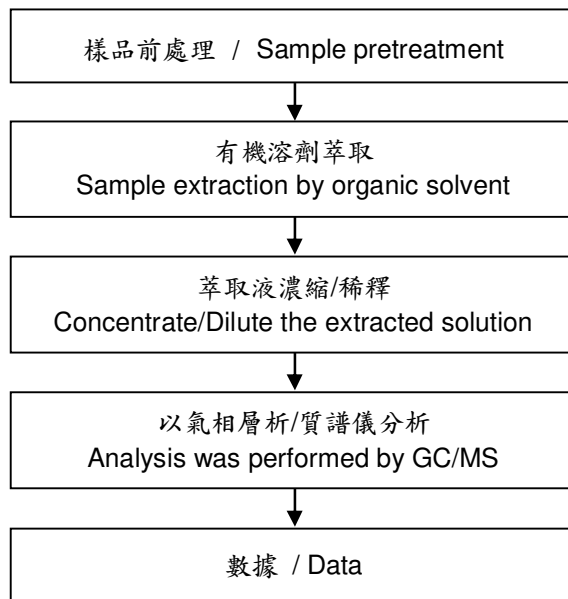

## 測試報告

## Test Report

號碼(No.) : CE/2015/20344

日期(Date) : 2015/02/16

頁數(Page): 63 of 65



南亞塑膠工業股份有限公司(台灣) / NAN YA PLASTICS CORPORATION (TAIWAN)

(南亞電子材料(昆山)有限公司 / NAN YA ELECTRONIC MATERIALS (KUNSHAN) CORP., LTD)

(南亞電子材料(惠州)有限公司 / NAN YA ELECTRONIC MATERIALS (HUIZHOU) CORP., LTD)

台灣台北市敦化北路201號 / 201 TUNG HWA NORTH ROAD, TAIPEI, TAIWAN

(江蘇省昆山昆山市長江南路201號 / 201 CHANG JIANG ROAD(S) KUNSHAN ECONOMIC & TECHNICAL DEVELOPMENT ZONE, JIANG SU)

(廣東省惠州市博羅縣石灣鎮永石大道 / YONGSHI BOULEVARD SHIWAN TOWN BOLUO COUNTY HUIZHOU CITY GUANG DONG)

### 多氣聯苯分析流程圖 / PCBs analytical flow chart

- 測試人員：曾勃鈞 / Name of the person who made measurement: Barry Tseng
- 測試負責人：張啓興 / Name of the person in charge of measurement: Troy Chang

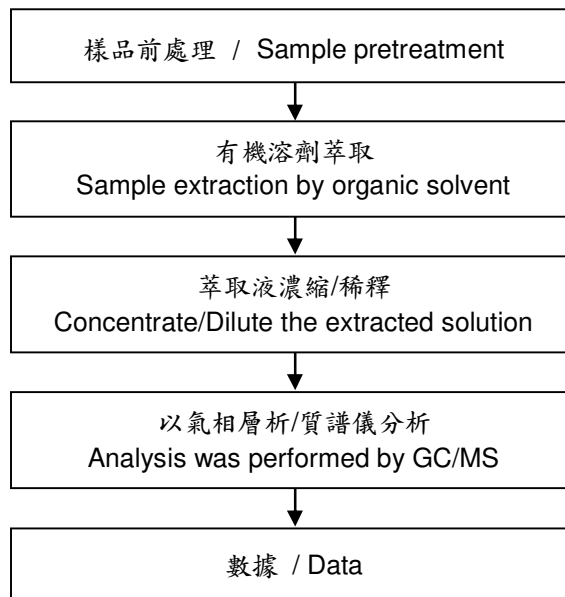

## 測試報告

## Test Report

號碼(No.) : CE/2015/20344

日期(Date) : 2015/02/16

頁數(Page): 64 of 65



南亞塑膠工業股份有限公司(台灣) / NAN YA PLASTICS CORPORATION (TAIWAN)

(南亞電子材料(昆山)有限公司 / NAN YA ELECTRONIC MATERIALS (KUNSHAN) CORP., LTD)

(南亞電子材料(惠州)有限公司 / NAN YA ELECTRONIC MATERIALS (HUIZHOU) CORP., LTD)

台灣台北市敦化北路201號 / 201 TUNG HWA NORTH ROAD, TAIPEI, TAIWAN

(江蘇省昆山昆山市長江南路201號 / 201 CHANG JIANG ROAD(S) KUNSHAN ECONOMIC & TECHNICAL DEVELOPMENT ZONE, JIANG SU)

(廣東省惠州市博羅縣石灣鎮永石大道 / YONGSHI BOULEVARD SHIWAN TOWN BOLUO COUNTY HUIZHOU CITY GUANG DONG)

### 多溴聯苯/多溴聯苯醚分析流程圖 / PBB/PBDE analytical FLOW CHART

- 測試人員：翁賜彬 / Name of the person who made measurement: Roman Wong
  - 測試負責人：張啓興 / Name of the person in charge of measurement: Troy Chang
- 初次測試程序 / First testing process —————▶
- 選擇性篩檢程序 / Optional screen process .....▶
- 確認程序 / Confirmation process - - - ▶

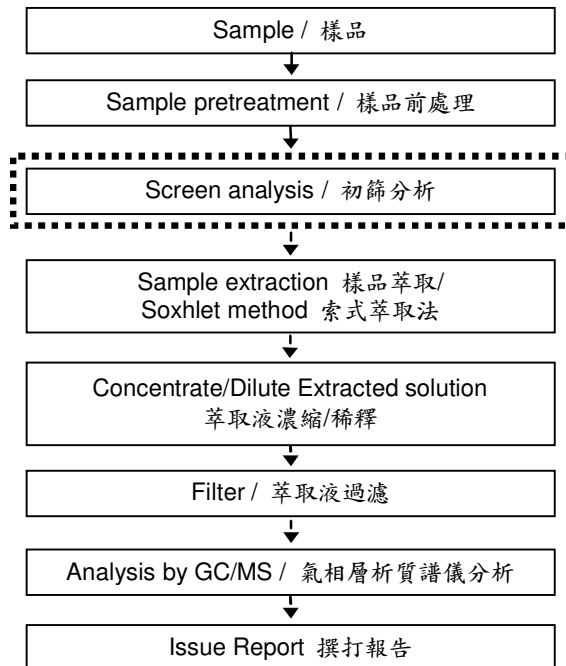

This document is issued by the Company subject to its General Conditions of Service printed overleaf, available on request or accessible at <http://www.sgs.com/en/Terms-and-Conditions.aspx> and, for electronic format documents, subject to Terms and Conditions for Electronic Documents at <http://www.sgs.com/en/Terms-and-Conditions/Termse-Document.aspx>. Attention is drawn to the limitation of liability, indemnification and jurisdiction issues defined therein. Any holder of this document is advised that information contained hereon reflects the Company's findings at the time of its intervention only and within the limits of client's instruction, if any. The Company's sole responsibility is to its Client and this document does not exonerate parties to a transaction from exercising all their rights and obligations under the transaction documents. This document cannot be reproduced, except in full, without prior written approval of the Company. Any unauthorized alteration, forgery or falsification of the content or appearance of this document is unlawful and offenders may be prosecuted to the fullest extent of the law. Unless otherwise stated the results shown in this test report refer only to the sample(s) tested.



## 測試報告

## Test Report

號碼(No.) : CE/2015/20344

日期(Date) : 2015/02/16

頁數(Page): 65 of 65



南亞塑膠工業股份有限公司(台灣) / NAN YA PLASTICS CORPORATION (TAIWAN)

(南亞電子材料(昆山)有限公司 / NAN YA ELECTRONIC MATERIALS (KUNSHAN) CORP., LTD)

(南亞電子材料(惠州)有限公司 / NAN YA ELECTRONIC MATERIALS (HUIZHOU) CORP., LTD)

台灣台北市敦化北路201號 / 201 TUNG HWA NORTH ROAD, TAIPEI, TAIWAN

(江蘇省昆山昆山市長江南路201號 / 201 CHANG JIANG ROAD(S) KUNSHAN ECONOMIC & TECHNICAL DEVELOPMENT ZONE, JIANG SU)

(廣東省惠州市博羅縣石灣鎮永石大道 / YONGSHI BOULEVARD SHIWAN TOWN BOLUO COUNTY HUIZHOU CITY GUANG DONG)

\* 照片中如有箭頭標示，則表示為實際檢測之樣品/部位。\*

(The tested sample / part is marked by an arrow if it's shown on the photo.)

### CE/2015/20344

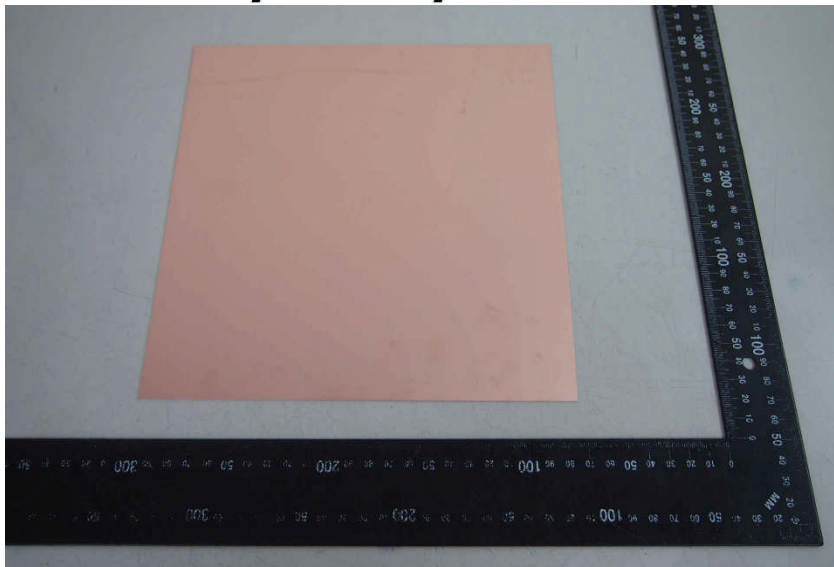

\*\* 報告結尾 (End of Report) \*\*

## Test Report

No. : CE/2014/34748

Date : 2014/03/27

Page : 1 of 7

TAIWAN TAIYO INK CO., LTD.  
NO. 7 TA TUNG SECOND RD. KUAN-YIN INDUSTRY PARK TAOYUAN  
TAIWAN 328, R. O. C.



**The following sample(s) was/were submitted and identified by/on behalf of the applicant as :**

Sample Submitted By : TAIWAN TAIYO INK CO., LTD.  
Sample Description : PHOTOIMAGEABLE SOLDER MASK  
Style/Item No. : PSR-2000 LF02/CA-25 LF01  
UL:PSR-2000BK/CA-25BK  
Color : GREEN  
Sample Receiving Date : 2014/03/20  
Testing Period : 2014/03/20 TO 2014/03/27

**Test Requested** : (1) As specified by client, with reference to RoHS Directive 2011/65/EU Annex II to determine Cadmium, Lead, Mercury, Cr(VI), PBBs, PBDEs contents in the submitted sample.  
(2) As specified by client, to test PFOA, PFOS contents in the submitted sample.

**Test Method** : Please refer to next page(s).

**Test Result(s)** : Please refer to next page(s).

**Conclusion** : (1) Based on the performed tests on submitted samples, the test results of Cadmium, Lead, Mercury, Cr(VI), PBBs, PBDEs comply with the limits as set by RoHS Directive 2011/65/EU Annex II; recasting 2002/95/EC.

  
  
**Troy Chang, Manager - Tech**  
**Signed for and on behalf of**  
**SGS TAIWAN LTD.**  
**Chemical Laboratory - Taipei**

This document is issued by the Company subject to its General Conditions of Service printed overleaf, available on request or accessible at <http://www.sgs.com/en/Terms-and-Conditions.aspx> and, for electronic format documents, subject to Terms and Conditions for Electronic Documents at <http://www.sgs.com/en/Terms-and-Conditions/Termse-Document.aspx>. Attention is drawn to the limitation of liability, indemnification and jurisdiction issues defined therein. Any holder of this document is advised that information contained hereon reflects the Company's findings at the time of its intervention only and within the limits of client's instruction, if any. The Company's sole responsibility is to its Client and this document does not exonerate parties to a transaction from exercising all their rights and obligations under the transaction documents. This document cannot be reproduced, except in full, without prior written approval of the Company. Any unauthorized alteration, forgery or falsification of the content or appearance of this document is unlawful and offenders may be prosecuted to the fullest extent of the law. Unless otherwise stated the results shown in this test report refer only to the sample(s) tested.

# Test Report

No. : CE/2014/34748

Date : 2014/03/27

Page : 2 of 7

TAIWAN TAIYO INK CO., LTD.  
NO. 7 TA TUNG SECOND RD. KUAN-YIN INDUSTRY PARK TAOYUAN  
TAIWAN 328, R. O. C.



## Test Result(s)

PART NAME No.1 : GREEN INK

Test Item(s)	Unit	Method	MDL	Result	Limit
				No.1	
Cadmium (Cd)	mg/kg	With reference to IEC 62321-5: 2013 and performed by ICP-AES.	2	n.d.	100
Lead (Pb)	mg/kg	With reference to IEC 62321-5: 2013 and performed by ICP-AES.	2	n.d.	1000
Mercury (Hg)	mg/kg	With reference to IEC 62321-4: 2013 and performed by ICP-AES.	2	n.d.	1000
Hexavalent Chromium Cr(VI)	mg/kg	With reference to IEC 62321: 2008 and performed by UV-VIS.	2	n.d.	1000
Perfluorooctane sulfonates (PFOS-Acid, Metal Salt, Amide)	mg/kg	With reference to US EPA 3550C: 2007. Analysis was performed by LC/MS.	10	n.d.	-
PFOA (CAS No.: 335-67-1)	mg/kg	With reference to US EPA 3550C: 2007. Analysis was performed by LC/MS.	10	n.d.	-
<b>Sum of PBBs</b>			-	n.d.	1000
Monobromobiphenyl	mg/kg	With reference to IEC 62321: 2008 and performed by GC/MS.	5	n.d.	-
Dibromobiphenyl			5	n.d.	-
Tribromobiphenyl			5	n.d.	-
Tetrabromobiphenyl			5	n.d.	-
Pentabromobiphenyl			5	n.d.	-
Hexabromobiphenyl			5	n.d.	-
Heptabromobiphenyl			5	n.d.	-
Octabromobiphenyl			5	n.d.	-
Nonabromobiphenyl			5	n.d.	-
Decabromobiphenyl			5	n.d.	-

This document is issued by the Company subject to its General Conditions of Service printed overleaf, available on request or accessible at <http://www.sgs.com/en/Terms-and-Conditions.aspx> and, for electronic format documents, subject to Terms and Conditions for Electronic Documents at <http://www.sgs.com/en/Terms-and-Conditions/Termse-Documents.aspx>. Attention is drawn to the limitation of liability, indemnification and jurisdiction issues defined therein. Any holder of this document is advised that information contained hereon reflects the Company's findings at the time of its intervention only and within the limits of client's instruction, if any. The Company's sole responsibility is to its Client and this document does not exonerate parties to a transaction from exercising all their rights and obligations under the transaction documents. This document cannot be reproduced, except in full, without prior written approval of the Company. Any unauthorized alteration, forgery or falsification of the content or appearance of this document is unlawful and offenders may be prosecuted to the fullest extent of the law. Unless otherwise stated the results shown in this test report refer only to the sample(s) tested.

# Test Report

No. : CE/2014/34748

Date : 2014/03/27

Page : 3 of 7

TAIWAN TAIYO INK CO., LTD.  
 NO. 7 TA TUNG SECOND RD. KUAN-YIN INDUSTRY PARK TAOYUAN  
 TAIWAN 328, R. O. C.



Test Item(s)	Unit	Method	MDL	Result	Limit
				No.1	
<b>Sum of PBDEs</b>	mg/kg	With reference to IEC 62321: 2008 and performed by GC/MS.	-	n.d.	1000
Monobromodiphenyl ether			5	n.d.	-
Dibromodiphenyl ether			5	n.d.	-
Tribromodiphenyl ether			5	n.d.	-
Tetrabromodiphenyl ether			5	n.d.	-
Pentabromodiphenyl ether			5	n.d.	-
Hexabromodiphenyl ether			5	n.d.	-
Heptabromodiphenyl ether			5	n.d.	-
Octabromodiphenyl ether			5	n.d.	-
Nonabromodiphenyl ether			5	n.d.	-
Decabromodiphenyl ether			5	n.d.	-

**Note :**

1. mg/kg = ppm; 0.1wt% = 1000ppm
2. n.d. = Not Detected
3. MDL = Method Detection Limit
4. " - " = Not Regulated

**PFOS Reference Information : POPs - (EU) 757/2010**

Outlawing PFOS as substances or preparations in concentrations above 0.001% (10ppm), in semi-finished products or articles or parts at a level above 0.1%(1000ppm), in textiles or other coated materials above 1µg/m<sup>2</sup>.

This document is issued by the Company subject to its General Conditions of Service printed overleaf, available on request or accessible at <http://www.sgs.com/en/Terms-and-Conditions.aspx> and, for electronic format documents, subject to Terms and Conditions for Electronic Documents at <http://www.sgs.com/en/Terms-and-Conditions/Termse-Documents.aspx>. Attention is drawn to the limitation of liability, indemnification and jurisdiction issues defined therein. Any holder of this document is advised that information contained hereon reflects the Company's findings at the time of its intervention only and within the limits of client's instruction, if any. The Company's sole responsibility is to its Client and this document does not exonerate parties to a transaction from exercising all their rights and obligations under the transaction documents. This document cannot be reproduced, except in full, without prior written approval of the Company. Any unauthorized alteration, forgery or falsification of the content or appearance of this document is unlawful and offenders may be prosecuted to the fullest extent of the law. Unless otherwise stated the results shown in this test report refer only to the sample(s) tested.

## Test Report

No. : CE/2014/34748

Date : 2014/03/27

Page : 4 of 7

TAIWAN TAIYO INK CO., LTD.  
NO. 7 TA TUNG SECOND RD. KUAN-YIN INDUSTRY PARK TAOYUAN  
TAIWAN 328, R. O. C.



- 1) These samples were dissolved totally by pre-conditioning method according to below flow chart.  
(Cr<sup>6+</sup> test method excluded)
- 2) Name of the person who made measurement: Climbgreat Yang
- 3) Name of the person in charge of measurement: Troy Chang

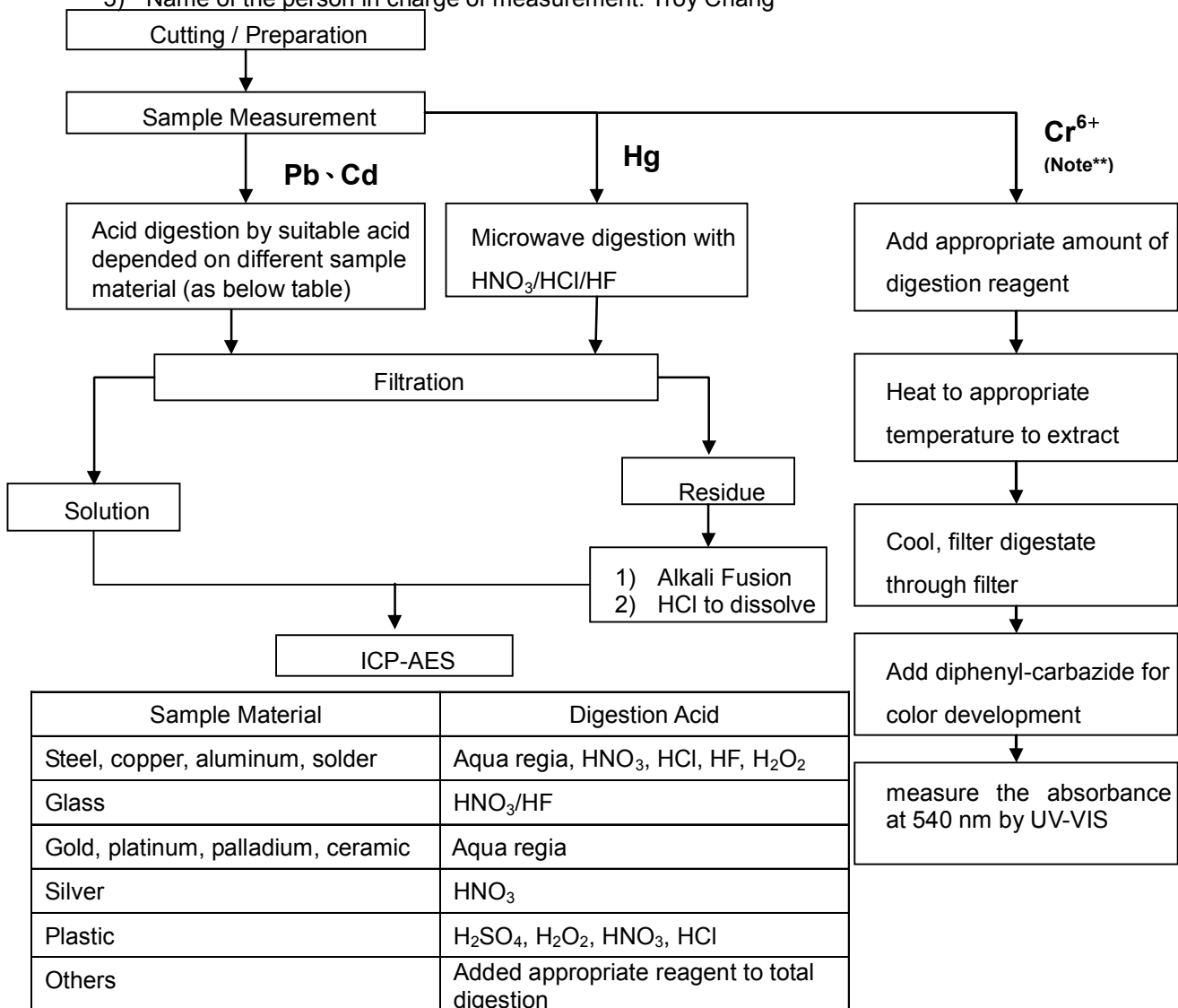

**Note\*\* :** (1) For non-metallic material, add alkaline digestion reagent and heat to 90~95 °C.  
(2) For metallic material, add pure water and heat to boiling.

TAIWAN TAIYO INK CO., LTD.  
 NO. 7 TA TUNG SECOND RD. KUAN-YIN INDUSTRY PARK TAOYUAN  
 TAIWAN 328, R. O. C.



### PFOA/PFOS analytical flow chart of Ultrasonic extraction (LC/MS) procedure

- Name of the person who made measurement: Roman Wong
- Name of the person in charge of measurement: Troy Chang

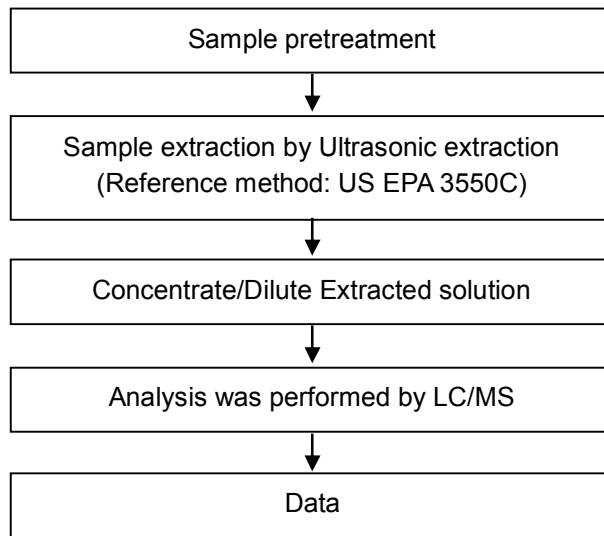

This document is issued by the Company subject to its General Conditions of Service printed overleaf, available on request or accessible at <http://www.sgs.com/en/Terms-and-Conditions.aspx> and, for electronic format documents, subject to Terms and Conditions for Electronic Documents at <http://www.sgs.com/en/Terms-and-Conditions/Termse-Document.aspx>. Attention is drawn to the limitation of liability, indemnification and jurisdiction issues defined therein. Any holder of this document is advised that information contained hereon reflects the Company's findings at the time of its intervention only and within the limits of client's instruction, if any. The Company's sole responsibility is to its Client and this document does not exonerate parties to a transaction from exercising all their rights and obligations under the transaction documents. This document cannot be reproduced, except in full, without prior written approval of the Company. Any unauthorized alteration, forgery or falsification of the content or appearance of this document is unlawful and offenders may be prosecuted to the fullest extent of the law. Unless otherwise stated the results shown in this test report refer only to the sample(s) tested.



TAIWAN TAIYO INK CO., LTD.  
 NO. 7 TA TUNG SECOND RD. KUAN-YIN INDUSTRY PARK TAOYUAN  
 TAIWAN 328, R. O. C.



### PBB/PBDE analytical FLOW CHART

- Name of the person who made measurement: Roman Wong
- Name of the person in charge of measurement: Troy Chang

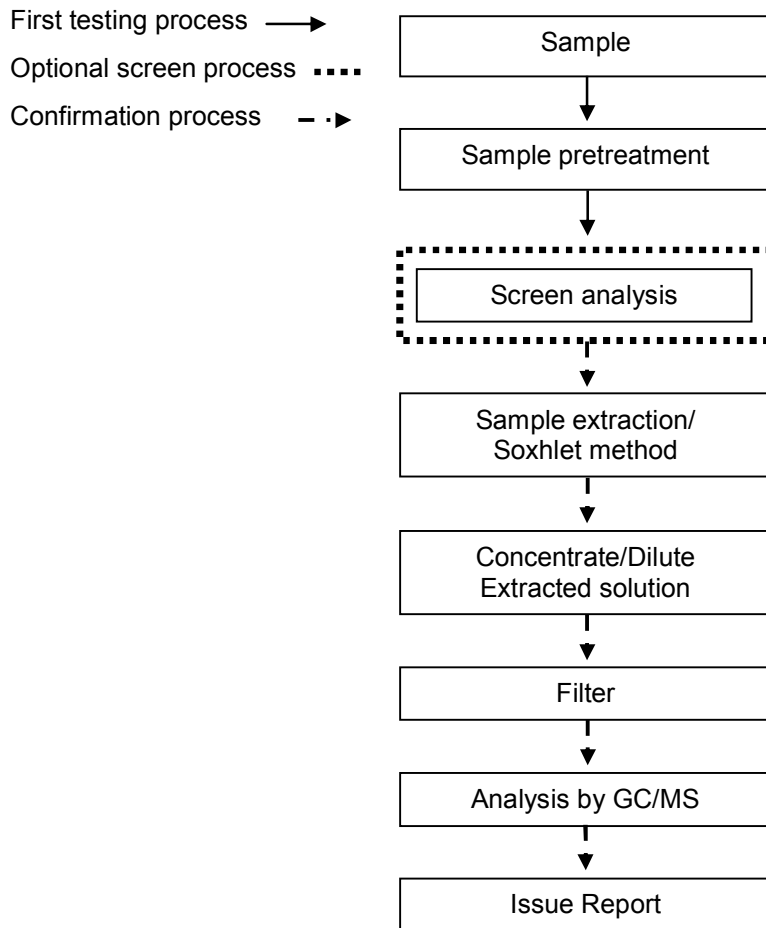

This document is issued by the Company subject to its General Conditions of Service printed overleaf, available on request or accessible at <http://www.sgs.com/en/Terms-and-Conditions.aspx> and, for electronic format documents, subject to Terms and Conditions for Electronic Documents at <http://www.sgs.com/en/Terms-and-Conditions/Termse-Documents.aspx>. Attention is drawn to the limitation of liability, indemnification and jurisdiction issues defined therein. Any holder of this document is advised that information contained hereon reflects the Company's findings at the time of its intervention only and within the limits of client's instruction, if any. The Company's sole responsibility is to its Client and this document does not exonerate parties to a transaction from exercising all their rights and obligations under the transaction documents. This document cannot be reproduced, except in full, without prior written approval of the Company. Any unauthorized alteration, forgery or falsification of the content or appearance of this document is unlawful and offenders may be prosecuted to the fullest extent of the law. Unless otherwise stated the results shown in this test report refer only to the sample(s) tested.

## Test Report

No. : CE/2014/34748

Date : 2014/03/27

Page : 7 of 7

TAIWAN TAIYO INK CO., LTD.  
NO. 7 TA TUNG SECOND RD. KUAN-YIN INDUSTRY PARK TAOYUAN  
TAIWAN 328, R. O. C.



\* The tested sample / part is marked by an arrow if it's shown on the photo. \*

### CE/2014/34748



\*\* End of Report \*\*

This document is issued by the Company subject to its General Conditions of Service printed overleaf, available on request or accessible at <http://www.sgs.com/en/Terms-and-Conditions.aspx> and, for electronic format documents, subject to Terms and Conditions for Electronic Documents at <http://www.sgs.com/en/Terms-and-Conditions/Termse-Document.aspx>. Attention is drawn to the limitation of liability, indemnification and jurisdiction issues defined therein. Any holder of this document is advised that information contained hereon reflects the Company's findings at the time of its intervention only and within the limits of client's instruction, if any. The Company's sole responsibility is to its Client and this document does not exonerate parties to a transaction from exercising all their rights and obligations under the transaction documents. This document cannot be reproduced, except in full, without prior written approval of the Company. Any unauthorized alteration, forgery or falsification of the content or appearance of this document is unlawful and offenders may be prosecuted to the fullest extent of the law. Unless otherwise stated the results shown in this test report refer only to the sample(s) tested.

## 測試報告

## Test Report

號碼(No.) : CE/2014/20824A 日期(Date) : 2014/02/14 頁數(Page) : 1 of 9

柔洋股份有限公司

LA MIEUX PRODUCTS CO., LTD.

新北市汐止區新台五路一段79號4樓之4

4F-4, NO. 79, SEC. 1, HSIN TAI WU RD., HSI-CHIH DIST., NEW TAIPEI CITY 22101, TAIWAN



以下測試樣品係由申請廠商所提供及確認 (The following sample(s) was/were submitted and identified by/on behalf of the applicant as) :

送樣廠商(Sample Submitted By) : 柔洋股份有限公司 (LA MIEUX PRODUCTS CO., LTD.)

樣品名稱(Sample Description) : THERMELT ADHESIVE

樣品型號(Style/Item No.) : THERMELT 867B

收件日期(Sample Receiving Date) : 2014/02/07

測試期間(Testing Period) : 2014/02/07 TO 2014/02/14

=====  
測試結果(Test Results) : 請見下一頁 (Please refer to next pages).

  
Troy Chang, Manager-Tech  
Signed for and on behalf of  
SGS TAIWAN LTD.  
Chemical Laboratory – Taipei

This document is issued by the Company subject to its General Conditions of Service printed overleaf, available on request or accessible at <http://www.sgs.com/en/Terms-and-Conditions.aspx> and, for electronic format documents, subject to Terms and Conditions for Electronic Documents at <http://www.sgs.com/en/Terms-and-Conditions/Termse-Documents.aspx>. Attention is drawn to the limitation of liability, indemnification and jurisdiction issues defined therein. Any holder of this document is advised that information contained hereon reflects the Company's findings at the time of its intervention only and within the limits of client's instruction, if any. The Company's sole responsibility is to its Client and this document does not exonerate parties to a transaction from exercising all their rights and obligations under the transaction documents. This document cannot be reproduced, except in full, without prior written approval of the Company. Any unauthorized alteration, forgery or falsification of the content or appearance of this document is unlawful and offenders may be prosecuted to the fullest extent of the law. Unless otherwise stated the results shown in this test report refer only to the sample(s) tested.

# 測試報告

## Test Report

號碼(No.) : CE/2014/20824A 日期(Date) : 2014/02/14 頁數(Page) : 2 of 9

柔洋股份有限公司

LA MIEUX PRODUCTS CO., LTD.

新北市汐止區新台五路一段79號4樓之4

4F-4, NO. 79, SEC. 1, HSIN TAI WU RD., HSI-CHIH DIST., NEW TAIPEI CITY 22101, TAIWAN



### 測試結果(Test Results)

測試部位(PART NAME)No.1 : 黑色塑膠粒 (BLACK PLASTIC PELLETS)

測試項目 (Test Items)	單位 (Unit)	測試方法 (Method)	方法偵測 極限值 (MDL)	結果 (Result)
				No.1
鎘 / Cadmium (Cd)	mg/kg	參考IEC 62321-5: 2013方法, 以感應耦合電漿原子發射光譜儀檢測. / With reference to IEC 62321-5: 2013 and performed by ICP-AES.	2	n.d.
鉛 / Lead (Pb)	mg/kg	參考IEC 62321-5: 2013方法, 以感應耦合電漿原子發射光譜儀檢測. / With reference to IEC 62321-5: 2013 and performed by ICP-AES.	2	n.d.
汞 / Mercury (Hg)	mg/kg	參考IEC 62321-4: 2013方法, 以感應耦合電漿原子發射光譜儀檢測. / With reference to IEC 62321-4: 2013 and performed by ICP-AES.	2	n.d.
六價鉻 / Hexavalent Chromium Cr(VI)	mg/kg	參考IEC 62321: 2008方法, 以UV-VIS檢測. / With reference to IEC 62321: 2008 and performed by UV-VIS.	2	n.d.
六溴環十二烷及所有主要被辨別出的異構物 / Hexabromocyclododecane (HBCDD) and all major diastereoisomers identified ( $\alpha$ -HBCDD, $\beta$ -HBCDD, $\gamma$ -HBCDD) (CAS No.: 25637-99-4 and 3194-55-6 (134237-51-7, 134237-50-6, 134237-52-8))	mg/kg	參考IEC 62321: 2008方法, 以氣相層析/質譜儀檢測. / With reference to IEC 62321: 2008 method. Analysis was performed by GC/MS.	5	n.d.
鄰苯二甲酸甲苄基丁酯 / BBP (Benzyl butyl phthalate) (CAS No.: 85-68-7)	%	參考EN 14372, 以氣相層析/質譜儀檢測之. / With reference to EN 14372. Analysis was performed by GC/MS.	0.003	n.d.

This document is issued by the Company subject to its General Conditions of Service printed overleaf, available on request or accessible at <http://www.sgs.com/en/Terms-and-Conditions.aspx> and, for electronic format documents, subject to Terms and Conditions for Electronic Documents at <http://www.sgs.com/en/Terms-and-Conditions/Termse-Documents.aspx>. Attention is drawn to the limitation of liability, indemnification and jurisdiction issues defined therein. Any holder of this document is advised that information contained hereon reflects the Company's findings at the time of its intervention only and within the limits of client's instruction, if any. The Company's sole responsibility is to its Client and this document does not exonerate parties to a transaction from exercising all their rights and obligations under the transaction documents. This document cannot be reproduced, except in full, without prior written approval of the Company. Any unauthorized alteration, forgery or falsification of the content or appearance of this document is unlawful and offenders may be prosecuted to the fullest extent of the law. Unless otherwise stated the results shown in this test report refer only to the sample(s) tested.

# 測試報告

## Test Report

號碼(No.) : CE/2014/20824A 日期(Date) : 2014/02/14 頁數(Page) : 3 of 9

柔洋股份有限公司



LA MIEUX PRODUCTS CO., LTD.

新北市汐止區新台五路一段79號4樓之4

4F-4, NO. 79, SEC. 1, HSIN TAI WU RD., HSI-CHIH DIST., NEW TAIPEI CITY 22101, TAIWAN

測試項目 (Test Items)	單位 (Unit)	測試方法 (Method)	方法偵測 極限值 (MDL)	結果 (Result)
				No.1
鄰苯二甲酸二(2-乙基己基)酯 / DEHP (Di-(2-ethylhexyl) phthalate) (CAS No.: 117-81-7)	%	參考EN 14372, 以氣相層析/質譜儀檢測之。 / With reference to EN 14372. Analysis was performed by GC/MS.	0.003	n.d.
鄰苯二甲酸二異癸酯 / DIDP (Di-isodecyl phthalate) (CAS No.: 26761-40-0; 68515-49-1)	%	參考EN 14372, 以氣相層析/質譜儀檢測之。 / With reference to EN 14372. Analysis was performed by GC/MS.	0.01	n.d.
鄰苯二甲酸二異壬酯 / DINP (Di-isononyl phthalate) (CAS No.: 28553-12-0; 68515-48-0)	%	參考EN 14372, 以氣相層析/質譜儀檢測之。 / With reference to EN 14372. Analysis was performed by GC/MS.	0.01	n.d.
鄰苯二甲酸二正辛酯 / DNOP (Di-n-octyl phthalate) (CAS No.: 117-84-0)	%	參考EN 14372, 以氣相層析/質譜儀檢測之。 / With reference to EN 14372. Analysis was performed by GC/MS.	0.003	n.d.
鄰苯二甲酸二丁酯 / DBP (Dibutyl phthalate) (CAS No.: 84-74-2)	%	參考EN 14372, 以氣相層析/質譜儀檢測之。 / With reference to EN 14372. Analysis was performed by GC/MS.	0.003	n.d.
<b>多溴聯苯總和 / Sum of PBBs</b>	mg/kg	參考IEC 62321: 2008方法, 以氣相層析/質譜儀檢測。 / With reference to IEC 62321: 2008 and performed by GC/MS.	-	n.d.
一溴聯苯 / Monobromobiphenyl	mg/kg		5	n.d.
二溴聯苯 / Dibromobiphenyl	mg/kg		5	n.d.
三溴聯苯 / Tribromobiphenyl	mg/kg		5	n.d.
四溴聯苯 / Tetrabromobiphenyl	mg/kg		5	n.d.
五溴聯苯 / Pentabromobiphenyl	mg/kg		5	n.d.
六溴聯苯 / Hexabromobiphenyl	mg/kg		5	n.d.
七溴聯苯 / Heptabromobiphenyl	mg/kg		5	n.d.
八溴聯苯 / Octabromobiphenyl	mg/kg		5	n.d.
九溴聯苯 / Nonabromobiphenyl	mg/kg		5	n.d.
十溴聯苯 / Decabromobiphenyl	mg/kg		5	n.d.

This document is issued by the Company subject to its General Conditions of Service printed overleaf, available on request or accessible at <http://www.sgs.com/en/Terms-and-Conditions.aspx> and, for electronic format documents, subject to Terms and Conditions for Electronic Documents at <http://www.sgs.com/en/Terms-and-Conditions/Termse-Document.aspx>. Attention is drawn to the limitation of liability, indemnification and jurisdiction issues defined therein. Any holder of this document is advised that information contained hereon reflects the Company's findings at the time of its intervention only and within the limits of client's instruction, if any. The Company's sole responsibility is to its Client and this document does not exonerate parties to a transaction from exercising all their rights and obligations under the transaction documents. This document cannot be reproduced, except in full, without prior written approval of the Company. Any unauthorized alteration, forgery or falsification of the content or appearance of this document is unlawful and offenders may be prosecuted to the fullest extent of the law. Unless otherwise stated the results shown in this test report refer only to the sample(s) tested.

# 測試報告

## Test Report

號碼(No.) : CE/2014/20824A 日期(Date) : 2014/02/14 頁數(Page) : 4 of 9

柔洋股份有限公司



LA MIEUX PRODUCTS CO., LTD.

新北市汐止區新台五路一段79號4樓之4

4F-4, NO. 79, SEC. 1, HSIN TAI WU RD., HSI-CHIH DIST., NEW TAIPEI CITY 22101, TAIWAN

測試項目 (Test Items)	單位 (Unit)	測試方法 (Method)	方法偵測 極限值 (MDL)	結果 (Result)
				No.1
多溴聯苯醚總和 / Sum of PBDEs	mg/kg	參考IEC 62321: 2008方法, 以氣相層析/質譜儀檢測. / With reference to IEC 62321: 2008 and performed by GC/MS.	-	n.d.
一溴聯苯醚 / Monobromodiphenyl ether	mg/kg		5	n.d.
二溴聯苯醚 / Dibromodiphenyl ether	mg/kg		5	n.d.
三溴聯苯醚 / Tribromodiphenyl ether	mg/kg		5	n.d.
四溴聯苯醚 / Tetrabromodiphenyl ether	mg/kg		5	n.d.
五溴聯苯醚 / Pentabromodiphenyl ether	mg/kg		5	n.d.
六溴聯苯醚 / Hexabromodiphenyl ether	mg/kg		5	n.d.
七溴聯苯醚 / Heptabromodiphenyl ether	mg/kg		5	n.d.
八溴聯苯醚 / Octabromodiphenyl ether	mg/kg		5	n.d.
九溴聯苯醚 / Nonabromodiphenyl ether	mg/kg		5	n.d.
十溴聯苯醚 / Decabromodiphenyl ether	mg/kg	5	n.d.	

### 備註(Note) :

1. mg/kg = ppm ; 0.1wt% = 1000ppm
2. n.d. = Not Detected (未檢出)
3. MDL = Method Detection Limit (方法偵測極限值)
4. "-" = Not Regulated (無規格值)



## 測試報告

號碼(No.) : CE/2014/20824A 日期(Date) : 2014/02/14 頁數(Page) : 5 of 9

## Test Report

柔洋股份有限公司



LA MIEUX PRODUCTS CO., LTD.

新北市汐止區新台五路一段79號4樓之4

4F-4, NO. 79, SEC. 1, HSIN TAI WU RD., HSI-CHIH DIST., NEW TAIPEI CITY 22101, TAIWAN

- 1) 根據以下的流程圖之條件, 樣品已完全溶解。(六價鉻測試方法除外) / These samples were dissolved totally by pre-conditioning method according to below flow chart. (Cr<sup>6+</sup> test method excluded)
- 2) 測試人員: 楊登偉 / Name of the person who made measurement: Climbgreat Yang
- 3) 測試負責人: 張啓興 / Name of the person in charge of measurement: Troy Chang

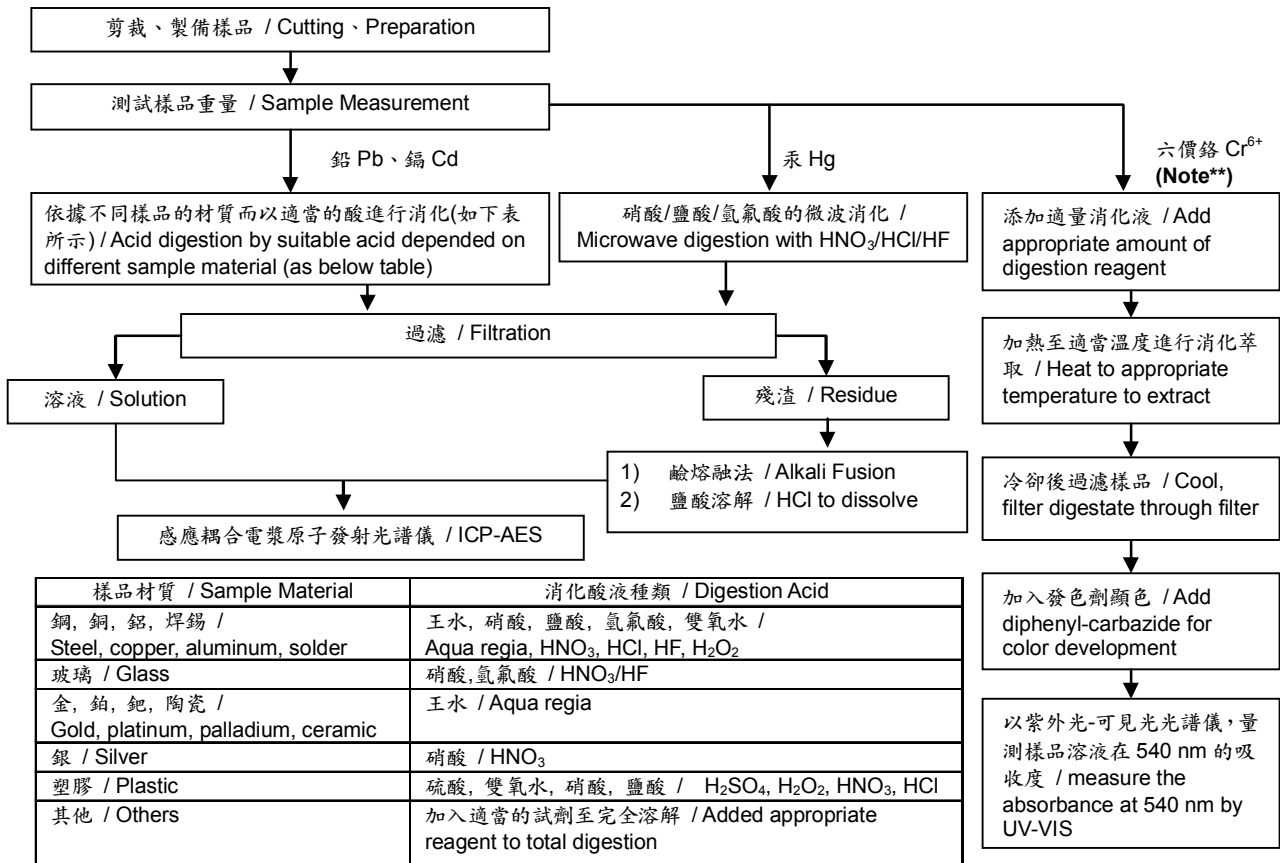

### Note\*\* (For IEC 62321)

- (1) 針對非金屬材料加入鹼性消化液, 加熱至 90~95°C 萃取. / For non-metallic material, add alkaline digestion reagent and heat to 90~95°C.
- (2) 針對金屬材料加入純水, 加熱至沸騰萃取. / For metallic material, add pure water and heat to boiling.

## 測試報告

## Test Report

號碼(No.) : CE/2014/20824A 日期(Date) : 2014/02/14 頁數(Page) : 6 of 9

柔洋股份有限公司

LA MIEUX PRODUCTS CO., LTD.

新北市汐止區新台五路一段79號4樓之4

4F-4, NO. 79, SEC. 1, HSIN TAI WU RD., HSI-CHIH DIST., NEW TAIPEI CITY 22101, TAIWAN



### 可塑劑分析流程圖 / Analytical flow chart of phthalate content

- 測試人員：翁賜彬 / Name of the person who made measurement: Roman Wong
- 測試負責人：張啓興 / Name of the person in charge of measurement: Troy Chang

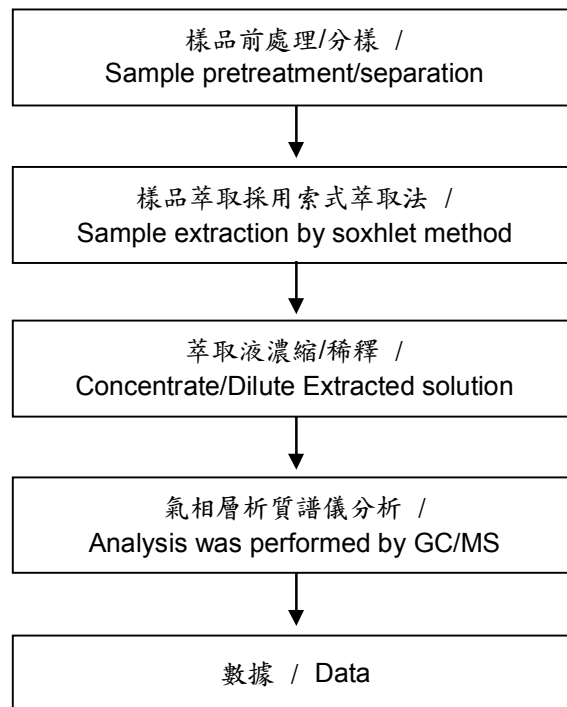

This document is issued by the Company subject to its General Conditions of Service printed overleaf, available on request or accessible at <http://www.sgs.com/en/Terms-and-Conditions.aspx> and, for electronic format documents, subject to Terms and Conditions for Electronic Documents at <http://www.sgs.com/en/Terms-and-Conditions/Termse-Document.aspx>. Attention is drawn to the limitation of liability, indemnification and jurisdiction issues defined therein. Any holder of this document is advised that information contained hereon reflects the Company's findings at the time of its intervention only and within the limits of client's instruction, if any. The Company's sole responsibility is to its Client and this document does not exonerate parties to a transaction from exercising all their rights and obligations under the transaction documents. This document cannot be reproduced, except in full, without prior written approval of the Company. Any unauthorized alteration, forgery or falsification of the content or appearance of this document is unlawful and offenders may be prosecuted to the fullest extent of the law. Unless otherwise stated the results shown in this test report refer only to the sample(s) tested.

## 測試報告

## Test Report

號碼(No.) : CE/2014/20824A 日期(Date) : 2014/02/14 頁數(Page) : 7 of 9

柔洋股份有限公司

LA MIEUX PRODUCTS CO., LTD.

新北市汐止區新台五路一段79號4樓之4

4F-4, NO. 79, SEC. 1, HSIN TAI WU RD., HSI-CHIH DIST., NEW TAIPEI CITY 22101, TAIWAN



### 六溴環十二烷分析流程圖 / HBCDD analytical flow chart

- 測試人員：翁賜彬 / Name of the person who made measurement: Roman Wong
- 測試負責人：張啓興 / Name of the person in charge of measurement: Troy Chang

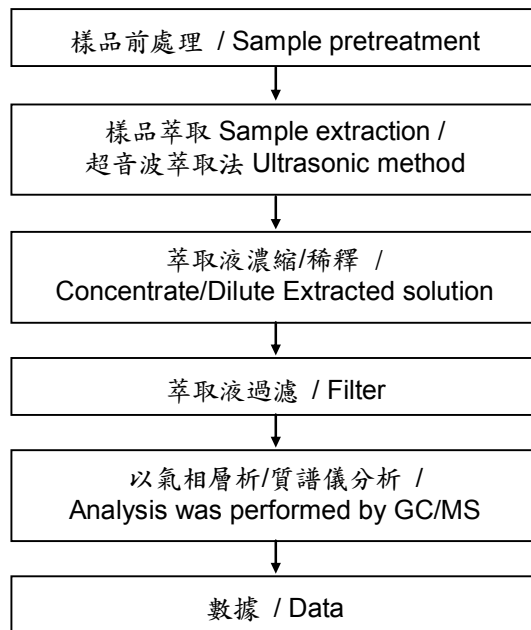

## 測試報告

## Test Report

號碼(No.) : CE/2014/20824A 日期(Date) : 2014/02/14 頁數(Page) : 8 of 9

柔洋股份有限公司

LA MIEUX PRODUCTS CO., LTD.

新北市汐止區新台五路一段79號4樓之4

4F-4, NO. 79, SEC. 1, HSIN TAI WU RD., HSI-CHIH DIST., NEW TAIPEI CITY 22101, TAIWAN



### 多溴聯苯/多溴聯苯醚分析流程圖 / PBB/PBDE analytical FLOW CHART

- 測試人員：翁賜彬 / Name of the person who made measurement: Roman Wong
  - 測試負責人：張啓興 / Name of the person in charge of measurement: Troy Chang
- 初次測試程序 / First testing process —————>
- 選擇性篩檢程序 / Optional screen process .....>
- 確認程序 / Confirmation process - - ->

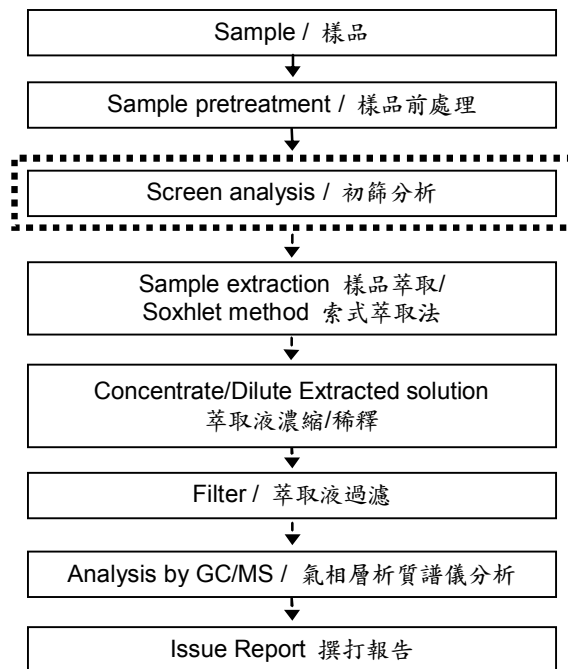

This document is issued by the Company subject to its General Conditions of Service printed overleaf, available on request or accessible at <http://www.sgs.com/en/Terms-and-Conditions.aspx> and, for electronic format documents, subject to Terms and Conditions for Electronic Documents at <http://www.sgs.com/en/Terms-and-Conditions/Termse-Document.aspx>. Attention is drawn to the limitation of liability, indemnification and jurisdiction issues defined therein. Any holder of this document is advised that information contained hereon reflects the Company's findings at the time of its intervention only and within the limits of client's instruction, if any. The Company's sole responsibility is to its Client and this document does not exonerate parties to a transaction from exercising all their rights and obligations under the transaction documents. This document cannot be reproduced, except in full, without prior written approval of the Company. Any unauthorized alteration, forgery or falsification of the content or appearance of this document is unlawful and offenders may be prosecuted to the fullest extent of the law. Unless otherwise stated the results shown in this test report refer only to the sample(s) tested.

## 測試報告

## Test Report

號碼(No.) : CE/2014/20824A 日期(Date) : 2014/02/14 頁數(Page) : 9 of 9

柔洋股份有限公司

LA MIEUX PRODUCTS CO., LTD.

新北市汐止區新台五路一段79號4樓之4

4F-4, NO. 79, SEC. 1, HSIN TAI WU RD., HSI-CHIH DIST., NEW TAIPEI CITY 22101, TAIWAN



\* 照片中如有箭頭標示，則表示為實際檢測之樣品/部位。\*  
(The tested sample / part is marked by an arrow if it's shown on the photo.)

### CE/2014/20824



\*\* 報告結尾 (End of Report) \*\*

## Test Report

No. CANEC1503027705

Date: 16 Mar 2015

Page 1 of 7

DING FENG PLASTICS METAL FACTORY  
CHANG HSIANG VILLAGE, HENGLI TOWN, DONGGUAN CITY, GUANGDONG  
CHINA

The following sample(s) was/were submitted and identified on behalf of the clients as : PVC plastic grains

SGS Job No. : CP15-009381 - SZ  
Client Ref. Info. : PVC Plastic grains  
BLACK/WHITE/GRAY  
Date of Sample Received : 09 Mar 2015  
Testing Period : 09 Mar 2015 - 13 Mar 2015  
Test Requested : Selected test(s) as requested by client.  
Test Method : Please refer to next page(s).  
Test Results : Please refer to next page(s).

Signed for and on behalf of  
SGS-CSTC Standards Technical Services Co., Ltd. Guangzhou Branch



Almay Gao  
Approved Signatory



This document is issued by the Company subject to its General Conditions of Service printed overleaf, available on request or accessible at <http://www.sgs.com/en/Terms-and-Conditions.aspx> and, for electronic format documents, subject to Terms and Conditions for Electronic Documents at <http://www.sgs.com/en/Terms-and-Conditions/Terms-e-Documents.aspx>. Attention is drawn to the limitation of liability, indemnification and jurisdiction issues defined therein. Any holder of this document is advised that information contained hereon reflects the Company's findings at the time of its intervention only and within the limits of Client's instructions, if any. The Company's sole responsibility is to its Client and this document does not exonerate parties to a transaction from exercising all their rights and obligations under the transaction documents. This document cannot be reproduced except in full, without prior written approval of the Company. Any unauthorized alteration, forgery or falsification of the content or appearance of this document is unlawful and offenders may be prosecuted to the fullest extent of the law. Unless otherwise stated the results shown in this test report refer only to the sample(s) tested.

Attention: To check the authenticity of testing /inspection report & certificate, please contact us at telephone: (86-755) 8307 1443, or email: [CN.Doccheck@sgs.com](mailto:CN.Doccheck@sgs.com)

198 Kezhu Road, Sciencetech Park Guangzhou Economic & Technology Development District, Guangzhou, China 510663 t (86-20) 82155555 f (86-20) 82075113 www.sgsgroup.com.cn  
中国·广州·经济技术开发区科学城科珠路198号 邮编: 510663 t (86-20) 82155555 f (86-20) 82075113 e [sgs.china@sgs.com](mailto:sgs.china@sgs.com)



Test Results :

Test Part Description :

Specimen No.	SGS Sample ID	Description
SN1	CAN15-030277.003	Black plastic grains+White plastic grains+Gray plastic grains

Remarks :

- (1) 1 mg/kg = 1 ppm = 0.0001%
- (2) MDL = Method Detection Limit
- (3) ND = Not Detected ( < MDL )
- (4) "-" = Not Regulated

**Elementary Analysis & Flame Retardants**

- Test Method :
- (1)With reference to IEC 62321-5:2013, determination of Cadmium by ICP-OES.
  - (2)With reference to IEC 62321-5:2013, determination of Lead by ICP-OES.
  - (3)With reference to IEC 62321-4:2013, determination of Mercury by ICP-OES.
  - (4)With reference to IEC 62321:2008, determination of Hexavalent Chromium by Colorimetric Method using UV-Vis.
  - (5)With reference to IEC 62321:2008, determination of PBBs and PBDEs by GC-MS.

<u>Test Item(s)</u>	<u>Unit</u>	<u>MDL</u>	<u>003</u>
Cadmium (Cd)	mg/kg	2	ND
Lead (Pb)	mg/kg	2	ND
Mercury (Hg)	mg/kg	2	ND
Hexavalent Chromium (CrVI)	mg/kg	2	ND
Sum of PBBs	mg/kg	-	ND
Monobromobiphenyl	mg/kg	5	ND
Dibromobiphenyl	mg/kg	5	ND
Tribromobiphenyl	mg/kg	5	ND
Tetrabromobiphenyl	mg/kg	5	ND
Pentabromobiphenyl	mg/kg	5	ND
Hexabromobiphenyl	mg/kg	5	ND
Heptabromobiphenyl	mg/kg	5	ND
Octabromobiphenyl	mg/kg	5	ND
Nonabromobiphenyl	mg/kg	5	ND
Decabromobiphenyl	mg/kg	5	ND
Sum of PBDEs	mg/kg	-	ND
Monobromodiphenyl ether	mg/kg	5	ND



This document is issued by the Company subject to its General Conditions of Service printed overleaf, available on request or accessible at <http://www.sgs.com/en/Terms-and-Conditions.aspx> and, for electronic format documents, subject to Terms and Conditions for Electronic Documents at <http://www.sgs.com/en/Terms-and-Conditions/Terms-e-Documents.aspx>. Attention is drawn to the limitation of liability, indemnification and jurisdiction issues defined therein. Any holder of this document is advised that information contained hereon reflects the Company's findings at the time of its intervention only and within the limits of Client's instructions, if any. The Company's sole responsibility is to its Client and this document does not exonerate parties to a transaction from exercising all their rights and obligations under the transaction documents. This document cannot be reproduced except in full, without prior written approval of the Company. Any unauthorized alteration, forgery or falsification of the content or appearance of this document is unlawful and offenders may be prosecuted to the fullest extent of the law. Unless otherwise stated the results shown in this test report refer only to the sample(s) tested.

Attention: To check the authenticity of testing /inspection report & certificate, please contact us at telephone: (86-755) 8307 1443, or email: [CN.Doccheck@sgs.com](mailto:CN.Doccheck@sgs.com)

198 Kezhu Road, Sciencetech Park Guangzhou Economic & Technology Development District, Guangzhou, China 510663 t (86-20) 82155555 f (86-20) 82075113 www.sgsgroup.com.cn  
 中国·广州·经济技术开发区科学城科珠路198号 邮编: 510663 t (86-20) 82155555 f (86-20) 82075113 e [sgs.china@sgs.com](mailto:sgs.china@sgs.com)

## Test Report

No. CANEC1503027705

Date: 16 Mar 2015

Page 3 of 7

<u>Test Item(s)</u>	<u>Unit</u>	<u>MDL</u>	<u>003</u>
Dibromodiphenyl ether	mg/kg	5	ND
Tribromodiphenyl ether	mg/kg	5	ND
Tetrabromodiphenyl ether	mg/kg	5	ND
Pentabromodiphenyl ether	mg/kg	5	ND
Hexabromodiphenyl ether	mg/kg	5	ND
Heptabromodiphenyl ether	mg/kg	5	ND
Octabromodiphenyl ether	mg/kg	5	ND
Nonabromodiphenyl ether	mg/kg	5	ND
Decabromodiphenyl ether	mg/kg	5	ND

### Phthalate

Test Method : With reference to EN14372: 2004. Analysis was performed by GC-MS.

<u>Test Item(s)</u>	<u>CAS NO.</u>	<u>Unit</u>	<u>MDL</u>	<u>003</u>
Dibutyl Phthalate (DBP)	84-74-2	%(w/w)	0.003	ND
Benzylbutyl Phthalate (BBP)	85-68-7	%(w/w)	0.003	ND
Bis(2-ethylhexyl) Phthalate (DEHP)	117-81-7	%(w/w)	0.003	0.007
Diisobutyl Phthalate (DIBP)	84-69-5	%(w/w)	0.003	ND

### Notes :

Reference Information: Directive 2011/65/EU recasting RoHS directive 2002/95/EC and the latest amending directive:

(1) Bis (2-ethylhexyl) phthalate (DEHP), Butyl benzyl phthalate (BBP), and Dibutyl phthalate (DBP) are considered as a priority for risk evaluation and substance restriction.

(2) Bis (2-ethylhexyl) phthalate (DEHP), Butyl benzyl phthalate (BBP), Dibutyl phthalate (DBP) and Diisobutyl Phthalates (DIBP) have been adopted in the draft of Commission Delegated Directive amending Annex II to Directive 2011/65/EU of the European Parliament, and the regulatory limit of each restricted substances should be 0.1%.



This document is issued by the Company subject to its General Conditions of Service printed overleaf, available on request or accessible at <http://www.sgs.com/en/Terms-and-Conditions.aspx> and, for electronic format documents, subject to Terms and Conditions for Electronic Documents at <http://www.sgs.com/en/Terms-and-Conditions/Terms-e-Documents.aspx>. Attention is drawn to the limitation of liability, indemnification and jurisdiction issues defined therein. Any holder of this document is advised that information contained hereon reflects the Company's findings at the time of its intervention only and within the limits of Client's instructions, if any. The Company's sole responsibility is to its Client and this document does not exonerate parties to a transaction from exercising all their rights and obligations under the transaction documents. This document cannot be reproduced except in full, without prior written approval of the Company. Any unauthorized alteration, forgery or falsification of the content or appearance of this document is unlawful and offenders may be prosecuted to the fullest extent of the law. Unless otherwise stated the results shown in this test report refer only to the sample(s) tested.

Attention: To check the authenticity of testing / inspection report & certificate, please contact us at telephone: (86-755) 8307 1443, or email: [CN.Doccheck@sgs.com](mailto:CN.Doccheck@sgs.com)

Remark1: Results shown are of the total weight of mixed samples.

Remark2: The sample(s) was/were analyzed on behalf of the applicant as mixing sample in one testing. The above result(s) was/were only given as the informality value and only for reference.



This document is issued by the Company subject to its General Conditions of Service printed overleaf, available on request or accessible at <http://www.sgs.com/en/Terms-and-Conditions.aspx> and, for electronic format documents, subject to Terms and Conditions for Electronic Documents at <http://www.sgs.com/en/Terms-and-Conditions/Terms-e-Documents.aspx>. Attention is drawn to the limitation of liability, indemnification and jurisdiction issues defined therein. Any holder of this document is advised that information contained hereon reflects the Company's findings at the time of its intervention only and within the limits of Client's instructions, if any. The Company's sole responsibility is to its Client and this document does not exonerate parties to a transaction from exercising all their rights and obligations under the transaction documents. This document cannot be reproduced except in full, without prior written approval of the Company. Any unauthorized alteration, forgery or falsification of the content or appearance of this document is unlawful and offenders may be prosecuted to the fullest extent of the law. Unless otherwise stated the results shown in this test report refer only to the sample(s) tested.

Attention: To check the authenticity of testing /inspection report & certificate, please contact us at telephone: (86-755) 8307 1443, or email: [CN.Doccheck@sgs.com](mailto:CN.Doccheck@sgs.com)

ATTACHMENTS

Phthalates Testing Flow Chart

- 1) Name of the person who made testing: Sunny Hu
- 2) Name of the person in charge of testing: Cutey Yu

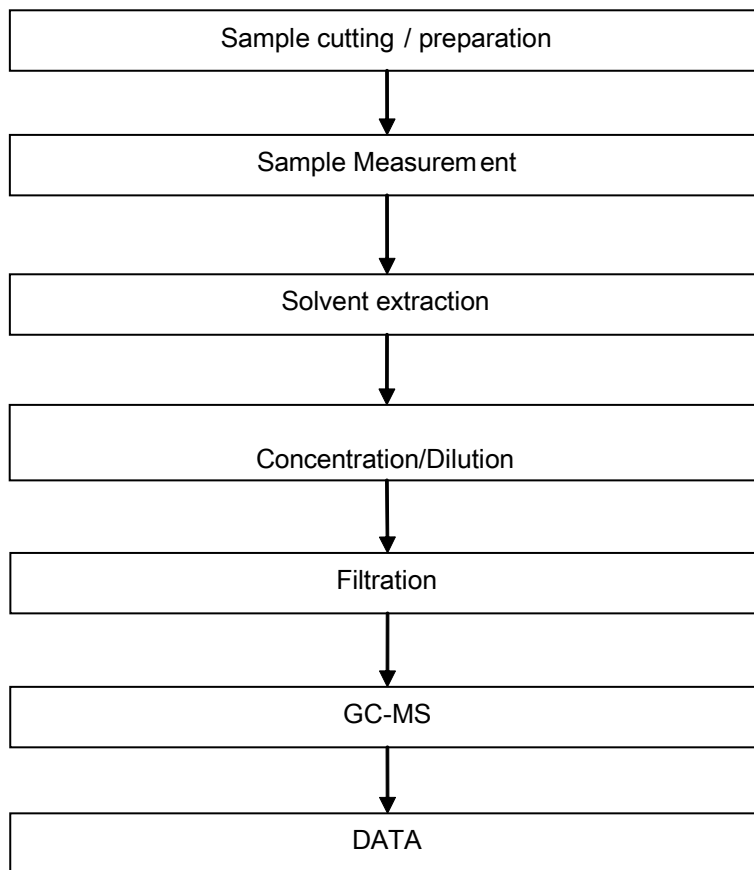

This document is issued by the Company subject to its General Conditions of Service printed overleaf, available on request or accessible at <http://www.sgs.com/en/Terms-and-Conditions.aspx> and, for electronic format documents, subject to Terms and Conditions for Electronic Documents at <http://www.sgs.com/en/Terms-and-Conditions/Terms-e-Documents.aspx>. Attention is drawn to the limitation of liability, indemnification and jurisdiction issues defined therein. Any holder of this document is advised that information contained hereon reflects the Company's findings at the time of its intervention only and within the limits of Client's instructions, if any. The Company's sole responsibility is to its Client and this document does not exonerate parties to a transaction from exercising all their rights and obligations under the transaction documents. This document cannot be reproduced except in full, without prior written approval of the Company. Any unauthorized alteration, forgery or falsification of the content or appearance of this document is unlawful and offenders may be prosecuted to the fullest extent of the law. Unless otherwise stated the results shown in this test report refer only to the sample(s) tested.

Attention: To check the authenticity of testing / inspection report & certificate, please contact us at telephone: (86-755) 8307 1443, or email: CN.Doccheck@sgs.com

198 Kezhu Road, Sciencetech Park Guangzhou Economic & Technology Development District, Guangzhou, China 510663 t (86-20) 82155555 f (86-20) 82075113 www.sgsgroup.com.cn  
 中国·广州·经济技术开发区科学城科珠路198号 邮编: 510663 t (86-20) 82155555 f (86-20) 82075113 e sgs.china@sgs.com

ATTACHMENTS

RoHS Testing Flow Chart

- 1) Name of the person who made testing: Bruce Xiao / Sunny Hu
- 2) Name of the person in charge of testing: Bella Wang / Cutey Yu
- 3) These samples were dissolved totally by pre-conditioning method according to below flow chart (Cr<sup>6+</sup> and PBBs/PBDEs test method excluded).

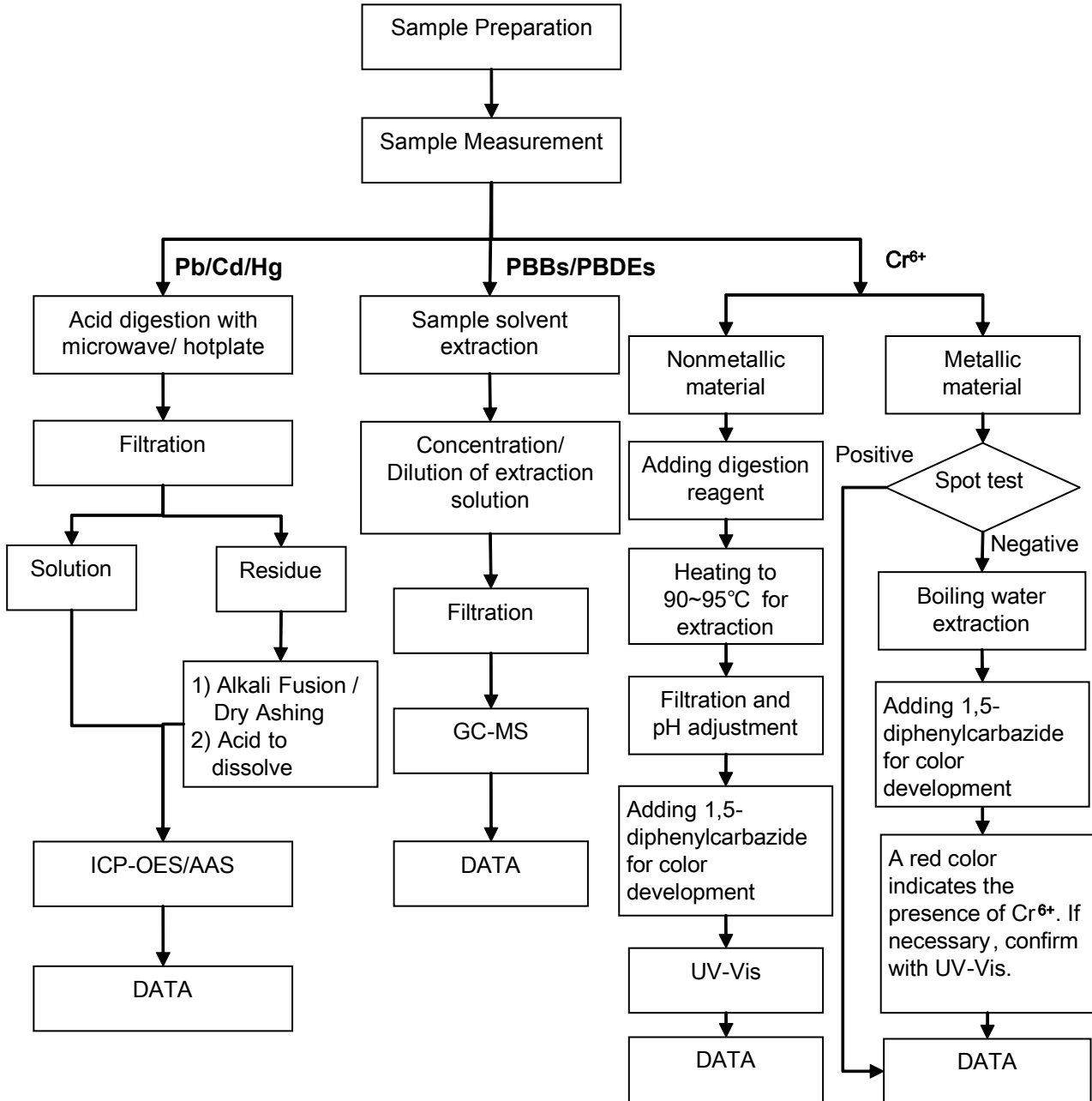

This document is issued by the Company subject to its General Conditions of Service printed overleaf, available on request or accessible at <http://www.sgs.com/en/Terms-and-Conditions.aspx> and, for electronic format documents, subject to Terms and Conditions for Electronic Documents at <http://www.sgs.com/en/Terms-and-Conditions/Terms-e-Documents.aspx>. Attention is drawn to the limitation of liability, indemnification and jurisdiction issues defined therein. Any holder of this document is advised that information contained herein reflects the Company's findings at the time of its intervention only and within the limits of Client's instructions, if any. The Company's sole responsibility is to its Client and this document does not exonerate parties to a transaction from exercising all their rights and obligations under the transaction documents. This document cannot be reproduced except in full, without prior written approval of the Company. Any unauthorized alteration, forgery or falsification of the content or appearance of this document is unlawful and offenders may be prosecuted to the fullest extent of the law. Unless otherwise stated the results shown in this test report refer only to the sample(s) tested.

Attention: To check the authenticity of testing / inspection report & certificate, please contact us at telephone: (86-755) 8307 1443, or email: CN.Doccheck@sgs.com

198 Kezhu Road, Sciencetech Park Guangzhou Economic & Technology Development District, Guangzhou, China 510663 t (86-20) 82155555 f (86-20) 82075113 www.sgsgroup.com.cn  
中国·广州·经济技术开发区科学城科珠路198号 邮编: 510663 t (86-20) 82155555 f (86-20) 82075113 e sgs.china@sgs.com



Sample photo:



SGS authenticate the photo on original report only

\*\*\* End of Report \*\*\*



## Test Report

No. CANEC1503027707

Date: 16 Mar 2015

Page 1 of 6

DING FENG PLASTICS METAL FACTORY  
CHANG HSIANG VILLAGE, HENGLI TOWN, DONGGUAN CITY, GUANGDONG  
CHINA

The following sample(s) was/were submitted and identified on behalf of the clients as : PE plastic grains

SGS Job No. : CP15-009381 - SZ  
Client Ref. Info. : PE Plastic grains  
TRANSPARENT  
Date of Sample Received : 09 Mar 2015  
Testing Period : 09 Mar 2015 - 13 Mar 2015  
Test Requested : Selected test(s) as requested by client.  
Test Method : Please refer to next page(s).  
Test Results : Please refer to next page(s).

Signed for and on behalf of  
SGS-CSTC Standards Technical Services Co., Ltd. Guangzhou Branch



Almay Gao  
Approved Signatory



This document is issued by the Company subject to its General Conditions of Service printed overleaf, available on request or accessible at <http://www.sgs.com/en/Terms-and-Conditions.aspx> and, for electronic format documents, subject to Terms and Conditions for Electronic Documents at <http://www.sgs.com/en/Terms-and-Conditions/Terms-e-Documents.aspx>. Attention is drawn to the limitation of liability, indemnification and jurisdiction issues defined therein. Any holder of this document is advised that information contained hereon reflects the Company's findings at the time of its intervention only and within the limits of Client's instructions, if any. The Company's sole responsibility is to its Client and this document does not exonerate parties to a transaction from exercising all their rights and obligations under the transaction documents. This document cannot be reproduced except in full, without prior written approval of the Company. Any unauthorized alteration, forgery or falsification of the content or appearance of this document is unlawful and offenders may be prosecuted to the fullest extent of the law. Unless otherwise stated the results shown in this test report refer only to the sample(s) tested.

Attention: To check the authenticity of testing /inspection report & certificate, please contact us at telephone: (86-755) 8307 1443, or email: [CN.Doccheck@sgs.com](mailto:CN.Doccheck@sgs.com)

198 Kezhu Road, Sciencetech Park Guangzhou Economic & Technology Development District, Guangzhou, China 510663 t (86-20) 82155555 f (86-20) 82075113 www.sgs.com.cn  
中国·广州·经济技术开发区科学城科珠路198号 邮编: 510663 t (86-20) 82155555 f (86-20) 82075113 e [sgs.china@sgs.com](mailto:sgs.china@sgs.com)

Test Results :

Test Part Description :

Specimen No.	SGS Sample ID	Description
SN1	CAN15-030277.004	White plastic grains

Remarks :

- (1) 1 mg/kg = 1 ppm = 0.0001%
- (2) MDL = Method Detection Limit
- (3) ND = Not Detected ( < MDL )
- (4) "-" = Not Regulated

**Elementary Analysis & Flame Retardants**

- Test Method :
- (1)With reference to IEC 62321-5:2013, determination of Cadmium by ICP-OES.
  - (2)With reference to IEC 62321-5:2013, determination of Lead by ICP-OES.
  - (3)With reference to IEC 62321-4:2013, determination of Mercury by ICP-OES.
  - (4)With reference to IEC 62321:2008, determination of Hexavalent Chromium by Colorimetric Method using UV-Vis.
  - (5)With reference to IEC 62321:2008, determination of PBBs and PBDEs by GC-MS.

<u>Test Item(s)</u>	<u>Unit</u>	<u>MDL</u>	<u>004</u>
Cadmium (Cd)	mg/kg	2	ND
Lead (Pb)	mg/kg	2	ND
Mercury (Hg)	mg/kg	2	ND
Hexavalent Chromium (CrVI)	mg/kg	2	ND
Sum of PBBs	mg/kg	-	ND
Monobromobiphenyl	mg/kg	5	ND
Dibromobiphenyl	mg/kg	5	ND
Tribromobiphenyl	mg/kg	5	ND
Tetrabromobiphenyl	mg/kg	5	ND
Pentabromobiphenyl	mg/kg	5	ND
Hexabromobiphenyl	mg/kg	5	ND
Heptabromobiphenyl	mg/kg	5	ND
Octabromobiphenyl	mg/kg	5	ND
Nonabromobiphenyl	mg/kg	5	ND
Decabromobiphenyl	mg/kg	5	ND
Sum of PBDEs	mg/kg	-	ND
Monobromodiphenyl ether	mg/kg	5	ND



This document is issued by the Company subject to its General Conditions of Service printed overleaf, available on request or accessible at <http://www.sgs.com/en/Terms-and-Conditions.aspx> and, for electronic format documents, subject to Terms and Conditions for Electronic Documents at <http://www.sgs.com/en/Terms-and-Conditions/Terms-e-Documents.aspx>. Attention is drawn to the limitation of liability, indemnification and jurisdiction issues defined therein. Any holder of this document is advised that information contained hereon reflects the Company's findings at the time of its intervention only and within the limits of Client's instructions, if any. The Company's sole responsibility is to its Client and this document does not exonerate parties to a transaction from exercising all their rights and obligations under the transaction documents. This document cannot be reproduced except in full, without prior written approval of the Company. Any unauthorized alteration, forgery or falsification of the content or appearance of this document is unlawful and offenders may be prosecuted to the fullest extent of the law. Unless otherwise stated the results shown in this test report refer only to the sample(s) tested.

Attention: To check the authenticity of testing /inspection report & certificate, please contact us at telephone: (86-755) 8307 1443, or email: [CN.Doccheck@sgs.com](mailto:CN.Doccheck@sgs.com)

198 Kezhu Road, Sciencetech Park Guangzhou Economic & Technology Development District, Guangzhou, China 510663 t (86-20) 82155555 f (86-20) 82075113 www.sgsgroup.com.cn  
中国·广州·经济技术开发区科学城科珠路198号 邮编: 510663 t (86-20) 82155555 f (86-20) 82075113 e [sgs.china@sgs.com](mailto:sgs.china@sgs.com)

## Test Report

No. CANEC1503027707

Date: 16 Mar 2015

Page 3 of 6

<u>Test Item(s)</u>	<u>Unit</u>	<u>MDL</u>	<u>004</u>
Dibromodiphenyl ether	mg/kg	5	ND
Tribromodiphenyl ether	mg/kg	5	ND
Tetrabromodiphenyl ether	mg/kg	5	ND
Pentabromodiphenyl ether	mg/kg	5	ND
Hexabromodiphenyl ether	mg/kg	5	ND
Heptabromodiphenyl ether	mg/kg	5	ND
Octabromodiphenyl ether	mg/kg	5	ND
Nonabromodiphenyl ether	mg/kg	5	ND
Decabromodiphenyl ether	mg/kg	5	ND

### Phthalate

Test Method : With reference to EN14372: 2004. Analysis was performed by GC-MS.

<u>Test Item(s)</u>	<u>CAS NO.</u>	<u>Unit</u>	<u>MDL</u>	<u>004</u>
Dibutyl Phthalate (DBP)	84-74-2	%(w/w)	0.003	ND
Benzylbutyl Phthalate (BBP)	85-68-7	%(w/w)	0.003	ND
Bis(2-ethylhexyl) Phthalate (DEHP)	117-81-7	%(w/w)	0.003	ND
Diisobutyl Phthalate (DIBP)	84-69-5	%(w/w)	0.003	ND

### Notes :

Reference Information: Directive 2011/65/EU recasting RoHS directive 2002/95/EC and the latest amending directive:

(1) Bis (2-ethylhexyl) phthalate (DEHP), Butyl benzyl phthalate (BBP), and Dibutyl phthalate (DBP) are considered as a priority for risk evaluation and substance restriction.

(2) Bis (2-ethylhexyl) phthalate (DEHP), Butyl benzyl phthalate (BBP), Dibutyl phthalate (DBP) and Diisobutyl Phthalates (DIBP) have been adopted in the draft of Commission Delegated Directive amending Annex II to Directive 2011/65/EU of the European Parliament, and the regulatory limit of each restricted substances should be 0.1%.



This document is issued by the Company subject to its General Conditions of Service printed overleaf, available on request or accessible at <http://www.sgs.com/en/Terms-and-Conditions.aspx> and, for electronic format documents, subject to Terms and Conditions for Electronic Documents at <http://www.sgs.com/en/Terms-and-Conditions/Terms-e-Documents.aspx>. Attention is drawn to the limitation of liability, indemnification and jurisdiction issues defined therein. Any holder of this document is advised that information contained hereon reflects the Company's findings at the time of its intervention only and within the limits of Client's instructions, if any. The Company's sole responsibility is to its Client and this document does not exonerate parties to a transaction from exercising all their rights and obligations under the transaction documents. This document cannot be reproduced except in full, without prior written approval of the Company. Any unauthorized alteration, forgery or falsification of the content or appearance of this document is unlawful and offenders may be prosecuted to the fullest extent of the law. Unless otherwise stated the results shown in this test report refer only to the sample(s) tested.

Attention: To check the authenticity of testing /inspection report & certificate, please contact us at telephone: (86-755) 8307 1443, or email: [CN.Doccheck@sgs.com](mailto:CN.Doccheck@sgs.com)

ATTACHMENTS

Phthalates Testing Flow Chart

- 1) Name of the person who made testing: Sunny Hu
- 2) Name of the person in charge of testing: Cutey Yu

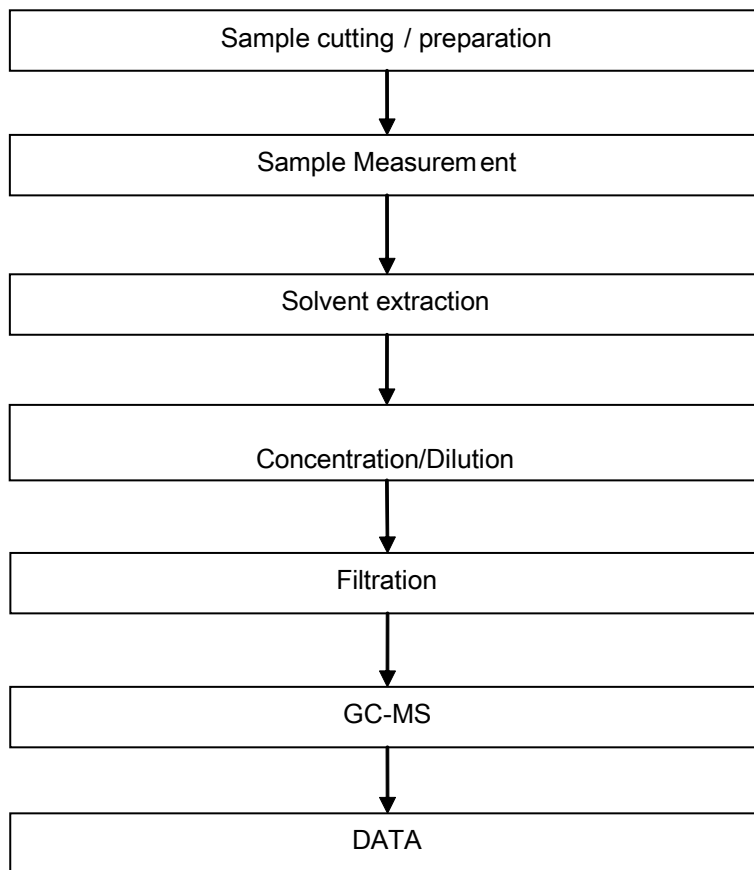

This document is issued by the Company subject to its General Conditions of Service printed overleaf, available on request or accessible at <http://www.sgs.com/en/Terms-and-Conditions.aspx> and, for electronic format documents, subject to Terms and Conditions for Electronic Documents at <http://www.sgs.com/en/Terms-and-Conditions/Terms-e-Documents.aspx>. Attention is drawn to the limitation of liability, indemnification and jurisdiction issues defined therein. Any holder of this document is advised that information contained hereon reflects the Company's findings at the time of its intervention only and within the limits of Client's instructions, if any. The Company's sole responsibility is to its Client and this document does not exonerate parties to a transaction from exercising all their rights and obligations under the transaction documents. This document cannot be reproduced except in full, without prior written approval of the Company. Any unauthorized alteration, forgery or falsification of the content or appearance of this document is unlawful and offenders may be prosecuted to the fullest extent of the law. Unless otherwise stated the results shown in this test report refer only to the sample(s) tested.

Attention: To check the authenticity of testing / inspection report & certificate, please contact us at telephone: (86-755) 8307 1443, or email: [CN.Doccheck@sgs.com](mailto:CN.Doccheck@sgs.com)

198 Kezhu Road, Sciencetech Park Guangzhou Economic & Technology Development District, Guangzhou, China 510663 t (86-20) 82155555 f (86-20) 82075113 www.sgsgroup.com.cn  
 中国·广州·经济技术开发区科学城科珠路198号 邮编: 510663 t (86-20) 82155555 f (86-20) 82075113 e [sgs.china@sgs.com](mailto:sgs.china@sgs.com)



ATTACHMENTS

RoHS Testing Flow Chart

- 1) Name of the person who made testing: Bruce Xiao / Sunny Hu
- 2) Name of the person in charge of testing: Bella Wang / Cutey Yu
- 3) These samples were dissolved totally by pre-conditioning method according to below flow chart (Cr<sup>6+</sup> and PBBs/PBDEs test method excluded).

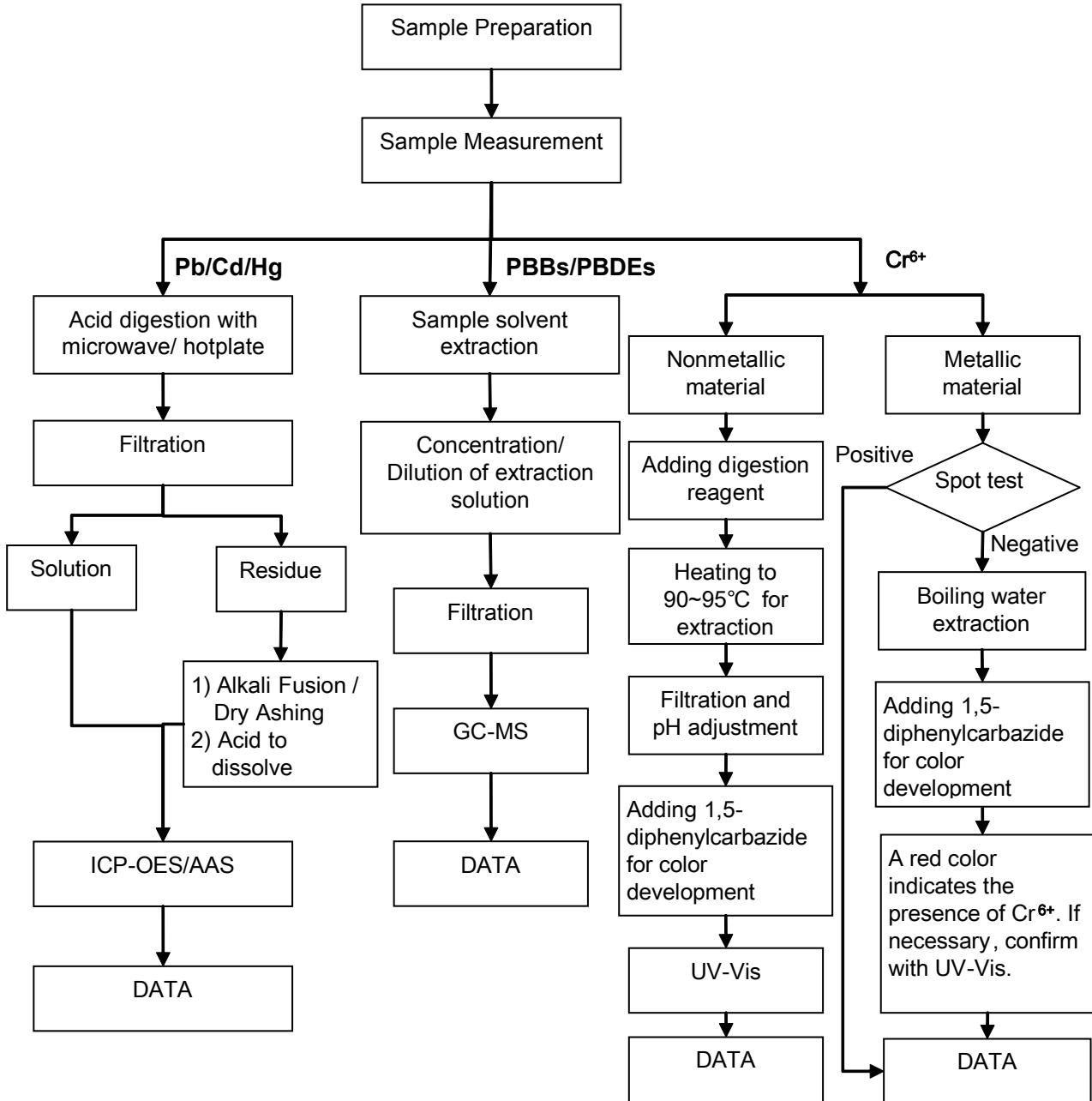

This document is issued by the Company subject to its General Conditions of Service printed overleaf, available on request or accessible at <http://www.sgs.com/en/Terms-and-Conditions.aspx> and, for electronic format documents, subject to Terms and Conditions for Electronic Documents at <http://www.sgs.com/en/Terms-and-Conditions/Terms-e-Documents.aspx>. Attention is drawn to the limitation of liability, indemnification and jurisdiction issues defined therein. Any holder of this document is advised that information contained hereon reflects the Company's findings at the time of its intervention only and within the limits of Client's instructions, if any. The Company's sole responsibility is to its Client and this document does not exonerate parties to a transaction from exercising all their rights and obligations under the transaction documents. This document cannot be reproduced except in full, without prior written approval of the Company. Any unauthorized alteration, forgery or falsification of the content or appearance of this document is unlawful and offenders may be prosecuted to the fullest extent of the law. Unless otherwise stated the results shown in this test report refer only to the sample(s) tested.

Attention: To check the authenticity of testing / inspection report & certificate, please contact us at telephone: (86-755) 8307 1443, or email: CN.Doccheck@sgs.com

198 Kezhu Road, Sciencetech Park Guangzhou Economic & Technology Development District, Guangzhou, China 510663 t (86-20) 82155555 f (86-20) 82075113 www.sgsgroup.com.cn  
中国·广州·经济技术开发区科学城科珠路198号 邮编: 510663 t (86-20) 82155555 f (86-20) 82075113 e sgs.china@sgs.com

Sample photo:



SGS authenticate the photo on original report only

\*\*\* End of Report \*\*\*



# SGS



## Test Report

No. CANEC1506705903

Date: 05 May 2015

Page 1 of 8

TAI FA PLASTICS PIGMENT CO., LTD

CHANG FA CHEMICAL FIBER CO.,LTD

NO.9,SHAOBAI ROAD,XINTANG TOWN,ZENGCHENG CITY,GUANGZHOU,GUANG DONG P.R. CHINA

The following sample(s) was/were submitted and identified on behalf of the clients as : BLACK MASTER BATCH

SGS Job No. : CP15-022863 - GZ

Date of Sample Received : 28 Apr 2015

Testing Period : 28 Apr 2015 - 05 May 2015

Test Requested : Selected test(s) as requested by client.

Test Method : Please refer to next page(s).

Test Results : Please refer to next page(s).

Conclusion : Based on the performed tests on submitted sample(s), the results of Lead, Mercury, Cadmium, Hexavalent chromium, Polybrominated biphenyls (PBBs), Polybrominated diphenyl ethers (PBDEs) comply with the limits as set by RoHS Directive 2011/65/EU Annex II; recasting 2002/95/EC.

Signed for and on behalf of  
SGS-CSTC Standards Technical Services Co., Ltd. Guangzhou Branch

Echo

Echo Yeung  
Approved Signatory



This document is issued by the Company subject to its General Conditions of Service printed overleaf, available on request or accessible at <http://www.sgs.com/en/Terms-and-Conditions.aspx> and, for electronic format documents, subject to Terms and Conditions for Electronic Documents at <http://www.sgs.com/en/Terms-and-Conditions/Terms-e-Documents.aspx>. Attention is drawn to the limitation of liability, indemnification and jurisdiction issues defined therein. Any holder of this document is advised that information contained hereon reflects the Company's findings at the time of its intervention only and within the limits of Client's instructions, if any. The Company's sole responsibility is to its Client and this document does not exonerate parties to a transaction from exercising all their rights and obligations under the transaction documents. This document cannot be reproduced except in full, without prior written approval of the Company. Any unauthorized alteration, forgery or falsification of the content or appearance of this document is unlawful and offenders may be prosecuted to the fullest extent of the law. Unless otherwise stated the results shown in this test report refer only to the sample(s) tested.  
Attention: To check the authenticity of testing /inspection report & certificate, please contact us at telephone: (86-755) 8307 1443, or email: [CN.Doccheck@sgs.com](mailto:CN.Doccheck@sgs.com)

198 Kechu Road, Science Park Guangzhou Economic & Technology Development District, Guangzhou, China 510663 t (86-20) 82155555 f (86-20) 82075113 www.sgs.com.cn  
中国·广州·经济技术开发区科学城科珠路198号 邮编: 510663 t (86-20) 82155555 f (86-20) 82075113 # [sgs.china@sgs.com](mailto:sgs.china@sgs.com)

# Test Report

No. CANEC1506705903

Date: 05 May 2015

Page 2 of 8

Test Results :

Test Part Description :

Specimen No.	SGS Sample ID	Description
SN1	CAN15-067059.003	Black master batch

Remarks :

- (1) 1 mg/kg = 0.0001%
- (2) MDL = Method Detection Limit
- (3) ND = Not Detected ( < MDL )
- (4) "-" = Not Regulated

**RoHS Directive 2011/65/EU**

- Test Method :
- (1)With reference to IEC 62321-5:2013, determination of Cadmium by ICP-OES.
  - (2)With reference to IEC 62321-5:2013, determination of Lead by ICP-OES.
  - (3)With reference to IEC 62321-4:2013, determination of Mercury by ICP-OES.
  - (4)With reference to IEC 62321:2008, determination of Hexavalent Chromium by Colorimetric Method using UV-Vis.
  - (5)With reference to IEC 62321:2008, determination of PBBs and PBDEs by GC-MS.

Test Item(s)	Limit	Unit	MDL	_____
Cadmium (Cd)	100	mg/kg	2	ND
Lead (Pb)	1,000	mg/kg	2	28
Mercury (Hg)	1,000	mg/kg	2	ND
Hexavalent Chromium (CrVI)	1,000	mg/kg	2	ND
Sum of PBBs	1,000	mg/kg	-	ND
Monobromobiphenyl	-	mg/kg	5	ND
Dibromobiphenyl	-	mg/kg	5	ND
Tribromobiphenyl	-	mg/kg	5	ND
Tetrabromobiphenyl	-	mg/kg	5	ND
Pentabromobiphenyl	-	mg/kg	5	ND
Hexabromobiphenyl	-	mg/kg	5	ND
Heptabromobiphenyl	-	mg/kg	5	ND
Octabromobiphenyl	-	mg/kg	5	ND
Nonabromobiphenyl	-	mg/kg	5	ND
Decabromobiphenyl	-	mg/kg	5	ND
Sum of PBDEs	1,000	mg/kg	-	ND
Monobromodiphenyl ether	-	mg/kg	5	ND



This document is issued by the Company subject to its General Conditions of Service printed overleaf, available on request or accessible at <http://www.sgs.com/en/Terms-and-Conditions.aspx> and, for electronic format documents, subject to Terms and Conditions for Electronic Documents at <http://www.sgs.com/en/Terms-and-Conditions/Terms-e-Documents.aspx>. Attention is drawn to the limitation of liability, indemnification and jurisdiction issues defined therein. Any holder of this document is advised that information contained hereon reflects the Company's findings at the time of its intervention only and within the limits of Client's instructions, if any. The Company's sole responsibility is to its Client and this document does not exonerate parties to a transaction from exercising all their rights and obligations under the transaction documents. This document cannot be reproduced except in full, without prior written approval of the Company. Any unauthorized alteration, forgery or falsification of the content or appearance of this document is unlawful and offenders may be prosecuted to the fullest extent of the law. Unless otherwise stated the results shown in this test report refer only to the sample(s) tested.

Attention: To check the authenticity of testing/inspection report & certificate, please contact us at telephone: (86-755) 83071443, or email: CN.Deccheck@sgs.com

198 Kechu Road, Sciencetech Park Guangzhou Economic & Technology Development District, Guangzhou, China 510663 t (86-20) 82155555 f (86-20) 82075113 www.sgs.com.cn  
 中国·广州·经济技术开发区科学城科珠路198号 邮编: 510663 t (86-20) 82155555 f (86-20) 82075113 e sgs.china@sgs.com

# Test Report

No. CANEC1506705903

Date: 05 May 2015

Page 3 of 8

<u>Test Item(s)</u>	<u>Limit</u>	<u>Unit</u>	<u>MDL</u>	<u>_____</u>
Dibromodiphenyl ether	-	mg/kg	5	ND
Tribromodiphenyl ether	-	mg/kg	5	ND
Tetrabromodiphenyl ether	-	mg/kg	5	ND
Pentabromodiphenyl ether	-	mg/kg	5	ND
Hexabromodiphenyl ether	-	mg/kg	5	ND
Heptabromodiphenyl ether	-	mg/kg	5	ND
Octabromodiphenyl ether	-	mg/kg	5	ND
Nonabromodiphenyl ether	-	mg/kg	5	ND
Decabromodiphenyl ether	-	mg/kg	5	ND

Notes :

(1) The maximum permissible limit is quoted from the directive 2011/65/EU, Annex II.

## Hexabromocyclododecane (HBCDD)

Test Method : Determination of HBCDD by GC-MS based on IEC 62321:2008.

<u>Test Item(s)</u>	<u>Unit</u>	<u>MDL</u>	<u>_____</u>
Hexabromocyclododecane (HBCDD)	mg/kg	10	ND

## Phthalate

Test Method : Determination of phthalates by GC-MS based on EN 14372:2004.

<u>Test Item(s)</u>	<u>CAS NO.</u>	<u>Unit</u>	<u>MDL</u>	<u>_____</u>
Dibutyl Phthalate (DBP)	84-74-2	%(w/w)	0.003	ND
Benzylbutyl Phthalate (BBP)	85-68-7	%(w/w)	0.003	ND
Bis(2-ethylhexyl) Phthalate (DEHP)	117-81-7	%(w/w)	0.003	ND
Diisobutyl Phthalate (DIBP)	84-69-5	%(w/w)	0.003	ND

Notes :



This document is issued by the Company subject to its General Conditions of Service printed overleaf, available on request or accessible at <http://www.sgs.com/en/Terms-and-Conditions.aspx> and, for electronic format documents, subject to Terms and Conditions for Electronic Documents at <http://www.sgs.com/en/Terms-and-Conditions/Terms-e-Documents.aspx>. Attention is drawn to the limitation of liability, indemnification and jurisdiction issues defined therein. Any holder of this document is advised that information contained hereon reflects the Company's findings at the time of its intervention only and within the limits of Client's instructions, if any. The Company's sole responsibility is to its Client and this document does not exonerate parties to a transaction from exercising all their rights and obligations under the transaction documents. This document cannot be reproduced except in full, without prior written approval of the Company. Any unauthorized alteration, forgery or falsification of the content or appearance of this document is unlawful and offenders may be prosecuted to the fullest extent of the law. Unless otherwise stated the results shown in this test report refer only to the sample(s) tested.

Attention: To check the authenticity of testing/inspection report & certificate, please contact us at telephone: (86-755) 83071443, or email: CN.Deccheck@sgs.com

198 Kechu Road, Science Park Guangzhou Economic & Technology Development District, Guangzhou, China 510663 t (86-20) 82155555 f (86-20) 82075113 www.sgs.com.cn  
 中国·广州·经济技术开发区科学城科珠路198号 邮编: 510663 t (86-20) 82155555 f (86-20) 82075113 e sgs.china@sgs.com

Reference Information: Directive 2011/65/EU recasting RoHS directive 2002/95/EC and the latest amending directive:

(1) Bis (2-ethylhexyl) phthalate (DEHP), Butyl benzyl phthalate (BBP), and Dibutyl phthalate (DBP) are considered as a priority for risk evaluation and substance restriction.

(2) Bis (2-ethylhexyl) phthalate (DEHP), Butyl benzyl phthalate (BBP), Dibutyl phthalate (DBP) and Diisobutyl Phthalates (DIBP) have been adopted in the draft of Commission Delegated Directive amending Annex II to Directive 2011/65/EU of the European Parliament, and the regulatory limit of each restricted substances should be 0.1%.



This document is issued by the Company subject to its General Conditions of Service printed overleaf, available on request or accessible at <http://www.sgs.com/en/Terms-and-Conditions.aspx> and, for electronic format documents, subject to Terms and Conditions for Electronic Documents at <http://www.sgs.com/en/Terms-and-Conditions/Terms-e-Documents.aspx>. Attention is drawn to the limitation of liability, indemnification and jurisdiction issues defined therein. Any holder of this document is advised that information contained hereon reflects the Company's findings at the time of its intervention only and within the limits of Client's instructions, if any. The Company's sole responsibility is to its Client and this document does not exonerate parties to a transaction from exercising all their rights and obligations under the transaction documents. This document cannot be reproduced except in full, without prior written approval of the Company. Any unauthorized alteration, forgery or falsification of the content or appearance of this document is unlawful and offenders may be prosecuted to the fullest extent of the law. Unless otherwise stated the results shown in this test report refer only to the sample(s) tested.

Attention: To check the authenticity of testing / inspection report & certificate, please contact us at telephone: (86-755) 83071443, or email: [CN.Deccheck@sgs.com](mailto:CN.Deccheck@sgs.com)

ATTACHMENTS

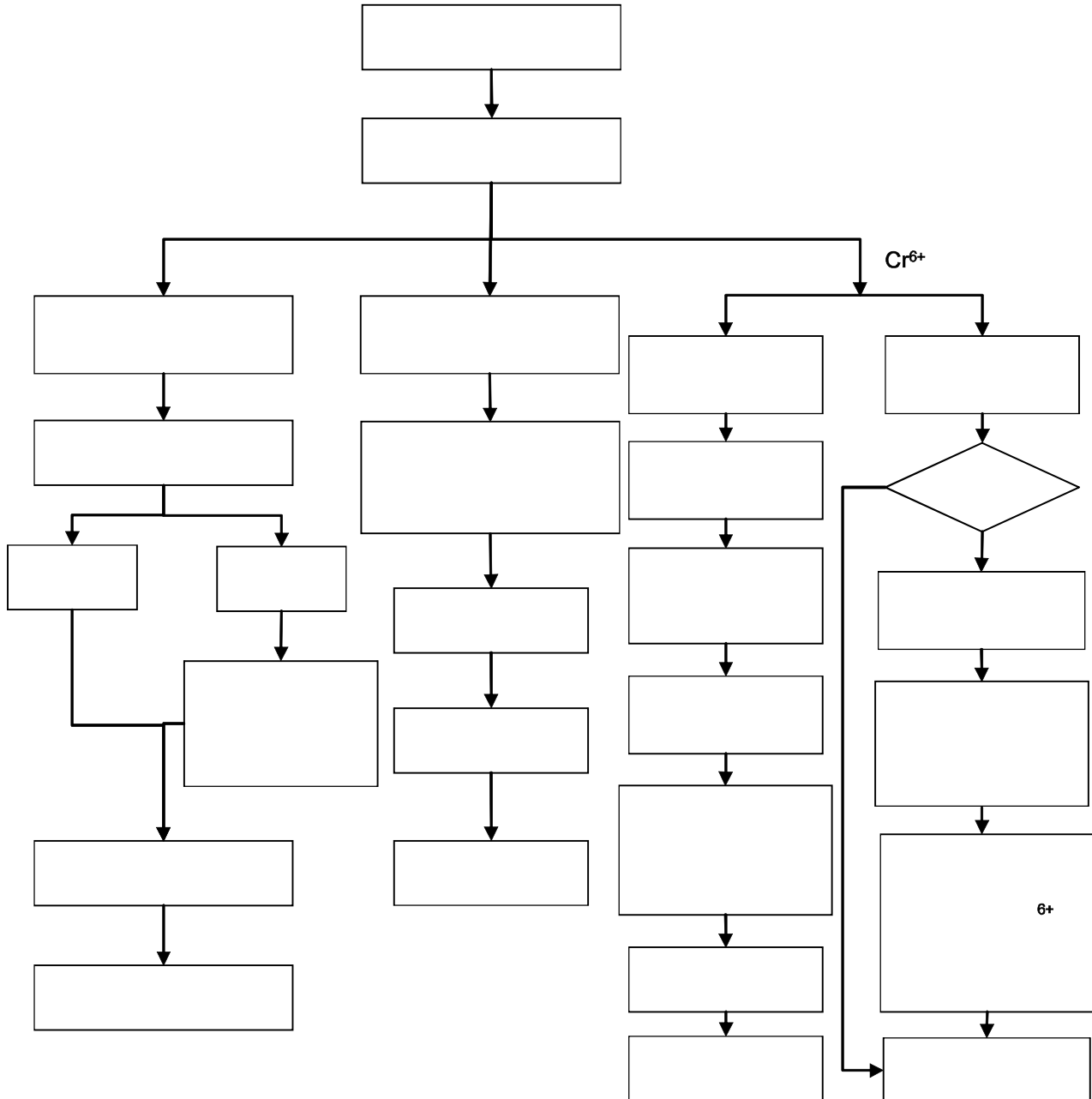



ATTACHMENTS

Phthalates Testing Flow Chart

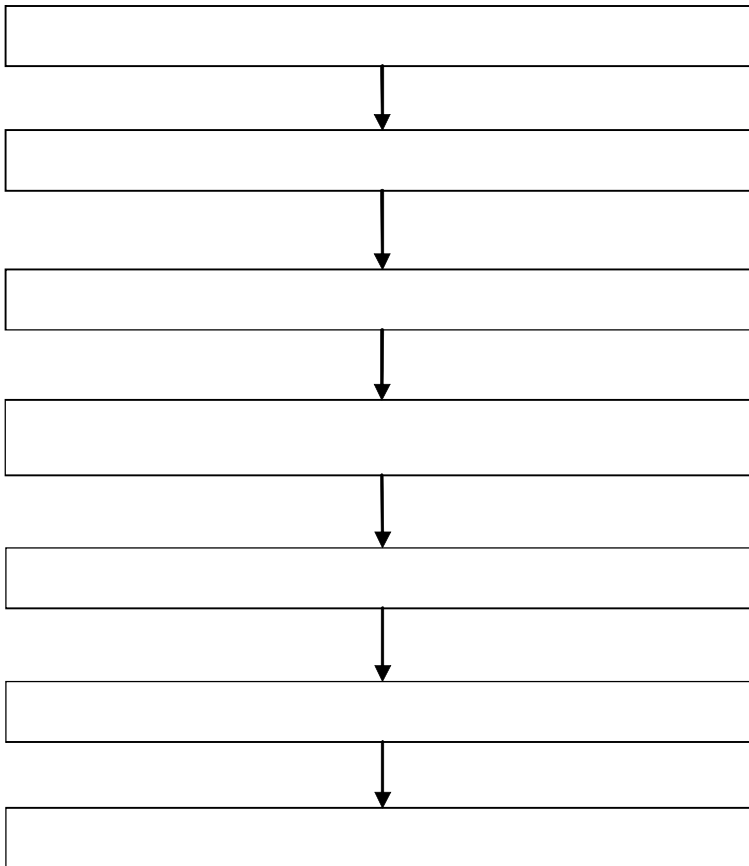



ATTACHMENTS

HBCDD Testing Flow Chart

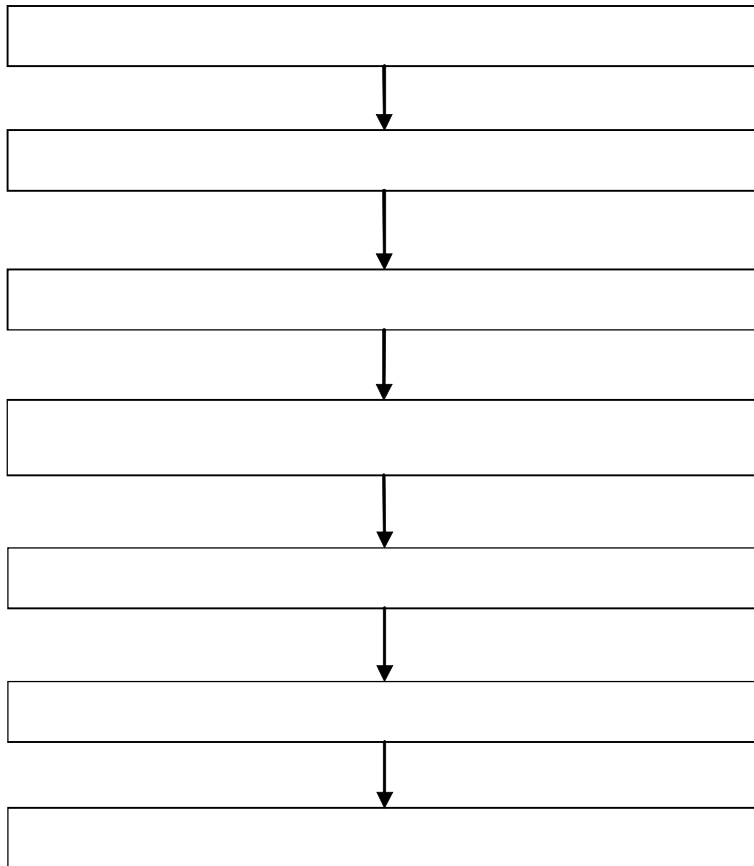

Sample photo:



SGS authenticate the photo on original report only

\*\*\* End of Report \*\*\*

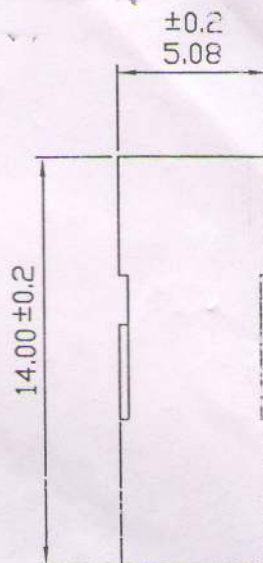
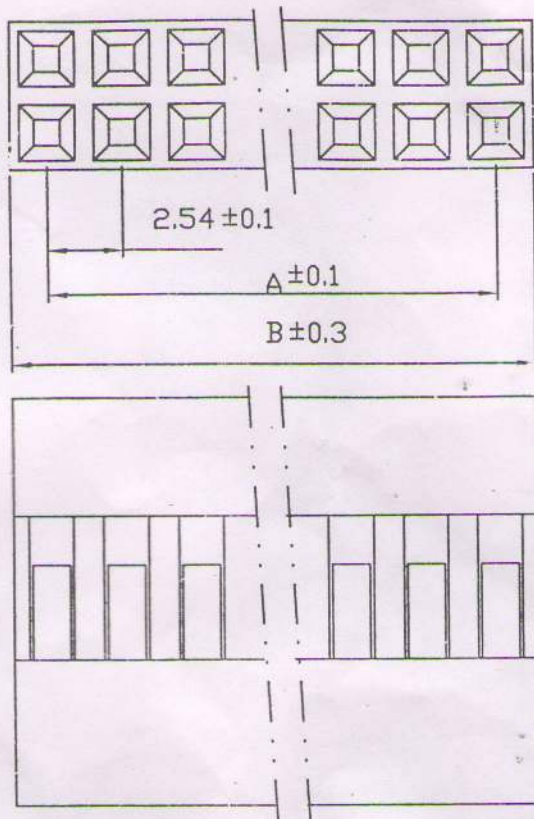

PART NO.	A	B	PART NO.	A	B
2562- 02	2.54	5.08	2562- 12	27.94	30.48
2562- 03	5.08	7.62	2562- 13	30.48	33.02
2562- 04	7.62	10.16	2562- 14	33.02	35.56
2562- 05	10.16	12.70	2562- 15	35.56	38.10
2562- 06	12.70	15.24	2562- 16	38.10	40.64
2562- 07	15.24	17.78	2562- 17	40.64	43.18
2562- 08	17.78	20.32	2562- 18	43.18	45.72
2562- 09	20.32	22.86	2562- 19	45.72	48.26
2562- 10	22.86	25.40	2562- 20	48.26	50.80
2562- 11	25.40	27.94			

2-20 CIRCUITS

MAT'L: PBT

MATES WITH: 2563 TERMINAL

ACCEPTS WITH: 2543 2545 SERIES WAFER

TEMPERATURE RANGE: -25°C TO +85°C

CURRENT RATING: 3A AC, DC

VOLTAGE RATING: 250V AC, DC

SGS REPORT NO: PX/2000/C010602

UNLESS OTHERWISE SPECIFIED			REVISIONS		REVISIONS		REVISIONS		REVISIONS	
TYPE	±0.4	±0.5	MARK	REVISED	Y. M. D.	REVISER	SCALE	UNIT	FINISH	
PARTITION	20-40	40 UP	ISSUER	YANG	CHECK		ANGLE		3TH ANGLE	
TYPE	±0.2	±0.3	 <b>旗欣股份有限公司</b> EVER CONNECTOR INDUSTRIAL CO., LTD.				DATE	DWG NO.		
PARTITION	1-10	10-20					02.03 11	2562H		

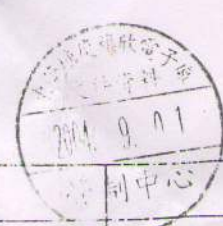



EVER-CONN  
E.C.I.

# 2563 SERIES

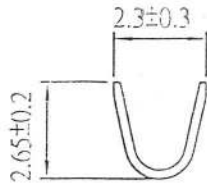

Section A-A'

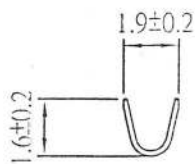

Section B-B'

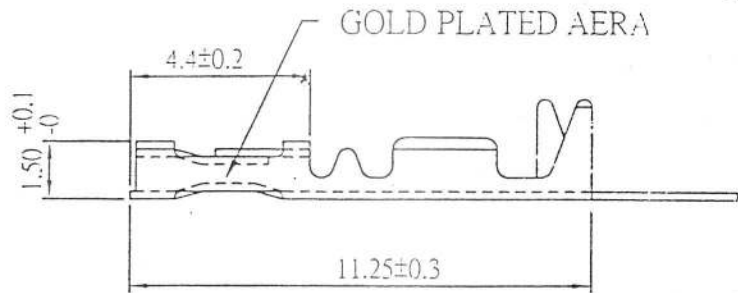
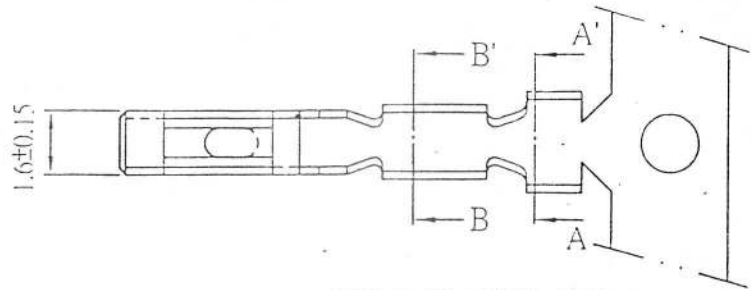

## 2563 SERIES

MAT'L: 2563 BRASS 2563P PHOSPHOR BRONZE

TREATMENT: GOLD PLATED OVER NIKEL OR TIN PLATED BEFORE STAMPING

MATES WITH: 2561 & 2561H-04K SERIES HOUSING

ACCEPTS WITH: 2540 2541 2543 2545 SERIES WAFER

ACCEPTS WITH: 2561PS-04K 2561PR-04K WAFER

MATES: 0.64(.025") SQUIRE PIN OR ROUND PIN

WIRE RANGE: AWG# 24-26

CSA FILE NO.: LR84767

備註  
REMARKS REV 0

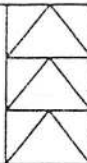

TOLERANCES UNLESS OTHERWISE SPECIFIED	TYPE	±0.4	±0.5	MARK	REVISED	Y. M. D.	REVISER	ACALE	UNIT	mm
	PARTITION	20-40	40 UP	ISSUER	YANG	CHECK		ANGLE	3TH ANGLE	
	TYPE	±0.2	±0.3	 <b>旗欣股份有限公司</b> EVER CONNECTOR INDUSTRIAL CO., LTD.	DATE	DWG NO.				
	PARTITION	1-10	10-20		04.09.10	2563				

**ECBT2.E115256****Connectors for Use in Data, Signal, Control and Power Applications - Component**[Page Bottom](#)**Connectors for Use in Data, Signal, Control and Power Applications - Component**[See General Information for Connectors for Use in Data, Signal, Control and Power Applications - Component](#)**EVER-CONN INDUSTRIAL CO LTD**

E115256

1 LANE 91 PEN CHOU RD  
KANGSHAN, KAOHSIUNG HSIEN 820 TAIWAN

**Connectors**, Model(s) 1510H--02 thru 1510H-13, 1510PR-02 thru 1510PR-13, 1510PS- 02 thru 1510PS-13, 2001PS-02 thru 2001PS-40, 2002PS-02 thru 2002PS-40, 2003PR-02 thru 2003PR-40, 2004PR-02 thru 2004PR-40, 2010R-02 thru 2010R-15, 2031H-02 thru 2031H-40, 2032H-02 thru 2032H-40, 2040H-02 thru 2040H-15, 2501CH-02 thru 2501CH-18, 2501H-02 thru 2501H-20, 2501PR-02 thru 2501PR-20, 2501PS-02 thru 2501PS-20, 2520R-02 thru 2520R-15, 2530-02 thru 2530-20, 2532-02 thru 2532-20, 2533-02 thru 2533-20, 2542H-02 thru 2542H-12, 2542PR-02 thru 2542PR-12, 2542PR-02E thru 2542PR-12E, 2542PS-02 thru 2542PS-12, 2561-04K-02 thru 2561-04K-15, 2561H-01 thru 2561H-40, 2561PR-04K-02 thru 2561PR-04K-15, 2561PS-04K-02 thru 2561PS-04K-15

2562H, followed by 04, 06, 08, 10, 12, 14, 16, 18, 20, 22, 24, 26, 28, 30, 32, 34, 36, 38, 40, 42, 44, 46, 48, 50, 52, 54, 56, 58, 60, 62, 64, 66, 68, 70, 72, 74, 76, 78 or 80, followed by A or blank.

2570H-02 thru 2570H-15, 2570PR-02 thru 2570PR-15, 2570PS-02 thru 2570PS-15, 2580H-02 thru 2580H-15, 2580PR-02 thru 2580PR-15, 2580PS-02 thru 2580PS-15, 2601CH-02 thru 2601CH-18

3015H, followed by -02 thru -12, followed by S or SE.

3015H, followed by -02, -04, -06, -08, -10, -12, -14, -16, -18, -20, -22 or -24, followed by E or blank.

3015PR, followed by -02 thru -12, followed by S.

3015PR, followed by -02, -04, -06, -08, -10, -12, -14, -16, -18, -20, -22 or -24.

3015PS, followed by -02 thru -12, followed by S.

3015PS, followed by -02, -04, -06, -08, -10, -12, -14, -16, 18, -20, -22 or -24.

3016H, followed by -02 thru -12, followed by S.

3016H, followed by -02, -04, -06, -08, -10, -12, -14, -16, -18, -20, -22 or -24.

4001H, 4001PS, 5015H-02(1\*2), 5015H-02E(1\*2), 5015H-2x-01P thru 5015H-2x-12P, 5015PR-02(1\*2), 5015PR-2x-01P thru 5015PR-2x-12P, 5015PS-02(1\*2), 5015PS-2x-01P thru 5015PS-2x-12P, 5016H-02(1\*2), 5016H-2x-01P thru 5016H-2x-12P, 7521H-01, 8396H-02 thru 8396H-14, 8508H-02 thru 8508H-12, 8613H-04, 8625H, 8639-02 thru 8639-20, 8673-02 thru 8673-20, 8674-02 thru 8674-20, D181H-02 thru D181H-15, DAM-TK-NF, DAS-TK-NF, DBM-TK-NF, DBS-TK-NF, DCH-15P, DCH-15S, DCH-25P, DCH-25S, DCH-9P, DCH-9S, DHM-TK-NF, DHS-TK-NF, DIM-TK-NF, DIS-TK-NF

DMR, followed by -9, -15, -25, -37 or -H15, followed by P or S, may be followed by -02

E020H-01, E020H-02, E020H-03, E020H-04, E020H-06, E020H-09, E020H-12, E020H-15, E021H-01, E021H-02(1X2), E021H-03(1X3), E021H-04(1X4), E021H-05(1X5), E021H-06(3X2), E021H-09(3X3), E021H-12(3X4), E021H-15(3X5), E120H-01, E120H-02, E120H-03, E120H-04, E120H-06, E120H-09, E120H-12, E120H-15, E121H-01, E121H-02(1X2), E121H-03(1X3), E121H-04(1X4), E121H-05(1X5), E121H-06(3X2), E121H-09(3X3), E121H-12(3X4), E121H-15(3X5)

Female connectors 1081-01 thru 1081-06 and Mating pin headers 1081-01 thru 1081-06 or 1081-01L thru 1081-06L.

Female connectors 250H-02 thru 250H-20 and Mating pin headers 250PR-02 thru 250PR -20 or 250PS-02 thru 250PS.

Female connectors 2510-02 thru 2510-21 and Mating pin headers 2600PR-02 thru 2600PR -20 or 2600PS-02 thru 2600PS-20.

Female connectors 2550-02 thru 2550-25 and Mating pin headers 2540-02 thru 2540-40 or 2541-02 thru 2541-40.

Female connectors 2551-04 thru 2551-54 and Mating pin headers 2543-02 thru 2543-40 or 2545-02 thru 2545-40.

Female connectors 3095-06 thru 3095-12 and Mating pin headers 3096-06 thru 3096-12.

Female connectors 3960-02 thru 3960-11 and Mating pin headers 3961-02 thru 3961-11 or 3962-02 thru 3962-11.

Female connectors 5080-02 thru 5080-15 and Mating pin headers 5081-02 thru 5081-15, 5082-02 thru 5082-15, 5083-02 thru 5083-15 or 5084-02 thru 5084-15.

Female connectors 7500-02 thru 7500-10 and Mating pin headers 7501-02 thru 7501-10, 7502-02 thru 7502-10, 7503-02 thru 7503-10 or 7504-02 thru 7504-10.

Female connectors 7550-01 thru 7550-06 and Mating pin headers 7551-01 thru 7551-06 or 7551-01L thru 7551-06L.

Female connectors 8620-4 and Mating pin headers 8621-4 or 8622-4.

Female connectors 8639-02 thru 8639-21 or 8669-02 thru 8669-20 and Mating pin headers 8673-02 thru 8673-20, 8674-02 thru 8674-20, 8675-02 thru 8675-20 or 8676-02 thru 8676-20.

Female header connectors 2021-02 thru 2021-20 or 2022-02 thru 2022-20 and Mating connectors 2020-02 thru 2020-20.

M125H-02 thru M125H-15, M125PR-02 thru M125PR-15, M125PS-02 thru M125PS-15

**Crimp terminal housings**, Model(s) 2520-02 thru 2520-20

**Female connectors**, Model(s) 2010-02 thru 2010-16

Marking: Company name or tradename "E115256", "ECI" or trademark

**E . C . I . EVER**  **CONN E** and

model designation on the device or carton.

Last Updated on 2013-09-30

[Questions?](#)

[Print this page](#)

[Terms of Use](#)

[Page Top](#)

◆ 2015 UL LLC

The appearance of a company's name or product in this database does not in itself assure that products so identified have been manufactured under UL's Follow-Up Service. Only those products bearing the UL Mark should be considered to be Certified and covered under UL's Follow-Up Service. Always look for the Mark on the product.

UL permits the reproduction of the material contained in the Online Certification Directory subject to the following conditions: 1. The Guide Information, Assemblies, Constructions, Designs, Systems, and/or Certifications (files) must be presented in their entirety and in a non-misleading manner, without any manipulation of the data (or drawings). 2. The statement "Reprinted from the Online Certifications Directory with permission from UL" must appear adjacent to the extracted material. In addition, the reprinted material must include a copyright notice in the following format: "© 2015 UL LLC".



# 东莞市美塑塑料科技有限公司

东莞市寮步镇泉塘工业区曲岭二路 11 号

DONGGUAN PLENTY POLYMERIC TECHNOLOGY CO.,LTD

NO.11 QULING,QUANTANG MANAGEMENT DISTRICT,  
LIAOBU TOWN,DONGGUAN CITY,GUANGDONG

TEL: +86-769-81259959

FAX: +86-769-83300933

## 材 质 证 明

MATERIAL FORMULATION CONFIDENTIAL REPORT

SUPPLIER: 东莞美塑塑料科技有限公司

TYPE OF MATERIAL: PBT(Poly Butylene Terephthalate)聚丁烯对苯二甲酸酯

Specification: PBT Bogen206

Description: PBT Bogen206 复合材料包含 PBT 树脂、玻璃纤维、阻燃剂、其它。

The raw material of PBT-Bogen206 compound contains PBT pure resin, glass fiber, flame retardant, and additives.

### PBT 复合材料成分表

Chemical Composition of PBT Compound

规格 Grade		CAS Number& Content	
组成 Chemical Composition	Molecular Formula	CAS Number	含量 (%) Content(%)
1 PBT 树脂 PBT Resin	$(\text{CH}_2\text{-CH}_2\text{-CH}_2\text{-CH}_2\text{-O-C-O-C-O})_N$	26062-94-2	52~63
2 玻璃纤维 Glass Fiber	$\text{SiO}_2 \cdot \text{CaO} \cdot \text{Al}_2\text{O}_3$	65997-17-3	10~30
3 阻燃剂 Flame Retardant	$\text{C}_{21}\text{H}_6\text{Br}_9\text{N}_3\text{O}_3$	25713-60-4	12~15
4 色母 Few of Additives	_____	_____	0.5

## 測試報告 Test Report

號碼(No.) : KA/2014/C2293 日期(Date) : 2015/01/05 頁數(Page) : 1 of 4

旗欣股份有限公司  
EVER CONNECTOR INDUSTRIAL CO., LTD  
高雄市岡山區本洲路91巷1號  
NO.1 LANE 91 PEN CHOU RD. KANGSHAN KAOHSIUNG CITY TAIWAN R.O.C.

以下測試樣品係由客戶送樣，且由客戶聲稱並經客戶確認如下  
(The following samples was/were submitted and identified by/on behalf of the client as) :

樣品名稱(Sample Description) : PBT  
收件日期(Sample Receiving Date) : 2014/12/27  
測試期間(Testing Period) : 2014/12/27 TO 2015/01/05  
送樣廠商(Sample Submitted By) : 旗欣股份有限公司 (EVER CONNECTOR INDUSTRIAL CO., LTD)

測試結果(Test Results) : 請見下一頁 (Please refer to next pages).

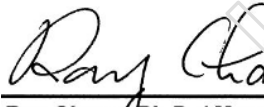

Ray Chang, Ph.D. / Manager  
Signed for and on behalf of  
SGS Taiwan Limited  
Chemical Laboratory-Kangshan



Unless otherwise stated the results shown in this test report refer only to the sample(s) tested. This test report cannot be reproduced, except in full, without prior written permission of the Company. 除非另有說明，此報告結果僅對測試之樣品負責。本報告未經本公司書面許可，不可部分複製。  
This document is issued by the Company subject to its General Conditions of Service printed overleaf, available on request or accessible at [www.sgs.com/terms\\_and\\_conditions.htm](http://www.sgs.com/terms_and_conditions.htm) and, for electronic format documents, subject to Terms and Conditions for Electronic Documents at [www.sgs.com/terms\\_e-document.htm](http://www.sgs.com/terms_e-document.htm). Attention is drawn to the limitation of liability, indemnification and jurisdiction issues defined therein. Any holder of this document is advised that information contained hereon reflects the Company's findings at the time of its intervention only and within the limits of Client's instructions, if any. The Company's sole responsibility is to its Client and this document does not exonerate parties to a transaction from exercising all their rights and obligations under the transaction documents. This document cannot be reproduced except in full, without prior written approval of the Company. Any unauthorized alteration, forgery or falsification of the content or appearance of this document is unlawful and offenders may be prosecuted to the fullest extent of the law.

SGS Taiwan Ltd.  
台灣檢驗科技股份有限公司

No. 61, Kai-Fa Road, Nanzih Export Processing Zone, Kaohsiung, Taiwan /  
t + 886 (07)301 2121 f + 886 (07)3010867

高雄市楠梓加工出口區開發路61號  
www.tw.sgs.com

Member of the SGS Group



# 測試報告 Test Report

號碼(No.) : KA/2014/C2293 日期(Date) : 2015/01/05 頁數(Page) : 2 of 4

旗欣股份有限公司  
EVER CONNECTOR INDUSTRIAL CO., LTD  
高雄市岡山區本洲路91巷1號  
NO.1 LANE 91 PEN CHOU RD. KANGSHAN KAOHSIUNG CITY TAIWAN R.O.C.

## 測試結果(Test Results)

測試部位(PART NAME) NO.1 : 黑色 PBT (BLACK PBT)

測試項目 (Test Items)	單位 (Unit)	測試方法 (Method)	方法偵測 極限值 (MDL)	結果 (Result)
				NO.1
鹵素 / Halogen				
鹵素 (氟) / Halogen-Fluorine (F) (CAS No.: 014762-94-8)	mg/kg	參考BS EN 14582:2007, 以離子層析儀分析。 / With reference to BS EN 14582:2007. Analysis was performed by IC.	50	n.d.
鹵素 (氯) / Halogen-Chlorine (Cl) (CAS No.: 022537-15-1)	mg/kg	參考BS EN 14582:2007, 以離子層析儀分析。 / With reference to BS EN 14582:2007. Analysis was performed by IC.	50	n.d.
鹵素 (溴) / Halogen-Bromine (Br) (CAS No.: 010097-32-2)	mg/kg	參考BS EN 14582:2007, 以離子層析儀分析。 / With reference to BS EN 14582:2007. Analysis was performed by IC.	50	90.4
鹵素 (碘) / Halogen-Iodine (I) (CAS No.: 014362-44-8)	mg/kg	參考BS EN 14582:2007, 以離子層析儀分析。 / With reference to BS EN 14582:2007. Analysis was performed by IC.	50	n.d.

### 備註(Note) :

1. mg/kg = ppm ; 0.1wt% = 1000ppm
2. n.d. = Not Detected (未檢出)
3. MDL = Method Detection Limit (方法偵測極限值)

Unless otherwise stated the results shown in this test report refer only to the sample(s) tested. This test report cannot be reproduced, except in full, without prior written permission of the Company. 除非另有說明, 此報告結果僅對測試之樣品負責。本報告未經本公司書面許可, 不可部分複製。  
This document is issued by the Company subject to its General Conditions of Service printed overleaf, available on request or accessible at [www.sgs.com/terms\\_and\\_conditions.htm](http://www.sgs.com/terms_and_conditions.htm) and, for electronic format documents, subject to Terms and Conditions for Electronic Documents at [www.sgs.com/terms\\_e-document.htm](http://www.sgs.com/terms_e-document.htm). Attention is drawn to the limitation of liability, indemnification and jurisdiction issues defined therein. Any holder of this document is advised that information contained hereon reflects the Company's findings at the time of its intervention only and within the limits of Client's instructions, if any. The Company's sole responsibility is to its Client and this document does not exonerate parties to a transaction from exercising all their rights and obligations under the transaction documents. This document cannot be reproduced except in full, without prior written approval of the Company. Any unauthorized alteration, forgery or falsification of the content or appearance of this document is unlawful and offenders may be prosecuted to the fullest extent of the law.

SGS Taiwan Ltd.  
台灣檢驗科技股份有限公司

No. 61, Kai-Fa Road, Nanzih Export Processing Zone, Kaohsiung, Taiwan /  
t + 886 (07)301 2121

高雄市楠梓加工出口區開發路61號  
f + 886 (07)3010867

[www.tw.sgs.com](http://www.tw.sgs.com)

Member of the SGS Group

## 測試報告 Test Report

號碼(No.) : KA/2014/C2293 日期(Date) : 2015/01/05 頁數(Page) : 3 of 4

旗欣股份有限公司  
EVER CONNECTOR INDUSTRIAL CO., LTD  
高雄市岡山區本洲路91巷1號  
NO.1 LANE 91 PEN CHOU RD. KANGSHAN KAOHSIUNG CITY TAIWAN R.O.C.

### 鹵素分析流程圖 / Analytical flow chart of halogen content

- 1) 測試人員：洪秀真 / Name of the person who made measurement: Jean Hung
- 2) 測試負責人：張伯睿 / Name of the person in charge of measurement: Ray Chang

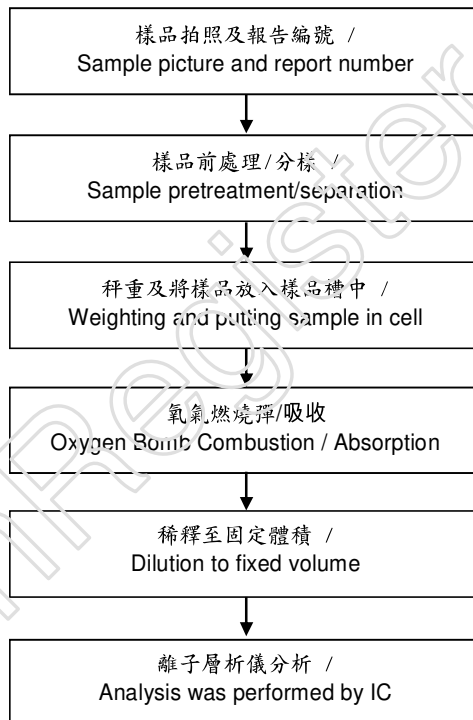

Unless otherwise stated the results shown in this test report refer only to the sample(s) tested. This test report cannot be reproduced, except in full, without prior written permission of the Company. 除非另有說明，此報告結果僅對測試之樣品負責。本報告未經本公司書面許可，不可部分複製。  
This document is issued by the Company subject to its General Conditions of Service printed overleaf, available on request or accessible at [www.sgs.com/terms\\_and\\_conditions.htm](http://www.sgs.com/terms_and_conditions.htm) and, for electronic format documents, subject to Terms and Conditions for Electronic Documents at [www.sgs.com/terms\\_e-document.htm](http://www.sgs.com/terms_e-document.htm). Attention is drawn to the limitation of liability, indemnification and jurisdiction issues defined therein. Any holder of this document is advised that information contained hereon reflects the Company's findings at the time of its intervention only and within the limits of Client's instructions, if any. The Company's sole responsibility is to its Client and this document does not exonerate parties to a transaction from exercising all their rights and obligations under the transaction documents. This document cannot be reproduced except in full, without prior written approval of the Company. Any unauthorized alteration, forgery or falsification of the content or appearance of this document is unlawful and offenders may be prosecuted to the fullest extent of the law.

## 測試報告 Test Report

號碼(No.) : KA/2014/C2293 日期(Date) : 2015/01/05 頁數(Page) : 4 of 4

旗欣股份有限公司

EVER CONNECTOR INDUSTRIAL CO., LTD

高雄市岡山區本洲路91巷1號

NO.1 LANE 91 PEN CHOU RD. KANGSHAN KAOHSIUNG CITY TAIWAN R.O.C.

\* 照片中如有箭頭標示，則表示為實際檢測之樣品/部位。\*  
(The tested sample / part is marked by an arrow if it's shown on the photo.)

### KA/2014/C2293



\*\* 報告結尾(End of Report) \*\*

Unless otherwise stated the results shown in this test report refer only to the sample(s) tested. This test report cannot be reproduced, except in full, without prior written permission of the Company. 除非另有說明，此報告結果僅對測試之樣品負責。本報告未經本公司書面許可，不可部分複製。  
This document is issued by the Company subject to its General Conditions of Service printed overleaf, available on request or accessible at [www.sgs.com/terms\\_and\\_conditions.htm](http://www.sgs.com/terms_and_conditions.htm) and, for electronic format documents, subject to Terms and Conditions for Electronic Documents at [www.sgs.com/terms\\_e-document.htm](http://www.sgs.com/terms_e-document.htm). Attention is drawn to the limitation of liability, indemnification and jurisdiction issues defined therein. Any holder of this document is advised that information contained hereon reflects the Company's findings at the time of its intervention only and within the limits of Client's instructions, if any. The Company's sole responsibility is to its Client and this document does not exonerate parties to a transaction from exercising all their rights and obligations under the transaction documents. This document cannot be reproduced except in full, without prior written approval of the Company. Any unauthorized alteration, forgery or falsification of the content or appearance of this document is unlawful and offenders may be prosecuted to the fullest extent of the law.

SGS Taiwan Ltd.  
台灣檢驗科技股份有限公司

No. 61, Kai-Fa Road, Nanzih Export Processing Zone, Kaohsiung, Taiwan /  
t + 886 (07)301 2121

f + 886 (07)3010867

高雄市楠梓加工出口區開發路61號  
www.tw.sgs.com

Member of the SGS Group

## 測試報告 Test Report

號碼(No.) : KA/2014/C2296 日期(Date) : 2015/01/05 頁數(Page) : 1 of 8

旗欣股份有限公司  
EVER CONNECTOR INDUSTRIAL CO., LTD  
高雄市岡山區本洲路91巷1號  
NO.1 LANE 91 PEN CHOU RD. KANGSHAN KAOHSIUNG CITY TAIWAN R.O.C.

以下測試樣品係由客戶送樣，且由客戶聲稱並經客戶確認如下 (The following samples was/were submitted and identified by/on behalf of the client as) :

樣品名稱(Sample Description) : TERMINAL-BRASS  
收件日期(Sample Receiving Date) : 2014/12/27  
測試期間(Testing Period) : 2014/12/27 TO 2015/01/05  
送樣廠商(Sample Submitted By) : 旗欣股份有限公司 (EVER CONNECTOR INDUSTRIAL CO., LTD)

=====  
測試結果(Test Results) : 請見下一頁 (Please refer to next pages).

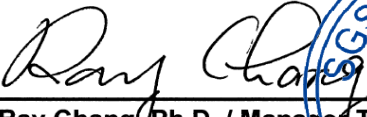
  
Ray Chang, Ph.D. / Manager-Tech  
Signed for and on behalf of  
SGS Taiwan Limited  
Chemical Laboratory-Kaohsiung



Unless otherwise stated the results shown in this test report refer only to the sample(s) tested. This test report cannot be reproduced, except in full, without prior written permission of the Company. 除非另有說明，此報告結果僅對測試之樣品負責。本報告未經本公司書面許可，不可部分複製。  
This document is issued by the Company subject to its General Conditions of Service printed overleaf, available on request or accessible at [www.sgs.com/terms\\_and\\_conditions.htm](http://www.sgs.com/terms_and_conditions.htm) and, for electronic format documents, subject to Terms and Conditions for Electronic Documents at [www.sgs.com/terms\\_e-document.htm](http://www.sgs.com/terms_e-document.htm). Attention is drawn to the limitation of liability, indemnification and jurisdiction issues defined therein. Any holder of this document is advised that information contained hereon reflects the Company's findings at the time of its intervention only and within the limits of Client's instructions, if any. The Company's sole responsibility is to its Client and this document does not exonerate parties to a transaction from exercising all their rights and obligations under the transaction documents. This document cannot be reproduced except in full, without prior written approval of the Company. Any unauthorized alteration, forgery or falsification of the content or appearance of this document is unlawful and offenders may be prosecuted to the fullest extent of the law.



# 測試報告 Test Report

號碼(No.) : KA/2014/C2296 日期(Date) : 2015/01/05 頁數(Page) : 2 of 8

旗欣股份有限公司  
EVER CONNECTOR INDUSTRIAL CO., LTD  
高雄市岡山區本洲路91巷1號  
NO.1 LANE 91 PEN CHOU RD. KANGSHAN KAOHSIUNG CITY TAIWAN R.O.C.

## 測試結果(Test Results)

測試部位(PART NAME) NO.1 : 整體混測: TERMINAL-BRASS (MIXED ALL PARTS: TERMINAL-BRASS)

測試項目 (Test Items)	單位 (Unit)	測試方法 (Method)	方法偵測 極限值 (MDL)	結果 (Result)
				NO.1
鎘 / Cadmium (Cd)	mg/kg	參考IEC 62321-5: 2013方法, 以感應耦合電漿原子發射光譜儀檢測. / With reference to IEC 62321-5: 2013 and performed by ICP-AES.	2	n.d.
鉛 / Lead (Pb)	mg/kg	參考IEC 62321-5: 2013方法, 以感應耦合電漿原子發射光譜儀檢測. / With reference to IEC 62321-5: 2013 and performed by ICP-AES.	2	6.03
汞 / Mercury (Hg)	mg/kg	參考IEC 62321-4: 2013方法, 以感應耦合電漿原子發射光譜儀檢測. / With reference to IEC 62321-4: 2013 and performed by ICP-AES.	2	n.d.
六價鉻 / Hexavalent Chromium Cr(VI) by boiling water extraction#	**	參考IEC 62321: 2008方法, 用 boiling water extraction方法檢測. / With reference to IEC 62321: 2008 and performed by boiling water extraction Method.	0.02mg/kg with 50 cm <sup>2</sup> surface area	Negative
全氟辛烷磺酸 / Perfluorooctane sulfonates (PFOS - Acid, Metal Salt, Amide)	mg/kg	參考US EPA 3550C: 2007方法, 以液相層析/質譜儀檢測. / With reference to US EPA 3550C: 2007. Analysis was performed by LC/MS.	10	n.d.
全氟辛酸(銨) / PFOA (CAS No.: 335-67-1)	mg/kg	參考US EPA 3550C: 2007方法, 以液相層析/質譜儀檢測. / With reference to US EPA 3550C: 2007. Analysis was performed by LC/MS.	10	n.d.

Unless otherwise stated the results shown in this test report refer only to the sample(s) tested. This test report cannot be reproduced, except in full, without prior written permission of the Company. 除非另有說明, 此報告結果僅對測試之樣品負責。本報告未經本公司書面許可, 不可部分複製。  
This document is issued by the Company subject to its General Conditions of Service printed overleaf, available on request or accessible at [www.sgs.com/terms\\_and\\_conditions.htm](http://www.sgs.com/terms_and_conditions.htm) and, for electronic format documents, subject to Terms and Conditions for Electronic Documents at [www.sgs.com/terms\\_e-document.htm](http://www.sgs.com/terms_e-document.htm). Attention is drawn to the limitation of liability, indemnification and jurisdiction issues defined therein. Any holder of this document is advised that information contained hereon reflects the Company's findings at the time of its intervention only and within the limits of Client's instructions, if any. The Company's sole responsibility is to its Client and this document does not exonerate parties to a transaction from exercising all their rights and obligations under the transaction documents. This document cannot be reproduced except in full, without prior written approval of the Company. Any unauthorized alteration, forgery or falsification of the content or appearance of this document is unlawful and offenders may be prosecuted to the fullest extent of the law.

# 測試報告

## Test Report

號碼(No.) : KA/2014/C2296 日期(Date) : 2015/01/05 頁數(Page) : 3 of 8

旗欣股份有限公司

EVER CONNECTOR INDUSTRIAL CO., LTD

高雄市岡山區本洲路91巷1號

NO.1 LANE 91 PEN CHOU RD. KANGSHAN KAOHSIUNG CITY TAIWAN R.O.C.

測試項目 (Test Items)	單位 (Unit)	測試方法 (Method)	方法偵測 極限值 (MDL)	結果 (Result)
				NO.1
<b>多溴聯苯總和 / Sum of PBBs</b>	mg/kg	參考IEC 62321: 2008方法, 以氣相層析儀/質譜儀檢測. / With reference to IEC 62321: 2008 and performed by GC/MS.	-	n.d.
一溴聯苯 / Monobromobiphenyl			5	n.d.
二溴聯苯 / Dibromobiphenyl			5	n.d.
三溴聯苯 / Tribromobiphenyl			5	n.d.
四溴聯苯 / Tetrabromobiphenyl			5	n.d.
五溴聯苯 / Pentabromobiphenyl			5	n.d.
六溴聯苯 / Hexabromobiphenyl			5	n.d.
七溴聯苯 / Heptabromobiphenyl			5	n.d.
八溴聯苯 / Octabromobiphenyl			5	n.d.
九溴聯苯 / Nonabromobiphenyl			5	n.d.
十溴聯苯 / Decabromobiphenyl			5	n.d.
<b>多溴聯苯醚總和 / Sum of PBDEs</b>	mg/kg	參考IEC 62321: 2008方法, 以氣相層析儀/質譜儀檢測. / With reference to IEC 62321: 2008 and performed by GC/MS.	-	n.d.
一溴聯苯醚 / Monobromodiphenyl ether			5	n.d.
二溴聯苯醚 / Dibromodiphenyl ether			5	n.d.
三溴聯苯醚 / Tribromodiphenyl ether			5	n.d.
四溴聯苯醚 / Tetrabromodiphenyl ether			5	n.d.
五溴聯苯醚 / Pentabromodiphenyl ether			5	n.d.
六溴聯苯醚 / Hexabromodiphenyl ether			5	n.d.
七溴聯苯醚 / Heptabromodiphenyl ether			5	n.d.
八溴聯苯醚 / Octabromodiphenyl ether			5	n.d.
九溴聯苯醚 / Nonabromodiphenyl ether			5	n.d.
十溴聯苯醚 / Decabromodiphenyl ether			5	n.d.

Unless otherwise stated the results shown in this test report refer only to the sample(s) tested. This test report cannot be reproduced, except in full, without prior written permission of the Company. 除非另有說明, 此報告結果僅對測試之樣品負責。本報告未經本公司書面許可, 不可部分複製。  
This document is issued by the Company subject to its General Conditions of Service printed overleaf, available on request or accessible at [www.sgs.com/terms\\_and\\_conditions.htm](http://www.sgs.com/terms_and_conditions.htm) and, for electronic format documents, subject to Terms and Conditions for Electronic Documents at [www.sgs.com/terms\\_e-document.htm](http://www.sgs.com/terms_e-document.htm). Attention is drawn to the limitation of liability, indemnification and jurisdiction issues defined therein. Any holder of this document is advised that information contained hereon reflects the Company's findings at the time of its intervention only and within the limits of Client's instructions, if any. The Company's sole responsibility is to its Client and this document does not exonerate parties to a transaction from exercising all their rights and obligations under the transaction documents. This document cannot be reproduced except in full, without prior written approval of the Company. Any unauthorized alteration, forgery or falsification of the content or appearance of this document is unlawful and offenders may be prosecuted to the fullest extent of the law.

# 測試報告 Test Report

號碼(No.) : KA/2014/C2296 日期(Date) : 2015/01/05 頁數(Page) : 4 of 8

旗欣股份有限公司  
EVER CONNECTOR INDUSTRIAL CO., LTD  
高雄市岡山區本洲路91巷1號  
NO.1 LANE 91 PEN CHOU RD. KANGSHAN KAOHSIUNG CITY TAIWAN R.O.C.

## 備註(Note) :

1. mg/kg = ppm ; 0.1wt% = 1000ppm
2. n.d. = Not Detected (未檢出)
3. MDL = Method Detection Limit (方法偵測極限值)
4. "-" = Not Regulated (無規格值)
5. \*\*= Qualitative analysis (No Unit) 定性分析(無單位)
6. # =
  - a. Positive means the presence of CrVI on the tested areas  
(Positive表示測試區域偵測到六價鉻)
  - b. Negative means the absence of CrVI on the tested areas  
(Negative表示測試區域未偵測到六價鉻)

The detected concentration in boiling-water-extraction solution is equal or greater than 0.02 mg/kg with 50 cm<sup>2</sup> tested areas . /  
該溶液濃度 $\geq$ 0.02 mg/kg with 50 cm<sup>2</sup> (tested areas)

7. 樣品的測試是基於申請人要求混合測試，報告中的混合測試結果不代表其中個別單一材質的含量。  
(The samples was/were analyzed on behalf of the applicant as mixing sample in one testing.  
The above results was/were only given as the informality value.)

## PFOS參考資訊(Reference Information) : 持久性有機污染物 POPs - (EU) 757/2010

PFOS濃度在物質或製備中不得超過0.001%(10ppm)，在半成品、成品或零部件中不得超過0.1%(1000ppm)，在紡織品或塗層材料中不得超過1 $\mu$ g/m<sup>2</sup>。(Outlawing PFOS as substances or preparations in concentrations above 0.001% (10ppm), in semi-finished products or articles or parts at a level above 0.1%(1000ppm), in textiles or other coated materials above 1 $\mu$ g/m<sup>2</sup>.)

Unless otherwise stated the results shown in this test report refer only to the sample(s) tested. This test report cannot be reproduced, except in full, without prior written permission of the Company. 除非另有說明，此報告結果僅對測試之樣品負責。本報告未經本公司書面許可，不可部分複製。  
This document is issued by the Company subject to its General Conditions of Service printed overleaf, available on request or accessible at [www.sgs.com/terms\\_and\\_conditions.htm](http://www.sgs.com/terms_and_conditions.htm) and, for electronic format documents, subject to Terms and Conditions for Electronic Documents at [www.sgs.com/terms\\_e-document.htm](http://www.sgs.com/terms_e-document.htm). Attention is drawn to the limitation of liability, indemnification and jurisdiction issues defined therein. Any holder of this document is advised that information contained hereon reflects the Company's findings at the time of its intervention only and within the limits of Client's instructions, if any. The Company's sole responsibility is to its Client and this document does not exonerate parties to a transaction from exercising all their rights and obligations under the transaction documents. This document cannot be reproduced except in full, without prior written approval of the Company. Any unauthorized alteration, forgery or falsification of the content or appearance of this document is unlawful and offenders may be prosecuted to the fullest extent of the law.

## 測試報告 Test Report

號碼(No.) : KA/2014/C2296 日期(Date) : 2015/01/05 頁數(Page) : 5 of 8

旗欣股份有限公司

EVER CONNECTOR INDUSTRIAL CO., LTD

高雄市岡山區本洲路91巷1號

NO.1 LANE 91 PEN CHOU RD. KANGSHAN KAOHSIUNG CITY TAIWAN R.O.C.

- 1) 根據以下的流程圖之條件，樣品已完全溶解。(六價鉻測試方法除外) / These samples were dissolved totally by pre-conditioning method according to below flow chart. (Cr<sup>6+</sup> test method excluded)
- 2) 測試人員：劉俊宏 / Name of the person who made measurement: Jony Liu
- 3) 測試負責人：張伯睿 / Name of the person in charge of measurement: Ray Chang

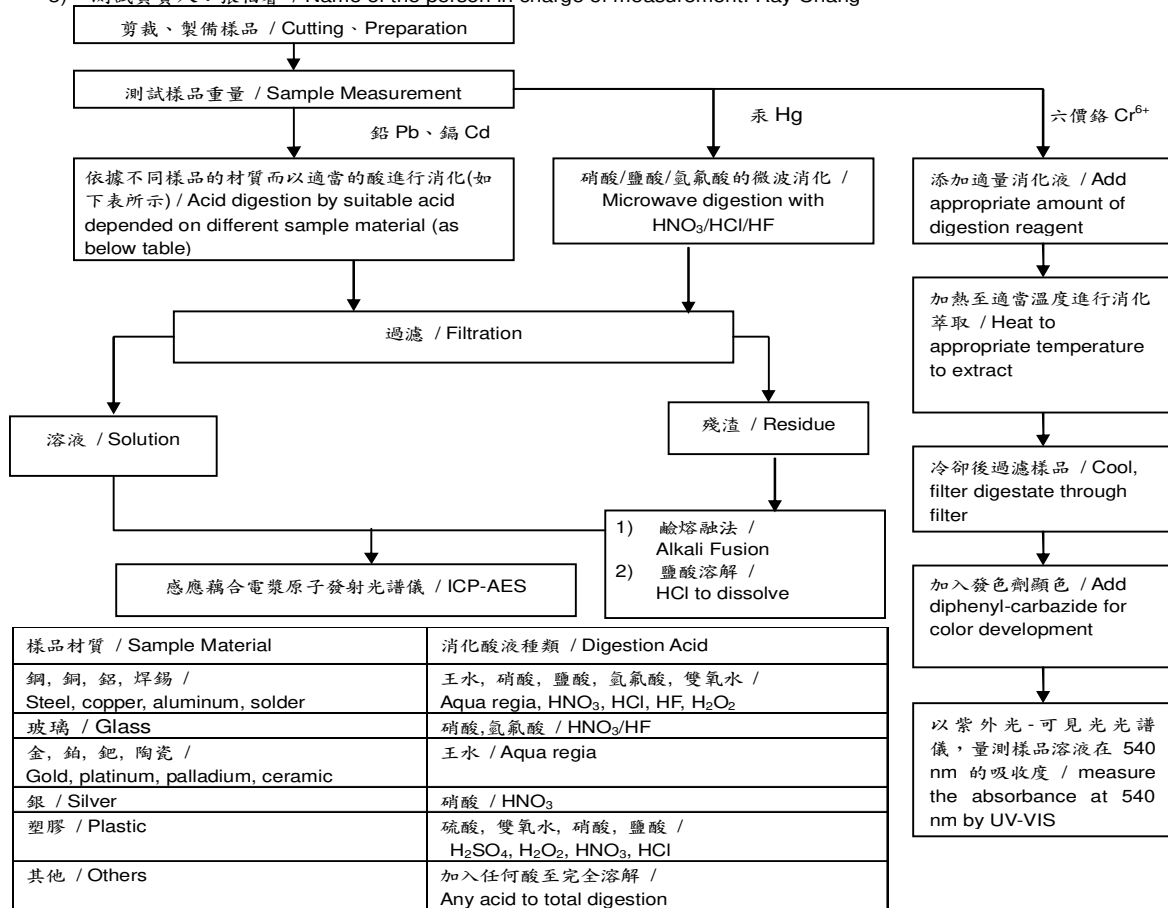

- Note\*\* :** (1) 針對非金屬材料加入鹼性消化液，加熱至 90~95°C 萃取。 / For non-metallic material, add alkaline digestion reagent and heat to 90~95°C .
- (2) 針對金屬材料加入純水，加熱至沸騰萃取。 / For metallic material, add pure water and heat to boiling.

Unless otherwise stated the results shown in this test report refer only to the sample(s) tested. This test report cannot be reproduced, except in full, without prior written permission of the Company. 除非另有說明，此報告結果僅對測試之樣品負責。本報告未經本公司書面許可，不可部分複製。 This document is issued by the Company subject to its General Conditions of Service printed overleaf, available on request or accessible at [www.sgs.com/terms\\_and\\_conditions.htm](http://www.sgs.com/terms_and_conditions.htm) and, for electronic format documents, subject to Terms and Conditions for Electronic Documents at [www.sgs.com/terms\\_e-document.htm](http://www.sgs.com/terms_e-document.htm). Attention is drawn to the limitation of liability, indemnification and jurisdiction issues defined therein. Any holder of this document is advised that information contained hereon reflects the Company's findings at the time of its intervention only and within the limits of Client's instructions, if any. The Company's sole responsibility is to its Client and this document does not exonerate parties to a transaction from exercising all their rights and obligations under the transaction documents. This document cannot be reproduced except in full, without prior written approval of the Company. Any unauthorized alteration, forgery or falsification of the content or appearance of this document is unlawful and offenders may be prosecuted to the fullest extent of the law.

# 測試報告 Test Report

號碼(No.) : KA/2014/C2296 日期(Date) : 2015/01/05 頁數(Page) : 6 of 8

旗欣股份有限公司  
EVER CONNECTOR INDUSTRIAL CO., LTD  
高雄市岡山區本洲路91巷1號  
NO.1 LANE 91 PEN CHOU RD. KANGSHAN KAOHSIUNG CITY TAIWAN R.O.C.

## 多溴聯苯/多溴聯苯醚 分析流程圖 / PBB/PBDE analytical FLOW CHART

- 1) 測試人員：陳威錚 / Name of the person who made measurement: Dorothy Chen  
2) 測試負責人：張伯睿 / Name of the person in charge of measurement: Ray Chang

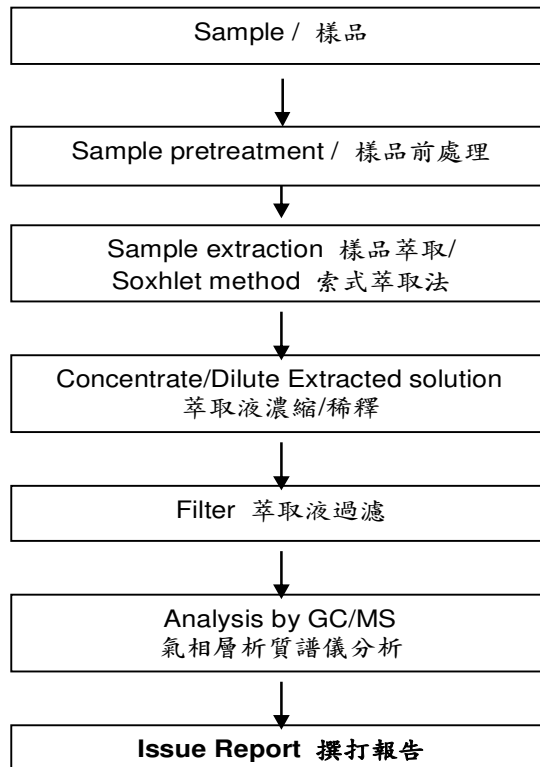

Unless otherwise stated the results shown in this test report refer only to the sample(s) tested. This test report cannot be reproduced, except in full, without prior written permission of the Company. 除非另有說明，此報告結果僅對測試之樣品負責。本報告未經本公司書面許可，不可部分複製。  
This document is issued by the Company subject to its General Conditions of Service printed overleaf, available on request or accessible at [www.sgs.com/terms\\_and\\_conditions.htm](http://www.sgs.com/terms_and_conditions.htm) and, for electronic format documents, subject to Terms and Conditions for Electronic Documents at [www.sgs.com/terms\\_e-document.htm](http://www.sgs.com/terms_e-document.htm). Attention is drawn to the limitation of liability, indemnification and jurisdiction issues defined therein. Any holder of this document is advised that information contained hereon reflects the Company's findings at the time of its intervention only and within the limits of Client's instructions, if any. The Company's sole responsibility is to its Client and this document does not exonerate parties to a transaction from exercising all their rights and obligations under the transaction documents. This document cannot be reproduced except in full, without prior written approval of the Company. Any unauthorized alteration, forgery or falsification of the content or appearance of this document is unlawful and offenders may be prosecuted to the fullest extent of the law.

# 測試報告 Test Report

號碼(No.) : KA/2014/C2296 日期(Date) : 2015/01/05 頁數(Page) : 7 of 8

旗欣股份有限公司  
EVER CONNECTOR INDUSTRIAL CO., LTD  
高雄市岡山區本洲路91巷1號  
NO.1 LANE 91 PEN CHOU RD. KANGSHAN KAOHSIUNG CITY TAIWAN R.O.C.

## 全氟辛酸(銨)/ 全氟辛烷磺酸分析流程圖 / Analytical flow chart of PFOA/PFOS content

- 1) 測試人員：黃璟璿 / Name of the person who made measurement: Ginny Huang  
2) 測試負責人：張伯睿 / Name of the person in charge of measurement: Ray Chang

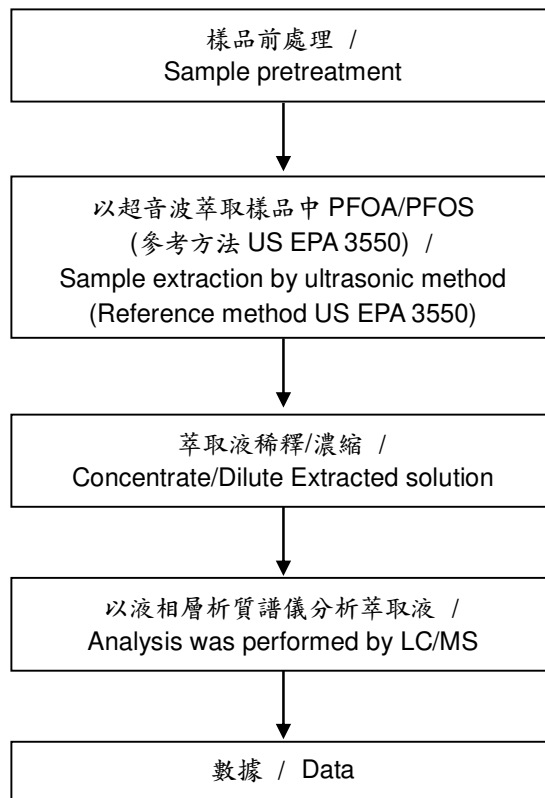

Unless otherwise stated the results shown in this test report refer only to the sample(s) tested. This test report cannot be reproduced, except in full, without prior written permission of the Company. 除非另有說明，此報告結果僅對測試之樣品負責。本報告未經本公司書面許可，不可部分複製。  
This document is issued by the Company subject to its General Conditions of Service printed overleaf, available on request or accessible at [www.sgs.com/terms\\_and\\_conditions.htm](http://www.sgs.com/terms_and_conditions.htm) and, for electronic format documents, subject to Terms and Conditions for Electronic Documents at [www.sgs.com/terms\\_e-document.htm](http://www.sgs.com/terms_e-document.htm). Attention is drawn to the limitation of liability, indemnification and jurisdiction issues defined therein. Any holder of this document is advised that information contained hereon reflects the Company's findings at the time of its intervention only and within the limits of Client's instructions, if any. The Company's sole responsibility is to its Client and this document does not exonerate parties to a transaction from exercising all their rights and obligations under the transaction documents. This document cannot be reproduced except in full, without prior written approval of the Company. Any unauthorized alteration, forgery or falsification of the content or appearance of this document is unlawful and offenders may be prosecuted to the fullest extent of the law.



## 測試報告 Test Report

號碼(No.) : KA/2014/C2296 日期(Date) : 2015/01/05 頁數(Page) : 8 of 8

旗欣股份有限公司

EVER CONNECTOR INDUSTRIAL CO., LTD

高雄市岡山區本洲路91巷1號

NO.1 LANE 91 PEN CHOU RD. KANGSHAN KAOHSIUNG CITY TAIWAN R.O.C.

\* 照片中如有箭頭標示，則表示為實際檢測之樣品/部位。\*

(The tested sample / part is marked by an arrow if it's shown on the photo.)

## KA/2014/C2296



\*\* 報告結尾(End of Report) \*\*

Unless otherwise stated the results shown in this test report refer only to the sample(s) tested. This test report cannot be reproduced, except in full, without prior written permission of the Company. 除非另有說明，此報告結果僅對測試之樣品負責。本報告未經本公司書面許可，不可部分複製。  
This document is issued by the Company subject to its General Conditions of Service printed overleaf, available on request or accessible at [www.sgs.com/terms\\_and\\_conditions.htm](http://www.sgs.com/terms_and_conditions.htm) and, for electronic format documents, subject to Terms and Conditions for Electronic Documents at [www.sgs.com/terms\\_e-document.htm](http://www.sgs.com/terms_e-document.htm). Attention is drawn to the limitation of liability, indemnification and jurisdiction issues defined therein. Any holder of this document is advised that information contained hereon reflects the Company's findings at the time of its intervention only and within the limits of Client's instructions, if any. The Company's sole responsibility is to its Client and this document does not exonerate parties to a transaction from exercising all their rights and obligations under the transaction documents. This document cannot be reproduced except in full, without prior written approval of the Company. Any unauthorized alteration, forgery or falsification of the content or appearance of this document is unlawful and offenders may be prosecuted to the fullest extent of the law.

# 东莞市千岛金属锡品有限公司

Thousand Island Metal Foil Co.,Ltd.

## 产品检验报告书

产品名称	无铅锡线 A		样品规格	Sn99.3/Cu0.7			检验依据	GB/T3131-2001		
生产日期		2009-02-08			试样编号		NO.2008121333A			
序号	检测项目		技术要求		检测样品数		检测结果		单项结论	
1	外表质量		光亮平整		各一个		光亮平整		合格	
2	尺寸 (mm)		Ø1.0±0.02		5 米		1.0		合格	
3	熔点 (°C)		220-230		1KG		227		合格	
4	电阻率 (Ωcm <sup>2</sup> /m)		≤0.177		3 米		0.05		合格	
5	焊剂含量 (%)		1.5-1.7		3 米		1.62		合格	
6	扩展率 (%)		>85		3 米		96		合格	
7	干燥度		粉末易去		5 块		粉末易去		合格	
8	绝缘电阻 (Ω)		≥10 <sup>11</sup>		5 块		10 <sup>11</sup>		合格	
9	PH 值		6-7		3 次		6.7		合格	
10	焊锡环		不飞溅		5 块		不飞溅		合格	
11	铜镜试验		无穿透性腐蚀		3 块		不腐蚀		合格	
检验依据 (GB/T3131)	元素名称	Sn	Cu	Pb	Bi	As	Sb	Zn	Al	Fe
	合金成份 (wt%)	99.0-99.6	0.65-0.75	0.01	0.01	0.02	0.05	0.005	0.005	0.02
	实测结果	99.3	0.69	0.0009	0.0007	0.0028	0.0013	0.0007	0.0006	0.008
	单项结论	合格	合格	合格	合格	合格	合格	合格	合格	合格
检验结论	<p>经检测,所有项目都符合标准要求。</p> <p style="text-align: right;">千岛金属锡品有限公司</p>									
签名	主 检			编 制			批 准			
	黄信元			熊 慧			刘曙光			
日期	2009 年 02 月 08 日			2009 年 02 月 08 日			2009 年 02 月 08 日			

## Test Report

No. CANEC1417822706

Date: 06 Nov 2014

Page 1 of 8

THOUSAND ISLAND METAL FOIL CO., LTD

BLOCK FIFTEEN NEW SUN INDUSTRIAL AREA TANGXIA TOWN,DONGGUAN CITY

The following sample(s) was/were submitted and identified on behalf of the clients as : Solder wire Sn99.3Cu0.7

SGS Job No. : CP14-057422 - SZ

Model No. : 107

Client Ref. Info. : 107H

Date of Sample Received : 30 Oct 2014

Testing Period : 30 Oct 2014 - 05 Nov 2014

Test Requested : Selected test(s) as requested by client.

Test Method : Please refer to next page(s).

Test Results : Please refer to next page(s).

Conclusion : Based on the performed tests on submitted sample(s), the results of Lead, Mercury, Cadmium, Hexavalent chromium, Polybrominated biphenyls (PBBs), Polybrominated diphenyl ethers (PBDEs) comply with the limits as set by RoHS Directive 2011/65/EU Annex II; recasting 2002/95/EC.

Signed for and on behalf of  
SGS-CSTC Ltd.

*Yan*

Yan Lee

Approved Signatory



This document is issued by the Company subject to its General Conditions of Service printed overleaf, available on request or accessible at <http://www.sgs.com/en/Terms-and-Conditions.aspx> and, for electronic format documents, subject to Terms and Conditions for Electronic Documents at <http://www.sgs.com/en/Terms-and-Conditions/Terms-e-Documents.aspx>. Attention is drawn to the limitation of liability, indemnification and jurisdiction issues defined therein. Any holder of this document is advised that information contained hereon reflects the Company's findings at the time of its intervention only and within the limits of Client's instructions, if any. The Company's sole responsibility is to its Client and this document does not exonerate parties to a transaction from exercising all their rights and obligations under the transaction documents. This document cannot be reproduced except in full, without prior written approval of the Company. Any unauthorized alteration, forgery or falsification of the content or appearance of this document is unlawful and offenders may be prosecuted to the fullest extent of the law. Unless otherwise stated the results shown in this test report refer only to the sample(s) tested.

Attention: To check the authenticity of testing /inspection report & certificate, please contact us at telephone: (86-755) 8307 1443, or email: [CN.Doccheck@sgs.com](mailto:CN.Doccheck@sgs.com)

198 Kezhu Road, Sciencetech Park Guangzhou Economic & Technology Development District, Guangzhou, China 510663 t (86-20) 82155555 f (86-20) 82075113 www.sgsgroup.com.cn  
中国·广州·经济技术开发区科学城科珠路198号 邮编: 510663 t (86-20) 82155555 f (86-20) 82075113 e [sgs.china@sgs.com](mailto:sgs.china@sgs.com)

# Test Report

No. CANEC1417822706

Date: 06 Nov 2014

Page 2 of 8

Test Results :

Test Part Description :

Specimen No.	SGS Sample ID	Description
SN1	CAN14-178227.006	Silvery metal wire

Remarks :

- (1) 1 mg/kg = 1 ppm = 0.0001%
- (2) MDL = Method Detection Limit
- (3) ND = Not Detected ( < MDL )
- (4) "-" = Not Regulated

**RoHS Directive 2011/65/EU**

- Test Method :
- (1)With reference to IEC 62321-5:2013, determination of Cadmium by ICP-OES.
  - (2)With reference to IEC 62321-5:2013, determination of Lead by ICP-OES.
  - (3)With reference to IEC 62321-4:2013, determination of Mercury by ICP-OES.
  - (4)With reference to IEC 62321:2008, determination of Hexavalent Chromium by spot test / Colorimetric Method using UV-Vis.
  - (5)With reference to IEC 62321:2008, determination of PBBs and PBDEs by GC-MS.

<u>Test Item(s)</u>	<u>Limit</u>	<u>Unit</u>	<u>MDL</u>	<u>006</u>
Cadmium (Cd)	100	mg/kg	2	ND
Lead (Pb)	1,000	mg/kg	2	46
Mercury (Hg)	1,000	mg/kg	2	ND
Hexavalent Chromium (CrVI)	-	-	◇	Negative
Sum of PBBs	1,000	mg/kg	-	ND
Monobromobiphenyl	-	mg/kg	5	ND
Dibromobiphenyl	-	mg/kg	5	ND
Tribromobiphenyl	-	mg/kg	5	ND
Tetrabromobiphenyl	-	mg/kg	5	ND
Pentabromobiphenyl	-	mg/kg	5	ND
Hexabromobiphenyl	-	mg/kg	5	ND
Heptabromobiphenyl	-	mg/kg	5	ND
Octabromobiphenyl	-	mg/kg	5	ND
Nonabromobiphenyl	-	mg/kg	5	ND
Decabromobiphenyl	-	mg/kg	5	ND
Sum of PBDEs	1,000	mg/kg	-	ND
Monobromodiphenyl ether	-	mg/kg	5	ND



This document is issued by the Company subject to its General Conditions of Service printed overleaf, available on request or accessible at <http://www.sgs.com/en/Terms-and-Conditions.aspx> and, for electronic format documents, subject to Terms and Conditions for Electronic Documents at <http://www.sgs.com/en/Terms-and-Conditions/Terms-e-Documents.aspx>. Attention is drawn to the limitation of liability, indemnification and jurisdiction issues defined therein. Any holder of this document is advised that information contained hereon reflects the Company's findings at the time of its intervention only and within the limits of Client's instructions, if any. The Company's sole responsibility is to its Client and this document does not exonerate parties to a transaction from exercising all their rights and obligations under the transaction documents. This document cannot be reproduced except in full, without prior written approval of the Company. Any unauthorized alteration, forgery or falsification of the content or appearance of this document is unlawful and offenders may be prosecuted to the fullest extent of the law. Unless otherwise stated the results shown in this test report refer only to the sample(s) tested.

Attention: To check the authenticity of testing /inspection report & certificate, please contact us at telephone: (86-755) 8307 1443, or email: CN.Doccheck@sgs.com

198 Kezhu Road, Sciencetech Park Guangzhou Economic & Technology Development District, Guangzhou, China 510663 t (86-20) 82155555 f (86-20) 82075113 www.sgsgroup.com.cn  
中国·广州·经济技术开发区科学城科珠路198号 邮编: 510663 t (86-20) 82155555 f (86-20) 82075113 e sgs.china@sgs.com

## Test Report

No. CANEC1417822706

Date: 06 Nov 2014

Page 3 of 8

<u>Test Item(s)</u>	<u>Limit</u>	<u>Unit</u>	<u>MDL</u>	<u>006</u>
Dibromodiphenyl ether	-	mg/kg	5	ND
Tribromodiphenyl ether	-	mg/kg	5	ND
Tetrabromodiphenyl ether	-	mg/kg	5	ND
Pentabromodiphenyl ether	-	mg/kg	5	ND
Hexabromodiphenyl ether	-	mg/kg	5	ND
Heptabromodiphenyl ether	-	mg/kg	5	ND
Octabromodiphenyl ether	-	mg/kg	5	ND
Nonabromodiphenyl ether	-	mg/kg	5	ND
Decabromodiphenyl ether	-	mg/kg	5	ND

### Notes :

(1) The maximum permissible limit is quoted from the directive 2011/65/EU, Annex II

(2)◇Spot-test:

Negative = Absence of CrVI coating, Positive = Presence of CrVI coating;

(The tested sample should be further verified by boiling-water-extraction method if the spot test result is Negative or cannot be confirmed.)

◇Boiling-water-extraction:

Negative = Absence of CrVI coating

Positive = Presence of CrVI coating; the detected concentration in boiling-water-extraction solution is equal or greater than 0.02 mg/kg with 50 cm<sup>2</sup> sample surface area.

Information on storage conditions and production date of the tested sample is unavailable and thus results of Cr(VI) represent status of the sample at the time of testing.

### Hexabromocyclododecane (HBCDD)

Test Method : Determination of HBCDD by GC-MS based on IEC 62321:2008.

<u>Test Item(s)</u>	<u>Unit</u>	<u>MDL</u>	<u>006</u>
Hexabromocyclododecane (HBCDD)	mg/kg	10	ND

### Notes :

(1) Reference Information: Directive 2011/65/EU recasting RoHS directive 2002/95/EC:

Hexabromocyclododecane (HBCDD) is considered as a priority for risk evaluation and substance restriction.

### Phthalate

Test Method : Determination of phthalates by GC-MS based on EN 14372:2004.



This document is issued by the Company subject to its General Conditions of Service printed overleaf, available on request or accessible at <http://www.sgs.com/en/Terms-and-Conditions.aspx> and, for electronic format documents, subject to Terms and Conditions for Electronic Documents at <http://www.sgs.com/en/Terms-and-Conditions/Terms-e-Documents.aspx>. Attention is drawn to the limitation of liability, indemnification and jurisdiction issues defined therein. Any holder of this document is advised that information contained hereon reflects the Company's findings at the time of its intervention only and within the limits of Client's instructions, if any. The Company's sole responsibility is to its Client and this document does not exonerate parties to a transaction from exercising all their rights and obligations under the transaction documents. This document cannot be reproduced except in full, without prior written approval of the Company. Any unauthorized alteration, forgery or falsification of the content or appearance of this document is unlawful and offenders may be prosecuted to the fullest extent of the law. Unless otherwise stated the results shown in this test report refer only to the sample(s) tested.

Attention: To check the authenticity of testing / inspection report & certificate, please contact us at telephone: (86-755) 8307 1443, or email: CN.Doccheck@sgs.com

SGS-CTI Standards Technical Services Co., Ltd.  
Guangzhou Chemical Laboratory

198 Kezhu Road, Sciencetech Park Guangzhou Economic & Technology Development District, Guangzhou, China 510663 t (86-20) 82155555 f (86-20) 82075113 www.sgsgroup.com.cn  
中国·广州·经济技术开发区科学城科珠路198号 邮编: 510663 t (86-20) 82155555 f (86-20) 82075113 e sgs.china@sgs.com

## Test Report

No. CANEC1417822706

Date: 06 Nov 2014

Page 4 of 8

<u>Test Item(s)</u>	<u>CAS NO.</u>	<u>Unit</u>	<u>MDL</u>	<u>006</u>
Dibutyl Phthalate (DBP)	84-74-2	%(w/w)	0.003	ND
Benzylbutyl Phthalate (BBP)	85-68-7	%(w/w)	0.003	ND
Bis(2-ethylhexyl) Phthalate (DEHP)	117-81-7	%(w/w)	0.003	ND

### Notes :

- (1) Reference Information: Directive 2011/65/EU recasting RoHS directive 2002/95/EC:  
Bis (2-ethylhexyl) phthalate (DEHP), Butyl benzyl phthalate (BBP) and Dibutyl phthalate (DBP) are considered as a priority for risk evaluation and substance restriction.



This document is issued by the Company subject to its General Conditions of Service printed overleaf, available on request or accessible at <http://www.sgs.com/en/Terms-and-Conditions.aspx> and, for electronic format documents, subject to Terms and Conditions for Electronic Documents at <http://www.sgs.com/en/Terms-and-Conditions/Terms-e-Documents.aspx>. Attention is drawn to the limitation of liability, indemnification and jurisdiction issues defined therein. Any holder of this document is advised that information contained hereon reflects the Company's findings at the time of its intervention only and within the limits of Client's instructions, if any. The Company's sole responsibility is to its Client and this document does not exonerate parties to a transaction from exercising all their rights and obligations under the transaction documents. This document cannot be reproduced except in full, without prior written approval of the Company. Any unauthorized alteration, forgery or falsification of the content or appearance of this document is unlawful and offenders may be prosecuted to the fullest extent of the law. Unless otherwise stated the results shown in this test report refer only to the sample(s) tested.

Attention: To check the authenticity of testing /inspection report & certificate, please contact us at telephone: (86-755) 8307 1443, or email: [CN.Doccheck@sgs.com](mailto:CN.Doccheck@sgs.com)

SGS-CTI Standards Technical Services Co., Ltd.  
Guangzhou Chemical Laboratory

198 Kezhu Road, Sciencetech Park Guangzhou Economic & Technology Development District, Guangzhou, China 510663 t (86-20) 82155555 f (86-20) 82075113 www.sgsgroup.com.cn  
中国·广州·经济技术开发区科学城科珠路198号 邮编: 510663 t (86-20) 82155555 f (86-20) 82075113 e [sgs.china@sgs.com](mailto:sgs.china@sgs.com)



ATTACHMENTS

RoHS Testing Flow Chart

- 1) Name of the person who made testing: Bruce Xiao / Sunny Hu
- 2) Name of the person in charge of testing: Bella Wang / Cutey Yu
- 3) These samples were dissolved totally by pre-conditioning method according to below flow chart (Cr<sup>6+</sup> and PBBs/PBDEs test method excluded).

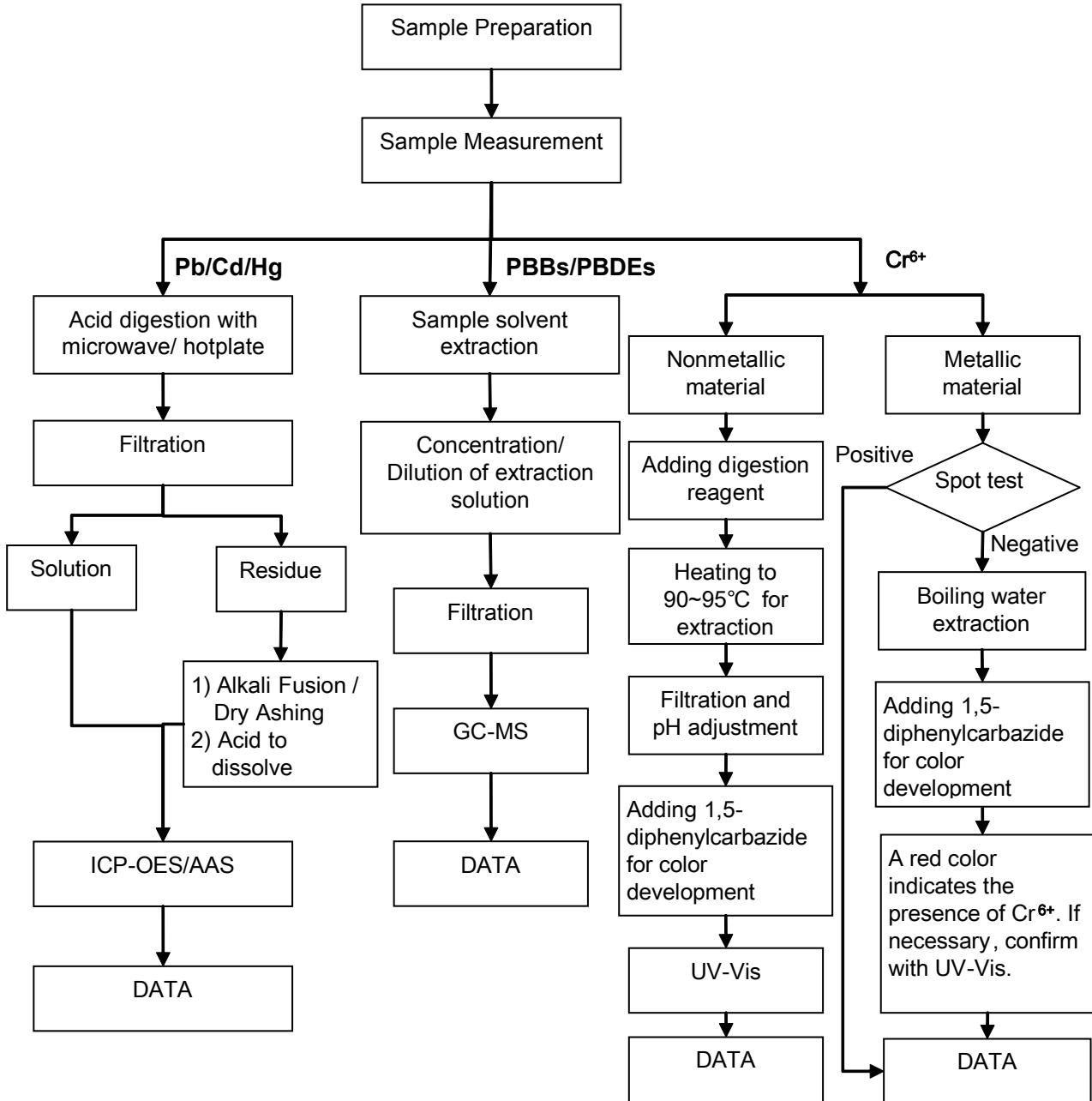

This document is issued by the Company subject to its General Conditions of Service printed overleaf, available on request or accessible at <http://www.sgs.com/en/Terms-and-Conditions.aspx> and, for electronic format documents, subject to Terms and Conditions for Electronic Documents at <http://www.sgs.com/en/Terms-and-Conditions/Terms-e-Documents.aspx>. Attention is drawn to the limitation of liability, indemnification and jurisdiction issues defined therein. Any holder of this document is advised that information contained herein reflects the Company's findings at the time of its intervention only and within the limits of Client's instructions, if any. The Company's sole responsibility is to its Client and this document does not exonerate parties to a transaction from exercising all their rights and obligations under the transaction documents. This document cannot be reproduced except in full, without prior written approval of the Company. Any unauthorized alteration, forgery or falsification of the content or appearance of this document is unlawful and offenders may be prosecuted to the fullest extent of the law. Unless otherwise stated the results shown in this test report refer only to the sample(s) tested.

Attention: To check the authenticity of testing / inspection report & certificate, please contact us at telephone: (86-755) 8307 1443, or email: CN.Doccheck@sgs.com

198 Kezhu Road, Sciencetech Park Guangzhou Economic & Technology Development District, Guangzhou, China 510663 t (86-20) 82155555 f (86-20) 82075113 www.sgsgroup.com.cn  
中国·广州·经济技术开发区科学城科珠路198号 邮编: 510663 t (86-20) 82155555 f (86-20) 82075113 e sgs.china@sgs.com

ATTACHMENTS

HBCDD Testing Flow Chart

- 1) Name of the person who made testing: Sunny Hu
- 2) Name of the person in charge of testing: Cutey Yu

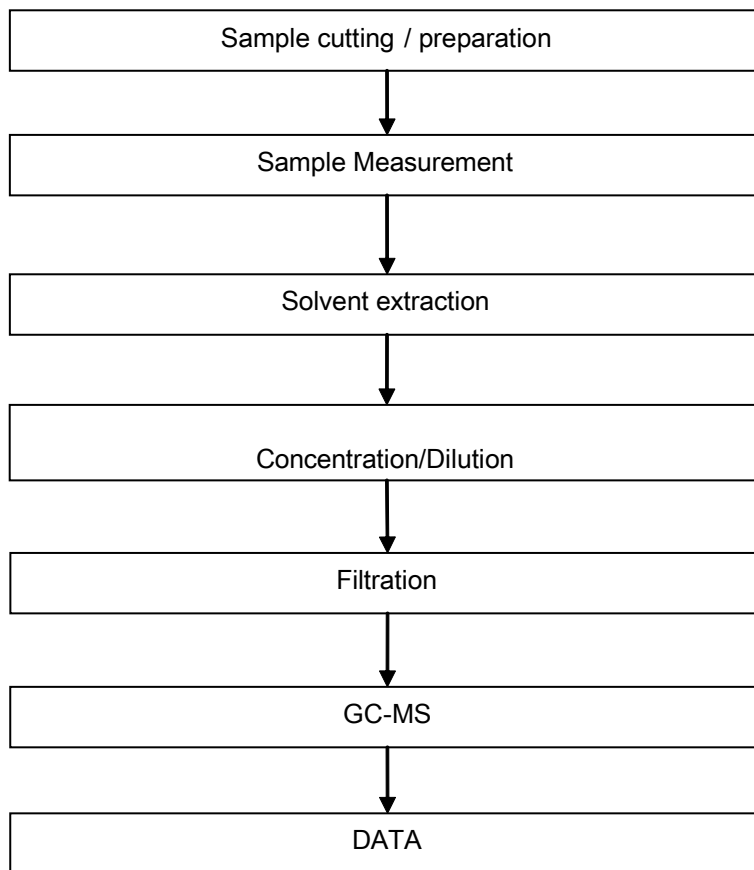

This document is issued by the Company subject to its General Conditions of Service printed overleaf, available on request or accessible at <http://www.sgs.com/en/Terms-and-Conditions.aspx> and, for electronic format documents, subject to Terms and Conditions for Electronic Documents at <http://www.sgs.com/en/Terms-and-Conditions/Terms-e-Documents.aspx>. Attention is drawn to the limitation of liability, indemnification and jurisdiction issues defined therein. Any holder of this document is advised that information contained hereon reflects the Company's findings at the time of its intervention only and within the limits of Client's instructions, if any. The Company's sole responsibility is to its Client and this document does not exonerate parties to a transaction from exercising all their rights and obligations under the transaction documents. This document cannot be reproduced except in full, without prior written approval of the Company. Any unauthorized alteration, forgery or falsification of the content or appearance of this document is unlawful and offenders may be prosecuted to the fullest extent of the law. Unless otherwise stated the results shown in this test report refer only to the sample(s) tested.

Attention: To check the authenticity of testing / inspection report & certificate, please contact us at telephone: (86-755) 8307 1443, or email: [CN.Doccheck@sgs.com](mailto:CN.Doccheck@sgs.com)

198 Kezhu Road, Sciencetech Park Guangzhou Economic & Technology Development District, Guangzhou, China 510663 t (86-20) 82155555 f (86-20) 82075113 www.sgsgroup.com.cn  
 中国·广州·经济技术开发区科学城科珠路198号 邮编: 510663 t (86-20) 82155555 f (86-20) 82075113 e [sgs.china@sgs.com](mailto:sgs.china@sgs.com)

ATTACHMENTS

Phthalates Testing Flow Chart

- 1) Name of the person who made testing: Sunny Hu
- 2) Name of the person in charge of testing: Cutey Yu

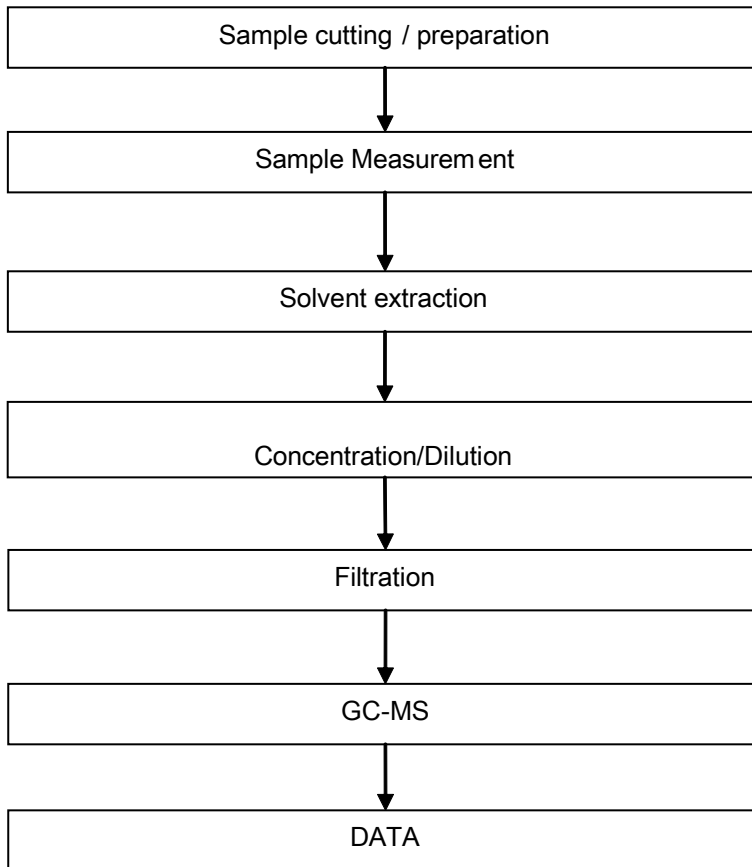

This document is issued by the Company subject to its General Conditions of Service printed overleaf, available on request or accessible at <http://www.sgs.com/en/Terms-and-Conditions.aspx> and, for electronic format documents, subject to Terms and Conditions for Electronic Documents at <http://www.sgs.com/en/Terms-and-Conditions/Terms-e-Documents.aspx>. Attention is drawn to the limitation of liability, indemnification and jurisdiction issues defined therein. Any holder of this document is advised that information contained hereon reflects the Company's findings at the time of its intervention only and within the limits of Client's instructions, if any. The Company's sole responsibility is to its Client and this document does not exonerate parties to a transaction from exercising all their rights and obligations under the transaction documents. This document cannot be reproduced except in full, without prior written approval of the Company. Any unauthorized alteration, forgery or falsification of the content or appearance of this document is unlawful and offenders may be prosecuted to the fullest extent of the law. Unless otherwise stated the results shown in this test report refer only to the sample(s) tested.

Attention: To check the authenticity of testing / inspection report & certificate, please contact us at telephone: (86-755) 8307 1443, or email: [CN.Doccheck@sgs.com](mailto:CN.Doccheck@sgs.com)

198 Kezhu Road, Sciencetech Park Guangzhou Economic & Technology Development District, Guangzhou, China 510663 t (86-20) 82155555 f (86-20) 82075113 www.sgsgroup.com.cn  
 中国·广州·经济技术开发区科学城科珠路198号 邮编: 510663 t (86-20) 82155555 f (86-20) 82075113 e [sgs.china@sgs.com](mailto:sgs.china@sgs.com)

Sample photo:



SGS authenticate the photo on original report only

\*\*\* End of Report \*\*\*

# 材 料 成 分 表

公司名称：展兴机械有限公司

兹证明提供 公司：热缩套管

由以下主要材料成分组成：

原材料名称	总比例	原材料产地	原材料制造供应商	物质1		物质2		物质3		物质4		物质5		物质6	
				名称	构成比率	名称	构成比率	名称	构成比率	名称	构成比率	名称	构成比率	名称	构成比率
PE	70%	北京	北京有机	EVA	100%										
阻燃剂	15%	山西	山西铝粉	AL(OH)3	99%										
阻燃剂	13%	佛山	佛山金戈	Mg(OH)2	99%										
色母粒	2%	四川	成都新彩	PE	70%	色粉	30%								

## Test Report

No. CANEC1505019605

Date: 13 Apr 2015

Page 1 of 9

SHENZHEN WOER HEAT-SHRINKABLE MATERIAL CO.,LTD.

WOER MANSION,LANJING NORTH ROAD,PINGSHAN INDUSTRIAL ZONE, LONGGANG DISTRICT, SHENZHEN CHINA

The following sample(s) was/were submitted and identified on behalf of the clients as : H-CLEAR RSFR HEAT SHRINKABLE TUBINGS

SGS Job No. : CP15-017309 - SZ

Date of Sample Received : 07 Apr 2015

Testing Period : 07 Apr 2015 - 13 Apr 2015

Test Requested : Selected test(s) as requested by client.

Test Method : Please refer to next page(s).

Test Results : Please refer to next page(s).

Conclusion : Based on the performed tests on submitted sample(s), the results of Lead, Mercury, Cadmium, Hexavalent chromium, Polybrominated biphenyls (PBBs), Polybrominated diphenyl ethers (PBDEs) comply with the limits as set by RoHS Directive 2011/65/EU Annex II; recasting 2002/95/EC.

Signed for and on behalf of  
SGS-CSTC Standards Technical Services Co., Ltd. Guangzhou Branch



Alkene Liang  
Approved Signatory



This document is issued by the Company subject to its General Conditions of Service printed overleaf, available on request or accessible at <http://www.sgs.com/en/Terms-and-Conditions.aspx> and, for electronic format documents, subject to Terms and Conditions for Electronic Documents at <http://www.sgs.com/en/Terms-and-Conditions/Terms-e-Documents.aspx>. Attention is drawn to the limitation of liability, indemnification and jurisdiction issues defined therein. Any holder of this document is advised that information contained hereon reflects the Company's findings at the time of its intervention only and within the limits of Client's instructions, if any. The Company's sole responsibility is to its Client and this document does not exonerate parties to a transaction from exercising all their rights and obligations under the transaction documents. This document cannot be reproduced except in full, without prior written approval of the Company. Any unauthorized alteration, forgery or falsification of the content or appearance of this document is unlawful and offenders may be prosecuted to the fullest extent of the law. Unless otherwise stated the results shown in this test report refer only to the sample(s) tested.

Attention: To check the authenticity of testing /inspection report & certificate, please contact us at telephone: (86-755) 8307 1443, or email: [CN.Doccheck@sgs.com](mailto:CN.Doccheck@sgs.com)

198 Kezhu Road, Sciencetech Park Guangzhou Economic & Technology Development District, Guangzhou, China 510663 t (86-20) 82155555 f (86-20) 82075113 www.sgsgroup.com.cn  
中国·广州·经济技术开发区科学城科珠路198号 邮编: 510663 t (86-20) 82155555 f (86-20) 82075113 e [sgs.china@sgs.com](mailto:sgs.china@sgs.com)



# Test Report

No. CANEC1505019605

Date: 13 Apr 2015

Page 2 of 9

Test Results :

Test Part Description :

Specimen No.	SGS Sample ID	Description
SN1	CAN15-050196.002	Transparent tube

Remarks :

- (1) 1 mg/kg = 1 ppm = 0.0001%
- (2) MDL = Method Detection Limit
- (3) ND = Not Detected ( < MDL )
- (4) "-" = Not Regulated

**RoHS Directive 2011/65/EU**

- Test Method :
- (1)With reference to IEC 62321-5:2013, determination of Cadmium by ICP-OES.
  - (2)With reference to IEC 62321-5:2013, determination of Lead by ICP-OES.
  - (3)With reference to IEC 62321-4:2013, determination of Mercury by ICP-OES.
  - (4)With reference to IEC 62321:2008, determination of Hexavalent Chromium by Colorimetric Method using UV-Vis.
  - (5)With reference to IEC 62321:2008, determination of PBBs and PBDEs by GC-MS.

<u>Test Item(s)</u>	<u>Limit</u>	<u>Unit</u>	<u>MDL</u>	<u>002</u>
Cadmium (Cd)	100	mg/kg	2	ND
Lead (Pb)	1,000	mg/kg	2	ND
Mercury (Hg)	1,000	mg/kg	2	ND
Hexavalent Chromium (CrVI)	1,000	mg/kg	2	ND
Sum of PBBs	1,000	mg/kg	-	ND
Monobromobiphenyl	-	mg/kg	5	ND
Dibromobiphenyl	-	mg/kg	5	ND
Tribromobiphenyl	-	mg/kg	5	ND
Tetrabromobiphenyl	-	mg/kg	5	ND
Pentabromobiphenyl	-	mg/kg	5	ND
Hexabromobiphenyl	-	mg/kg	5	ND
Heptabromobiphenyl	-	mg/kg	5	ND
Octabromobiphenyl	-	mg/kg	5	ND
Nonabromobiphenyl	-	mg/kg	5	ND
Decabromobiphenyl	-	mg/kg	5	ND
Sum of PBDEs	1,000	mg/kg	-	ND
Monobromodiphenyl ether	-	mg/kg	5	ND



This document is issued by the Company subject to its General Conditions of Service printed overleaf, available on request or accessible at <http://www.sgs.com/en/Terms-and-Conditions.aspx> and, for electronic format documents, subject to Terms and Conditions for Electronic Documents at <http://www.sgs.com/en/Terms-and-Conditions/Terms-e-Documents.aspx>. Attention is drawn to the limitation of liability, indemnification and jurisdiction issues defined therein. Any holder of this document is advised that information contained hereon reflects the Company's findings at the time of its intervention only and within the limits of Client's instructions, if any. The Company's sole responsibility is to its Client and this document does not exonerate parties to a transaction from exercising all their rights and obligations under the transaction documents. This document cannot be reproduced except in full, without prior written approval of the Company. Any unauthorized alteration, forgery or falsification of the content or appearance of this document is unlawful and offenders may be prosecuted to the fullest extent of the law. Unless otherwise stated the results shown in this test report refer only to the sample(s) tested.

Attention: To check the authenticity of testing /inspection report & certificate, please contact us at telephone: (86-755) 8307 1443, or email: [CN.Doccheck@sgs.com](mailto:CN.Doccheck@sgs.com)

198 Kezhu Road, Sciencetech Park Guangzhou Economic & Technology Development District, Guangzhou, China 510663 t (86-20) 82155555 f (86-20) 82075113 www.sgsgroup.com.cn  
中国·广州·经济技术开发区科学城科珠路198号 邮编: 510663 t (86-20) 82155555 f (86-20) 82075113 e [sgs.china@sgs.com](mailto:sgs.china@sgs.com)

## Test Report

No. CANEC1505019605

Date: 13 Apr 2015

Page 3 of 9

<u>Test Item(s)</u>	<u>Limit</u>	<u>Unit</u>	<u>MDL</u>	<u>002</u>
Dibromodiphenyl ether	-	mg/kg	5	ND
Tribromodiphenyl ether	-	mg/kg	5	ND
Tetrabromodiphenyl ether	-	mg/kg	5	ND
Pentabromodiphenyl ether	-	mg/kg	5	ND
Hexabromodiphenyl ether	-	mg/kg	5	ND
Heptabromodiphenyl ether	-	mg/kg	5	ND
Octabromodiphenyl ether	-	mg/kg	5	ND
Nonabromodiphenyl ether	-	mg/kg	5	ND
Decabromodiphenyl ether	-	mg/kg	5	ND

### Notes :

- (1) The maximum permissible limit is quoted from the directive 2011/65/EU, Annex II.

### Halogen

Test Method : With reference to EN 14582: 2007, analysis was performed by Ion Chromatograph (IC).

<u>Test Item(s)</u>	<u>Unit</u>	<u>MDL</u>	<u>002</u>
Fluorine (F)	mg/kg	50	ND
Chlorine (Cl)	mg/kg	50	ND
Bromine (Br)	mg/kg	50	ND
Iodine (I)	mg/kg	50	ND

### Hexabromocyclododecane (HBCDD)

Test Method : Determination of HBCDD by GC-MS based on IEC 62321:2008.

<u>Test Item(s)</u>	<u>Unit</u>	<u>MDL</u>	<u>002</u>
Hexabromocyclododecane (HBCDD)	mg/kg	10	ND

### Notes :

- (1) Reference Information: Directive 2011/65/EU recasting RoHS directive 2002/95/EC: Hexabromocyclododecane (HBCDD) is considered as a priority for risk evaluation and substance restriction.

### Phthalate

Test Method : Determination of phthalates by GC-MS based on EN 14372:2004.



This document is issued by the Company subject to its General Conditions of Service printed overleaf, available on request or accessible at <http://www.sgs.com/en/Terms-and-Conditions.aspx> and, for electronic format documents, subject to Terms and Conditions for Electronic Documents at <http://www.sgs.com/en/Terms-and-Conditions/Terms-e-Documents.aspx>. Attention is drawn to the limitation of liability, indemnification and jurisdiction issues defined therein. Any holder of this document is advised that information contained hereon reflects the Company's findings at the time of its intervention only and within the limits of Client's instructions, if any. The Company's sole responsibility is to its Client and this document does not exonerate parties to a transaction from exercising all their rights and obligations under the transaction documents. This document cannot be reproduced except in full, without prior written approval of the Company. Any unauthorized alteration, forgery or falsification of the content or appearance of this document is unlawful and offenders may be prosecuted to the fullest extent of the law. Unless otherwise stated the results shown in this test report refer only to the sample(s) tested.

Attention: To check the authenticity of testing / inspection report & certificate, please contact us at telephone: (86-755) 8307 1443, or email: [CN.Doccheck@sgs.com](mailto:CN.Doccheck@sgs.com)

## Test Report

No. CANEC1505019605

Date: 13 Apr 2015

Page 4 of 9

<u>Test Item(s)</u>	<u>CAS NO.</u>	<u>Unit</u>	<u>MDL</u>	<u>002</u>
Dibutyl Phthalate (DBP)	84-74-2	%(w/w)	0.003	ND
Benzylbutyl Phthalate (BBP)	85-68-7	%(w/w)	0.003	ND
Bis(2-ethylhexyl) Phthalate (DEHP)	117-81-7	%(w/w)	0.003	ND

### Notes :

- (1) Reference Information: Directive 2011/65/EU recasting RoHS directive 2002/95/EC:  
Bis (2-ethylhexyl) phthalate (DEHP), Butyl benzyl phthalate (BBP) and Dibutyl phthalate (DBP) are considered as a priority for risk evaluation and substance restriction.



This document is issued by the Company subject to its General Conditions of Service printed overleaf, available on request or accessible at <http://www.sgs.com/en/Terms-and-Conditions.aspx> and, for electronic format documents, subject to Terms and Conditions for Electronic Documents at <http://www.sgs.com/en/Terms-and-Conditions/Terms-e-Documents.aspx>. Attention is drawn to the limitation of liability, indemnification and jurisdiction issues defined therein. Any holder of this document is advised that information contained hereon reflects the Company's findings at the time of its intervention only and within the limits of Client's instructions, if any. The Company's sole responsibility is to its Client and this document does not exonerate parties to a transaction from exercising all their rights and obligations under the transaction documents. This document cannot be reproduced except in full, without prior written approval of the Company. Any unauthorized alteration, forgery or falsification of the content or appearance of this document is unlawful and offenders may be prosecuted to the fullest extent of the law. Unless otherwise stated the results shown in this test report refer only to the sample(s) tested.

Attention: To check the authenticity of testing / inspection report & certificate, please contact us at telephone: (86-755) 8307 1443, or email: [CN.Doccheck@sgs.com](mailto:CN.Doccheck@sgs.com)

SGS-CTI Standards Technical Services Co., Ltd.  
Guangzhou Chemical Laboratory

198 Kezhu Road, Sciencetech Park Guangzhou Economic & Technology Development District, Guangzhou, China 510663 t (86-20) 82155555 f (86-20) 82075113 www.sgsgroup.com.cn  
中国·广州·经济技术开发区科学城科珠路198号 邮编: 510663 t (86-20) 82155555 f (86-20) 82075113 e [sgs.china@sgs.com](mailto:sgs.china@sgs.com)

ATTACHMENTS

RoHS Testing Flow Chart

- 1) Name of the person who made testing: Bruce Xiao / Sunny Hu
- 2) Name of the person in charge of testing: Bella Wang / Cutey Yu
- 3) These samples were dissolved totally by pre-conditioning method according to below flow chart (Cr<sup>6+</sup> and PBBs/PBDEs test method excluded).

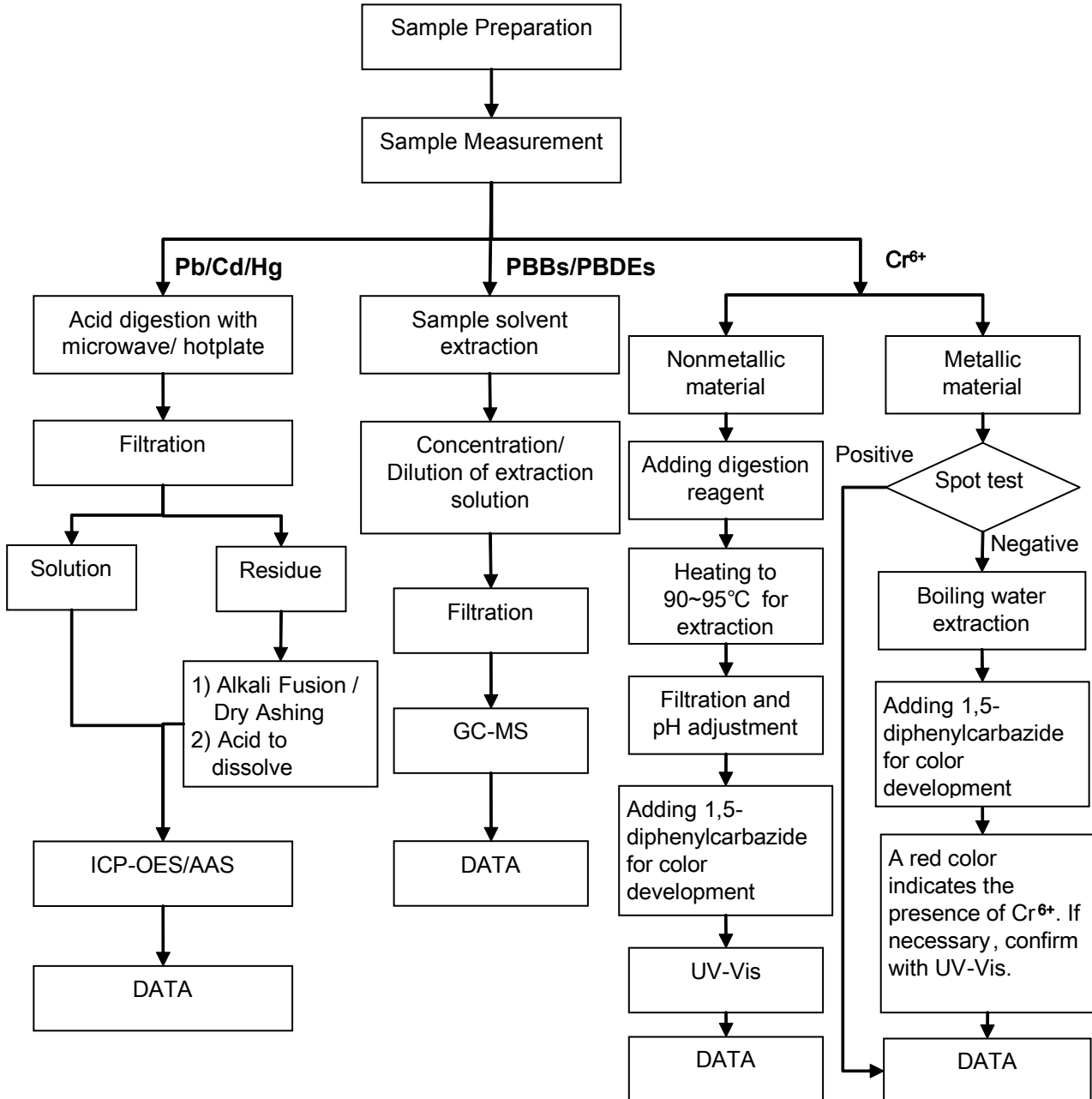

This document is issued by the Company subject to its General Conditions of Service printed overleaf, available on request or accessible at <http://www.sgs.com/en/Terms-and-Conditions.aspx> and, for electronic format documents, subject to Terms and Conditions for Electronic Documents at <http://www.sgs.com/en/Terms-and-Conditions/Terms-e-Documents.aspx>. Attention is drawn to the limitation of liability, indemnification and jurisdiction issues defined therein. Any holder of this document is advised that information contained herein reflects the Company's findings at the time of its intervention only and within the limits of Client's instructions, if any. The Company's sole responsibility is to its Client and this document does not exonerate parties to a transaction from exercising all their rights and obligations under the transaction documents. This document cannot be reproduced except in full, without prior written approval of the Company. Any unauthorized alteration, forgery or falsification of the content or appearance of this document is unlawful and offenders may be prosecuted to the fullest extent of the law. Unless otherwise stated the results shown in this test report refer only to the sample(s) tested.

Attention: To check the authenticity of testing / inspection report & certificate, please contact us at telephone: (86-755) 8307 1443, or email: CN.Doccheck@sgs.com

198 Kezhu Road, Sciencetech Park Guangzhou Economic & Technology Development District, Guangzhou, China 510663 t (86-20) 82155555 f (86-20) 82075113 www.sgsgroup.com.cn  
中国·广州·经济技术开发区科学城科珠路198号 邮编: 510663 t (86-20) 82155555 f (86-20) 82075113 e sgs.china@sgs.com

ATTACHMENTS

Phthalates Testing Flow Chart

- 1) Name of the person who made testing: Sunny Hu
- 2) Name of the person in charge of testing: Cutey Yu

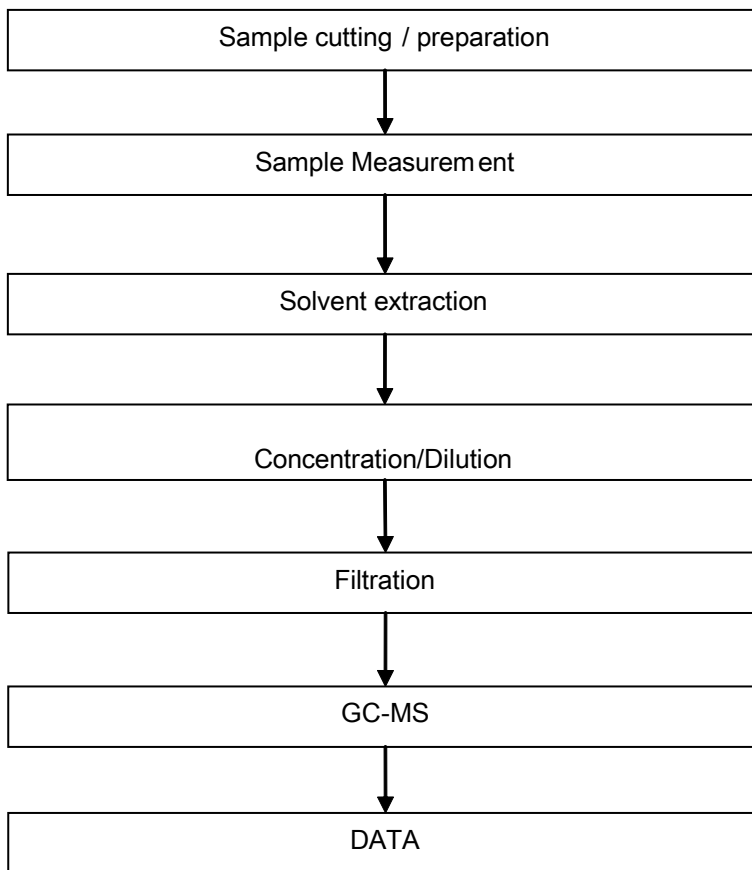

This document is issued by the Company subject to its General Conditions of Service printed overleaf, available on request or accessible at <http://www.sgs.com/en/Terms-and-Conditions.aspx> and, for electronic format documents, subject to Terms and Conditions for Electronic Documents at <http://www.sgs.com/en/Terms-and-Conditions/Terms-e-Documents.aspx>. Attention is drawn to the limitation of liability, indemnification and jurisdiction issues defined therein. Any holder of this document is advised that information contained hereon reflects the Company's findings at the time of its intervention only and within the limits of Client's instructions, if any. The Company's sole responsibility is to its Client and this document does not exonerate parties to a transaction from exercising all their rights and obligations under the transaction documents. This document cannot be reproduced except in full, without prior written approval of the Company. Any unauthorized alteration, forgery or falsification of the content or appearance of this document is unlawful and offenders may be prosecuted to the fullest extent of the law. Unless otherwise stated the results shown in this test report refer only to the sample(s) tested.

Attention: To check the authenticity of testing / inspection report & certificate, please contact us at telephone: (86-755) 8307 1443, or email: [CN.Doccheck@sgs.com](mailto:CN.Doccheck@sgs.com)

198 Kezhu Road, Sciencetech Park Guangzhou Economic & Technology Development District, Guangzhou, China 510663 t (86-20) 82155555 f (86-20) 82075113 www.sgsgroup.com.cn  
 中国·广州·经济技术开发区科学城科珠路198号 邮编: 510663 t (86-20) 82155555 f (86-20) 82075113 e [sgs.china@sgs.com](mailto:sgs.china@sgs.com)



ATTACHMENTS

Halogen Testing Flow Chart

- 1) Name of the person who made testing: Hanming Xiao
- 2) Name of the person in charge of testing: Bella Wang

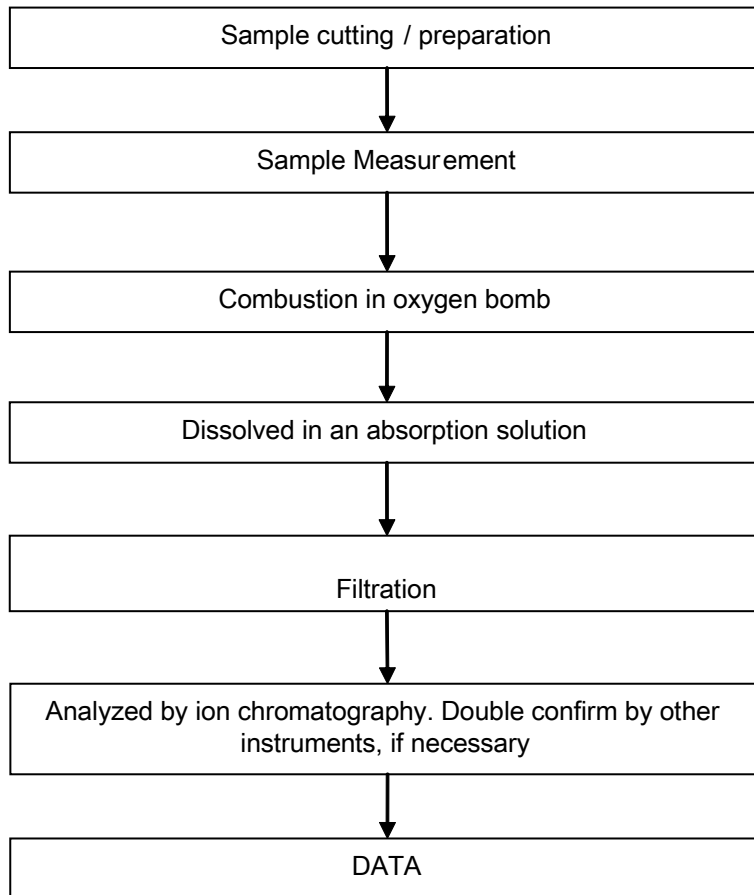

This document is issued by the Company subject to its General Conditions of Service printed overleaf, available on request or accessible at <http://www.sgs.com/en/Terms-and-Conditions.aspx> and, for electronic format documents, subject to Terms and Conditions for Electronic Documents at <http://www.sgs.com/en/Terms-and-Conditions/Terms-e-Documents.aspx>. Attention is drawn to the limitation of liability, indemnification and jurisdiction issues defined therein. Any holder of this document is advised that information contained hereon reflects the Company's findings at the time of its intervention only and within the limits of Client's instructions, if any. The Company's sole responsibility is to its Client and this document does not exonerate parties to a transaction from exercising all their rights and obligations under the transaction documents. This document cannot be reproduced except in full, without prior written approval of the Company. Any unauthorized alteration, forgery or falsification of the content or appearance of this document is unlawful and offenders may be prosecuted to the fullest extent of the law. Unless otherwise stated the results shown in this test report refer only to the sample(s) tested.

Attention: To check the authenticity of testing / inspection report & certificate, please contact us at telephone: (86-755) 8307 1443, or email: [CN.Doccheck@sgs.com](mailto:CN.Doccheck@sgs.com)

198 Kezhu Road, Sciencetech Park Guangzhou Economic & Technology Development District, Guangzhou, China 510663 t (86-20) 82155555 f (86-20) 82075113 www.sgsgroup.com.cn  
 中国·广州·经济技术开发区科学城科珠路198号 邮编: 510663 t (86-20) 82155555 f (86-20) 82075113 e [sgs.china@sgs.com](mailto:sgs.china@sgs.com)



ATTACHMENTS

HBCDD Testing Flow Chart

- 1) Name of the person who made testing: Sunny Hu
- 2) Name of the person in charge of testing: Cutey Yu

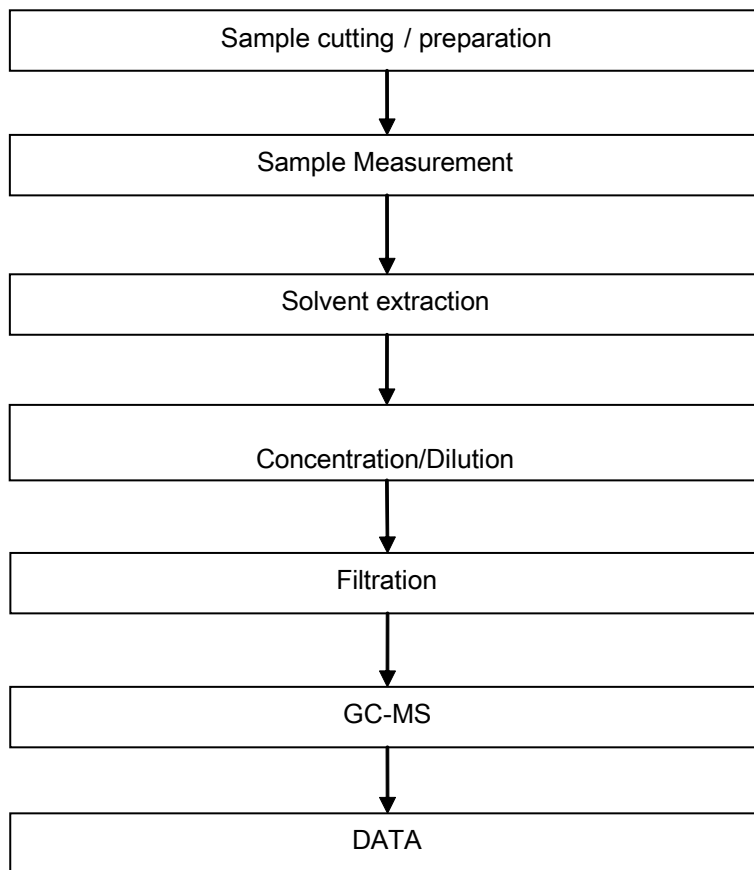

This document is issued by the Company subject to its General Conditions of Service printed overleaf, available on request or accessible at <http://www.sgs.com/en/Terms-and-Conditions.aspx> and, for electronic format documents, subject to Terms and Conditions for Electronic Documents at <http://www.sgs.com/en/Terms-and-Conditions/Terms-e-Documents.aspx>. Attention is drawn to the limitation of liability, indemnification and jurisdiction issues defined therein. Any holder of this document is advised that information contained hereon reflects the Company's findings at the time of its intervention only and within the limits of Client's instructions, if any. The Company's sole responsibility is to its Client and this document does not exonerate parties to a transaction from exercising all their rights and obligations under the transaction documents. This document cannot be reproduced except in full, without prior written approval of the Company. Any unauthorized alteration, forgery or falsification of the content or appearance of this document is unlawful and offenders may be prosecuted to the fullest extent of the law. Unless otherwise stated the results shown in this test report refer only to the sample(s) tested.

Attention: To check the authenticity of testing / inspection report & certificate, please contact us at telephone: (86-755) 8307 1443, or email: [CN.Doccheck@sgs.com](mailto:CN.Doccheck@sgs.com)

198 Kezhu Road, Sciencetech Park Guangzhou Economic & Technology Development District, Guangzhou, China 510663 t (86-20) 82155555 f (86-20) 82075113 www.sgsgroup.com.cn  
 中国·广州·经济技术开发区科学城科珠路198号 邮编: 510663 t (86-20) 82155555 f (86-20) 82075113 e [sgs.china@sgs.com](mailto:sgs.china@sgs.com)

Sample photo:



SGS authenticate the photo on original report only

\*\*\* End of Report \*\*\*

## Test Report

No. CANEC1500269601

Date: 13 Jan 2015

Page 1 of 10

SHENZHEN WOER HEAT-SHRINKABLE MATERIAL CO.,LTD.

WOER MANSION,LANJING NORTH ROAD,PINGSHAN INDUSTRIAL ZONE, LONGGANG DISTRICT,SHENZHEN CHINA

The following sample(s) was/were submitted and identified on behalf of the clients as : Please see remark

SGS Job No. : CP15-000748 - SZ

Date of Sample Received : 07 Jan 2015

Testing Period : 07 Jan 2015 - 13 Jan 2015

Test Requested : Selected test(s) as requested by client.

Test Method : Please refer to next page(s).

Test Results : Please refer to next page(s).

Conclusion : Based on the performed tests on submitted sample(s), the results of Lead, Mercury, Cadmium, Hexavalent chromium, Polybrominated biphenyls (PBBs), Polybrominated diphenyl ethers (PBDEs) comply with the limits as set by RoHS Directive 2011/65/EU Annex II; recasting 2002/95/EC.

Signed for and on behalf of  
SGS-CSTC Ltd.



Merry Lv  
Approved Signatory



This document is issued by the Company subject to its General Conditions of Service printed overleaf, available on request or accessible at <http://www.sgs.com/en/Terms-and-Conditions.aspx> and, for electronic format documents, subject to Terms and Conditions for Electronic Documents at <http://www.sgs.com/en/Terms-and-Conditions/Terms-e-Documents.aspx>. Attention is drawn to the limitation of liability, indemnification and jurisdiction issues defined therein. Any holder of this document is advised that information contained hereon reflects the Company's findings at the time of its intervention only and within the limits of Client's instructions, if any. The Company's sole responsibility is to its Client and this document does not exonerate parties to a transaction from exercising all their rights and obligations under the transaction documents. This document cannot be reproduced except in full, without prior written approval of the Company. Any unauthorized alteration, forgery or falsification of the content or appearance of this document is unlawful and offenders may be prosecuted to the fullest extent of the law. Unless otherwise stated the results shown in this test report refer only to the sample(s) tested.

Attention: To check the authenticity of testing /inspection report & certificate, please contact us at telephone: (86-755) 8307 1443, or email: [CN.Doccheck@sgs.com](mailto:CN.Doccheck@sgs.com)

198 Kezhu Road, Sciencetech Park Guangzhou Economic & Technology Development District, Guangzhou, China 510663 t (86-20) 82155555 f (86-20) 82075113 www.sgsgroup.com.cn  
中国·广州·经济技术开发区科学城科珠路198号 邮编: 510663 t (86-20) 82155555 f (86-20) 82075113 e [sgs.china@sgs.com](mailto:sgs.china@sgs.com)

# Test Report

No. CANEC1500269601

Date: 13 Jan 2015

Page 2 of 10

Test Results :

Test Part Description :

Specimen No.	SGS Sample ID	Description
SN1	CAN15-002696.001	Black plastic tube w/ white printing

Remarks :

- (1) 1 mg/kg = 1 ppm = 0.0001%
- (2) MDL = Method Detection Limit
- (3) ND = Not Detected ( < MDL )
- (4) "-" = Not Regulated

**RoHS Directive 2011/65/EU**

- Test Method :
- (1)With reference to IEC 62321-5:2013, determination of Cadmium by ICP-OES.
  - (2)With reference to IEC 62321-5:2013, determination of Lead by ICP-OES.
  - (3)With reference to IEC 62321-4:2013, determination of Mercury by ICP-OES.
  - (4)With reference to IEC 62321:2008, determination of Hexavalent Chromium by Colorimetric Method using UV-Vis.
  - (5)With reference to IEC 62321:2008, determination of PBBs and PBDEs by GC-MS.

<u>Test Item(s)</u>	<u>Limit</u>	<u>Unit</u>	<u>MDL</u>	<u>001</u>
Cadmium (Cd)	100	mg/kg	2	ND
Lead (Pb)	1,000	mg/kg	2	ND
Mercury (Hg)	1,000	mg/kg	2	ND
Hexavalent Chromium (CrVI)	1,000	mg/kg	2	ND
Sum of PBBs	1,000	mg/kg	-	ND
Monobromobiphenyl	-	mg/kg	5	ND
Dibromobiphenyl	-	mg/kg	5	ND
Tribromobiphenyl	-	mg/kg	5	ND
Tetrabromobiphenyl	-	mg/kg	5	ND
Pentabromobiphenyl	-	mg/kg	5	ND
Hexabromobiphenyl	-	mg/kg	5	ND
Heptabromobiphenyl	-	mg/kg	5	ND
Octabromobiphenyl	-	mg/kg	5	ND
Nonabromobiphenyl	-	mg/kg	5	ND
Decabromobiphenyl	-	mg/kg	5	ND
Sum of PBDEs	1,000	mg/kg	-	ND
Monobromodiphenyl ether	-	mg/kg	5	ND



This document is issued by the Company subject to its General Conditions of Service printed overleaf, available on request or accessible at <http://www.sgs.com/en/Terms-and-Conditions.aspx> and, for electronic format documents, subject to Terms and Conditions for Electronic Documents at <http://www.sgs.com/en/Terms-and-Conditions/Terms-e-Documents.aspx>. Attention is drawn to the limitation of liability, indemnification and jurisdiction issues defined therein. Any holder of this document is advised that information contained hereon reflects the Company's findings at the time of its intervention only and within the limits of Client's instructions, if any. The Company's sole responsibility is to its Client and this document does not exonerate parties to a transaction from exercising all their rights and obligations under the transaction documents. This document cannot be reproduced except in full, without prior written approval of the Company. Any unauthorized alteration, forgery or falsification of the content or appearance of this document is unlawful and offenders may be prosecuted to the fullest extent of the law. Unless otherwise stated the results shown in this test report refer only to the sample(s) tested.

Attention: To check the authenticity of testing /inspection report & certificate, please contact us at telephone: (86-755) 8307 1443, or email: [CN.Doccheck@sgs.com](mailto:CN.Doccheck@sgs.com)

198 Kezhu Road, Sciencetech Park Guangzhou Economic & Technology Development District, Guangzhou, China 510663 t (86-20) 82155555 f (86-20) 82075113 www.sgsgroup.com.cn  
中国·广州·经济技术开发区科学城科珠路198号 邮编: 510663 t (86-20) 82155555 f (86-20) 82075113 e [sgs.china@sgs.com](mailto:sgs.china@sgs.com)



## Test Report

No. CANEC1500269601

Date: 13 Jan 2015

Page 3 of 10

<u>Test Item(s)</u>	<u>Limit</u>	<u>Unit</u>	<u>MDL</u>	<u>001</u>
Dibromodiphenyl ether	-	mg/kg	5	ND
Tribromodiphenyl ether	-	mg/kg	5	ND
Tetrabromodiphenyl ether	-	mg/kg	5	ND
Pentabromodiphenyl ether	-	mg/kg	5	ND
Hexabromodiphenyl ether	-	mg/kg	5	ND
Heptabromodiphenyl ether	-	mg/kg	5	ND
Octabromodiphenyl ether	-	mg/kg	5	ND
Nonabromodiphenyl ether	-	mg/kg	5	ND
Decabromodiphenyl ether	-	mg/kg	5	ND

### Notes :

- (1) The maximum permissible limit is quoted from the directive 2011/65/EU, Annex II.

### Halogen

Test Method : With reference to EN 14582: 2007, analysis was performed by Ion Chromatograph (IC).

<u>Test Item(s)</u>	<u>Unit</u>	<u>MDL</u>	<u>001</u>
Fluorine (F)	mg/kg	50	95
Chlorine (Cl)	mg/kg	50	ND
Bromine (Br)	mg/kg	50	ND
Iodine (I)	mg/kg	50	ND

### Hexabromocyclododecane (HBCDD)

Test Method : Determination of HBCDD by GC-MS based on IEC 62321:2008.

<u>Test Item(s)</u>	<u>Unit</u>	<u>MDL</u>	<u>001</u>
Hexabromocyclododecane (HBCDD)	mg/kg	10	ND

### Notes :

- (1) Reference Information: Directive 2011/65/EU recasting RoHS directive 2002/95/EC: Hexabromocyclododecane (HBCDD) is considered as a priority for risk evaluation and substance restriction.

### Phthalate

Test Method : Determination of phthalates by GC-MS based on EN 14372:2004.



This document is issued by the Company subject to its General Conditions of Service printed overleaf, available on request or accessible at <http://www.sgs.com/en/Terms-and-Conditions.aspx> and, for electronic format documents, subject to Terms and Conditions for Electronic Documents at <http://www.sgs.com/en/Terms-and-Conditions/Terms-e-Documents.aspx>. Attention is drawn to the limitation of liability, indemnification and jurisdiction issues defined therein. Any holder of this document is advised that information contained hereon reflects the Company's findings at the time of its intervention only and within the limits of Client's instructions, if any. The Company's sole responsibility is to its Client and this document does not exonerate parties to a transaction from exercising all their rights and obligations under the transaction documents. This document cannot be reproduced except in full, without prior written approval of the Company. Any unauthorized alteration, forgery or falsification of the content or appearance of this document is unlawful and offenders may be prosecuted to the fullest extent of the law. Unless otherwise stated the results shown in this test report refer only to the sample(s) tested.

Attention: To check the authenticity of testing / inspection report & certificate, please contact us at telephone: (86-755) 8307 1443, or email: [CN.Doccheck@sgs.com](mailto:CN.Doccheck@sgs.com)

## Test Report

No. CANEC1500269601

Date: 13 Jan 2015

Page 4 of 10

<u>Test Item(s)</u>	<u>CAS NO.</u>	<u>Unit</u>	<u>MDL</u>	<u>001</u>
Dibutyl Phthalate (DBP)	84-74-2	%(w/w)	0.003	ND
Benzylbutyl Phthalate (BBP)	85-68-7	%(w/w)	0.003	ND
Bis(2-ethylhexyl) Phthalate (DEHP)	117-81-7	%(w/w)	0.003	ND

### Notes :

- (1) Reference Information: Directive 2011/65/EU recasting RoHS directive 2002/95/EC:  
Bis (2-ethylhexyl) phthalate (DEHP), Butyl benzyl phthalate (BBP) and Dibutyl phthalate (DBP) are considered as a priority for risk evaluation and substance restriction.





This document is issued by the Company subject to its General Conditions of Service printed overleaf, available on request or accessible at <http://www.sgs.com/en/Terms-and-Conditions.aspx> and, for electronic format documents, subject to Terms and Conditions for Electronic Documents at <http://www.sgs.com/en/Terms-and-Conditions/Terms-e-Documents.aspx>. Attention is drawn to the limitation of liability, indemnification and jurisdiction issues defined therein. Any holder of this document is advised that information contained hereon reflects the Company's findings at the time of its intervention only and within the limits of Client's instructions, if any. The Company's sole responsibility is to its Client and this document does not exonerate parties to a transaction from exercising all their rights and obligations under the transaction documents. This document cannot be reproduced except in full, without prior written approval of the Company. Any unauthorized alteration, forgery or falsification of the content or appearance of this document is unlawful and offenders may be prosecuted to the fullest extent of the law. Unless otherwise stated the results shown in this test report refer only to the sample(s) tested.

Attention: To check the authenticity of testing /inspection report & certificate, please contact us at telephone: (86-755) 8307 1443, or email: [CN.Doccheck@sgs.com](mailto:CN.Doccheck@sgs.com)

198 Kezhu Road, Sciencetech Park Guangzhou Economic & Technology Development District, Guangzhou, China 510663 t (86-20) 82155555 f (86-20) 82075113 www.sgsgroup.com.cn  
中国·广州·经济技术开发区科学城科珠路198号 邮编: 510663 t (86-20) 82155555 f (86-20) 82075113 e [sgs.china@sgs.com](mailto:sgs.china@sgs.com)



Sample Name:

RSFR-H HEAT SHRINKABLE TUBINGS ( E203950   WOER RSFR-H  
TUBE 125°C VW-1 H )



This document is issued by the Company subject to its General Conditions of Service printed overleaf, available on request or accessible at <http://www.sgs.com/en/Terms-and-Conditions.aspx> and, for electronic format documents, subject to Terms and Conditions for Electronic Documents at <http://www.sgs.com/en/Terms-and-Conditions/Terms-e-Documents.aspx>. Attention is drawn to the limitation of liability, indemnification and jurisdiction issues defined therein. Any holder of this document is advised that information contained hereon reflects the Company's findings at the time of its intervention only and within the limits of Client's instructions, if any. The Company's sole responsibility is to its Client and this document does not exonerate parties to a transaction from exercising all their rights and obligations under the transaction documents. This document cannot be reproduced except in full, without prior written approval of the Company. Any unauthorized alteration, forgery or falsification of the content or appearance of this document is unlawful and offenders may be prosecuted to the fullest extent of the law. Unless otherwise stated the results shown in this test report refer only to the sample(s) tested.  
**Attention: To check the authenticity of testing /inspection report & certificate, please contact us at telephone: (86-755) 8307 1443, or email: CN.Doccheck@sgs.com**

198 Kezhu Road, Sciencetech Park Guangzhou Economic & Technology Development District, Guangzhou, China 510663 t (86-20) 82155555 f (86-20) 82075113 www.sgsgroup.com.cn  
中国·广州·经济技术开发区科学城科珠路198号 邮编: 510663 t (86-20) 82155555 f (86-20) 82075113 e sgs.china@sgs.com

ATTACHMENTS

RoHS Testing Flow Chart

- 1) Name of the person who made testing: Bruce Xiao / Sunny Hu
- 2) Name of the person in charge of testing: Bella Wang / Cutey Yu
- 3) These samples were dissolved totally by pre-conditioning method according to below flow chart (Cr<sup>6+</sup> and PBBs/PBDEs test method excluded).

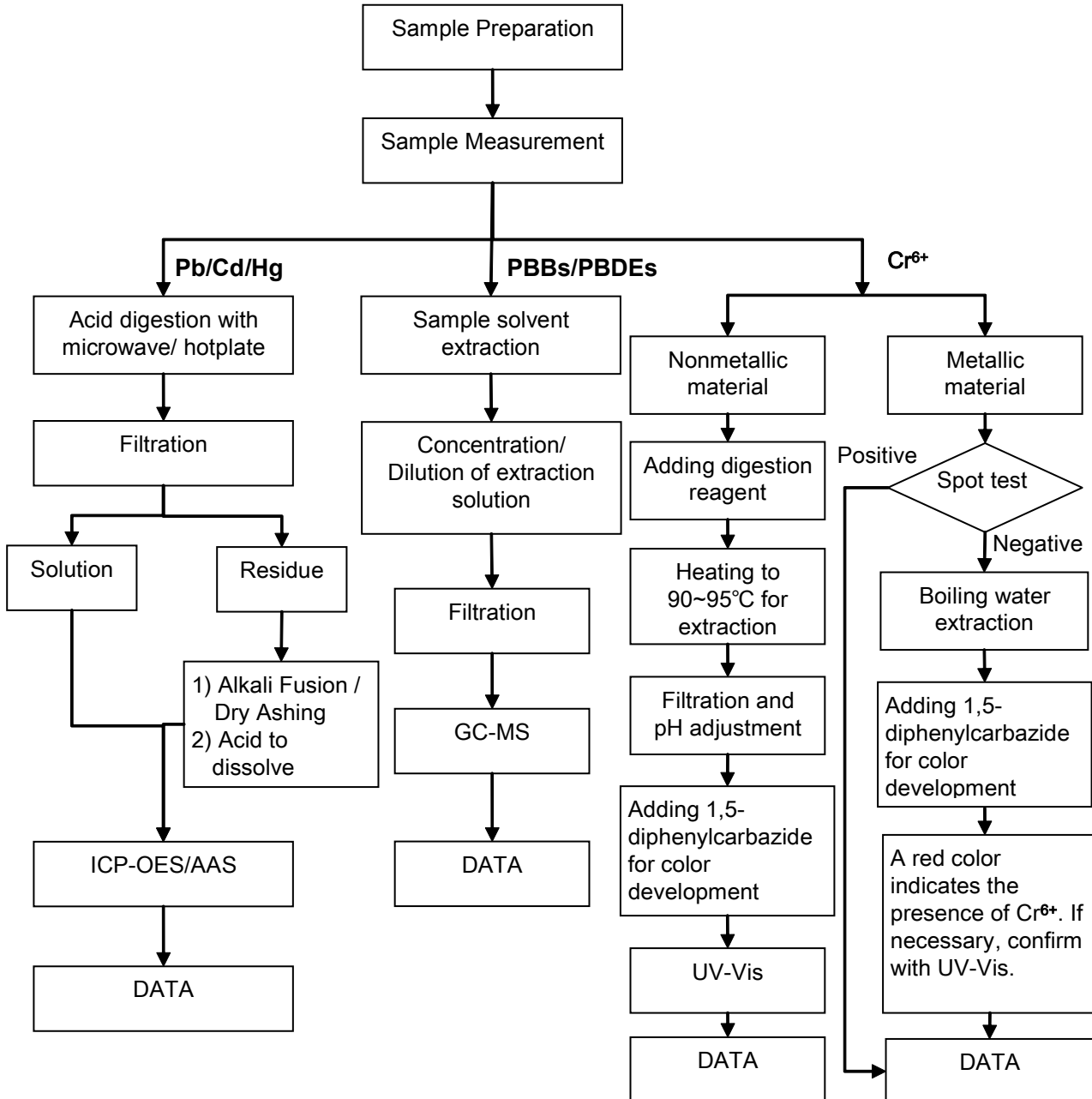

This document is issued by the Company subject to its General Conditions of Service printed overleaf, available on request or accessible at <http://www.sgs.com/en/Terms-and-Conditions.aspx> and, for electronic format documents, subject to Terms and Conditions for Electronic Documents at <http://www.sgs.com/en/Terms-and-Conditions/Terms-e-Documents.aspx>. Attention is drawn to the limitation of liability, indemnification and jurisdiction issues defined therein. Any holder of this document is advised that information contained hereon reflects the Company's findings at the time of its intervention only and within the limits of Client's instructions, if any. The Company's sole responsibility is to its Client and this document does not exonerate parties to a transaction from exercising all their rights and obligations under the transaction documents. This document cannot be reproduced except in full, without prior written approval of the Company. Any unauthorized alteration, forgery or falsification of the content or appearance of this document is unlawful and offenders may be prosecuted to the fullest extent of the law. Unless otherwise stated the results shown in this test report refer only to the sample(s) tested.

Attention: To check the authenticity of testing /inspection report & certificate, please contact us at telephone: (86-755) 8307 1443, or email: CN.Doccheck@sgs.com

198 Kezhu Road, Sciencetech Park Guangzhou Economic & Technology Development District, Guangzhou, China 510663 t (86-20) 82155555 f (86-20) 82075113 www.sgs.com.cn  
 中国·广州·经济技术开发区科学城科珠路198号 邮编: 510663 t (86-20) 82155555 f (86-20) 82075113 e sgs.china@sgs.com

ATTACHMENTS

HBCDD Testing Flow Chart

- 1) Name of the person who made testing: Sunny Hu
- 2) Name of the person in charge of testing: Cutey Yu

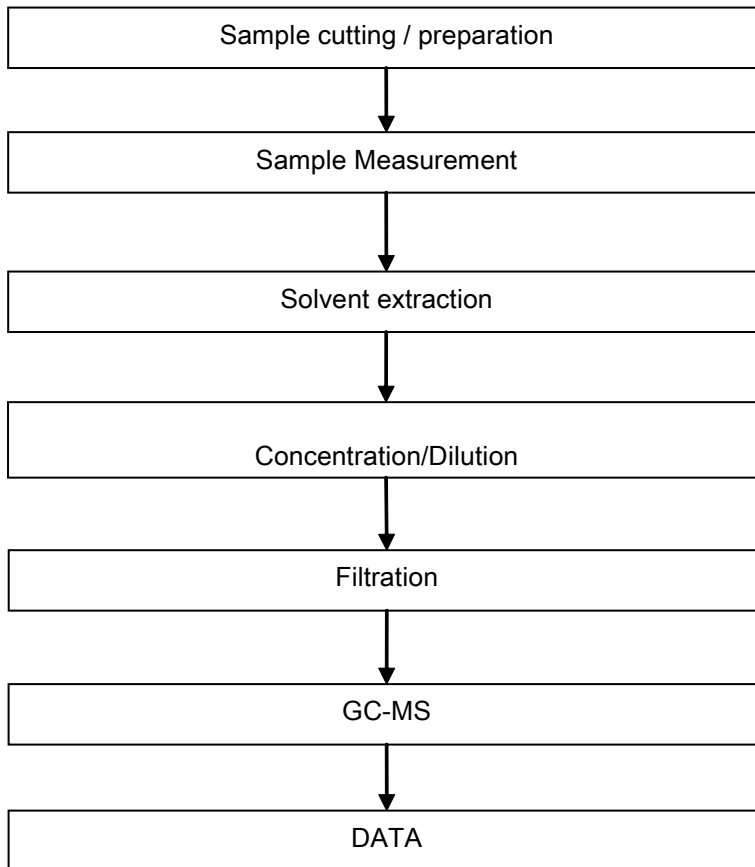

This document is issued by the Company subject to its General Conditions of Service printed overleaf, available on request or accessible at <http://www.sgs.com/en/Terms-and-Conditions.aspx> and, for electronic format documents, subject to Terms and Conditions for Electronic Documents at <http://www.sgs.com/en/Terms-and-Conditions/Terms-e-Documents.aspx>. Attention is drawn to the limitation of liability, indemnification and jurisdiction issues defined therein. Any holder of this document is advised that information contained hereon reflects the Company's findings at the time of its intervention only and within the limits of Client's instructions, if any. The Company's sole responsibility is to its Client and this document does not exonerate parties to a transaction from exercising all their rights and obligations under the transaction documents. This document cannot be reproduced except in full, without prior written approval of the Company. Any unauthorized alteration, forgery or falsification of the content or appearance of this document is unlawful and offenders may be prosecuted to the fullest extent of the law. Unless otherwise stated the results shown in this test report refer only to the sample(s) tested.  
**Attention: To check the authenticity of testing / inspection report & certificate, please contact us at telephone: (86-755) 8307 1443, or email: CN.Doccheck@sgs.com**

198 Kezhu Road, Sciencetech Park Guangzhou Economic & Technology Development District, Guangzhou, China 510663 t (86-20) 82155555 f (86-20) 82075113 www.sgsgroup.com.cn  
中国·广州·经济技术开发区科学城科珠路198号 邮编: 510663 t (86-20) 82155555 f (86-20) 82075113 e sgs.china@sgs.com

ATTACHMENTS

Phthalates Testing Flow Chart

- 1) Name of the person who made testing: Sunny Hu
- 2) Name of the person in charge of testing: Cutey Yu

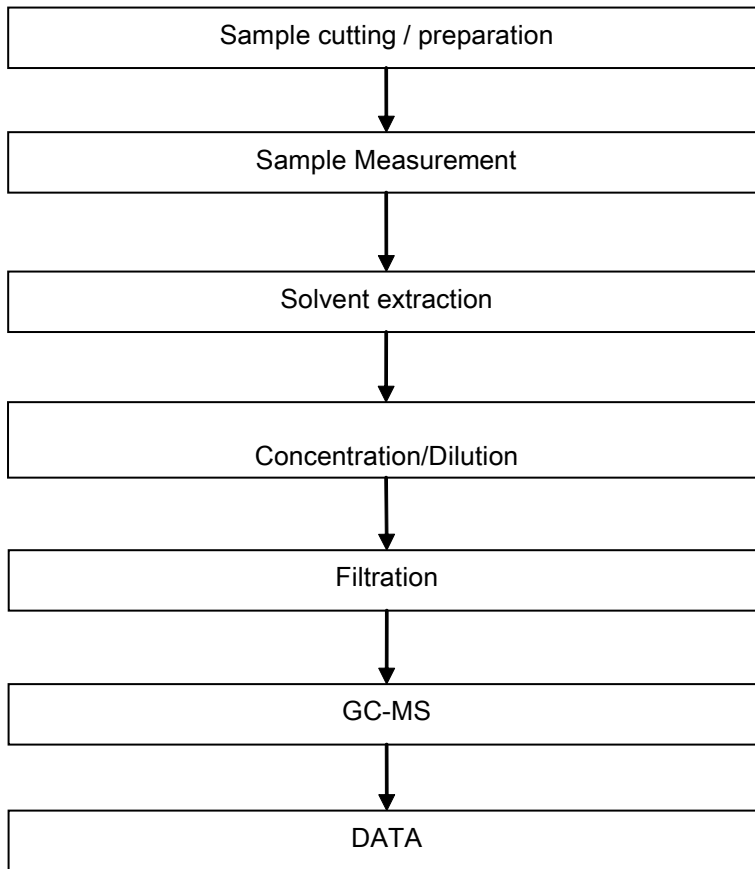

This document is issued by the Company subject to its General Conditions of Service printed overleaf, available on request or accessible at <http://www.sgs.com/en/Terms-and-Conditions.aspx> and, for electronic format documents, subject to Terms and Conditions for Electronic Documents at <http://www.sgs.com/en/Terms-and-Conditions/Terms-e-Documents.aspx>. Attention is drawn to the limitation of liability, indemnification and jurisdiction issues defined therein. Any holder of this document is advised that information contained hereon reflects the Company's findings at the time of its intervention only and within the limits of Client's instructions, if any. The Company's sole responsibility is to its Client and this document does not exonerate parties to a transaction from exercising all their rights and obligations under the transaction documents. This document cannot be reproduced except in full, without prior written approval of the Company. Any unauthorized alteration, forgery or falsification of the content or appearance of this document is unlawful and offenders may be prosecuted to the fullest extent of the law. Unless otherwise stated the results shown in this test report refer only to the sample(s) tested.  
 Attention: To check the authenticity of testing / inspection report & certificate, please contact us at telephone: (86-755) 8307 1443, or email: CN.Doccheck@sgs.com

198 Kezhu Road, Sciencetech Park Guangzhou Economic & Technology Development District, Guangzhou, China 510663 t (86-20) 82155555 f (86-20) 82075113 www.sgsgroup.com.cn  
 中国·广州·经济技术开发区科学城科珠路198号 邮编: 510663 t (86-20) 82155555 f (86-20) 82075113 e sgs.china@sgs.com

ATTACHMENTS

Halogen Testing Flow Chart

- 1) Name of the person who made testing: Hanming Xiao
- 2) Name of the person in charge of testing: Bella Wang

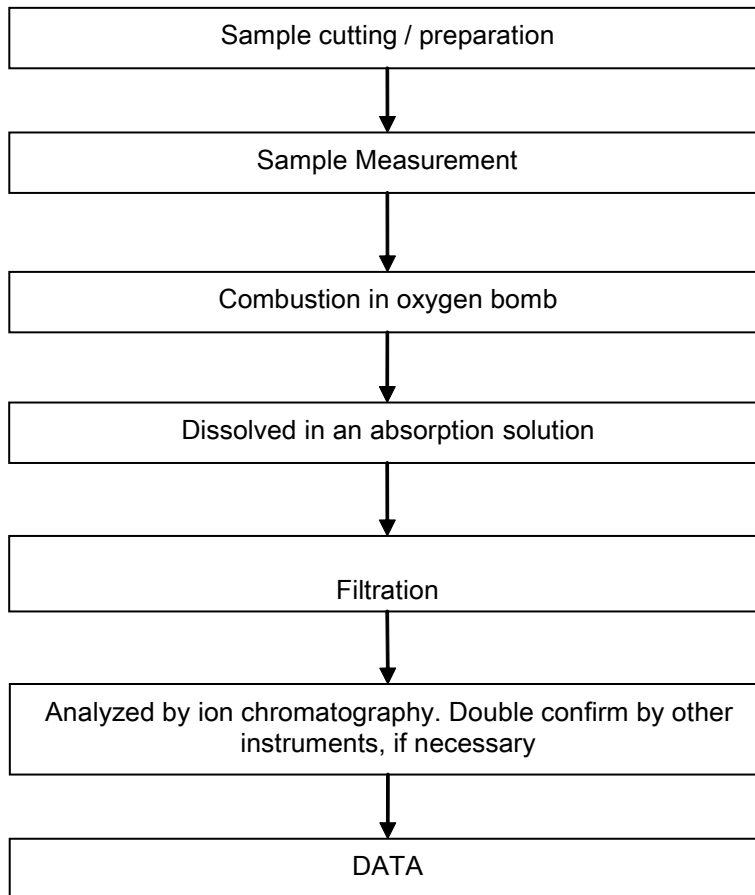

This document is issued by the Company subject to its General Conditions of Service printed overleaf, available on request or accessible at <http://www.sgs.com/en/Terms-and-Conditions.aspx> and, for electronic format documents, subject to Terms and Conditions for Electronic Documents at <http://www.sgs.com/en/Terms-and-Conditions/Terms-e-Documents.aspx>. Attention is drawn to the limitation of liability, indemnification and jurisdiction issues defined therein. Any holder of this document is advised that information contained hereon reflects the Company's findings at the time of its intervention only and within the limits of Client's instructions, if any. The Company's sole responsibility is to its Client and this document does not exonerate parties to a transaction from exercising all their rights and obligations under the transaction documents. This document cannot be reproduced except in full, without prior written approval of the Company. Any unauthorized alteration, forgery or falsification of the content or appearance of this document is unlawful and offenders may be prosecuted to the fullest extent of the law. Unless otherwise stated the results shown in this test report refer only to the sample(s) tested.

Attention: To check the authenticity of testing / inspection report & certificate, please contact us at telephone: (86-755) 8307 1443, or email: [CN.Doccheck@sgs.com](mailto:CN.Doccheck@sgs.com)

199 Kezhu Road, Sciotech Park Guangzhou Economic & Technology Development District, Guangzhou, China 510663 t (86-20) 82155555 f (86-20) 82075113 www.sgsgroup.com.cn  
 中国·广州·经济技术开发区科学城科珠路198号 邮编: 510663 t (86-20) 82155555 f (86-20) 82075113 e [sgs.china@sgs.com](mailto:sgs.china@sgs.com)



Sample photo:



SGS authenticate the photo on original report only

\*\*\* End of Report \*\*\*



## 编织网管参数明细

产品型号	产品编码	规格(MM)	材质	扩充范围(单根丝)		温度范围	
				最小	最大		
JXL-001	321025	3MM	PET	3MM	13MM	-103°F-257°F	-75°C-125°C
JXL-002	401020	3MM	PET	3MM	14MM	-103°F-257°F	-75°C-125°C
JXL-003	401025	4MM	PET	4MM	14MM	-103°F-257°F	-75°C-125°C
JXL-004	481025	5MM	PET	5MM	20MM	-103°F-257°F	-75°C-125°C
JXL-005	561020	5MM	PET	5MM	18MM	-103°F-257°F	-75°C-125°C
JXL-006	561025	6MM	PET	6MM	23MM	-103°F-257°F	-75°C-125°C
JXL-007	641025	7MM	PET	7MM	26MM	-103°F-257°F	-75°C-125°C
JXL-008	721025	8MM	PET	8MM	29MM	-103°F-257°F	-75°C-125°C
JXL-009	961025	12MM	PET	12MM	36MM	-103°F-257°F	-75°C-125°C
JXL-010	1201025	14MM	PET	14MM	45MM	-103°F-257°F	-75°C-125°C
JXL-011	243020	4MM	PET	4MM	12MM	-103°F-257°F	-75°C-125°C
JXL-012	243025	6MM	PET	6MM	12MM	-103°F-257°F	-75°C-125°C
JXL-013	322025	6MM	PET	6MM	15MM	-103°F-257°F	-75°C-125°C
JXL-014	323020	6MM	PET	6MM	16MM	-103°F-257°F	-75°C-125°C
JXL-015	323025	8MM	PET	8MM	19MM	-103°F-257°F	-75°C-125°C
JXL-016	403020	8MM	PET	8MM	21MM	-103°F-257°F	-75°C-125°C
JXL-017	403025	10MM	PET	10MM	23MM	-103°F-257°F	-75°C-125°C
JXL-018	482020	8MM	PET	8MM	20MM	-103°F-257°F	-75°C-125°C
JXL-019	483020	10MM	PET	10MM	25MM	-103°F-257°F	-75°C-125°C
JXL-020	483025	14MM	PET	14MM	26MM	-103°F-257°F	-75°C-125°C
JXL-021	563020	12MM	PET	12MM	31MM	-103°F-257°F	-75°C-125°C
JXL-022	563025	16MM	PET	16MM	32MM	-103°F-257°F	-75°C-125°C
JXL-023	643020	16MM	PET	16MM	33MM	-103°F-257°F	-75°C-125°C
JXL-024	643025	18MM	PET	18MM	36MM	-103°F-257°F	-75°C-125°C
JXL-025	723020	18MM	PET	18MM	38MM	-103°F-257°F	-75°C-125°C
JXL-026	723025	25MM	PET	25MM	42MM	-103°F-257°F	-75°C-125°C
JXL-027	963020	25MM	PET	25MM	56MM	-103°F-257°F	-75°C-125°C
JXL-028	963025	35MM	PET	35MM	61MM	-103°F-257°F	-75°C-125°C
JXL-029	964025	40MM	PET	40MM	65MM	-103°F-257°F	-75°C-125°C
JXL-030	1203020	30MM	PET	30MM	70MM	-103°F-257°F	-75°C-125°C
JXL-031	1203025	35MM	PET	35MM	82MM	-103°F-257°F	-75°C-125°C
JXL-032	1204025	42MM	PET	42MM	83MM	-103°F-257°F	-75°C-125°C
JXL-033	1206025	65MM	PET	65MM	90MM	-103°F-257°F	-75°C-125°C
JXL-034	1054025	64MM	PET	64MM	84MM	-103°F-257°F	-75°C-125°C

TEL  
联系人:王先生

## Test Report

No. CANEC1504269101

Date: 01 Apr 2015

Page 1 of 8

SHEN ZHEN HUIYUNHAI TECH. CO.,LTD

3F,A BUILDING,SHUNCHENGJI INDUSTRIAL AREA,DAHE ROAD,QINGHU, LONGHUA,SHENZHEN,CHINA

The following sample(s) was/were submitted and identified on behalf of the clients as : FLAME RESISTANT PET SLEEVING

SGS Job No. : CP15-014478 - SZ

Model No. : 723025

Date of Sample Received : 26 Mar 2015

Testing Period : 26 Mar 2015 - 01 Apr 2015

Test Requested : Selected test(s) as requested by client.

Test Method : Please refer to next page(s).

Test Results : Please refer to next page(s).

Conclusion : Based on the performed tests on submitted sample(s), the results of Lead, Mercury, Cadmium, Hexavalent chromium, Polybrominated biphenyls (PBBs), Polybrominated diphenyl ethers (PBDEs) comply with the limits as set by RoHS Directive 2011/65/EU Annex II; recasting 2002/95/EC.

Signed for and on behalf of  
SGS-CSTC Standards Technical Services Co., Ltd. Guangzhou Branch



Almay Gao  
Approved Signatory



This document is issued by the Company subject to its General Conditions of Service printed overleaf, available on request or accessible at <http://www.sgs.com/en/Terms-and-Conditions.aspx> and, for electronic format documents, subject to Terms and Conditions for Electronic Documents at <http://www.sgs.com/en/Terms-and-Conditions/Terms-e-Documents.aspx>. Attention is drawn to the limitation of liability, indemnification and jurisdiction issues defined therein. Any holder of this document is advised that information contained hereon reflects the Company's findings at the time of its intervention only and within the limits of Client's instructions, if any. The Company's sole responsibility is to its Client and this document does not exonerate parties to a transaction from exercising all their rights and obligations under the transaction documents. This document cannot be reproduced except in full, without prior written approval of the Company. Any unauthorized alteration, forgery or falsification of the content or appearance of this document is unlawful and offenders may be prosecuted to the fullest extent of the law. Unless otherwise stated the results shown in this test report refer only to the sample(s) tested.

Attention: To check the authenticity of testing /inspection report & certificate, please contact us at telephone: (86-755) 8307 1443, or email: CN.Doccheck@sgs.com

198 Kezhu Road, Sciencetech Park Guangzhou Economic & Technology Development District, Guangzhou, China 510663 t (86-20) 82155555 f (86-20) 82075113 www.sgsgroup.com.cn  
中国·广州·经济技术开发区科学城科珠路198号 邮编: 510663 t (86-20) 82155555 f (86-20) 82075113 e sgs.china@sgs.com

# Test Report

No. CANEC1504269101

Date: 01 Apr 2015

Page 2 of 8

Test Results :

Test Part Description :

Specimen No.	SGS Sample ID	Description
SN1	CAN15-042691.001	Black material

Remarks :

- (1) 1 mg/kg = 1 ppm = 0.0001%
- (2) MDL = Method Detection Limit
- (3) ND = Not Detected ( < MDL )
- (4) "-" = Not Regulated

**RoHS Directive 2011/65/EU**

- Test Method :
- (1)With reference to IEC 62321-5:2013, determination of Cadmium by ICP-OES.
  - (2)With reference to IEC 62321-5:2013, determination of Lead by ICP-OES.
  - (3)With reference to IEC 62321-4:2013, determination of Mercury by ICP-OES.
  - (4)With reference to IEC 62321:2008, determination of Hexavalent Chromium by Colorimetric Method using UV-Vis.
  - (5)With reference to IEC 62321:2008, determination of PBBs and PBDEs by GC-MS.

<u>Test Item(s)</u>	<u>Limit</u>	<u>Unit</u>	<u>MDL</u>	<u>001</u>
Cadmium (Cd)	100	mg/kg	2	ND
Lead (Pb)	1,000	mg/kg	2	5
Mercury (Hg)	1,000	mg/kg	2	ND
Hexavalent Chromium (CrVI)	1,000	mg/kg	2	ND
Sum of PBBs	1,000	mg/kg	-	ND
Monobromobiphenyl	-	mg/kg	5	ND
Dibromobiphenyl	-	mg/kg	5	ND
Tribromobiphenyl	-	mg/kg	5	ND
Tetrabromobiphenyl	-	mg/kg	5	ND
Pentabromobiphenyl	-	mg/kg	5	ND
Hexabromobiphenyl	-	mg/kg	5	ND
Heptabromobiphenyl	-	mg/kg	5	ND
Octabromobiphenyl	-	mg/kg	5	ND
Nonabromobiphenyl	-	mg/kg	5	ND
Decabromobiphenyl	-	mg/kg	5	ND
Sum of PBDEs	1,000	mg/kg	-	ND
Monobromodiphenyl ether	-	mg/kg	5	ND



This document is issued by the Company subject to its General Conditions of Service printed overleaf, available on request or accessible at <http://www.sgs.com/en/Terms-and-Conditions.aspx> and, for electronic format documents, subject to Terms and Conditions for Electronic Documents at <http://www.sgs.com/en/Terms-and-Conditions/Terms-e-Documents.aspx>. Attention is drawn to the limitation of liability, indemnification and jurisdiction issues defined therein. Any holder of this document is advised that information contained hereon reflects the Company's findings at the time of its intervention only and within the limits of Client's instructions, if any. The Company's sole responsibility is to its Client and this document does not exonerate parties to a transaction from exercising all their rights and obligations under the transaction documents. This document cannot be reproduced except in full, without prior written approval of the Company. Any unauthorized alteration, forgery or falsification of the content or appearance of this document is unlawful and offenders may be prosecuted to the fullest extent of the law. Unless otherwise stated the results shown in this test report refer only to the sample(s) tested.

Attention: To check the authenticity of testing /inspection report & certificate, please contact us at telephone: (86-755) 8307 1443, or email: [CN.Doccheck@sgs.com](mailto:CN.Doccheck@sgs.com)

198 Kezhu Road, Sciencetech Park Guangzhou Economic & Technology Development District, Guangzhou, China 510663 t (86-20) 82155555 f (86-20) 82075113 www.sgsgroup.com.cn  
中国·广州·经济技术开发区科学城科珠路198号 邮编: 510663 t (86-20) 82155555 f (86-20) 82075113 e [sgs.china@sgs.com](mailto:sgs.china@sgs.com)

## Test Report

No. CANEC1504269101

Date: 01 Apr 2015

Page 3 of 8

<u>Test Item(s)</u>	<u>Limit</u>	<u>Unit</u>	<u>MDL</u>	<u>001</u>
Dibromodiphenyl ether	-	mg/kg	5	ND
Tribromodiphenyl ether	-	mg/kg	5	ND
Tetrabromodiphenyl ether	-	mg/kg	5	ND
Pentabromodiphenyl ether	-	mg/kg	5	ND
Hexabromodiphenyl ether	-	mg/kg	5	ND
Heptabromodiphenyl ether	-	mg/kg	5	ND
Octabromodiphenyl ether	-	mg/kg	5	ND
Nonabromodiphenyl ether	-	mg/kg	5	ND
Decabromodiphenyl ether	-	mg/kg	5	ND

### Notes :

(1) The maximum permissible limit is quoted from the directive 2011/65/EU, Annex II.

### Halogen

Test Method : With reference to EN 14582: 2007, analysis was performed by Ion Chromatograph (IC).

<u>Test Item(s)</u>	<u>Unit</u>	<u>MDL</u>	<u>001</u>
Fluorine (F)	mg/kg	50	ND
Chlorine (Cl)	mg/kg	50	ND
Bromine (Br)	mg/kg	50	ND
Iodine (I)	mg/kg	50	ND

### Phthalate

Test Method : Determination of phthalates by GC-MS based on EN 14372:2004.

<u>Test Item(s)</u>	<u>CAS NO.</u>	<u>Unit</u>	<u>MDL</u>	<u>001</u>
Dibutyl Phthalate (DBP)	84-74-2	%(w/w)	0.003	ND
Benzylbutyl Phthalate (BBP)	85-68-7	%(w/w)	0.003	ND
Bis(2-ethylhexyl) Phthalate (DEHP)	117-81-7	%(w/w)	0.003	ND



This document is issued by the Company subject to its General Conditions of Service printed overleaf, available on request or accessible at <http://www.sgs.com/en/Terms-and-Conditions.aspx> and, for electronic format documents, subject to Terms and Conditions for Electronic Documents at <http://www.sgs.com/en/Terms-and-Conditions/Terms-e-Documents.aspx>. Attention is drawn to the limitation of liability, indemnification and jurisdiction issues defined therein. Any holder of this document is advised that information contained hereon reflects the Company's findings at the time of its intervention only and within the limits of Client's instructions, if any. The Company's sole responsibility is to its Client and this document does not exonerate parties to a transaction from exercising all their rights and obligations under the transaction documents. This document cannot be reproduced except in full, without prior written approval of the Company. Any unauthorized alteration, forgery or falsification of the content or appearance of this document is unlawful and offenders may be prosecuted to the fullest extent of the law. Unless otherwise stated the results shown in this test report refer only to the sample(s) tested.

Attention: To check the authenticity of testing / inspection report & certificate, please contact us at telephone: (86-755) 8307 1443, or email: [CN.Doccheck@sgs.com](mailto:CN.Doccheck@sgs.com)

## Test Report

No. CANEC1504269101

Date: 01 Apr 2015

Page 4 of 8

<u>Test Item(s)</u>	<u>CAS NO.</u>	<u>Unit</u>	<u>MDL</u>	<u>001</u>
Diisobutyl Phthalate (DIBP)	84-69-5	%(w/w)	0.003	ND

### Notes :

Reference Information: Directive 2011/65/EU recasting RoHS directive 2002/95/EC and the latest amending directive:

(1) Bis (2-ethylhexyl) phthalate (DEHP), Butyl benzyl phthalate (BBP), and Dibutyl phthalate (DBP) are considered as a priority for risk evaluation and substance restriction.

(2) Bis (2-ethylhexyl) phthalate (DEHP), Butyl benzyl phthalate (BBP), Dibutyl phthalate (DBP) and Diisobutyl Phthalates (DIBP) have been adopted in the draft of Commission Delegated Directive amending Annex II to Directive 2011/65/EU of the European Parliament, and the regulatory limit of each restricted substances should be 0.1%.



This document is issued by the Company subject to its General Conditions of Service printed overleaf, available on request or accessible at <http://www.sgs.com/en/Terms-and-Conditions.aspx> and, for electronic format documents, subject to Terms and Conditions for Electronic Documents at <http://www.sgs.com/en/Terms-and-Conditions/Terms-e-Documents.aspx>. Attention is drawn to the limitation of liability, indemnification and jurisdiction issues defined therein. Any holder of this document is advised that information contained hereon reflects the Company's findings at the time of its intervention only and within the limits of Client's instructions, if any. The Company's sole responsibility is to its Client and this document does not exonerate parties to a transaction from exercising all their rights and obligations under the transaction documents. This document cannot be reproduced except in full, without prior written approval of the Company. Any unauthorized alteration, forgery or falsification of the content or appearance of this document is unlawful and offenders may be prosecuted to the fullest extent of the law. Unless otherwise stated the results shown in this test report refer only to the sample(s) tested.

Attention: To check the authenticity of testing / inspection report & certificate, please contact us at telephone: (86-755) 8307 1443, or email: [CN.Doccheck@sgs.com](mailto:CN.Doccheck@sgs.com)

SGS-CTD Standards Technical Services Co., Ltd.  
Guangzhou Chemical Laboratory

198 Kezhu Road, Sciencetech Park Guangzhou Economic & Technology Development District, Guangzhou, China 510663 t (86-20) 82155555 f (86-20) 82075113 www.sgsgroup.com.cn  
中国·广州·经济技术开发区科学城科珠路198号 邮编: 510663 t (86-20) 82155555 f (86-20) 82075113 e [sgs.china@sgs.com](mailto:sgs.china@sgs.com)



ATTACHMENTS

RoHS Testing Flow Chart

- 1) Name of the person who made testing: Bruce Xiao / Sunny Hu
- 2) Name of the person in charge of testing: Bella Wang / Cutey Yu
- 3) These samples were dissolved totally by pre-conditioning method according to below flow chart (Cr<sup>6+</sup> and PBBs/PBDEs test method excluded).

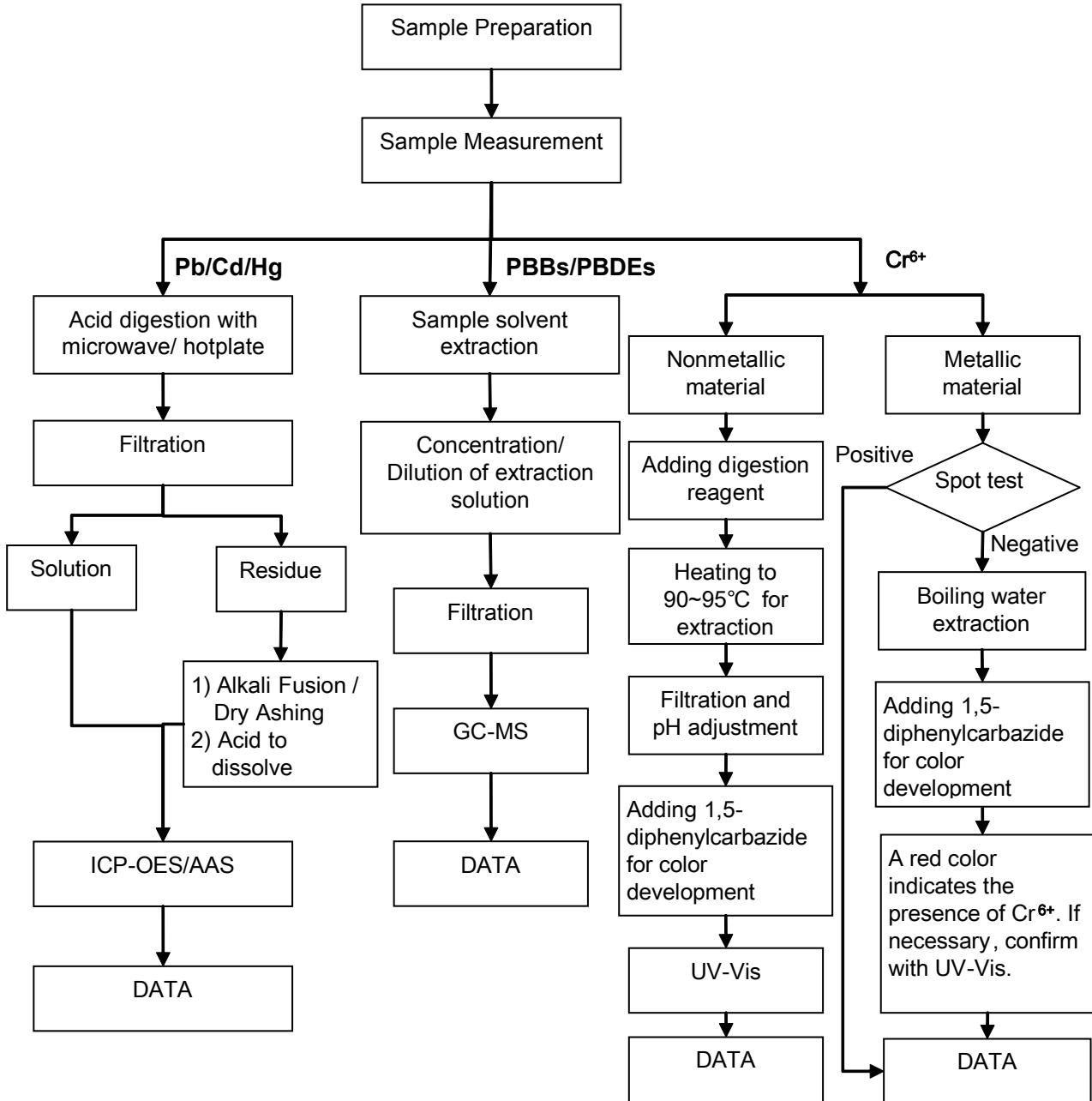

This document is issued by the Company subject to its General Conditions of Service printed overleaf, available on request or accessible at <http://www.sgs.com/en/Terms-and-Conditions.aspx> and, for electronic format documents, subject to Terms and Conditions for Electronic Documents at <http://www.sgs.com/en/Terms-and-Conditions/Terms-e-Documents.aspx>. Attention is drawn to the limitation of liability, indemnification and jurisdiction issues defined therein. Any holder of this document is advised that information contained hereon reflects the Company's findings at the time of its intervention only and within the limits of Client's instructions, if any. The Company's sole responsibility is to its Client and this document does not exonerate parties to a transaction from exercising all their rights and obligations under the transaction documents. This document cannot be reproduced except in full, without prior written approval of the Company. Any unauthorized alteration, forgery or falsification of the content or appearance of this document is unlawful and offenders may be prosecuted to the fullest extent of the law. Unless otherwise stated the results shown in this test report refer only to the sample(s) tested.

Attention: To check the authenticity of testing / inspection report & certificate, please contact us at telephone: (86-755) 8307 1443, or email: CN.Doccheck@sgs.com

198 Kezhu Road, Sciencetech Park Guangzhou Economic & Technology Development District, Guangzhou, China 510663 t (86-20) 82155555 f (86-20) 82075113 www.sgsgroup.com.cn  
 中国·广州·经济技术开发区科学城科珠路198号 邮编: 510663 t (86-20) 82155555 f (86-20) 82075113 e sgs.china@sgs.com



ATTACHMENTS

Phthalates Testing Flow Chart

- 1) Name of the person who made testing: Sunny Hu
- 2) Name of the person in charge of testing: Cutey Yu

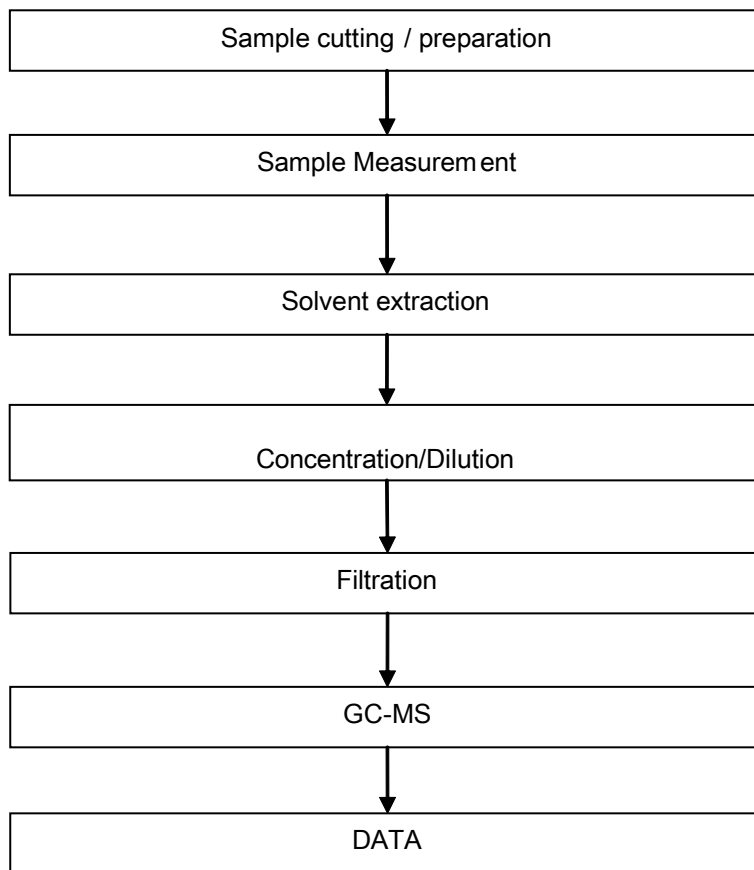

This document is issued by the Company subject to its General Conditions of Service printed overleaf, available on request or accessible at <http://www.sgs.com/en/Terms-and-Conditions.aspx> and, for electronic format documents, subject to Terms and Conditions for Electronic Documents at <http://www.sgs.com/en/Terms-and-Conditions/Terms-e-Documents.aspx>. Attention is drawn to the limitation of liability, indemnification and jurisdiction issues defined therein. Any holder of this document is advised that information contained hereon reflects the Company's findings at the time of its intervention only and within the limits of Client's instructions, if any. The Company's sole responsibility is to its Client and this document does not exonerate parties to a transaction from exercising all their rights and obligations under the transaction documents. This document cannot be reproduced except in full, without prior written approval of the Company. Any unauthorized alteration, forgery or falsification of the content or appearance of this document is unlawful and offenders may be prosecuted to the fullest extent of the law. Unless otherwise stated the results shown in this test report refer only to the sample(s) tested.

Attention: To check the authenticity of testing / inspection report & certificate, please contact us at telephone: (86-755) 8307 1443, or email: [CN.Doccheck@sgs.com](mailto:CN.Doccheck@sgs.com)

198 Kezhu Road, Sciencetech Park Guangzhou Economic & Technology Development District, Guangzhou, China 510663 t (86-20) 82155555 f (86-20) 82075113 www.sgsgroup.com.cn  
 中国·广州·经济技术开发区科学城科珠路198号 邮编: 510663 t (86-20) 82155555 f (86-20) 82075113 e [sgs.china@sgs.com](mailto:sgs.china@sgs.com)

ATTACHMENTS

Halogen Testing Flow Chart

- 1) Name of the person who made testing: Hanming Xiao
- 2) Name of the person in charge of testing: Bella Wang

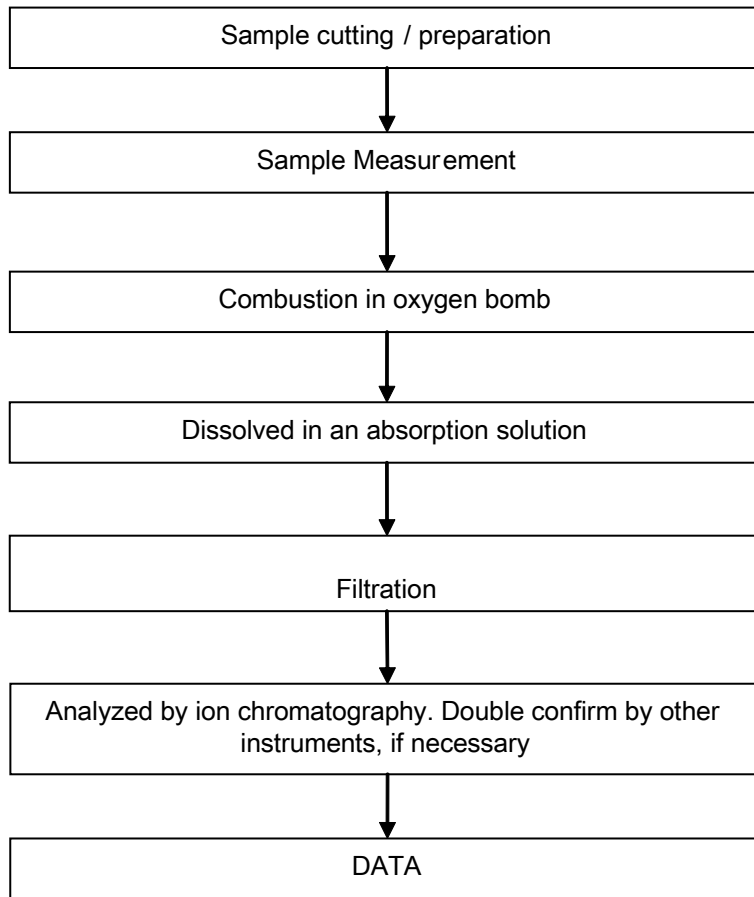

This document is issued by the Company subject to its General Conditions of Service printed overleaf, available on request or accessible at <http://www.sgs.com/en/Terms-and-Conditions.aspx> and, for electronic format documents, subject to Terms and Conditions for Electronic Documents at <http://www.sgs.com/en/Terms-and-Conditions/Terms-e-Documents.aspx>. Attention is drawn to the limitation of liability, indemnification and jurisdiction issues defined therein. Any holder of this document is advised that information contained hereon reflects the Company's findings at the time of its intervention only and within the limits of Client's instructions, if any. The Company's sole responsibility is to its Client and this document does not exonerate parties to a transaction from exercising all their rights and obligations under the transaction documents. This document cannot be reproduced except in full, without prior written approval of the Company. Any unauthorized alteration, forgery or falsification of the content or appearance of this document is unlawful and offenders may be prosecuted to the fullest extent of the law. Unless otherwise stated the results shown in this test report refer only to the sample(s) tested.

Attention: To check the authenticity of testing / inspection report & certificate, please contact us at telephone: (86-755) 8307 1443, or email: [CN.Doccheck@sgs.com](mailto:CN.Doccheck@sgs.com)

198 Kezhu Road, Sciencetech Park Guangzhou Economic & Technology Development District, Guangzhou, China 510663 t (86-20) 82155555 f (86-20) 82075113 www.sgsgroup.com.cn  
 中国·广州·经济技术开发区科学城科珠路198号 邮编: 510663 t (86-20) 82155555 f (86-20) 82075113 e [sgs.china@sgs.com](mailto:sgs.china@sgs.com)

Sample photo:

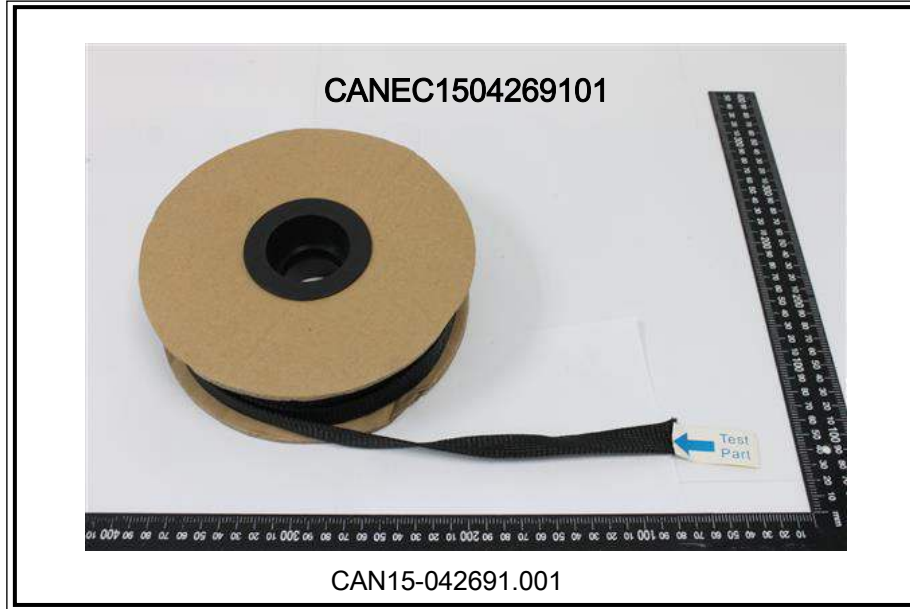

SGS authenticate the photo on original report only

\*\*\* End of Report \*\*\*



# TEST REPORT

Report No.: HX201401674-2

**Applicant:** DONG GUAN XIAN KANG ELECTRONIC PRODUCE CO.,LTD  
**Address:** THE SECOND INDUSTRIAL PARK.YAN WU DA LING SHAN TOWN.DONG GUAN CITY

**Report on the submitted sample(s) said to be:**

Name: Acetate tape  
Type/Model: -----  
Buyer: -----  
Supplier: -----

Date of Receipt: Mar.10, 2014      Test period: Mar.10, 2014 – Mar.13, 2014

**Test Request:** In accordance with RoHS Directive 2011/65/EU and its amendment directives.

**Test Result:** Please refer to following page(s).

**Conclusion:** Based on the performed test on submitted sample, the result(s) comply with the RoHS Directive 2011/65/EU and its amendment directives.

Tested by Ray Cao      Reviewed by Kevin Ren      Approved by Hailu Wang



This test report is responsible for the tested samples only. Without permission of the test center this test report is not permitted to be duplicated in extracts. The test report is invalid without the official stamp of GUANGZHOU GRG METROLOGY & TEST CO., LTD. The test report is invalid if altered. Objections to the test report must be submitted to GUANGZHOU GRG METROLOGY & TEST CO., LTD. within 15 days.

**GUANGZHOU GRG METROLOGY & TEST CO., LTD.**

Address: 163 Pingyun Road West of Huangpu Avenue Tianhe District Guangzhou City, 510656, P. R. China  
Tel: +86-020-38699572      FAX: +86-020-38698685      <http://www.grgtest.com>

# TEST REPORT

Report No.: HX201401674-2

**Sample description:**

1. Black adhesive cloth

**Test method:**

Test Item(s)	Test method	Measuring instrument	MDL
Lead (Pb)	IEC 62321:2008,section 10	ICP-OES/AAS	2mg/kg
Cadmium (Cd)	IEC 62321:2008,section 10	ICP-OES/AAS	2mg/kg
Mercury (Hg)	IEC 62321:2008,section 7	ICP-OES	2mg/kg
Hexavalent Chromium [Cr(VI)]	IEC 62321:2008,Annex C	UV-VIS	5mg/kg
PBBs & PBDEs	IEC 62321:2008,Annex A	GC-MS	10mg/kg

**Test result(s):**

Test Item	Result	Unit	RoHS Limit
	1		
Lead (Pb)	N.D.	mg/kg	1000
Cadmium (Cd)	N.D.	mg/kg	100
Mercury (Hg)	N.D.	mg/kg	1000
Hexavalent Chromium [Cr(VI)]	N.D.	mg/kg	1000

Test Item	Result	Unit	RoHS Limit
	1		
Sum of PBBs	N.D.	mg/kg	1000
Monobromobiphenyl	N.D.	mg/kg	---
Dibromobiphenyl	N.D.	mg/kg	---
Tribromobiphenyl	N.D.	mg/kg	---
Tetrabromobiphenyl	N.D.	mg/kg	---
Pentabromobiphenyl	N.D.	mg/kg	---
Hexabromobiphenyl	N.D.	mg/kg	---

**GUANGZHOU GRG METROLOGY & TEST CO., LTD.**

Address: 163 Pingyun Road West of Huangpu Avenue Tianhe District Guangzhou City, 510656, P. R. China  
 Tel: +86-020-38699572 FAX: +86-020-38698685 <http://www.grgtest.com>

# TEST REPORT

Report No.: HX201401674-2

Heptabromobiphenyl	N.D.	mg/kg	---
Octabromobiphenyl	N.D.	mg/kg	---
Nonabromobiphenyl	N.D.	mg/kg	---
Decabromobiphenyl	N.D.	mg/kg	---
Sum of PBDEs	N.D.	mg/kg	1000
Mono-bromodiphenyl ether	N.D.	mg/kg	---
Dibromodiphenyl ether	N.D.	mg/kg	---
Tribromodiphenyl ether	N.D.	mg/kg	---
Tetrabromodiphenyl ether	N.D.	mg/kg	---
Pentabromodiphenyl ether	N.D.	mg/kg	---
Hexabromodiphenyl ether	N.D.	mg/kg	---
Heptabromodiphenyl ether	N.D.	mg/kg	---
Octabromodiphenyl ether	N.D.	mg/kg	---
Nonabromodiphenyl ether	N.D.	mg/kg	---
Decabromodiphenyl ether	N.D.	mg/kg	---

- Remark:
- 1) mg/kg = ppm
  - 2) MDL = Method Detection Limit
  - 3) "N.D." = Not Detected (Below method detection limit)

## Test Process for Pb / Cd

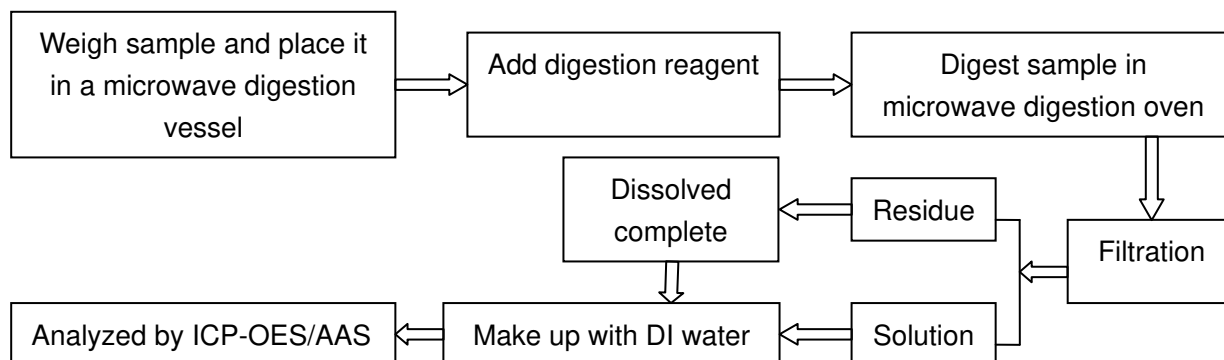

### GUANGZHOU GRG METROLOGY & TEST CO., LTD.

Address: 163 Pingyun Road West of Huangpu Avenue Tianhe District Guangzhou City, 510656, P. R. China  
 Tel: +86-020-38699572 FAX: +86-020-38698685 <http://www.grgtest.com>



### Test Process for Hg

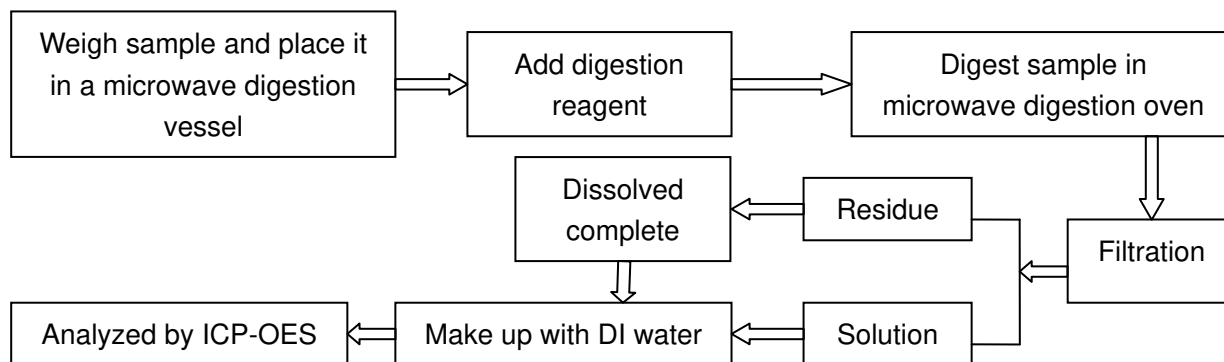

### Test Process for Cr (VI)

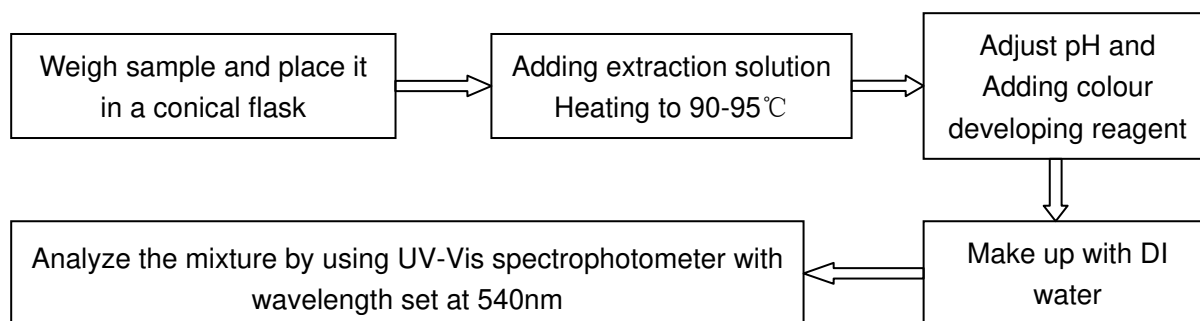

### Test Process for PBBs & PBDEs

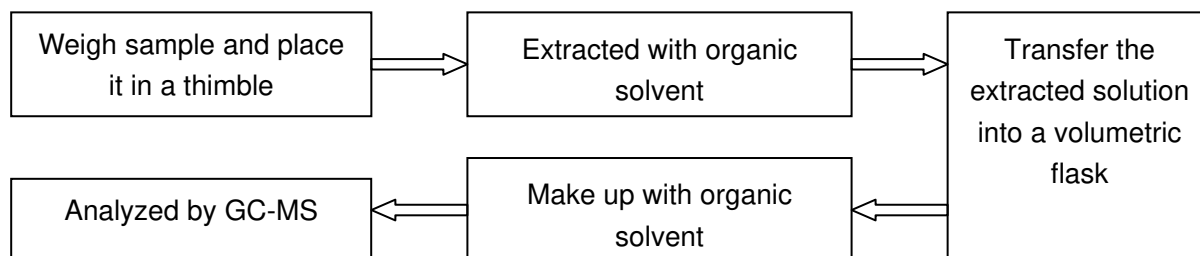

**GUANGZHOU GRG METROLOGY & TEST CO., LTD.**

Address: 163 Pingyun Road West of Huangpu Avenue Tianhe District Guangzhou City, 510656, P. R. China  
 Tel: +86-020-38699572 FAX: +86-020-38698685 <http://www.grgtest.com>

# TEST REPORT

Report No.: HX201401674-2

Photo of Sample

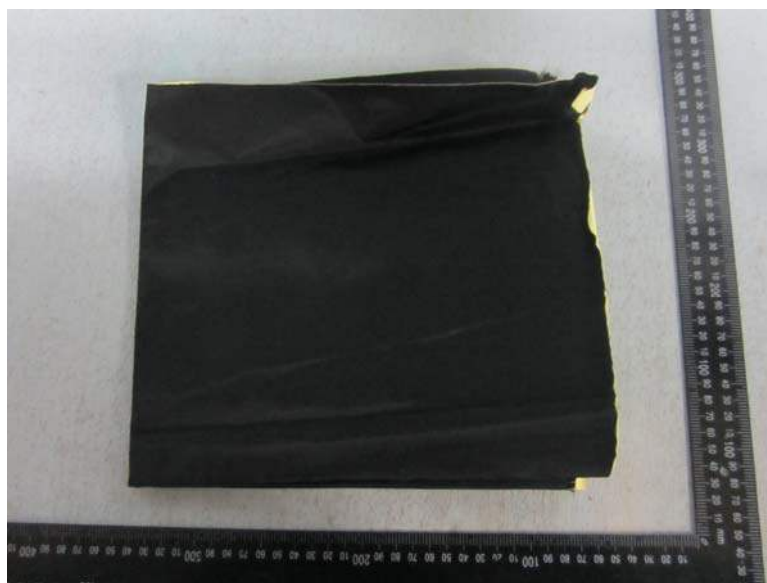

-----End of Report-----

**GUANGZHOU GRG METROLOGY & TEST CO., LTD.**

Address: 163 Pingyun Road West of Huangpu Avenue Tianhe District Guangzhou City, 510656, P. R. China  
Tel: +86-020-38699572 FAX: +86-020-38698685 <http://www.grgtest.com>