

HWS SERIES

Single Output 15W-1800W

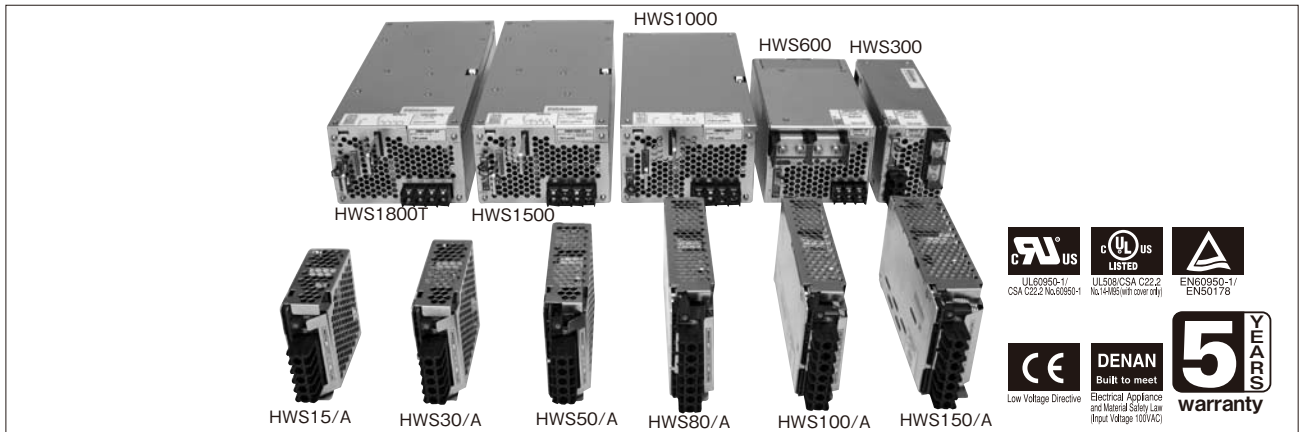

Features

- Environmentally-friendly: Conforming to RoHS directives
High-efficiency technology reduces power loss by heat generation. Fan stopping in power-off by external control realizes silence and energy saving.
- Easy to use: All models in the same height of 82mm. Mountable in 2U-height racks without dead space.
- Safety and reliability: "Safety terminal" covering current flowing part secures safety for users. "No screw-dropping" design prevents from losing screws during maintenance operation.
- HWS1500-48 realizes as high efficiency as 90%. Synchronous rectifier circuit improved efficiency of low voltage models by over 10% (HWS150-5).

Model naming method

[HWS15-150]

HWS 50 - 5 / □ □

Series name Output power

- Blank: Without cover
 - A: With cover
 - R: Remote ON/OFF control (HWS15 & HWS30 excluded)
 - RA: Remote ON/OFF control, with cover (HWS15 & HWS30 excluded)
 - ADIN: DIN rail mountable (24Vout of 15-150W models with cover only)
- Note: Requesting approval of safety standards should be made with HWS**-24/A.

Nominal output voltage
ex. 3: 3.3V, 5: 5V, 48: 48V

[HWS300-1800]

HWS 300 - 5 / □ □

Series name Output power

- Blank: With cover, forced air cooling with built-in fan
- PV: Output voltage adjustable by external voltage 12Vout+ models of HWS300, 600 only. (Supported by standard models of HWS1000 and above.)

Nominal output voltage
ex. 3: 3.3V, 5: 5V, 48: 48V

Applications



Conformity to RoHS Directive

This means that, in conformity with EU Directive 2002/95/EC, lead, cadmium, mercury, hexavalent chromium, and specific bromine-based flame retardants, PBB and PBDE, have not been used, except for exempted applications.

Product Line up

| Output Voltage | 15W | | 30W | | 50W | | 80W | | 100W | | 150W | |
|----------------|----------------|----------|----------------|----------|----------------|----------|----------------|----------|----------------|-----------|----------------|-----------|
| | Output Current | Model | Output Current | Model | Output Current | Model | Output Current | Model | Output Current | Model | Output Current | Model |
| 3.3V | 3A | HWS15-3 | 6A | HWS30-3 | 10A | HWS50-3 | 16A | HWS80-3 | 20A | HWS100-3 | 30A | HWS150-3 |
| 5V | 3A | HWS15-5 | 6A | HWS30-5 | 10A | HWS50-5 | 16A | HWS80-5 | 20A | HWS100-5 | 30A | HWS150-5 |
| 12V | 1.3A | HWS15-12 | 2.5A | HWS30-12 | 4.3A | HWS50-12 | 6.7A | HWS80-12 | 8.5A | HWS100-12 | 13A | HWS150-12 |
| 15V | 1A | HWS15-15 | 2A | HWS30-15 | 3.5A | HWS50-15 | 5.4A | HWS80-15 | 7A | HWS100-15 | 10A | HWS150-15 |
| 24V | 0.65A | HWS15-24 | 1.3A | HWS30-24 | 2.2A | HWS50-24 | 3.4A | HWS80-24 | 4.5A | HWS100-24 | 6.5A | HWS150-24 |
| 48V | 0.33A | HWS15-48 | 0.65A | HWS30-48 | 1.1A | HWS50-48 | 1.7A | HWS80-48 | 2.1 | HWS100-48 | 3.3A | HWS150-48 |

| Output Voltage | 300W | | 600W | | 1000W | | 1500W | | 1800W | |
|----------------|-----------------------|-----------|-----------------------|-----------|-----------------------|------------|---------------------------|------------|-----------------------|------------|
| | Output Current (Peak) | Model | Output Current (Peak) | Model | Output Current (Peak) | Model | Output Current (Peak) (*) | Model | Output Current (Peak) | Model |
| 3.3V | 60A | HWS300-3 | 120A | HWS600-3 | 200A | HWS1000-3 | — | — | 300A | HWS1800-3 |
| 5V | 60A | HWS300-5 | 120A | HWS600-5 | 200A | HWS1000-5 | — | — | 300A | HWS1800-5 |
| 6V | — | — | — | — | 167A | HWS1000-6 | — | — | 250A (300A) | HWS1800-6 |
| 7.5V | — | — | — | — | 134A (160A) | HWS1000-7 | — | — | 200A (240A) | HWS1800-7 |
| 12V | 27A | HWS300-12 | 53A | HWS600-12 | 88A (100A) | HWS1000-12 | 125A/125A (-) | HWS1500-12 | 125A (150A) | HWS1800-12 |
| 15V | 22A | HWS300-15 | 43A | HWS600-15 | 70A (80A) | HWS1000-15 | 100A/100A (-) | HWS1500-15 | 100A (120A) | HWS1800-15 |
| 24V | 14A | HWS300-24 | 27A (31A) | HWS600-24 | 44A (50A) | HWS1000-24 | 65A/70A (105A) | HWS1500-24 | 75A (105A) | HWS1800-24 |
| 36V | — | — | — | — | 29.3A (33.3A) | HWS1000-36 | 42A/46.5A (70A) | HWS1500-36 | 50A (70A) | HWS1800-36 |
| 48V | 7A | HWS300-48 | 13A | HWS600-48 | 22A (25A) | HWS1000-48 | 32A/32A (-) | HWS1500-48 | 37.5A (52.5A) | HWS1800-48 |
| 60V | — | — | — | — | 17.6A (20A) | HWS1000-60 | — | — | 30A (42A) | HWS1800-60 |

* All specifications are subject to change without notice.

(*) (100V系/200V系)

HWS15 Specifications

| ITEMS/UNITS | | MODEL | HWS15-3 | HWS15-5 | HWS15-12 | HWS15-15 | HWS15-24 | HWS15-48 | |
|-------------|--|----------------------|---|---|-------------|-------------|-------------|-------------|--|
| Input | Voltage Range (*2) | V | AC85 - 265 or DC120 - 370 | | | | | | |
| | Frequency (*2) | Hz | 47 - 63 | | | | | | |
| | Efficiency (100/200VAC)(typ) (*1) | % | 68 / 71 | 77 / 79 | 80 / 81 | | 82 / 83 | 80 / 80 | |
| | Current (100/200VAC)(typ) (*1) | A | 0.3 / 0.15 | 0.4 / 0.2 | | | | | |
| | Inrush Current (100/200VAC)(typ) (*3) | A | 14 / 28, Ta=25°C, cold start | | | | | | |
| | Leakage Current (*10) | mA | Less than 0.5. (0.2 (typ) at 100VAC / 0.4 (typ) at 230VAC) | | | | | | |
| Output | Nominal Voltage | VDC | 3.3 | 5 | 12 | 15 | 24 | 48 | |
| | Maximum Current | A | 3 | | 1.3 | 1 | 0.65 | 0.33 | |
| | Maximum Power | W | 10 | 15 | 15.6 | 15 | 15.6 | 15.8 | |
| | Maximum Line Regulation (*5) | mV | 20 | | 48 | 60 | 96 | 192 | |
| | Maximum Load Regulation (*6) | mV | 40 | | 96 | 120 | 192 | 384 | |
| | Temperature Coefficient | | Less than 0.02% / °C | | | | | | |
| | Maximum Ripple & Noise (0<Ta<70°C) (*4) | mVp-p | 120 | | 150 | | 200 | | |
| | Maximum Ripple & Noise (-10<Ta<0°C) (*4) | mVp-p | 160 | | 180 | | 240 | | |
| | Hold-up Time (typ) (*9) | ms | 20 | | | | | | |
| | Voltage Adjustable Range | VDC | 2.97 - 3.96 | 4.0 - 6.0 | 9.6 - 14.4 | 12.0 - 18.0 | 19.2 - 28.8 | 38.4 - 52.8 | |
| Function | Over Current Protection (*7) | A | >3.15 | | >1.36 | >1.05 | >0.68 | >0.34 | |
| | Over Voltage Protection (*8) | VDC | 4.13 - 4.95 | 6.25 - 7.25 | 15.0 - 17.4 | 18.8 - 21.8 | 30.0 - 34.8 | 55.2 - 64.8 | |
| | Remote Sensing | | - | | | | | | |
| | Remote ON/OFF Control | | - | | | | | | |
| | Parallel Operation | | - | | | | | | |
| | Series Operation | | Possible | | | | | | |
| | Line DIP | | Built to meet SEMI-F47 (200VAC Line only) | | | | | | |
| | Operating Temperature (*11) | °C | -10 to +70 (-10 to +50: 100%, +60: 60%, +70: 20%) | | | | | | |
| | Storage Temperature | °C | -30 to +85 | | | | | | |
| | Operating Humidity | %RH | 30 - 90 (No dewdrop) | | | | | | |
| Environment | Storage Humidity | %RH | 10 - 95 (No dewdrop) | | | | | | |
| | Vibration | | At no operating, 10 - 55Hz (sweep for 1min) 19.6m/s² constant, X, Y, Z 1hour each. | | | | | | |
| | Shock (In package) | | Less than 196.1m/s² | | | | | | |
| | Cooling | | Convection cooling | | | | | | |
| | Isolation | Withstand Voltage | | Input - FG : 2kVAC (20mA), Input - Output : 3kVAC (20mA) Output - FG : 500VAC (100mA) for 1min | | | | | |
| | | Isolation Resistance | | More than 100MΩ at 25°C and 70%RH Output - FG : 500VDC | | | | | |
| Standards | Safety Standards (*12) | | Approved by UL60950-1, UL508 (24V model only), CSA C22.2 No.60950-1, CSA C22.2 No.14-M95 (24V model only), EN60950-1, EN50178 Built to meet UL508, DENAN | | | | | | |
| | PFHC | | Built to meet IEC61000-3-2 | | | | | | |
| | EMI | | Built to meet EN55011/EN55022-B, FCC-B, VCCI-B | | | | | | |
| | Immunity | | Built to meet IEC61000-4-2(Level 2,3), -3(Level 3), -4(Level 3), -5(Level 3,4), -6(Level 3), -8(Level 4), -11 | | | | | | |
| Mechanical | Weight (typ) | g | 180 | | | | | | |
| | Size (W x H x D) | mm | 26.5 x 82 x 80 (Refer to outline drawing) | | | | | | |

(*1) At 100/200VAC, Ta=25°C and maximum output power.

(*2) For cases where conformance to various safety specs (UL, CSA, EN) are required, to be described as 100 - 240VAC (50/60Hz).

(*3) Not applicable for the in-rush current to noise filter for less than 0.2ms.

(*4) Measure with JEITA RC-9131A probe, bandwidth of scope :100MHz.

For start up at low ambient temperature and low input voltage, output ripple noise might not meet specification. However, there is no overshoot at start up and output ripple noise specification can be met after one second.

(*5) 85 - 265VAC, constant load.

(*6) No load-Full load, constant input voltage.

(*7) Foldback current limit with automatic recovery. Not operate at over load or dead short condition for more than 30 seconds.

(*8) OVP circuit will shutdown output, manual reset (Re power on).

(*9) At 100/200VAC, Ta=25°C, nominal output voltage and maximum output current.

(*10) Measured by the each measuring method of UL, CSA, EN and DENAN (at 60Hz).

(*11) Ratings - Derating at standard mounting.

- Load (%) is percent of maximum output power or maximum output current, whichever is greater.

- As for other mountings, refer to derating curve.

(*12) As for DENAN, built to meet at 100VAC.

● Recommended EMC Filter

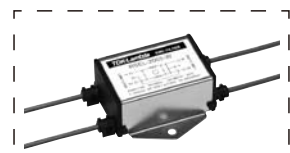

RSEL-2001W

Please refer to "TDK-Lambda EMC Filters" catalog.

Outline Drawing

[HWS15]

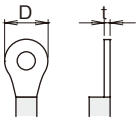
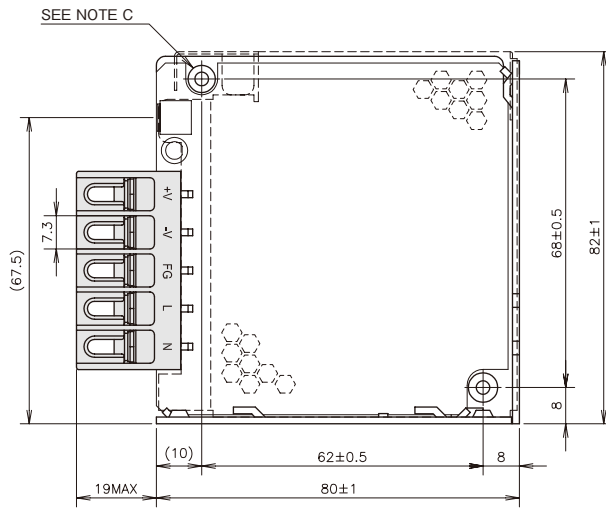
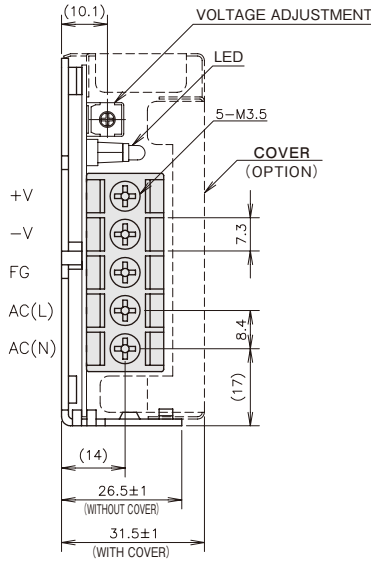

| Recommended Solderless Terminal | | |
|---------------------------------|---------|-----------|
| D (max) | t (max) | Qty (max) |
| 6.8mm | 0.8mm | 2 pcs |

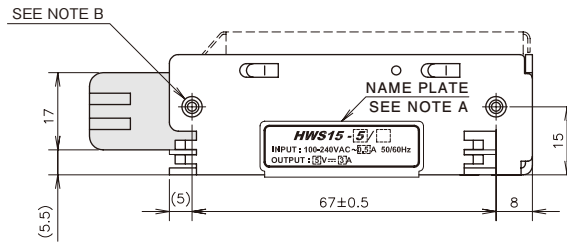

NOTES

- A : MODEL NAME, INPUT VOLTAGE RANGE, NOMINAL OUTPUT VOLTAGE, MAXIMUM OUTPUT CURRENT AND COUNTRY OF MANUFACTURE ARE SHOWN HERE IN ACCORDANCE WITH THE SPECIFICATIONS.
- B : M3 EMBOSSED, TAPPED AND COUNTERSUNK HOLES (2) FOR CUSTOMER CHASSIS MOUNTING. SCREWS MUST NOT PROTRUDE INTO POWER SUPPLY BY MORE THAN 6mm.
- C : M3 TAPPED HOLES (2) FOR CUSTOMER CHASSIS MOUNTING. SCREWS MUST NOT PROTRUDE INTO POWER SUPPLY BY MORE THAN 6mm.

unit: mm

HWS

Output Derating

HWS15

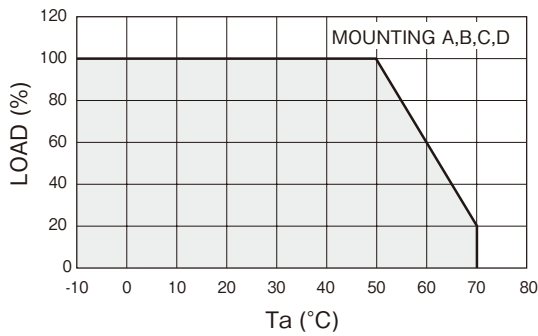

HWS15/A

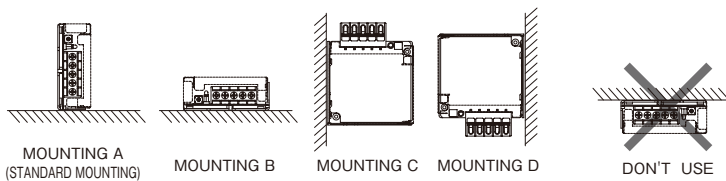
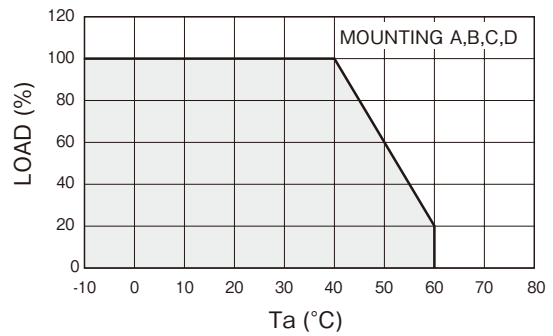

HWS30 Specifications

| ITEMS/UNITS | | MODEL | HWS30-3 | HWS30-5 | HWS30-12 | HWS30-15 | HWS30-24 | HWS30-48 | |
|--------------------|---|-----------------------------|---|---|-------------|-------------|-------------|-------------|--|
| Input | Voltage Range (*2) | V | AC85 - 265 or DC120 - 370 | | | | | | |
| | Frequency (*2) | Hz | 47 - 63 | | | | | | |
| | Efficiency (100/200VAC)(typ) (*1) | % | 70 / 73 | 77 / 80 | 81 / 83 | | 83 / 86 | 82 / 83 | |
| | Current (100/200VAC)(typ) (*1) | A | 0.6 / 0.3 | | 0.8 / 0.4 | | | | |
| | Inrush Current (100/200VAC)(typ)(*3) | A | 14 / 28, Ta=25°C, cold start | | | | | | |
| | Leakage Current (*10) | mA | Less than 0.5. (0.2 (typ) at 100VAC / 0.4 (typ) at 230VAC) | | | | | | |
| Output | Nominal Voltage | VDC | 3.3 | 5 | 12 | 15 | 24 | 48 | |
| | Maximum Current | A | 6 | | 2.5 | 2 | 1.3 | 0.65 | |
| | Maximum Power | W | 20 | | 30 | | 31.2 | | |
| | Maximum Line Regulation (*5) | mV | 20 | | 48 | 60 | 96 | 192 | |
| | Maximum Load Regulation (*6) | mV | 40 | | 96 | 120 | 192 | 384 | |
| | Temperature Coefficient | | Less than 0.02% / °C | | | | | | |
| | Maximum Ripple & Noise (0≤Ta≤70°C) (*4) | mVp-p | 120 | | 150 | | 200 | | |
| | Maximum Ripple & Noise (-10≤Ta< 0°C) (*4) | mVp-p | 160 | | 180 | | 240 | | |
| | Hold-up Time (typ) (*9) | ms | 20 | | | | | | |
| Function | Voltage Adjustable Range | VDC | 2.97 - 3.96 | 4.0 - 6.0 | 9.6 - 14.4 | 12.0 - 18.0 | 19.2 - 28.8 | 38.4 - 52.8 | |
| | Over Current Protection (*7) | A | >6.3 | | >2.62 | >2.1 | >1.36 | >0.68 | |
| | Over Voltage Protection (*8) | VDC | 4.13 - 4.95 | 6.25 - 7.25 | 15.0 - 17.4 | 18.8 - 21.8 | 30.0 - 34.8 | 55.2 - 64.8 | |
| | Remote Sensing | | - | | | | | | |
| | Remote ON/OFF Control | | - | | | | | | |
| | Parallel Operation | | - | | | | | | |
| | Series Operation | | Possible | | | | | | |
| | Line DIP | | Built to meet SEMI-F47 (200VAC Line only) | | | | | | |
| | Environment | Operating Temperature (*11) | °C | -10 to +70 (-10 to +50: 100%, +60: 60%, +70: 20%) | | | | | |
| | | Storage Temperature | °C | -30 to +85 | | | | | |
| Operating Humidity | | %RH | 30 - 90 (No dewdrop) | | | | | | |
| Storage Humidity | | %RH | 10 - 95 (No dewdrop) | | | | | | |
| Vibration | | | At no operating, 10 - 55Hz (sweep for 1min) 19.6m/s ² constant, X, Y, Z 1hour each. | | | | | | |
| Shock (In package) | | | Less than 196.1m/s ² | | | | | | |
| Cooling | | | Convection cooling | | | | | | |
| Isolation | Withstand Voltage | | Input - FG : 2kVAC (20mA), Input - Output : 3kVAC (20mA) Output - FG : 500VAC (100mA) for 1min | | | | | | |
| | Isolation Resistance | | More than 100MΩ at 25°C and 70%RH Output - FG : 500VDC | | | | | | |
| Standards | Safety Standards (*12) | | Approved by UL60950-1, UL508 (24V model only), CSA C22.2 No.60950-1, CSA C22.2 No.14-M95 (24V model only), EN60950-1, EN50178 Built to meet UL508, DENAN | | | | | | |
| | PFHC | | Built to meet IEC61000-3-2 | | | | | | |
| | EMI | | Built to meet EN55011/EN55022-B, FCC-B, VCCI-B | | | | | | |
| | Immunity | | Built to meet IEC61000-4-2(Level 2,3), -3(Level 3), -4(Level 3), -5(Level 3,4), -6(Level 3), -8(Level 4), -11 | | | | | | |
| Mechanical | Weight (typ) | g | 220 | | | | | | |
| | Size (W x H x D) | mm | 26.5 x 82 x 95 (Refer to outline drawing) | | | | | | |

(*1) At 100/200VAC, Ta=25°C and maximum output power.

(*2) For cases where conformance to various safety specs (UL, CSA, EN) are required, to be described as 100 - 240VAC (50/60Hz).

(*3) Not applicable for the in-rush current to noise filter for less than 0.2ms.

(*4) Measure with JEITA RC-9131A probe, bandwidth of scope :100MHz.

For start up at low ambient temperature and low input voltage, output ripple noise might not meet specification. However, there is no overshoot at start up and output ripple noise specification can be met after one second.

(*5) 85 - 265VAC, constant load.

(*6) No load-Full load, constant input voltage.

(*7) Foldback current limit with automatic recovery. Not operate at over load or dead short condition for more than 30seconds.

(*8) OVP circuit will shutdown output, manual reset (re power on).

(*9) At 100/200VAC, Ta=25°C, nominal output voltage and maximum output current.

(*10) Measured by the each measuring method of UL, CSA, EN and DENAN (at 60Hz).

(*11) Ratings - Derating at standard mounting.

- Load (%) is percent of maximum output power or maximum output current, whichever is greater.
- As for other mountings, refer to derating curve.

(*12) As for DENAN, built to meet at 100VAC.

● Recommended EMC Filter



RSEL-2001W

Please refer to "TDK-Lambda EMC Filters" catalog.

Outline Drawing

[HWS30]

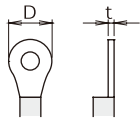
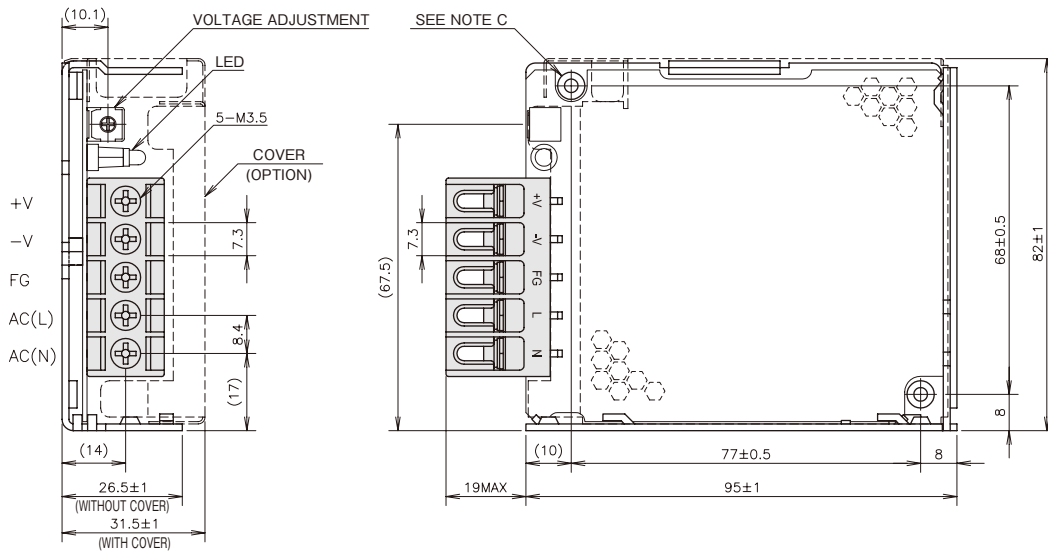

| Recommended Solderless Terminal | | |
|---------------------------------|---------|-----------|
| D (max) | t (max) | Qty (max) |
| 6.8mm | 0.8mm | 2 pcs |

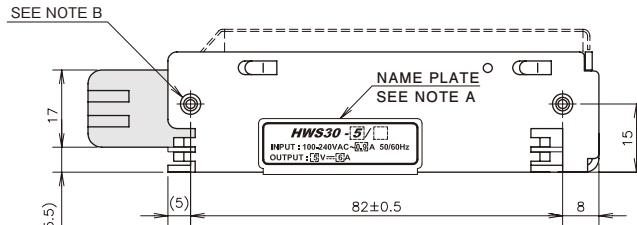

NOTES

unit: mm

- A: MODEL NAME, INPUT VOLTAGE RANGE, NOMINAL OUTPUT VOLTAGE, MAXIMUM OUTPUT CURRENT AND COUNTRY OF MANUFACTURE ARE SHOWN HERE IN ACCORDANCE WITH THE SPECIFICATIONS.
- B: M3 EMBOSSED, TAPPED AND COUNTERSUNK HOLES (2) FOR CUSTOMER CHASSIS MOUNTING. SCREWS MUST NOT PROTRUDE INTO POWER SUPPLY BY MORE THAN 6m/m.
- C: M3 TAPPED HOLES (2) FOR CUSTOMER CHASSIS MOUNTING. SCREWS MUST NOT PROTRUDE INTO POWER SUPPLY BY MORE THAN 6m/m.

Output Derating

HWS30

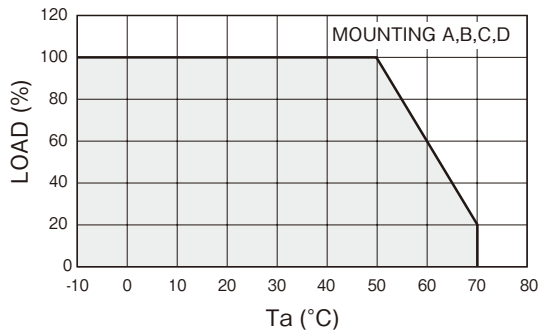

HWS30/A

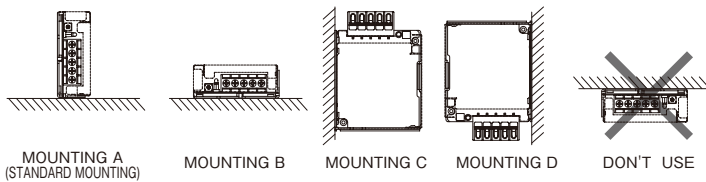
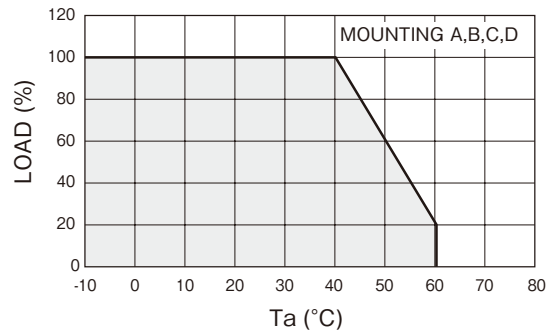

HWS50 Specifications

| ITEMS/UNITS | | MODEL | HWS50-3 | HWS50-5 | HWS50-12 | HWS50-15 | HWS50-24 | HWS50-48 |
|-------------|---|-------|---|-------------|-------------|-------------|-------------|-------------|
| Input | Voltage Range (*2) | V | AC85 - 265 or DC120 - 370 | | | | | |
| | Frequency (*2) | Hz | 47 - 63 | | | | | |
| | Power Factor (100/200VAC)(typ) (*1) | | 0.98 / 0.90 | 0.99 / 0.95 | | | | |
| | Efficiency (100/200VAC)(typ) (*1) | % | 76 / 78 | 82 / 84 | 81 / 83 | | 82 / 84 | 83 / 85 |
| | Current (100/200VAC)(typ) (*1) | A | 0.5 / 0.25 | 0.7 / 0.35 | | | | |
| | Inrush Current (100/200VAC)(typ) (*3) | A | 14 / 28, Ta=25°C, cold start | | | | | |
| | Leakage Current (*10) | mA | Less than 0.5. (0.2 (typ) at 100VAC / 0.4 (typ) at 230VAC) | | | | | |
| Output | Nominal Voltage | V | 3.3 | 5 | 12 | 15 | 24 | 48 |
| | Maximum Current | A | 10 | | | | | |
| | Maximum Power | W | 33 | 50 | 51.6 | 52.5 | 52.8 | |
| | Maximum Line Regulation (*5) | mV | 20 | | 48 | 60 | 96 | 192 |
| | Maximum Load Regulation (*6) | mV | 40 | | 96 | 120 | 192 | 384 |
| | Temperature Coefficient | | Less than 0.02% /°C | | | | | |
| | Maximum Ripple & Noise (0≤Ta≤70°C) (*4) | mVp-p | 120 | | 150 | | 200 | |
| | Maximum Ripple & Noise (-10≤Ta< 0°C) (*4) | mVp-p | 160 | | 180 | | 240 | |
| | Hold-up Time (typ) (*9) | ms | 20 | | | | | |
| | Voltage Adjustable Range | VDC | 2.97 - 3.96 | 4.0 - 6.0 | 9.6 - 14.4 | 12.0 - 18.0 | 19.2 - 28.8 | 38.4 - 52.8 |
| Function | Over Current Protection (*7) | A | >10.5 | | >4.51 | >3.67 | >2.31 | >1.15 |
| | Over Voltage Protection (*8) | V | 4.13 - 4.95 | 6.25 - 7.25 | 15.0 - 17.4 | 18.8 - 21.8 | 30.0 - 34.8 | 55.2 - 64.8 |
| | Remote Sensing | | - | | | | | |
| | Remote ON/OFF Control | | - | | | | | |
| | Parallel Operation | | - | | | | | |
| | Series Operation | | Possible | | | | | |
| | Line DIP | | Built to meet SEMI-F47 (200VAC Line only) | | | | | |
| Environment | Operating Temperature (*11) | °C | -10 to +70 (-10 to +50: 100%, +60: 60%, +70: 20%) | | | | | |
| | Storage Temperature | °C | -30 to +85 | | | | | |
| | Operating Humidity | %RH | 30 - 90 (No dewdrop) | | | | | |
| | Storage Humidity | %RH | 10 - 95 (No dewdrop) | | | | | |
| | Vibration | | At no operating, 10 - 55Hz (sweep for 1min) 19.6m/s ² constant, X, Y, Z 1hour each. | | | | | |
| | Shock (In package) | | Less than 196.1m/s ² | | | | | |
| | Cooling | | Convection cooling | | | | | |
| Isolation | Withstand Voltage | | Input - FG : 2kVAC (20mA), Input - Output : 3kVAC (20mA) Output - FG : 500VAC (100mA) for 1min | | | | | |
| | Isolation Resistance | | More than 100MΩ at 25°C and 70%RH Output - FG : 500VDC | | | | | |
| Standards | Safety Standards (*12) | | Approved by UL60950-1, UL508 (24V model only), CSA C22.2 No.60950-1, CSA C22.2 No.14-M95 (24V model only), EN60950-1, EN50178 Built to meet DENAN | | | | | |
| | PFHC | | Built to meet IEC61000-3-2 | | | | | |
| | EMI | | Built to meet EN55011/EN55022-B, FCC-B, VCCI-B | | | | | |
| Mechanical | Immunity | | Built to meet IEC61000-4-2(Level 2,3), -3(Level 3), -4(Level 3), -5(Level 3,4), -6(Level 3), -8(Level 4), -11 | | | | | |
| | Weight (typ) | g | 280 | | | | | |
| | Size (W x H x D) | mm | 26.5 x 82 x 120 (Refer to outline drawing) | | | | | |

- (*1) At 100/200VAC, Ta=25°C and maximum output power.
- (*2) For cases where conformance to various safety specs (UL, CSA, EN) are required, to be described as 100 - 240VAC (50/60Hz).
- (*3) Not applicable for the in-rush current to noise filter for less than 0.2ms.
- (*4) Measure with JEITA RC-9131A probe, bandwidth of scope : 100MHz.
- (*5) 85 - 265VAC, constant load.
- (*6) No load-full load, constant input voltage.
- (*7) Constant current limit and hiccup with automatic recovery. Not operate at over load or dead short condition for more than 30 seconds.
- (*8) OVP circuit will shutdown output, manual reset (re power on).
- (*9) At 100/200VAC, nominal output voltage and maximum output current.
- (*10) Measured by the each measuring method of UL, CSA, EN and DENAN (at 60Hz).
- (*11) Ratings - Derating at standard mounting.
- Load (%) is percent of maximum output power or maximum output current, whichever is greater.
- As for other mountings, refer to derating curve.
- (*12) As for DENAN, built to meet at 100VAC.

● Recommended EMC Filter

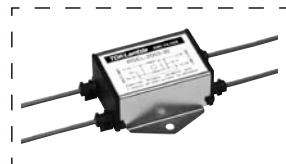

RSEL-2001W
Please refer to "TDK-Lambda EMC Filters" catalog.

Outline Drawing

[HWS50]

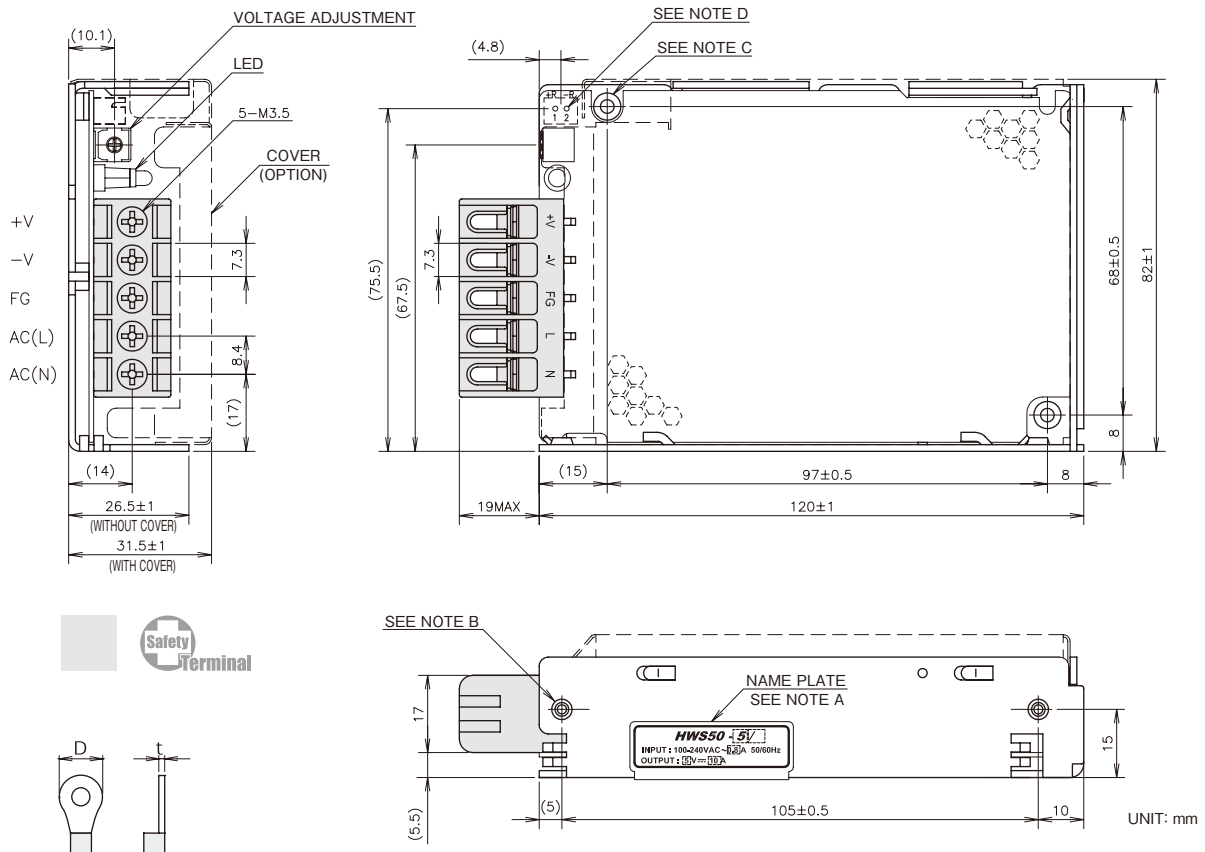

| Recommended Solderless Terminal | | |
|---------------------------------|---------|-----------|
| D (max) | t (max) | Qty (max) |
| 6.8mm | 0.8mm | 2 pcs |

NOTES

- A : MODEL NAME, OPTION, INPUT VOLTAGE RANGE, NOMINAL OUTPUT VOLTAGE, MAXIMUM OUTPUT CURRENT AND COUNTRY OF MANUFACTURE ARE SHOWN HERE IN ACCORDANCE WITH THE SPECIFICATIONS.
- B : M3 EMBOSSED, TAPPED AND COUNTERSUNK HOLES (2) FOR CUSTOMER CHASSIS MOUNTING. SCREWS MUST NOT PROTRUDE INTO POWER SUPPLY BY MORE THAN 6mm.
- C : M3 TAPPED HOLES (2) FOR CUSTOMER CHASSIS MOUNTING. SCREWS MUST NOT PROTRUDE INTO POWER SUPPLY BY MORE THAN 6mm.
- D : REMOTE ON/OFF CONTROL CONNECTOR --- OPTION B2B-XH-AM (JST)
MATCHING HOUSING : XHP-2 (JST)
MATCHING TERMINAL : BXH-001T-P0.6 (JST) OR SXH-001T-P0.6 (JST)
HAND CRIMPING TOOL : YC-110R (JST) OR YRS-110 (JST)

OPTIONAL MODELS

| MODEL | COVER | REMOTE ON/OFF CONTROL |
|--------------|-------|-----------------------|
| HWS50-* | | |
| HWS50-*/R/ | | ○ |
| HWS50-*/R/A/ | ○ | ○ |

Output Derating

HWS50

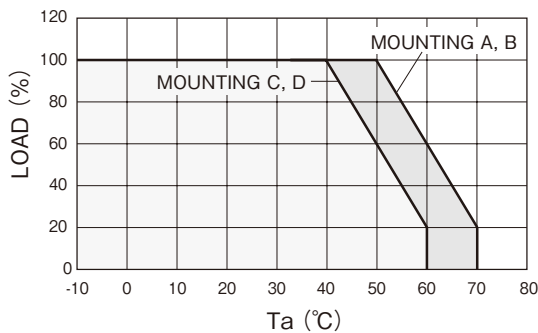

HWS50/A

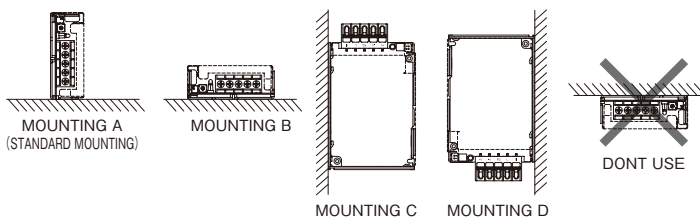
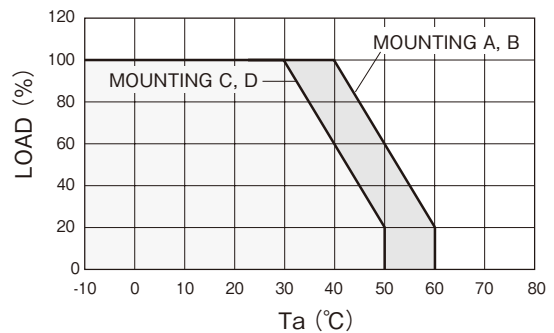

HWS80 Specifications

| ITEMS/UNITS | | MODEL | HWS80-3 | HWS80-5 | HWS80-12 | HWS80-15 | HWS80-24 | HWS80-48 |
|-----------------------|---|--|--|-------------|-------------|-------------|-------------|-------------|
| Input | Voltage Range (*2) | V | AC85 - 265 or DC120 - 370 | | | | | |
| | Frequency (*2) | Hz | 47 - 63 | | | | | |
| | Power Factor (100/200VAC)(typ) (*1) | | 0.98 / 0.90 | | 0.99 / 0.95 | | | |
| | Efficiency (100/200VAC)(typ) (*1) | % | 77 / 79 | | 82 / 85 | | 83 / 85 | 84 / 86 |
| | Current (100/200VAC)(typ) (*1) | A | 0.72 / 0.36 | | 1.04 / 0.52 | | | |
| | Inrush Current (100/200VAC)(typ) (*3) | A | 14 / 28, Ta=25°C, cold start | | | | | |
| Leakage Current (*10) | mA | Less than 0.5. (0.2 (typ) at 100VAC / 0.4 (typ) at 230VAC) | | | | | | |
| Output | Nominal Voltage | VDC | 3.3 | 5 | 12 | 15 | 24 | 48 |
| | Maximum Current | A | 16 | | | | | |
| | Maximum Power | W | 52.8 | 80 | 80.4 | 81 | 81.6 | |
| | Maximum Line Regulation (*5) | mV | 20 | | 48 | 60 | 96 | 192 |
| | Maximum Load Regulation (*6) | mV | 40 | | 96 | 120 | 192 | 384 |
| | Temperature Coefficient | | Less than 0.02% / °C | | | | | |
| | Maximum Ripple & Noise (0≤Ta≤70°C) (*4) | mVp-p | 120 | | 150 | | 200 | |
| | Maximum Ripple & Noise (-10≤Ta< 0°C) (*4) | mVp-p | 160 | | 180 | | 240 | |
| | Hold-up Time (typ) (*9) | ms | 20ms | | | | | |
| | Voltage Adjustable Range | VDC | 2.97 - 3.96 | 4.0 - 6.0 | 9.6 - 14.4 | 12.0 - 18.0 | 19.2 - 28.8 | 38.4 - 52.8 |
| Function | Over Current Protection (*7) | A | >16.8 | >16.8 | >7.04 | >5.67 | >3.57 | >1.79 |
| | Over Voltage Protection (*8) | VDC | 4.13 - 4.95 | 6.25 - 7.25 | 15.0 - 17.4 | 18.8 - 21.8 | 30.0 - 34.8 | 55.2 - 64.8 |
| | Remote Sensing | | Possible | | | | | |
| | Remote ON/OFF Control | | - | | | | | |
| | Parallel Operation | | - | | | | | |
| | Series Operation | | Possible | | | | | |
| Environment | Line DIP | | Built to meet SEMI-F47 (200VAC Line only) | | | | | |
| | Operating Temperature (*11) | °C | -10 to +70 (-10 to +50: 100%, +60: 60%, +70: 20%) | | | | | |
| | Storage Temperature | °C | -30 to +85 | | | | | |
| | Operating Humidity | %RH | 30 - 90 (No dewdrop) | | | | | |
| | Storage Humidity | %RH | 10 - 95 (No dewdrop) | | | | | |
| | Vibration | | At no operating, 10 - 55Hz (sweep for 1min) 19.6m/s² constant, X, Y, Z 1hour each. | | | | | |
| Isolation | Shock (In package) | | Less than 196.1m/s² | | | | | |
| | Cooling | | Convection cooling | | | | | |
| | Withstand Voltage | | Input - FG : 2kVAC (20mA), Input - Output : 3kVAC (20mA) Output - FG : 500VAC (100mA) for 1min | | | | | |
| | Isolation Resistance | | More than 100MΩ at 25°C and 70%RH Output - FG : 500VDC | | | | | |
| Standards | Safety Standards (*12) | | Approved by UL60950-1, UL508 (24V model only), CSA C22.2 No.60950-1, CSA C22.2 No.14-M95 (24V model only), EN60950-1, EN50178 Built to meet DENAN | | | | | |
| | PFHC | | Built to meet IEC61000-3-2 | | | | | |
| | EMI | | Built to meet EN55011/EN55022-B, FCC-B, VCCI-B | | | | | |
| Mechanical | Immunity | | Built to meet IEC61000-4-2(Level 2,3), -3(Level 3), -4(Level 3), -5(Level 3,4), -6(Level 3), -8(Level 4), -11 | | | | | |
| | Weight (typ) | g | 450 | | | | | |
| | Size (W x H x D) | mm | 28 x 82 x 160 (Refer to outline drawing) | | | | | |

(*1) At 100/200VAC, Ta=25°C and maximum output power.

(*2) For cases where conformance to various safety specs (UL, CSA, EN) are required, to be described as 100 - 240VAC (50/60Hz).

(*3) Not applicable for the in-rush current to noise filter for less than 0.2ms.

(*4) Measure with JEITA RC-9131A probe, bandwidth of scope : 100MHz.

(*5) 85 - 265VAC , constant load.

(*6) No load-full load, constant input voltage.

(*7) Constant current limit and hiccup with automatic recovery. Not operate at over load or dead short condition for more than 30 seconds.

(*8) OVP circuit will shutdown output, manual reset (re power on).

(*9) At 100/200VAC, nominal output voltage and maximum output current.

(*10) Measured by the each measuring method of UL, CSA, EN and DENAN (at 60Hz).

(*11) Ratings - Derating at standard mounting.

- Load (%) is percent of maximum output power or maximum output current, whichever is greater.

- As for other mountings, refer to derating curve.

(*12) As for DENAN, built to meet at 100VAC.

Recommended EMC Filter



RSEL-2002W

Please refer to "TDK-Lambda EMC Filters" catalog.

Outline Drawing

[HWS80]

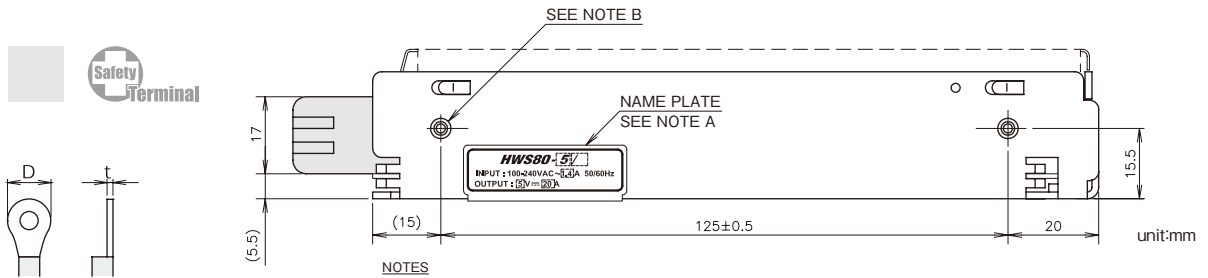
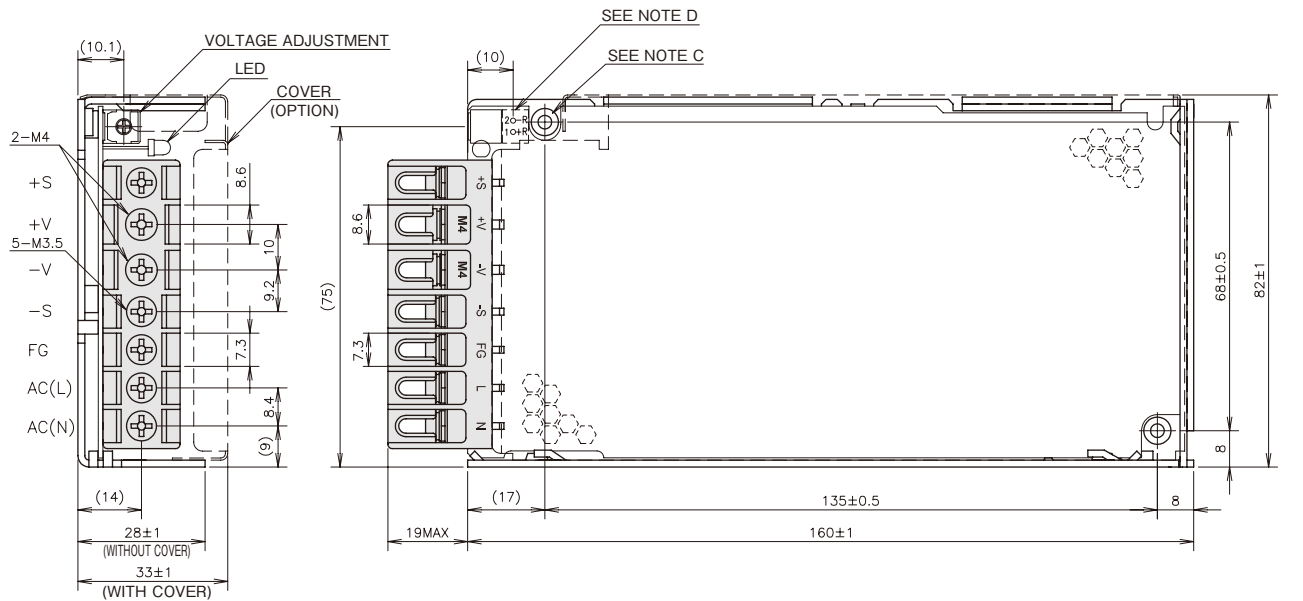

| Terminal | Recommended Solderless Terminal | | |
|----------|---------------------------------|----------------|---------------|
| | D (max) | t (max) | Qty (max) |
| +V / -V | 8.1mm | 0.8mm 1.0mm | 2 pcs 1 pc |
| Others | 6.8mm | 0.8mm | 2 pcs |

ACCESSORIES
 * SHORT PIECE (NET 2) FOR SHORTING PURPOSE
 (+S to +V, -S to -V): MOUNTED AT TIME OF SHIPMENT.

NOTES

- A : MODEL NAME, OPTION, INPUT VOLTAGE RANGE, NOMINAL OUTPUT VOLTAGE, MAXIMUM OUTPUT CURRENT AND COUNTRY OF MANUFACTURE ARE SHOWN HERE IN ACCORDANCE WITH THE SPECIFICATIONS.
- B : M3 EMBOSSED, TAPPED AND COUNTERSUNK HOLES (2) FOR CUSTOMER CHASSIS MOUNTING. SCREWS MUST NOT PROTRUDE INTO POWER SUPPLY BY MORE THAN 6m/m.
- C : M3 TAPPED HOLES (2) FOR CUSTOMER CHASSIS MOUNTING. SCREWS MUST NOT PROTRUDE INTO POWER SUPPLY BY MORE THAN 6m/m.
- D : REMOTE ON/OFF CONTROL CONNECTOR --- OPTION B2B-XH-AM (JST) MATCHING HOUSING : XHP-2 (JST)
 MATCHING TERMINAL : BXH-001T-P0.6 (JST) OR SXH-001T-P0.6 (JST)
 HAND CRIMPING TOOL : YC-110R (JST) OR YRS-110 (JST)

OPTIONAL MODELS

| MODEL | COVER | REMOTE ON/OFF CONTROL |
|-------------|-------|-----------------------|
| HWS80-* | | |
| HWS80-*/R1 | | ○ |
| HWS80-*/RA1 | ○ | ○ |

OUTPUT DERATING

●HWS80

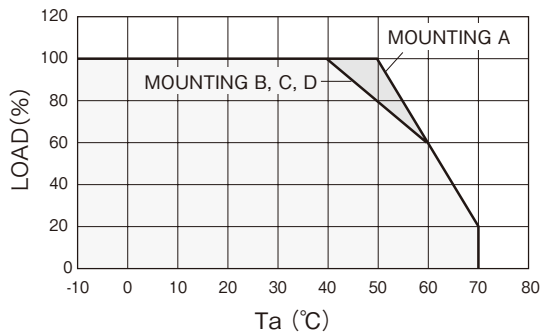

●HWS80/A

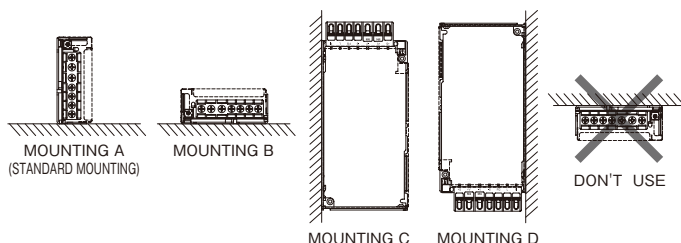
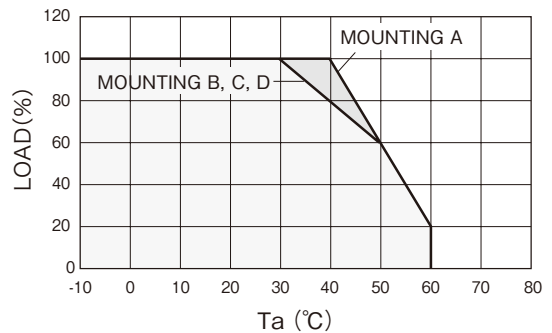

HWS100 Specifications

| ITEMS/UNITS | | MODEL | HWS100-3 | HWS100-5 | HWS100-12 | HWS100-15 | HWS100-24 | HWS100-48 |
|-----------------------|---|--|--|-------------|-------------|-------------|-------------|-------------|
| Input | Voltage Range (*2) | V | AC85 - 265 or DC120 - 370 | | | | | |
| | Frequency (*2) | Hz | 47 - 63 | | | | | |
| | Power Factor (100/200VAC)(typ) (*1) | | 0.98 / 0.90 | | 0.99 / 0.95 | | | |
| | Efficiency (100/200VAC)(typ) (*1) | % | 78 / 81 | | 83 / 86 | | 84 / 87 | |
| | Current (100/200VAC)(typ) (*1) | A | 0.9 / 0.45 | | 1.3 / 0.65 | | | |
| | Inrush Current (100/200VAC)(typ) (*3) | A | 14 / 28, Ta=25°C, cold start | | | | | |
| Leakage Current (*10) | mA | Less than 0.5. (0.2 (typ) at 100VAC / 0.4 (typ) at 230VAC) | | | | | | |
| Output | Nominal Voltage | VDC | 3.3 | 5 | 12 | 15 | 24 | 48 |
| | Maximum Current | A | 20 | | 8.5 | 7 | 4.5 | 2.1 |
| | Maximum Power | W | 66 | 100 | 102 | 105 | 108 | 100.8 |
| | Maximum Line Regulation (*5) | mV | 20 | | 48 | 60 | 96 | 192 |
| | Maximum Load Regulation (*6) | mV | 40 | | 96 | 120 | 192 | 384 |
| | Temperature Coefficient | | Less than 0.02% / °C | | | | | |
| | Maximum Ripple & Noise (0≤Ta≤70°C)(*4) | mVp-p | 120 | | 150 | | 200 | |
| | Maximum Ripple & Noise (-10≤Ta<0°C)(*4) | mVp-p | 160 | | 180 | | 240 | |
| | Hold-up Time (typ) (*9) | ms | 20 | | | | | |
| | Voltage Adjustable Range | VDC | 2.97 - 3.96 | 4.0 - 6.0 | 9.6 - 14.4 | 12.0 - 18.0 | 19.2 - 28.8 | 38.4 - 52.8 |
| Function | Over Current Protection (*7) | A | >21.0 | | >8.92 | >7.35 | >4.72 | >2.20 |
| | Over Voltage Protection (*8) | VDC | 4.13 - 4.95 | 6.25 - 7.25 | 15.0 - 17.4 | 18.8 - 21.8 | 30.0 - 34.8 | 55.2 - 64.8 |
| | Remote Sensing | | Possible | | | | | |
| | Remote ON/OFF Control | | - | | | | | |
| | Parallel Operation | | - | | | | | |
| | Series Operation | | Possible | | | | | |
| Environment | Line DIP | | Built to meet SEMI-F47 (200VAC Line only) | | | | | |
| | Operating Temperature (*11) | °C | -10 to +70 (-10 to +50: 100%, +60: 60%, +70: 20%) | | | | | |
| | Storage Temperature | °C | -30 to +85 | | | | | |
| | Operating Humidity | %RH | 30 - 90 (No dewdrop) | | | | | |
| | Storage Humidity | %RH | 10 - 95 (No dewdrop) | | | | | |
| | Vibration | | At no operating, 10 - 55Hz (sweep for 1min) 19.6m/s² constant, X, Y, Z 1hour each. | | | | | |
| Isolation | Shock (In package) | | Less than 196.1m/s² | | | | | |
| | Cooling | | Convection cooling | | | | | |
| | Withstand Voltage | | Input - FG : 2kVAC (20mA), Input - Output : 3kVAC (20mA) Output - FG : 500VAC (100mA) for 1min | | | | | |
| | Isolation Resistance | | More than 100MΩ at 25°C and 70%RH Output - FG : 500VDC | | | | | |
| Standards | Safety Standards (*12) | | Approved by UL60950-1, UL508 (24V model only), CSA C22.2 No.60950-1, CSA C22.2 No.14-M95 (24V model only), EN60950-1, EN50178 Built to meet, DENAN | | | | | |
| | PFHC | | Built to meet IEC61000-3-2 | | | | | |
| | EMI | | Built to meet EN55011/EN55022-B, FCC-B, VCCI-B | | | | | |
| Mechanical | Immunity | | Built to meet IEC61000-4-2(Level 2,3), -3(Level 3), -4(Level 3), -5(Level 3,4), -6(Level 3), -8(Level 4), -11 | | | | | |
| | Weight (typ) | g | 450 | | | | | |
| | Size (W x H x D) | mm | 28 x 82 x 160 (Refer to outline drawing) | | | | | |

(*1) At 100/200VAC, Ta=25°C and maximum output power.

(*2) For cases where conformance to various safety specs (UL, CSA, EN) are required, to be described as 100 - 240VAC (50/60Hz).

(*3) Not applicable for the in-rush current to noise filter for less than 0.2ms.

(*4) Measure with JEITA RC-9131A probe, bandwidth of scope :100MHz.

(*5) 85 - 265VAC, constant load.

(*6) No load-Full load, constant input voltage.

(*7) Constant current limit and hiccup with automatic recovery.
Not operate at over load or dead short condition for more than 30 seconds.

(*8) OVP circuit will shutdown output, manual reset (re power on).

(*9) At 100/200VAC, nominal output voltage and maximum output current.

(*10) Measured by the each measuring method of UL, CSA, EN and DENAN (at 60Hz).

(*11) Ratings - Derating at standard mounting.
- Load (%) is percent of maximum output power or maximum output current, whichever is greater.
- As for other mountings, refer to derating curve

(*12) As for DENAN, built to meet at 100VAC.

● Recommended EMC Filter

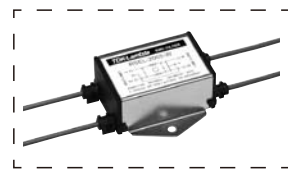

RSEL-2002W

Please refer to "TDK-Lambda EMC Filters" catalog.

Outline Drawing

[HWS100]

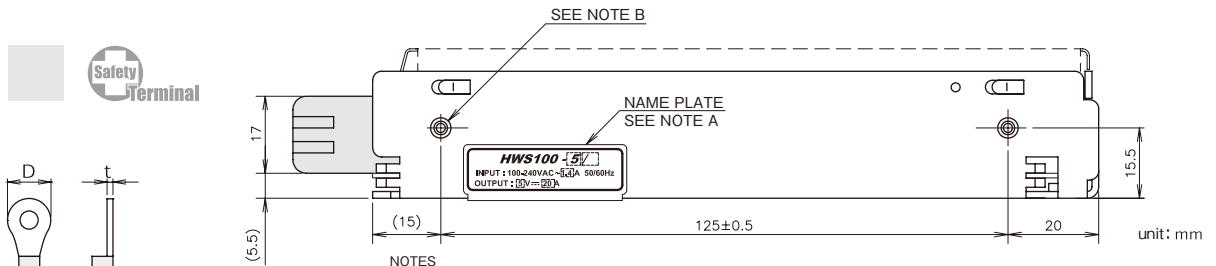
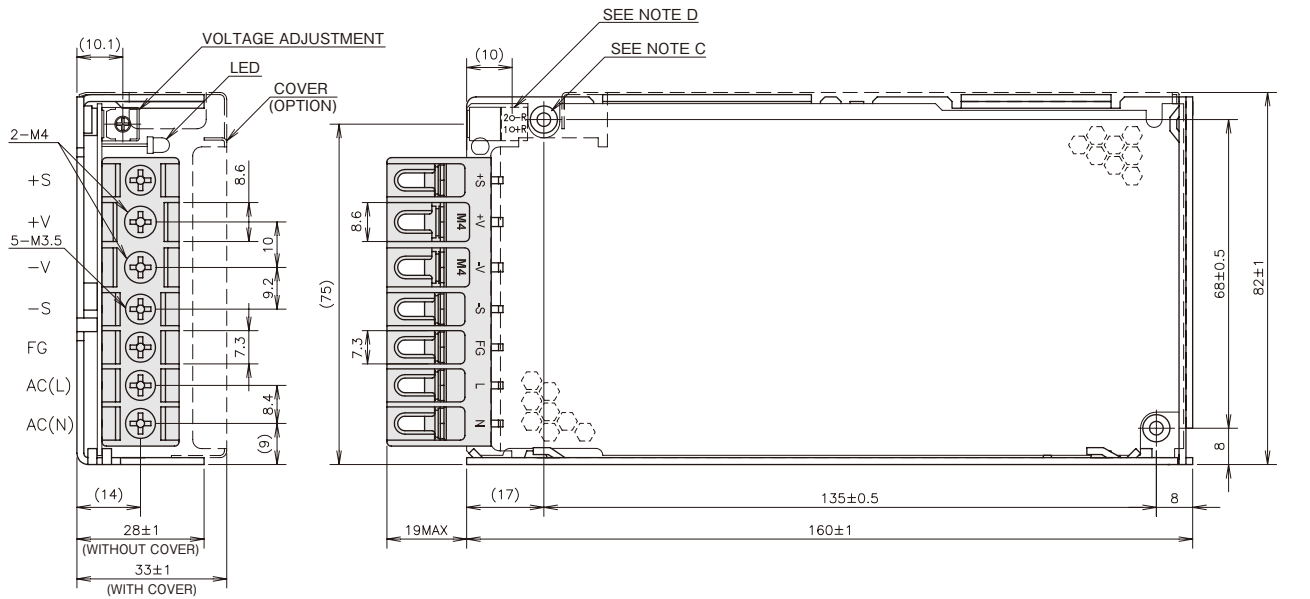

| Terminal | Recommended Solderless Terminal | | |
|----------|---------------------------------|---------|-----------|
| | D (max) | t (max) | Qty (max) |
| +V / -V | 8.1mm | 0.8mm | 2 pcs |
| Others | 6.8mm | 0.8mm | 2 pcs |

ACCESSORIES

* SHORT PIECE (NET 2) FOR SHORTING PURPOSE
 (+S to +V, -S to -V): MOUNTED AT TIME OF SHIPMENT.

- NOTES**
- A : MODEL NAME, OPTION, INPUT VOLTAGE RANGE, NOMINAL OUTPUT VOLTAGE, MAXIMUM OUTPUT CURRENT AND COUNTRY OF MANUFACTURE ARE SHOWN HERE IN ACCORDANCE WITH THE SPECIFICATIONS.
 - B : M3 EMBOSSED, TAPPED AND COUNTERSUNK HOLES (2) FOR CUSTOMER CHASSIS MOUNTING. SCREWS MUST NOT PROTRUDE INTO POWER SUPPLY BY MORE THAN 6m/m.
 - C : M3 TAPPED HOLES (2) FOR CUSTOMER CHASSIS MOUNTING. SCREWS MUST NOT PROTRUDE INTO POWER SUPPLY BY MORE THAN 6m/m.
 - D : REMOTE ON/OFF CONTROL CONNECTOR -- OPTION B2B-XH-AM (JST) MATCHING HOUSING : XHP-2 (JST) MATCHING TERMINAL : BXH-001T-P0.6 (JST) OR SXH-001T-P0.6 (JST) HAND CRIMPING TOOL : YC-110R (JST) OR YRS-110 (JST)

OPTIONAL MODELS

| MODEL | COVER | REMOTE ON/OFF CONTROL |
|-------------|-------|-----------------------|
| HWS100-* | | |
| HWS100-*/RA | | ○ |
| HWS100-*/BA | ○ | ○ |

Output Derating

HWS100

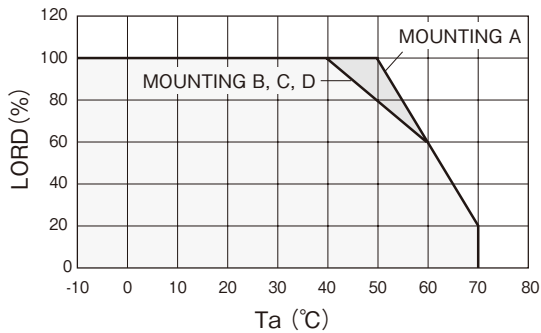

HWS100/A

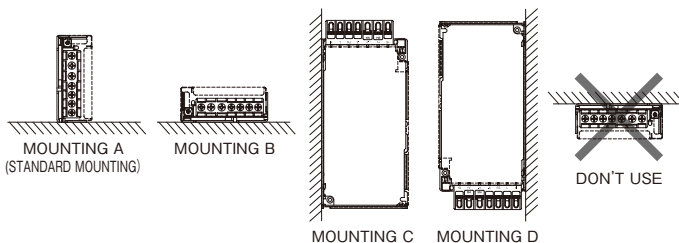
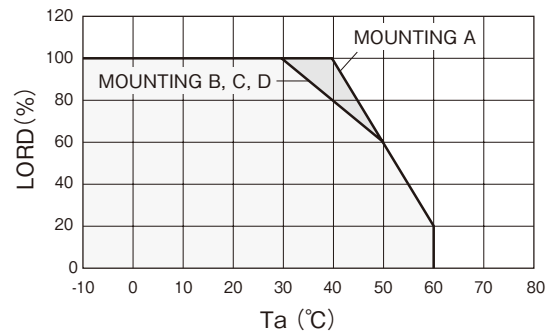

HWS150 Specifications

| ITEMS/UNITS | | MODEL | HWS150-3 | HWS150-5 | HWS150-12 | HWS150-15 | HWS150-24 | HWS150-48 |
|-----------------------|--|--|---|-------------|-------------|-------------|-------------|-------------|
| Input | Voltage Range (*2) | V | AC85 - 265 or DC120 - 370 | | | | | |
| | Frequency (*2) | Hz | 47 - 63 | | | | | |
| | Power Factor (100/200VAC)(typ) (*1) | | 0.98 / 0.90 | | 0.99 / 0.95 | | | |
| | Efficiency (100/200VAC)(typ) (*1) | % | 78 / 81 | | 83 / 86 | | 85 / 88 | |
| | Current (100/200VAC)(typ) (*1) | A | 1.3 / 0.65 | | 1.9 / 0.95 | | | |
| | Inrush Current (100/200VAC)(typ) (*3) | A | 14 / 28, Ta=25°C, cold start | | | | | |
| Leakage Current (*10) | mA | Less than 0.5. (0.2 (typ) at 100VAC / 0.4 (typ) at 230VAC) | | | | | | |
| Output | Nominal Voltage | V | 3.3 | 5 | 12 | 15 | 24 | 48 |
| | Maximum Current | A | 30 | | 13 | 10 | 6.5 | 3.3 |
| | Maximum Power | W | 99 | 150 | 156 | 150 | 156 | 158.4 |
| | Maximum Line Regulation (*5) | mV | 20 | | 48 | 60 | 96 | 192 |
| | Maximum Load Regulation (*6) | mV | 40 | | 96 | 120 | 192 | 384 |
| | Temperature Coefficient | | Less than 0.02% / °C | | | | | |
| | Maximum Ripple & Noise (0≤Ta≤70°C) (*4) | mVp-p | 120 | | 150 | | | 200 |
| | Maximum Ripple & Noise (-10≤Ta<0°C) (*4) | mVp-p | 160 | | 180 | | | 240 |
| | Hold-up Time (typ) (*9) | ms | 20 | | | | | |
| | Voltage Adjustable Range | VDC | 2.97 - 3.96 | 4.0 - 6.0 | 9.6 - 14.4 | 12.0 - 18.0 | 19.2 - 28.8 | 38.4 - 52.8 |
| Function | Over Current Protection (*7) | A | >31.5 | | >13.6 | >10.5 | >6.82 | >3.46 |
| | Over Voltage Protection (*8) | V | 4.13 - 4.95 | 6.25 - 7.25 | 15.0 - 17.4 | 18.8 - 21.8 | 30.0 - 34.8 | 55.2 - 64.8 |
| | Remote Sensing (*8) | | Possible | | | | | |
| | Remote ON/OFF Control | | - | | | | | |
| | Parallel Operation | | - | | | | | |
| | Series Operation | | Possible | | | | | |
| Environment | Line DIP | | Built to meet SEMI-F47 (200VAC Line only) | | | | | |
| | Operating Temperature (*11) | °C | -10 to +70 (-10 to +50: 100%, +60: 60%, +70: 20%) | | | | | |
| | Storage Temperature | °C | -30 to +85 | | | | | |
| | Operating Humidity | %RH | 30 - 90 (No dewdrop) | | | | | |
| | Storage Humidity | %RH | 10 - 95 (No dewdrop) | | | | | |
| | Vibration | | At no operating, 10 - 55Hz (sweep for 1min) 19.6m/s ² constant, X, Y, Z 1hour each. | | | | | |
| | Shock (In package) | | Less than 196.1m/s ² | | | | | |
| Isolation | Cooling | | Convection cooling | | | | | |
| | Withstand Voltage | | Input - FG : 2kVAC (20mA), Input - Output : 3kVAC (20mA) Output - FG : 500VAC (100mA) for 1min | | | | | |
| | Isolation Resistance | | More than 100MΩ at 25°C and 70%RH Output - FG : 500VDC | | | | | |
| Standards | Safety Standards (*12) | | Approved by UL60950-1, UL508 (24V model only), CSA C22.2 No.60950-1, CSA C22.2 No.14-M95 (24V model only), EN60950-1, EN50178 Built to meet DENAN | | | | | |
| | PFHC | | Built to meet IEC61000-3-2 | | | | | |
| | EMI | | Built to meet EN55011/EN55022-B, FCC-B, VCCI-B | | | | | |
| | Immunity | | Built to meet IEC61000-4-2(Level 2,3), -3(Level 3), -4(Level 3), -5(Level 3,4), -6(Level 3), -8(Level 4), -11 | | | | | |
| Mechanical | Weight (typ) | g | 500 | | | | | |
| | Size (W x H x D) | mm | 37 x 82 x 160 (Refer to outline drawing) | | | | | |

- (*1) At 100/200VAC, Ta=25°C and maximum output power.
- (*2) For cases where conformance to various safety specs (UL, CSA, EN) are required, to be described as 100 - 240VAC (50/60Hz).
- (*3) Not applicable for the in-rush current to noise filter for less than 0.2ms.
- (*4) Measure with JEITA RC-9131A probe, bandwidth of scope : 100MHz.
- (*5) 85 - 265VAC, constant load.
- (*6) No load-full load, constant input voltage.
- (*7) Constant current limit and hiccup with automatic recovery.
Not operate at over load or dead short condition for more than 30 seconds.
- (*8) OVP circuit will shutdown output, manual reset (re power on).
- (*9) At 100/200VAC, nominal output voltage and maximum output current.
- (*10) Measured by the each measuring method of UL, CSA, EN and DENAN (at 60Hz).
- (*11) Ratings - Derating at standard mounting.
- Load (%) is percent of maximum output power or maximum output current, whichever is greater.
- As for other mountings, refer to derating curve.
- (*12) As for DENAN, built to meet at 100VAC.

● Recommended EMC Filter

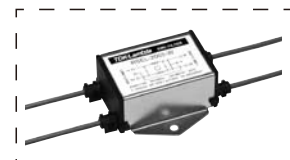

RSEL-2003W
Please refer to "TDK-Lambda EMC Filters" catalog.

Outline Drawing

[HWS150]

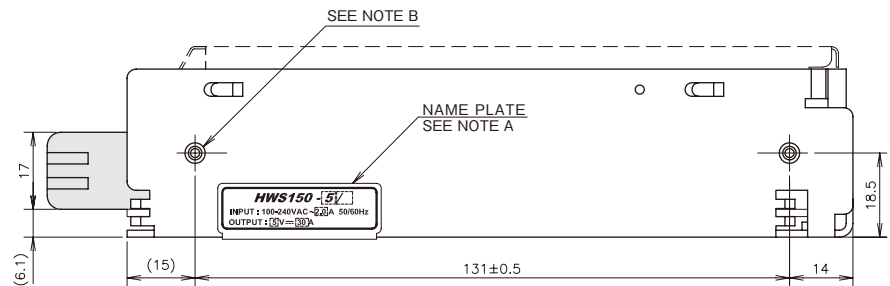
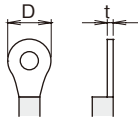
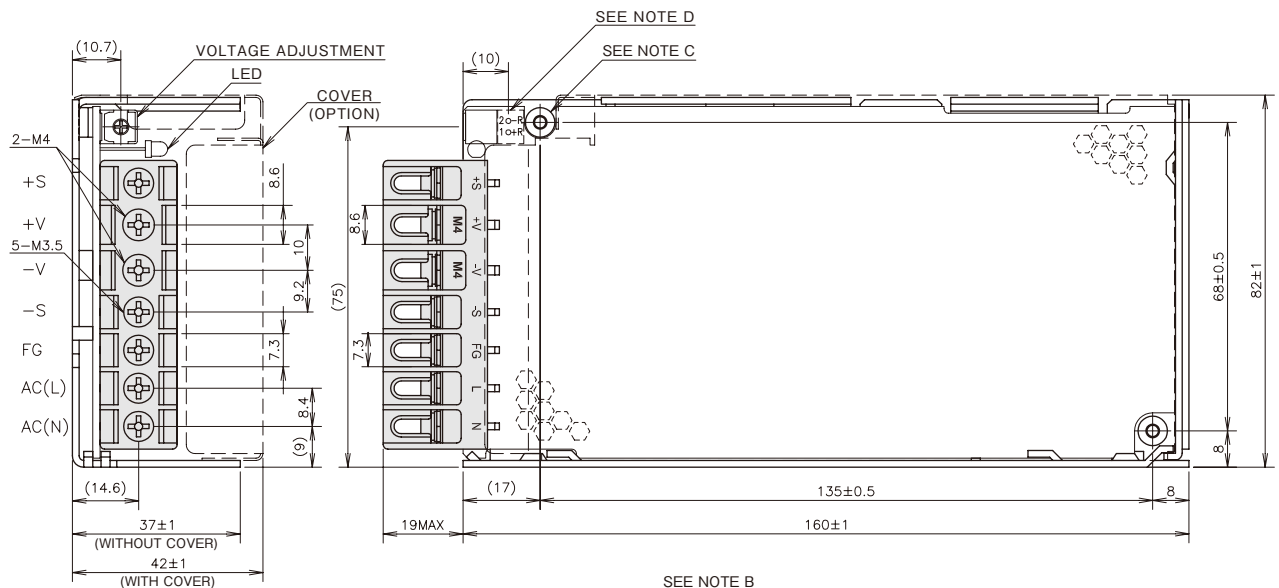

NOTES

- A: MODEL NAME, OPTION, INPUT VOLTAGE RANGE, NOMINAL OUTPUT VOLTAGE, MAXIMUM OUTPUT CURRENT AND COUNTRY OF MANUFACTURE ARE SHOWN HERE IN ACCORDANCE WITH THE SPECIFICATIONS.
- B: M3 EMBOSSED, TAPPED AND COUNTERSUNK HOLES(2) FOR CUSTOMER CHASSIS MOUNTING. SCREWS MUST NOT PROTRUDE INTO POWER SUPPLY BY MORE THAN 6m/m.
- C: M3 TAPPED HOLES (2) FOR CUSTOMER CHASSIS MOUNTING. SCREWS MUST NOT PROTRUDE INTO POWER SUPPLY BY MORE THAN 6m/m.
- D: REMOTE ON/OFF CONTROL CONNECTOR --- OPTION B2B-XH-AM (JST)
 MATCHING HOUSING : XHP-2 (JST)
 MATCHING TERMINAL : BXH-001T-P0.6 (JST) OR SXH-001T-P0.6 (JST)
 HAND CRIMPING TOOL : YC-110R (JST) OR YRS-110 (JST)

OPTIONAL MODELS

unit: mm

| Terminal | Recommended Solderless Terminal | | |
|----------|---------------------------------|---------|-----------|
| | D (max) | t (max) | Qty (max) |
| +V / -V | 8.1mm | 0.8mm | 2 pcs |
| | | 1.0mm | 1 pc |
| Others | 6.8mm | 0.8mm | 2 pcs |

ACCESSORIES

* SHORT PIECE (NET 2) FOR SHORTING PURPOSE
 (+S to +V, -S to -V): MOUNTED AT TIME OF SHIPMENT.

| MODEL | COVER | REMOTE ON/OFF CONTROL |
|-------------|-------|-----------------------|
| HWS150-* | | |
| HWS150-*/B1 | | ○ |
| HWS150-*/PA | ○ | ○ |

Output Derating

HWS150

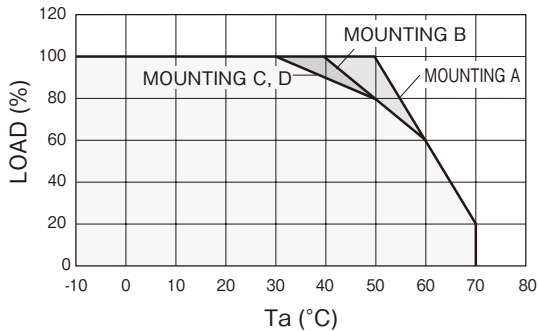

HWS150/A

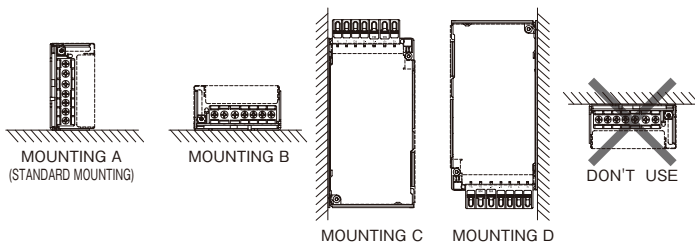
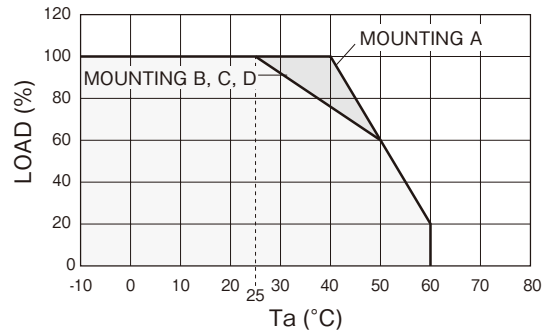

HWS300 Specifications

| ITEMS/UNITS | | MODEL | HWS300-3 | HWS300-5 | HWS300-12 | HWS300-15 | HWS300-24 | HWS300-48 | |
|-------------|--|----------------------|--|---|-------------|-------------|-------------|-------------|--|
| Input | Voltage Range (*2) | V | AC85 - 265 or DC120 - 330 | | | | | | |
| | Frequency (*2) | Hz | 47 - 63 | | | | | | |
| | Power Factor (100/200VAC)(typ) (*1) | | 0.99 / 0.95 | | | | | | |
| | Efficiency (100/200VAC)(typ) (*1) | % | 74 / 77 | 79 / 82 | 80 / 83 | | 82 / 85 | | |
| | Current (100/200VAC)(typ) (*1) | A | 2.7 / 1.4 | 3.8 / 1.9 | 4.1 / 2.1 | | | | |
| | Inrush Current (100/200VAC)(typ) (*3) | A | 20 / 40 | | | | | | |
| | Leakage Current (*10) | mA | Less than 0.75. (0.2 (typ) at 100VAC / 0.44 (typ) at 230VAC) | | | | | | |
| Output | Nominal Voltage | VDC | 3.3 | 5 | 12 | 15 | 24 | 48 | |
| | Maximum Current (*13) | A | 60 | | 27 | 22 | 14 (16.5) | | |
| | Maximum Power | W | 198 | 300 | 324 | 330 | 336 | | |
| | Maximum Line Regulation (*5) | mV | 20 | | 48 | 60 | 96 | 192 | |
| | Maximum Load Regulation (*6) | mV | 30 | | 72 | 90 | 144 | 288 | |
| | Temperature Coefficient | | Less than 0.02% / °C | | | | | | |
| | Maximum Ripple & Noise (0≤Ta≤70°C) (*4) | mVp-p | 120 | | 150 | | 350 | | |
| | Maximum Ripple & Noise (-10≤Ta<0°C) (*4) | mVp-p | 180 | | 200 | | 400 | | |
| | Hold-up Time (typ) (*9) | ms | 20 | | | | | | |
| | Voltage Adjustable Range | VDC | 2.64 - 3.96 | 4.0 - 6.0 | 9.6 - 14.4 | 12.0 - 18.0 | 19.2 - 28.8 | 38.4 - 52.8 | |
| Function | Over Current Protection (*7) | A | >63 | | > 28.4 | >23.1 | >16.7 | >7.4 | |
| | Over Voltage Protection (*8) | V | 4.13 - 4.95 | 6.25 - 7.25 | 15.0 - 17.4 | 18.8 - 21.8 | 30.0 - 34.8 | 55.2 - 64.8 | |
| | Remote Sensing | | Possible | | | | | | |
| | Remote ON/OFF Control | | Possible | | | | | | |
| | Parallel Operation | | Possible | | | | | | |
| | Series Operation | | Possible | | | | | | |
| | Monitoring Signal | | PF (Open collector output) | | | | | | |
| | Line DIP | | Designed to meet SEMI-F47 (200VAC Line only) | | | | | | |
| | Operating Temperature (*11) | °C | -10 to +70 (-10 to +50: 100%, +70: 50%) | | | | | | |
| | Storage Temperature | °C | -30 to +85 | | | | | | |
| Environment | Operating Humidity | %RH | 10 - 90 (No dewdrop) | | | | | | |
| | Storage Humidity | %RH | 10 - 95 (No dewdrop) | | | | | | |
| | Vibration | | At no operating, 10 - 55Hz (sweep for 1min) 19.6m/s ² constant, X, Y, Z 1hour each. | | | | | | |
| | Shock (In package) | | Less than 196.1m/s ² | | | | | | |
| | Cooling | | Forced air by blower fan | | | | | | |
| | Isolation | Withstand Voltage | | Input - FG : 2.5kVAC (20mA), Input - Output : 3kVAC (20mA) Output - FG: 500VAC (100mA), Output-CNT: 100VAC(100mA) for 1min | | | | | |
| | | Isolation Resistance | | More than 100MΩ Output - FG : 500VDC More than 10MΩ Output -CNT : 100VDC at 25°C and 70%RH | | | | | |
| Standards | Safety Standards (*12) | | Approved by UL60950-1, UL508 (24V model only), CSA C22.2 No.60950-1, CSA C22.2 No.14-M95 (24V model only), EN60950-1, EN50178 Designed to meet DENAN | | | | | | |
| | PFHC | | Designed to meet IEC61000-3-2 | | | | | | |
| | EMI | | Designed to meet EN55011/EN55022-B, FCC-B, VCCI-B | | | | | | |
| | Immunity | | Designed to meet IEC61000-4-2(Level 2,3), -3(Level 3), -4(Level3), -5(Level 3,4), -6(Level 3), -8(Level 4), -11 | | | | | | |
| Mechanical | Weight (typ) | g | 1000 | | | | | | |
| | Size (W x H x D) | mm | 61 x 82 x 165 (Refer to outline drawing) | | | | | | |

(*1) At 100/200VAC, Ta=25°C and maximum output power.

(*2) For cases where conformance to various safety specs (UL, CSA, EN) are required, to be described as 100-240VAC (50/60Hz).

(*3) Not applicable for the inrush current to noise filter for less than 0.2ms.

(*4) Measure with JEITA RC-9131A probe, bandwidth of scope :100MHz.

(*5) 85 - 265VAC, constant load.

(*6) No load-full load, constant input voltage.

(*7) 3.3, 5V model: Constant current limit and hiccup with automatic recovery.

12 - 48V model: Constant current limit with automatic recovery.

Avoid to operate at over load or short circuit condition for more than 30 seconds.

(*8) OVP circuit will shut the output down, manual reset (CNT reset or Re power on).

(*9) At 100/200VAC, nominal output voltage and maximum output current.

(*10) Measured by the each measuring method of UL, CSA, EN and DENAN (at 60Hz), Ta=25°C.

(*11) Ratings - Derating at standard mounting. Refer to output derating curve.

- Load (%) is percent of maximum output power or maximum output current, whichever is greater.

(*12) As for DENAN, designed to meet at 100VAC.

(*13) () : Peak output current at 200VAC. Operating time at peak output is less than 10 sec, duty is less than 35%.

● Recommended EMC Filter



RSEN-2006

Please refer to "TDK-Lambda EMC Filters" catalog.

Outline Drawing

[HWS300]

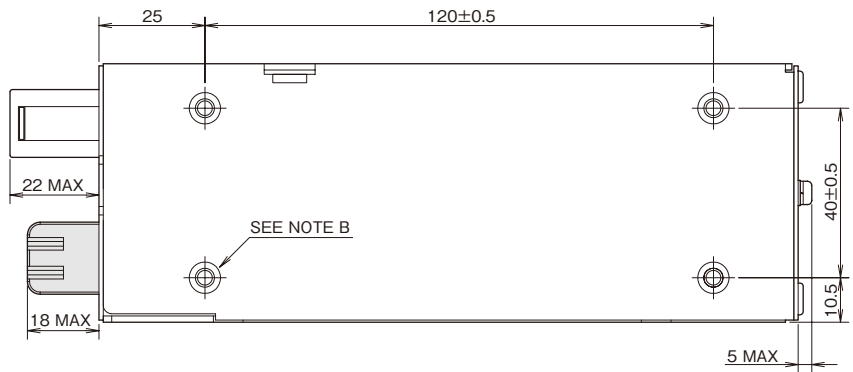
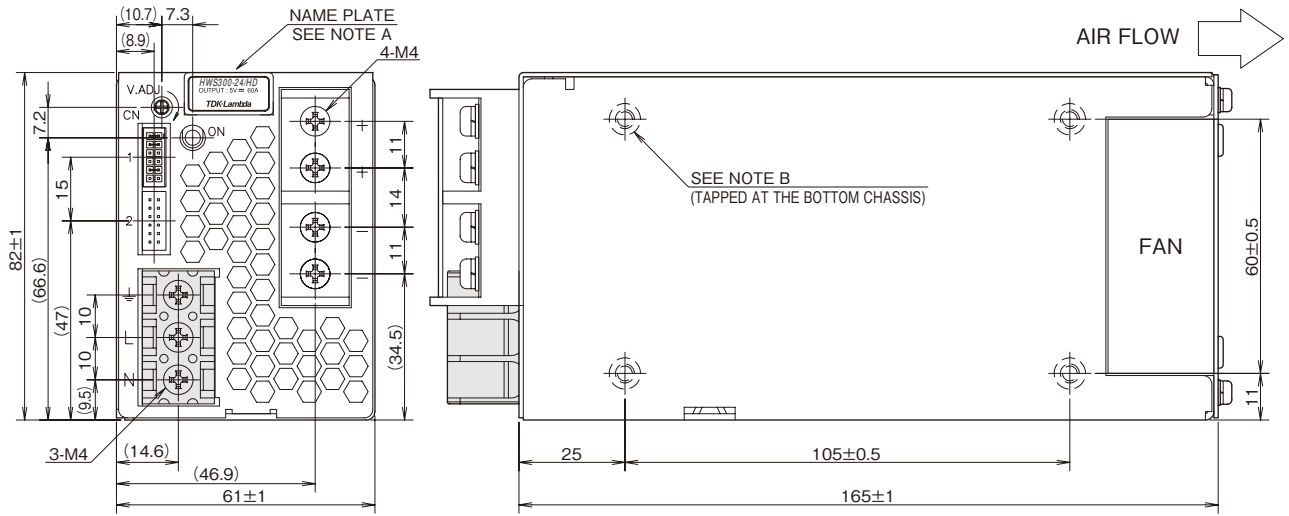

[unit: mm]

== SIGNAL CONNECTOR USED ==

| PART DESCRIPTION | PART NAME | MANUFACT |
|------------------|------------|----------|
| PIN HEADER | S12B-PHDSS | JST |

== MATCHING HOUSINGS, PINS & TOOL ==

| PART DESCRIPTION | PART NAME | MANUFACT |
|--------------------|--|----------|
| SOCKET HOUSING | PHDR-12VS | JST |
| TERMINAL PINS | SPHD-002T-P0.5 (AWG28 - 24) SPHD-001T-P0.5 (AWG26 - 22) | JST |
| HAND CRIMPING TOOL | YRS-620 (SPHD-002T-P0.5) YC-610R (SPHD-001T-P0.5) | JST |

== NOTES ==

- A : MODEL NAME, NOMINAL OUTPUT VOLTAGE AND MAXIMUM OUTPUT CURRENT ARE SHOWN IN THE NAME PLATE IN ACCORDANCE WITH THE SPECIFICATIONS.
- B : M4 TAPPED HOLES (8) FOR CUSTOMER CHASSIS MOUNTING. (SCREW PENETRATION DEPTH 6mm MAX.)

== OPTIONAL MODELS ==

| MODEL | COATING |
|-------------|---------|
| HWS300-* | — |
| HWS300-*/CD | ○ |
| HWS300-*/HD | ○ |

== ACCESSORIES ==

- *COVER FOR BARRIER TERMINAL STRIP -----1 (ATTACHED ON TERMINAL AT SHIPMENT)
- *SHORT PIECE -----1 SHORTING +Vm→S, -Vm→S. CNT→TOG (ATTACHED ON CN1 AT SHIPMENT)

Output Derating

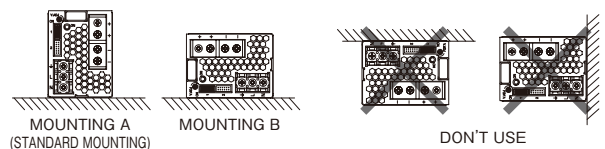
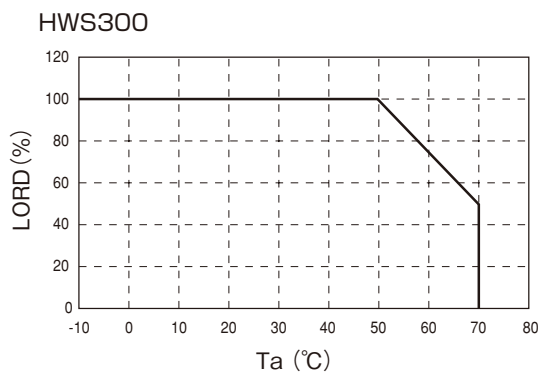

HWS600 Specifications

| ITEMS/UNITS | | MODEL | HWS600-3 | HWS600-5 | HWS600-12 | HWS600-15 | HWS600-24 | HWS600-48 | |
|-------------|---|----------------------|---|--|-------------|-------------|-------------|-------------|--|
| Input | Voltage Range (*2) | V | AC85 - 265 or DC120 - 330 | | | | | | |
| | Frequency (*2) | Hz | 47 - 63 | | | | | | |
| | Power Factor (100/200VAC)(typ) (*1) | | 0.99 / 0.95 | | | | | | |
| | Efficiency (100/200VAC)(typ) (*1) | % | 75 / 78 | 80 / 83 | | 81 / 84 | 82 / 85 | 83 / 86 | |
| | Current (100/200VAC)(typ) (*1) | A | 5.4 / 2.6 | 7.5 / 3.6 | | 8.1 / 3.9 | | | |
| | Inrush Current (100/200VAC)(typ) (*3) | A | 20 / 40 | | | | | | |
| | Leakage Current (*10) | mA | Less than 0.75. (0.2 (typ) at 100VAC / 0.44 (typ) at 230VAC) | | | | | | |
| Output | Nominal Voltage | VDC | 3.3 | 5 | 12 | 15 | 24 | 48 | |
| | Maximum Current (*13) | A | 120 | | 53 | 43 | 27(31) | 13 | |
| | Maximum Power | W | 396 | 600 | 636 | 645 | 648 | 624 | |
| | Maximum Line Regulation (*5) | mV | 20 | | 48 | 60 | 96 | 192 | |
| | Maximum Load Regulation (*6) | mV | 30 | | 72 | 90 | 144 | 288 | |
| | Temperature Coefficient | | Less than 0.02% / °C | | | | | | |
| | Maximum Ripple & Noise (0≤Ta≤70°C) (*4) | mVp-p | 120 | | 150 | | 350 | | |
| | Maximum Ripple & Noise (-10≤Ta≤ 0°C) (*4) | mVp-p | 180 | | 200 | | 400 | | |
| | Hold-up Time (typ) (*9) | ms | 20ms | | | | | | |
| | Voltage Adjustable Range | VDC | 2.64 - 3.96 | 4.0 - 6.0 | 9.6 - 14.4 | 12.0 - 18.0 | 19.2 - 28.8 | 38.4 - 52.8 | |
| Function | Over Current Protection (*7) | A | >126 | | >55.7 | >45.2 | >31.4 | >13.7 | |
| | Over Voltage Protection (*8) | VDC | 4.13 - 4.95 | 6.25 - 7.25 | 15.0 - 17.4 | 18.8 - 21.8 | 30.0 - 34.8 | 55.2 - 64.8 | |
| | Remote Sensing | | Possible | | | | | | |
| | Remote ON/OFF Control | | Possible | | | | | | |
| | Parallel Operation | | Possible | | | | | | |
| | Series Operation | | Possible | | | | | | |
| | Monitoring Signal | | PF (Open collector output) | | | | | | |
| | Line DIP | | Designed to meet SEMI-F47 (200VAC Line only) | | | | | | |
| | Operating Temperature (*11) | °C | -10 to +70 (-10 to +50: 100%, +70: 50%) | | | | | | |
| | Storage Temperature | °C | -30 to +85 | | | | | | |
| Environment | Operating Humidity | %RH | 10 - 90 (No dewdrop) | | | | | | |
| | Storage Humidity | %RH | 10 - 95 (No dewdrop) | | | | | | |
| | Vibration | | At no operating, 10 - 55Hz (sweep for 1min) 19.6m/s ² constant, X, Y, Z 1hour each. | | | | | | |
| | Shock (In package) | | Less than 196.1m/s ² | | | | | | |
| | Cooling | | Forced air by blower fan | | | | | | |
| | Isolation | Withstand Voltage | | Input - FG : 2.5kVAC (20mA), Input - Output : 3kVAC (20mA) Output - FG : 500VAC (100mA), Output - CNT : 100VAC (100mA) for 1min | | | | | |
| | | Isolation Resistance | | More than 100MΩ Output - FG : 500VDC More than 10MΩ Output - CNT: 100VDC at 25°C and 70%RH | | | | | |
| Standards | Safety Standards (*12) | | Approved by UL60950-1, UL508 (24V model only), CSA C22.2 No.60950-1, CSA C22.2 No.14-M95 (24V model only), EN60950-1, EN50178, Designed to meet DENAN | | | | | | |
| | PFHC | | Designed to meet IEC61000-3-2 | | | | | | |
| | EMI | | Designed to meet EN55011/EN55022-B, FCC-B, VCCI-B | | | | | | |
| | Immunity | | Designed to meet IEC61000-4-2(Level 2,3), -3(Level 3), -4(Level 3), -5(Level 3,4), -6(Level 3), -8(Level 4), -11 | | | | | | |
| Mechanical | Weight (typ) | g | 1600 | | | | | | |
| | Size (W x H x D) | mm | 100 x 82 x 165 (Refer to outline drawing) | | | | | | |

(*1) At 100/200VAC, Ta=25°C and maximum output power.

(*2) For cases where conformance to various safety specs (UL, CSA, EN) are required, to be described as 100 - 240VAC (50/60Hz).

(*3) Not applicable for the inrush current to noise filter for less than 0.2ms. Inrush current is 30A (typ) when PFHC start-up.

(*4) Measure with JEITA RC-9131A probe, bandwidth of scope :100MHz.

(*5) 85 - 265VAC, constant load.

(*6) No load - full load, constant input voltage.

(*7) 3V and 5V model: Constant current limit and hiccup with automatic recovery.
12 - 48V model: Constant current limit with automatic recovery.
Avoid to operate at over load or short circuit condition for more than 30 seconds.

(*8) OVP circuit will shut the output down, manual reset (CNT reset or re-power on).

(*9) At 100/200VAC, nominal output voltage and maximum output current.

(*10) Measured by the each measuring method of UL, CSA, EN and DENAN (at 60Hz), Ta=25°C.

(*11) Ratings - Derating at standard mounting. Refer to output derating curve.
- Load (%) is percent of maximum output power or maximum output current, whichever is greater.

(*12) As for DENAN, designed to meet at 100VAC.

(*13) () : Peak output current at 200VAC. Operating time at peak output is less than 10 sec, duty is less than 35%.

● Recommended EMC Filter



RSEN-2016

Please refer to "TDK-Lambda EMC Filters" catalog.

Outline Drawing

[HWS600]

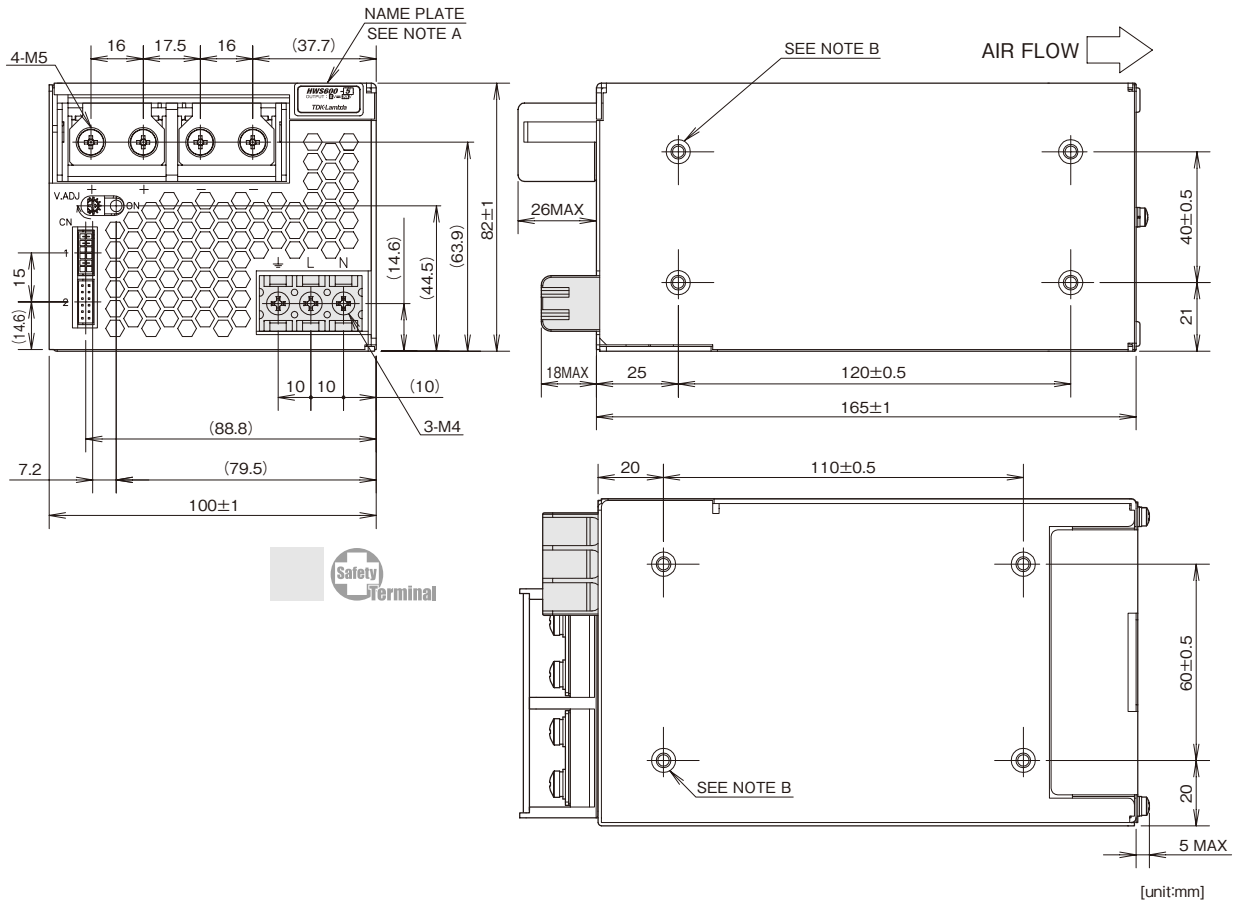

== SIGNAL CONNECTOR USED ==

| PART DESCRIPTION | PART NAME | MANUFACT |
|------------------|------------|----------|
| PIN HEADER | S12B-PHDSS | JST |

== MATCHING HOUSINGS, PINS & TOOL ==

| PART DESCRIPTION | PART NAME | MANUFACT |
|--------------------|--|----------|
| SOCKET HOUSING | PHDR-12VS | JST |
| TERMINAL PINS | SPHD-002T-P0.5 (AWG28 - 24) SPHD-001T-P0.5 (AWG26 - 22) | JST |
| HAND CRIMPING TOOL | YRS-620 (SPHD-002T-P0.5) YC-610R (SPHD-001T-P0.5) | JST |

== NOTES ==

A : MODEL NAME, NOMINAL OUTPUT VOLTAGE AND MAXIMUM OUTPUT CURRENT ARE SHOWN IN THE NAME PLATE IN ACCORDANCE WITH THE SPECIFICATIONS.
 B : M4 TAPPED HOLES (8) FOR CUSTOMER CHASSIS MOUNTING. (SCREW PENETRATION DEPTH 6mm MAX.)

== ACCESSORIES ==

*COVER FOR BARRIER TERMINAL STRIP ----1 (ATTACHED ON TERMINAL AT SHIPMENT)
 *SHORT PIECE ----1 (SHORTING +Vm→+S, -Vm→-S, CNT→TOG (ATTACHED ON CN1 AT SHIPMENT))

OPTIONAL MODELS

| MODEL | COATING |
|-------------|---------|
| HWS600-* | - |
| HWS600-*/CO | ○ |
| HWS600-*/HD | ○ |

Output Derating

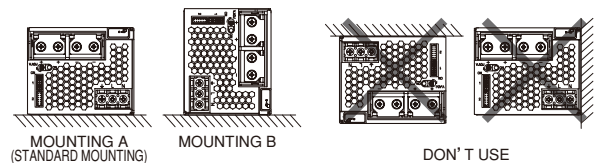
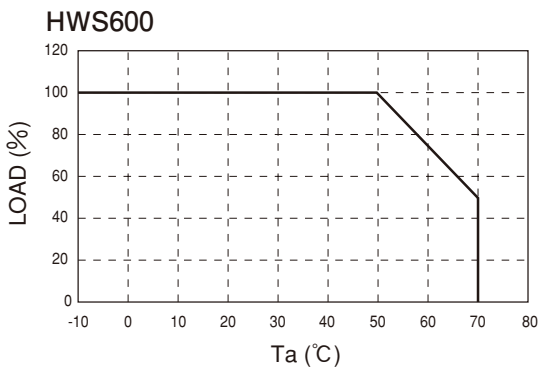

HWS1000 Specifications

| ITEMS/UNITS | | MODEL | HWS1000 -3 | HWS1000 -5 | HWS1000 -6 | HWS1000 -7 | HWS1000 -12 | HWS1000 -15 | HWS1000 -24 | HWS1000 -36 | HWS1000 -48 | HWS1000 -60 |
|------------------------------|---------------------------------------|-----------------------------|--|--|---------------|---------------|-----------------------------|----------------|----------------|----------------|----------------|----------------|
| Input | Voltage Range (*2) | V | AC85 - 265 or DC120 - 330 | | | | | | | | | |
| | Frequency (*2) | Hz | 47 - 63 | | | | | | | | | |
| | Power Factor (100/200VAC)(typ) (*1) | | 0.98 / 0.95 | | | | | | | | | |
| | Efficiency (100/200VAC)(typ) (*1) | % | 71 / 73 | 76 / 78 | 79 / 81 | 80 / 82 | 83 / 85 | 85 / 87 | 85 / 88 | 86 / 88 | 85 / 88 | |
| | Current (100/200VAC)(typ) (*1) | A | 9.6 / 5.0 13.5 / 7.0 | | | | | | | | | |
| | Inrush Current (100/200VAC)(typ) (*3) | A | 20 / 40 | | | | | | | | | |
| Output | Leakage Current (100/240VAC) (*10) | mA | 1.2 max | | | | | | | | | |
| | Nominal Voltage | VDC | 3.3 | 5 | 6 | 7.5 | 12 | 15 | 24 | 36 | 48 | 60 |
| | Maximum Current | A | 200 | | 167 | 134 | 88 | 70 | 44 | 29.3 | 22 | 17.6 |
| | Maximum Peak Current (*13) | A | - | | 160 | 100 | 80 | 50 | 33.3 | 25 | 20 | |
| | Maximum Power | W | 660 | 1000 | 1002 | 1005 | 1056 | 1050 | 1056 | | | |
| | Maximum Peak Power (*13) | W | - | | 1200 | | | | | | | |
| | Maximum Line Regulation (*5) | mV | 20 | | 36 | 48 | 60 | 96 | 144 | 192 | 240 | |
| | Maximum Load Regulation (*6) | mV | 40 | | 60 | 100 | 120 | 150 | | 300 | 360 | |
| | Temperature Coefficient | | Less than 0.02%/°C | | | | | | | | | |
| | Maximum Ripple & Noise (0~+70°C) (*4) | mVp-p | 120 | | 150 | | | 200 | | | 400 | |
| | Maximum Ripple & Noise (-10~0°C) (*4) | mVp-p | 160 | | 180 | | | 240 | | | 500 600 | |
| | Hold-up Time (typ) (*9) | ms | 20 | | | | | | | | | |
| | Function | Voltage Adjustable Range | VDC | 2.64 - 3.96 | 4.0 - 6.0 | 4.8 - 7.2 | 6.0 - 9.0 | 9.6 - 14.4 | 12.0 - 18.0 | 19.2 - 28.8 | 28.8 - 43.2 | 38.4 - 52.8 |
| Over Current Protection (*7) | | | >105% (Maximum output current) | | | | >105% (Peak output current) | | | | | |
| Over Voltage Protection (*8) | | VDC | 4.13 - 4.62 | 6.25 - 7.0 | 7.5 - 8.4 | 9.38 - 10.5 | 15.0 - 17.4 | 18.8 - 21.8 | 30.0 - 34.8 | 45.0 - 49.7 | 55.2 - 60.0 | 69.0 - 75.0 |
| Remote Sensing | | | Possible | | | | | | | | | |
| Remote ON/OFF Control | | | Possible | | | | | | | | | |
| Parallel Operation | | | Possible | | | | | | | | | |
| Series Operation | | | Possible | | | | | | | | | |
| Monitoring Signal | | | PF (Open collector output) | | | | | | | | | |
| Line DIP | | | Built to meet SEMI-F47 (200VAC line only) | | | | | | | | | |
| Environment | | Operating Temperature (*11) | °C | -10 to +71 (-10 to +50 (5V : -10 to +40): 100%, +71: 50%), start up -20 to 71 | | | | | | | | |
| | Storage Temperature | °C | -30 to +85 | | | | | | | | | |
| | Operating Humidity | %RH | 10 - 90 (No dewdrop) | | | | | | | | | |
| | Storage Humidity | %RH | 10 - 95 (No dewdrop) | | | | | | | | | |
| | Vibration | | At no operating, 10 - 55Hz (sweep for 1min.) 19.6m/s ² constant, X, Y, Z 1h each. | | | | | | | | | |
| | Shock (In package) | | Less than 196.1m/s ² | | | | | | | | | |
| | Cooling | | Forced air by blower fan | | | | | | | | | |
| Isolation | Withstand Voltage | | Input - FG : 2kVAC (20mA), Input - Output : 3kVAC (20mA) Output-FG : 500VAC (300mA) (60V model 651VAC (390mA)), Output-CNT:100VAC (100mA) for 1min. | | | | | | | | | |
| | Isolation Resistance | | More than 100Mohm Output - FG ... 500VDC More than 10Mohm Output - CNT ... 100VDC at 25°C and 70%RH | | | | | | | | | |
| Standards | Safety Standards (*12) | | Built to meet UL60950-1, CSA60950-1, EN60950-1, EN50178. Built to meet DENAN. | | | | | | | | | |
| | PFHC | | Built to meet IEC61000-3-2 | | | | | | | | | |
| | EMI | | Built to meet EN55011/EN55022-B, FCC-ClassB, VCCI-ClassB, CISPR-ClassB. | | | | | | | | | |
| Mechanical | Immunity | | Built to meet IEC61000-4-2(Level 2,3), -3(Level 3), -4(Level 3), -5(Level 3,4), -6(Level 3), -8(Level 4), -11 | | | | | | | | | |
| | Weight (typ) | g | 3200 | | | | | | | | | |
| | Size (W x H x D) | mm | 126.5 x 82 x 240 (Refer to outline drawing) | | | | | | | | | |

(*1) At Ta=25°C and maximum output power.

(*2) For cases where conformance to various safety specs (UL, CSA, EN) are required, input voltage range will be 100 - 240VAC (50/60Hz).

(*3) First in-rush current. Not applicable for the in-rush current to noise filter less than 0.2ms.

(*4) Measure with JEITA RC-9131A probe, bandwidth of scope :100MHz.
(At 22uF electric capacitor and 0.47uF film capacitor on the test fixture board.)

(*5) 85 - 265VAC, constant load.

(*6) No load-full load, constant input voltage.

(*7) Constant current limit with automatic recovery. An output will be intercepted if it continues for about 5 seconds.
Output current exceeding maximum rated output current for more than 10 seconds continuously will result to output shutdown.

(*8) OVP circuit will shut down output, manual reset (power cycle) or ON/OFF CNT signal reset.

(*9) At 100/200VAC, nominal output voltage and maximum output current.

(*10) Measured by the each measuring method of UL, CSA, EN and DENAN (at 60Hz), Ta=25°C.

(*11) Ratings - Derating at standard mounting.

- Load (%) is percent of maximum output power or maximum output current, whichever is greater.
- As for other mountings, refer to derating curve.

(*12) As for DENAN, built to meet at 100VAC.

(*13) Peak output current is less than 10 seconds, and duty 35% max.

● Recommended EMC Filter



RSEN-2020

Please refer to "TDK-Lambda EMC Filters" catalog.

Outline Drawing

[HWS1000]

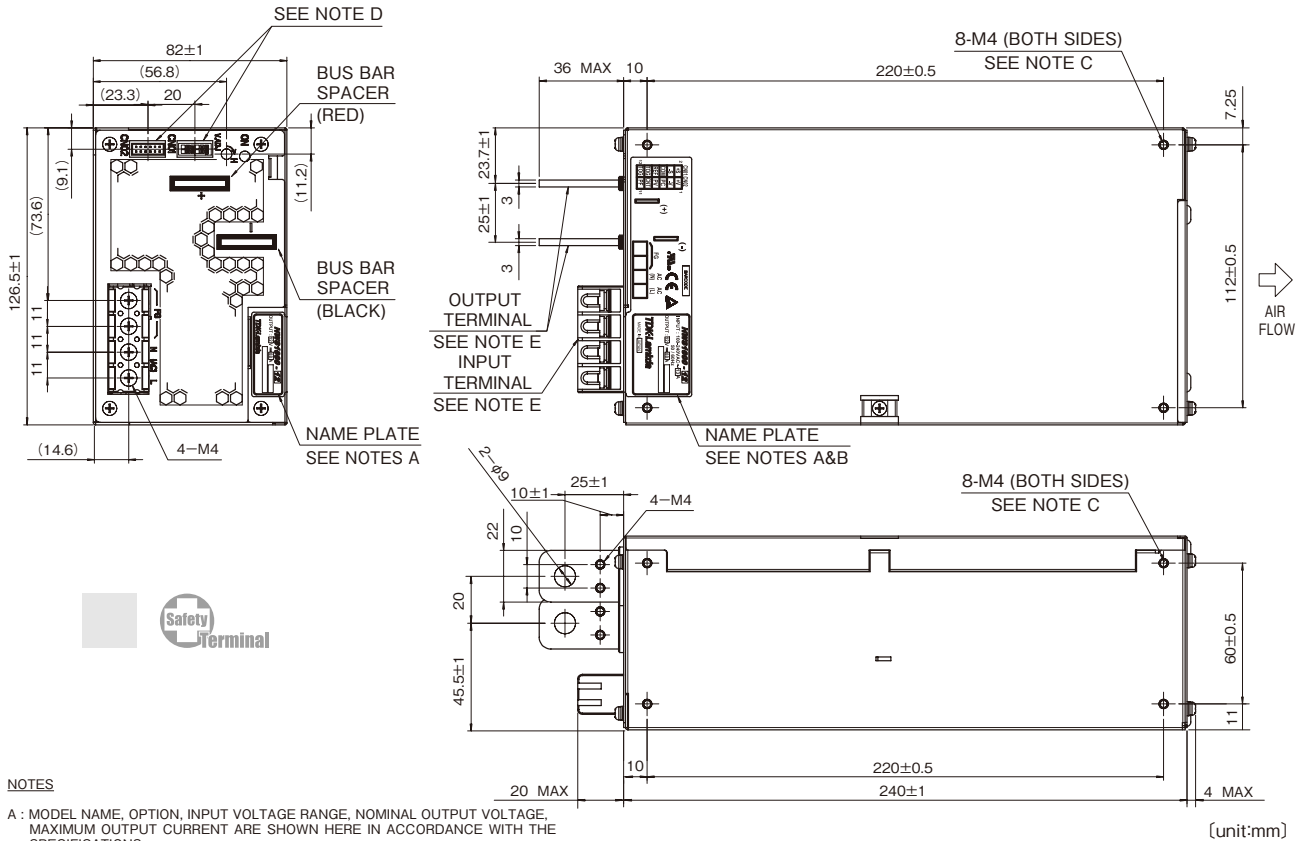

NOTES

- A : MODEL NAME, OPTION, INPUT VOLTAGE RANGE, NOMINAL OUTPUT VOLTAGE, MAXIMUM OUTPUT CURRENT ARE SHOWN HERE IN ACCORDANCE WITH THE SPECIFICATIONS.
- B : COUNTRY OF MANUFACTURE IS SHOWN HERE.
- C : M4 TAPPED HOLES (16) FOR CUSTOMER CHASSIS MOUNTING. [SCREWS MUST NOT PROTRUDE INTO POWER SUPPLY BY MORE THAN 6mm/m.] RECOMMENDED M4 SCREWS TORQUE : 1.27N·m
- D : I/O SIGNAL CONNECTOR

| | | |
|--------------------|-------------------------------|----------|
| CONNECTOR | : S12B-PHDSS (LF) (SN) | (JST) |
| MATCHING HOUSING | : PHDR-12VS | (JST) |
| MATCHING CONTACT | : SPHD-002T-P0.5 (AWG28 - 24) | (JST) OR |
| | : SPHD-001T-P0.5 (AWG26 - 22) | (JST) OR |
| | : BPHD-001T-P0.5 (AWG26 - 22) | (JST) |
| HAND CRIMPING TOOL | : YRS-620 (SPHD-002T-P0.5) | (JST) |
| | : YC-610R (SPHD-001T-P0.5) | (JST) |
| | : YC-610R (BPHD-001T-P0.5) | (JST) |
- E : RECOMMENDED TORQUE FOR THE TERMINAL PIECE.

| | |
|---------------------------------|-----------|
| INPUT TERMINAL (M4 SCREW) | : 1.27N·m |
| OUTPUT TERMINAL (M8 BOLT & NUT) | : 10.8N·m |
| OUTPUT TERMINAL (M4 SCREW) | : 1.27N·m |

ACCESSORIES

* ATTACHED CONNECTOR SHORTING +S - +V, -S - -V, PV - REF & CNT - TOG ATTACHED ON CN01 AT SHIPMENT

Output Derating

HWS1000

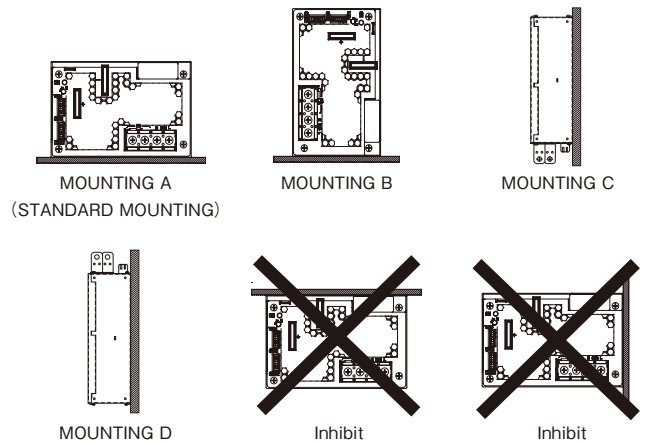
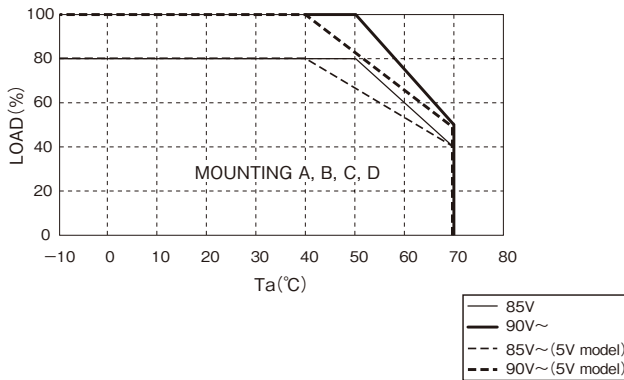

HWS1500 Specifications

| ITEMS/UNITS | | MODEL | HWS1500-12 | HWS1500-15 | HWS1500-24 | HWS1500-36 | HWS1500-48 | |
|------------------------------|---------------------------------------|------------------------------|--|---|-------------|-------------|-------------|-----|
| Input | Voltage Range (*2) | V | AC85 - 265 | | | | | |
| | Frequency (*2) | Hz | 47 - 63 | | | | | |
| | Power Factor (100/230VAC)(typ) (*1) | | 0.98 / 0.94 | | | | | |
| | Efficiency (100/200VAC)(typ) (*1) | % | 82 / 85 | 83 / 87 | 84 / 88 | | 86 / 90 | |
| | Current (100/200VAC)(typ) (*1) | A | 19.0 / 10.0 | | | | | |
| | Inrush Current (100/200VAC)(typ) (*3) | A | 20 / 40 | | | | | |
| | Leakage Current (100/240VAC) (*10) | mA | 1.5 max | | | | | |
| Output | Nominal Voltage | VDC | 12 | 15 | 24 | 36 | 48 | |
| | Maximum Current (100/200VAC) | A | 125 / 125 | 100 / 100 | 65 / 70 | 42 / 46.5 | 32 / 32 | |
| | Maximum Peak Current (*13) | A | — | | | | | |
| | Maximum Power (100/200VAC) | W | 1500 / 1500 | | 1560 / 1680 | 1512 / 1674 | 1536 / 1536 | |
| | Maximum Peak Power (*13) | W | — | | | | | |
| | Maximum Line Regulation (*5) | mV | 48 | 60 | 96 | 144 | 192 | |
| | Maximum Load Regulation (*6) | mV | 72 | 90 | 144 | 150 | 288 | |
| | Temperature Coefficient | | Less than 0.02%/°C | | | | | |
| | Maximum Ripple & Noise (0~+70°C) (*4) | mVp-p | 150 | | | 200 | | 400 |
| | Maximum Ripple & Noise (-10~0°C) (*4) | mVp-p | 200 | | | 240 | | 400 |
| | Hold-up Time (typ) (*9) | ms | 20 | | | | | |
| | Voltage Adjustable Range | VDC | 9.6 - 14.4 | 12.0 - 18.0 | 19.2 - 28.8 | 28.8 - 43.2 | 38.4 - 52.8 | |
| | Function | Over Current Protection (*7) | | >105% | | | | |
| Over Voltage Protection (*8) | | VDC | 15.0 - 17.4 | 18.7 - 21.8 | 30.0 - 34.8 | 45.0 - 49.7 | 55.2 - 64.8 | |
| Remote Sensing | | | Possible | | | | | |
| Remote ON/OFF Control | | | Possible | | | | | |
| Parallel Operation | | | Possible | | | | | |
| Series Operation | | | Possible | | | | | |
| Monitoring Signal | | | PF (Open collector output) | | | | | |
| Line DIP | | | Built to meet SEMI-F47 (200VAC Line only) | | | | | |
| Environment | | Operating Temperature (*11) | °C | -10 to +70 (-10 to +50: 100%, +60: 75%,+70: 50%), start up -20 to 70 | | | | |
| | Storage Temperature | °C | -30 to +85 | | | | | |
| | Operating Humidity | %RH | 10 - 90 (No dewdrop) | | | | | |
| | Storage Humidity | %RH | 10 - 95 (No dewdrop) | | | | | |
| | Vibration | | At no operating, 10 - 55Hz (sweep for 1min.) 19.6m/s ² constant, X, Y, Z 1h each. | | | | | |
| | Shock (In package) | | Less than 196.1m/s ² | | | | | |
| | Cooling | | Forced air by blower fan | | | | | |
| | Isolation | Withstand Voltage | | Input - FG : 2kVAC (20mA), Input - Output : 3kVAC (20mA) Output-FG : 500VAC (300mA), Output-CNT:100VAC (100mA) for 1min. | | | | |
| Isolation Resistance | | | More than 100Mohm Output - FG ... 500VDC More than 10Mohm Output - CNT ... 100VDC at 25°C and 70%RH | | | | | |
| Standards | Safety Standards (*12) | | Built to meet UL60950-1, CSA60950-1, EN60950-1, EN50178. Built to meet DENAN. | | | | | |
| | PFHC | | Built to meet IEC61000-3-2 | | | | | |
| | EMI | | Built to meet EN55011/EN55022-A, FCC-ClassA, VCCI-ClassA. | | | | | |
| | Immunity | | Built to meet IEC61000-4-2(Level 2,3), -3(Level 3), -4(Level 3), -5(Level 3,4), -6(Level 3), -8(Level 4), -11 | | | | | |
| Mechanical | Weight (typ) | g | 3800 | | | | | |
| | Size (W x H x D) | mm | 126.5 x 82 x 280 (Refer to outline drawing) | | | | | |

(*1) At Ta=25°C and maximum output power.

(*2) For cases where conformance to various safety specs (UL, CSA, EN) are required, input voltage range will be 100 - 240VAC (50/60Hz).

(*3) First in-rush current. Not applicable for the in-rush current to noise filter less than 0.2ms.

(*4) Measure with JEITA RC-9131A probe, bandwidth of scope: 100MHz. (at 22uF electric capacitor and 0.47uF film capacitor on the test fixture board.)

(*5) 85 - 265VAC, constant load.

(*6) No load-Full load, constant input voltage.

(*7) Constant current limit with automatic recovery. An output will be intercepted if it continues for about 5 seconds.

(*8) OVP circuit will shut down output, manual reset (power cycle) or ON/OFF CNT signal reset.

(*9) At 100/200VAC, nominal output voltage and maximum output current.

(*10) Measured by the each measuring method of UL, CSA, EN and DENAN (at 60Hz), Ta=25°C.

(*11) Ratings - Derating at standard mounting.

- Load (%) is percent of maximum output power or maximum output current, whichever is greater.
- As for other mountings, refer to derating curve.

(*12) As for DENAN, built to meet at 100VAC.

(*13) Peak output current is less than 10 seconds, and duty 35% max.

Recommended EMC Filter



RSEN-2030

Please refer to "TDK-Lambda EMC Filters" catalog.

Outline Drawing

[HWS1500]

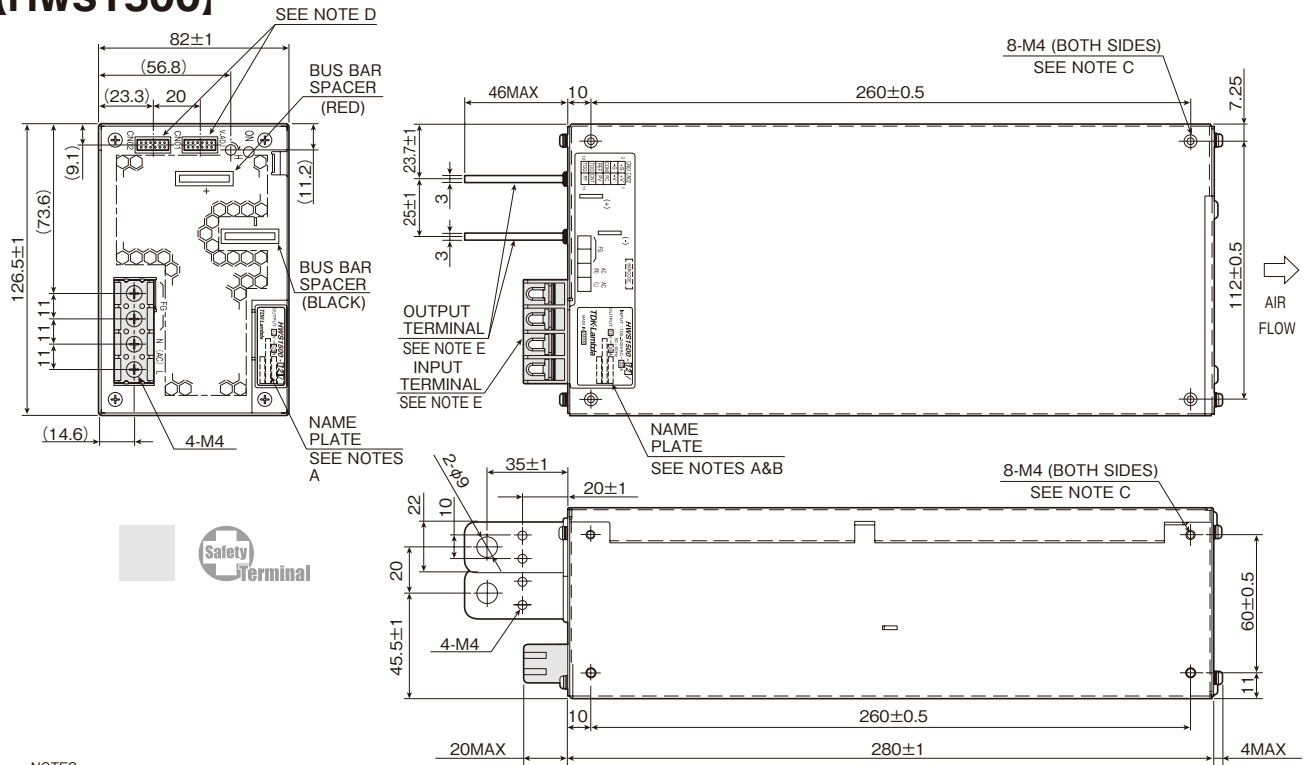

NOTES

- A : MODEL NAME, OPTION, INPUT VOLTAGE RANGE, NOMINAL OUTPUT VOLTAGE, MAXIMUM OUTPUT CURRENT ARE SHOWN HERE IN ACCORDANCE WITH THE SPECIFICATIONS.
- B : COUNTRY OF MANUFACTURE IS SHOWN HERE.
- C : M4 TAPPED HOLES (16) FOR CUSTOMER CHASSIS MOUNTING. (SCREWS MUST NOT PROTRUDE INTO POWER SUPPLY BY MORE THAN 6mm/m.) RECOMMENDED M4 SCREWS TORQUE : 1.27N·m
- D : I/O SIGNAL CONNECTOR
 - CONNECTOR : S12B-PHDSS (LF) (SN) (JST)
 - MATCHING HOUSING : PHDR-12VS (JST)
 - MATCHING CONTACT : SPHD-002T-P0.5 (AWG28 - 24) (JST) OR SPHD-001T-P0.5 (AWG26 - 22) (JST) OR BPHD-001T-P0.5 (AWG26 - 22) (JST)
 - HAND CRIMPING TOOL : YRS-620 (SPHD-002T-P0.5) (JST) YC-610R (SPHD-001T-P0.5) (JST) YC-610R (BPHD-001T-P0.5) (JST)
- E : RECOMMENDED TORQUE FOR THE TERMINAL PIECE.
 - INPUT TERMINAL (M4 SCREW) : 1.27N·m
 - OUTPUT TERMINAL (M8 BOLT & NUT) : 10.8N·m
 - OUTPUT TERMINAL (M4 SCREW) : 1.27N·m

ACCESSORIES

- * ATTACHED CONNECTOR SHORTING +S ~ +V, -S ~ -V, PV ~ REF & CNT ~ TOG ATTACHED ON CN01 AT SHIPMENT

[unit: mm]

Output Derating

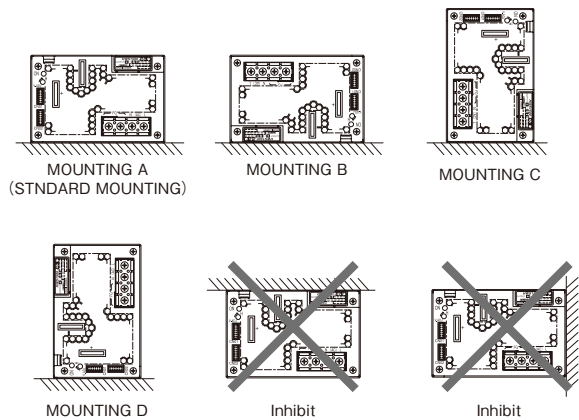
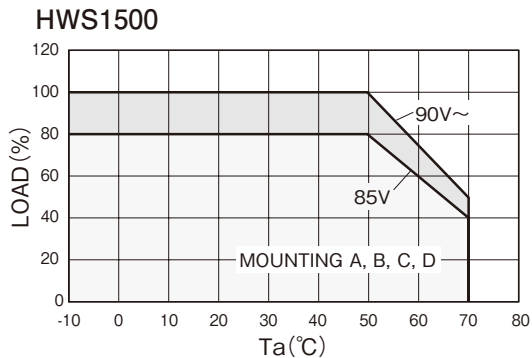

HWS1800T Specifications

| ITEMS/UNITS | | MODEL | HWS1800T-3 | HWS1800T-5 | HWS1800T-6 | HWS1800T-7 | HWS1800T-12 | HWS1800T-15 | HWS1800T-24 | HWS1800T-36 | HWS1800T-48 | HWS1800T-60 | | |
|---------------------------------|--------------------------------------|--|---|------------|------------|------------|-------------|-------------|-------------|-------------|-------------|-------------|--|-----|
| Input | Voltage Range (*2) | V | 3φ AC170 - 265 | | | | | | | | | | | |
| | Frequency (*2) | Hz | 47 - 63 | | | | | | | | | | | |
| | Power Factor (200VAC)(typ) (*1) | | 0.94 | | | | | | | | | | | |
| | Efficiency (200VAC)(typ) (*1)(*8) | % | 75 | 81 | 82 | 84 | | | 88 | | 90 | | | |
| | Current (200VAC)(typ) (*1) | A | 4.5 | 6.0 | | | | | | 7.0 | | | | |
| | Inrush Current (200VAC)(typ) (*3) | A | 40 | | | | | | | | | | | |
| | Leakage Current (240VAC) (max) (*10) | mA | 2.6 | | | | | | | | | | | |
| Output | Nominal Voltage | VDC | 3.3 | 5 | 6 | 7.5 | 12 | 15 | 24 | 36 | 48 | 60 | | |
| | Maximum Current | A | 300 | | 250 | 200 | 125 | 100 | 75 | 50 | 37.5 | 30 | | |
| | Maximum Peak Current (*12) | A | - | | 300 | 240 | 150 | 120 | 105 | 70 | 52.5 | 42 | | |
| | Maximum Power | W | 990 | 1500 | | | | | | 1800 | | | | |
| | Maximum Peak Power (*12) | W | - | | 1800 | | | | 2520 | | | | | |
| | Maximum Line Regulation (*5) | mV | 36 | | | 40 | 48 | 60 | 96 | 144 | 192 | 240 | | |
| | Maximum Load Regulation (*6) | mV | 60 | | | | 72 | 90 | 144 | 216 | 288 | 360 | | |
| | Temperature Coefficient | | Less than 0.02%/°C | | | | | | | | | | | |
| | Ripple & Noise (*4) | Maximum | +25 to +71°C | 150 | | | 200 | | | 250 | | 300 | | 400 |
| | | | 0°C | 200 | | | 200 | | | 250 | | 300 | | 400 |
| | | | -10°C | 220 | | | 250 | | | 300 | | 400 | | 600 |
| | Hold-up Time (typ) (*9) | ms | 20 | | | | | | 18 | | | | | |
| Voltage Adjustable Range | VDC | 2.64-3.96 | 4.0-6.0 | 4.8-7.2 | 6.0-9.0 | 9.6-14.4 | 12.0-18.0 | 19.2-28.8 | 28.8-43.2 | 38.4-52.8 | 48.0-66.0 | | | |
| Over Current Protection (*7) | V | 315.0- | 315.0- | 303.0- | 242.4- | 151.5- | 121.2- | 106.0- | 70.7- | 53.0- | 42.4- | | | |
| Over Voltage Protection (*8) | V | 4.12-4.62 | 6.25-7.0 | 7.5-8.4 | 9.37-10.5 | 15.0-17.4 | 18.7-21.8 | 30.0-34.8 | 45.0-49.7 | 55.2-60.0 | 69.0-75.0 | | | |
| Remote Sensing | | Possible | | | | | | | | | | | | |
| Remote ON/OFF Control | | Possible | | | | | | | | | | | | |
| Output Voltage External Control | | Possible | | | | | | | | | | | | |
| Parallel Operation | | Possible | | | | | | | | | | | | |
| Series Operation | | Possible | | | | | | | | | | | | |
| Monitoring Signal | | PF (Open Collector Output) | | | | | | | | | | | | |
| Line DIP | | Built to meet SEMI-F47 | | | | | | | | | | | | |
| Environment | Operating Temperature (*11) | °C | -10 to +71, Start up -20 to +71 | | | | | | | | | | | |
| | | -10 to +40°C | W | 990 | 1500 | | | | | | 1800 | | | |
| | | +50°C | W | 825 | 1250 | 1500 | | | | 1680 | | | | |
| | | +60°C | W | 660 | 1000 | 1125 | | | | 1300 | | | | |
| | | +71°C | W | 495 | 750 | | | | | | 900 | | | |
| | Storage Temperature | °C | -30 to +85 | | | | | | | | | | | |
| Operating Humidity | %RH | 10 - 90 (No dewdrop) | | | | | | | | | | | | |
| Storage Humidity | %RH | 10 - 95 (No dewdrop) | | | | | | | | | | | | |
| Vibration | | At no operating, 10 - 55Hz (sweep for 1min.) 19.6m/s ² constant, X, Y, Z 1h each. | | | | | | | | | | | | |
| Shock (In package) | | Less than 196.1m/s ² | | | | | | | | | | | | |
| Cooling | | Forced air by blower fan | | | | | | | | | | | | |
| Isolation | Withstand Voltage | | Input - FG : 2kVAC (20mA), Input - Output : 3kVAC (20mA), Output-CNT:100VAC (100mA) for 1min. | | | | | | | | | | | |
| | | | Output-FG : 500VAC (300mA) for 1min | | | | | | | | | | | |
| Standards | Isolation Resistance | | More than 100Mohm Output - FG ... 500VDC | | | | | | | | | | | |
| | | | More than 10Mohm Output - CNT ... 100VDC at 25°C and 70%RH | | | | | | | | | | | |
| | | | Built to meet UL60950-1, CSA60950-1 | | | | | | | | | | | |
| Standards | EMI | | Built to meet EN55011/EN55022-A, FCC-A, VCCI-A. | | | | | | | | | | | |
| | | | Built to meet IEC61000-4-2(Level 2,3), -3(Level 3), -4(Level 3), -5(Level 3,4), -6(Level 3), -8(Level 4), -11 | | | | | | | | | | | |
| Mechanical | Weight (typ) | g | 4000 | | | | | | 3800 | | | | | |
| | Size (W x H x D) | mm | 126.5 x 82 x 280 (Refer to outline drawing) | | | | | | | | | | | |

- (*1) At Ta=25°C and maximum output power.
- (*2) For cases where conformance to various safety specs (UL, CSA) are required, input voltage range will be 200 - 240VAC (50/60Hz).
- (*3) First in-rush current. Not applicable for the in-rush current to noise filter less than 0.2ms.
- (*4) Measure with JEITA RC-9131A probe, bandwidth of scope: 100MHz.
(At 100uF electric capacitor and 0.47uF film capacitor on the test fixture board.)
Between -10 degrees C and 25 degrees C, it becomes the value which connected each value in a straight line.
- (*5) 170 - 265VAC(50/60Hz), constant load.
- (*6) No load-full load, constant input voltage.
- (*7) Constant current limit with automatic recovery. An output will be intercepted if it continues for about 5 seconds. Output current exceeding maximum rated output current for more than 10 seconds continuously will result to output shutdown.
- (*8) OVP circuit will shut down output, manual reset (power cycle) or ON/OFF CNT signal reset.
- (*9) At 200VAC(50/60Hz), nominal output voltage and maximum output current.
- (*10) Measured by the each measuring method of UL, CSA (at 60Hz), Ta=25°C.
- (*11) Ratings - Derating at standard mounting.
- As for other mountings, refer to derating curve.
- (*12) Peak output current is less than 10 seconds, and duty 35% max.

● Recommended EMC Filter



RTEN-5020
Please refer to "TDK-Lambda EMC Filters" catalog.

Outline Drawing

[HWS1800T]

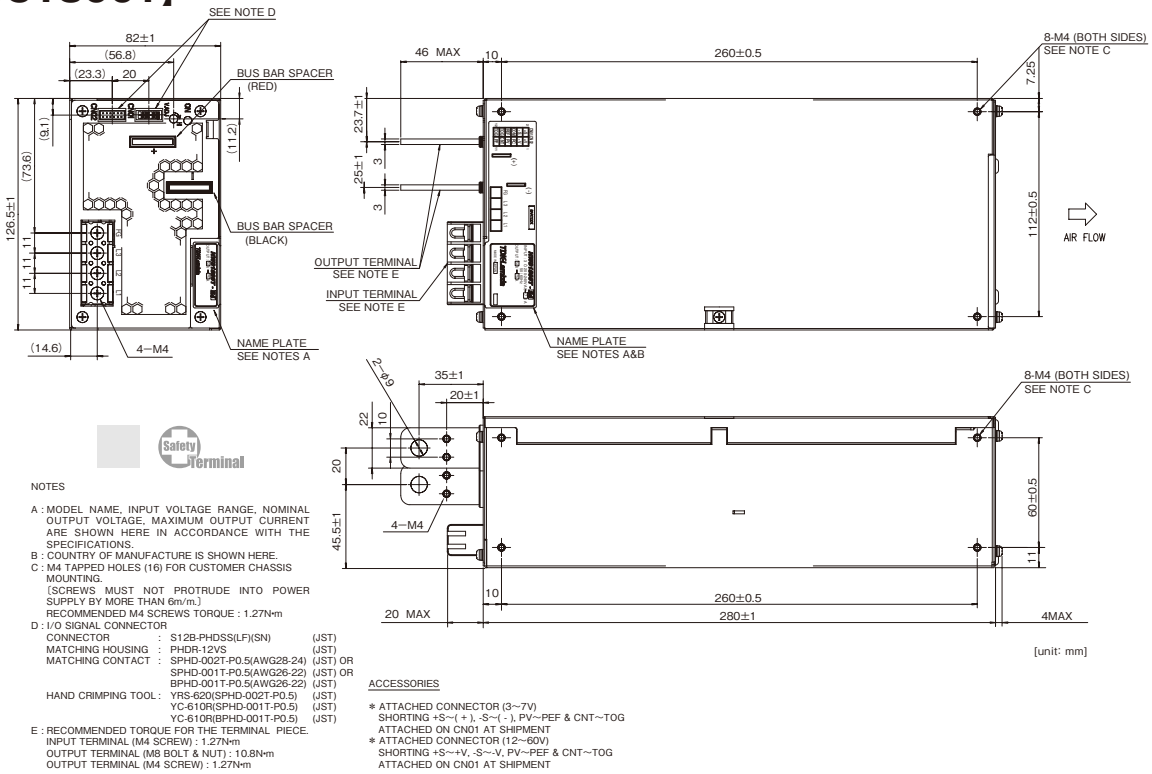

Output Derating

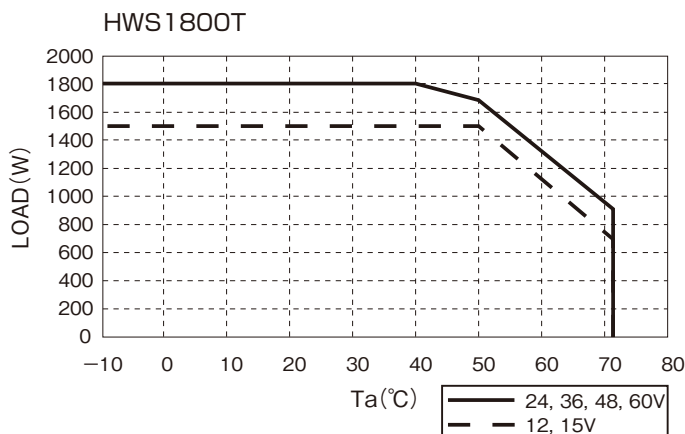
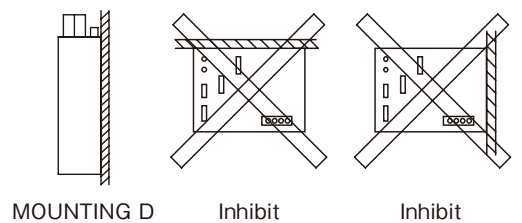
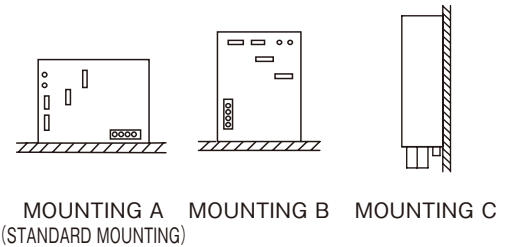
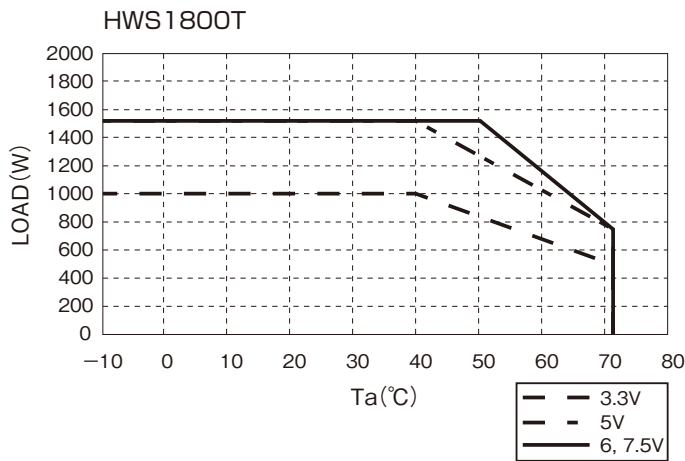

TDK-Lambda

HWS/HD SERIES Single Output 50W-1500W

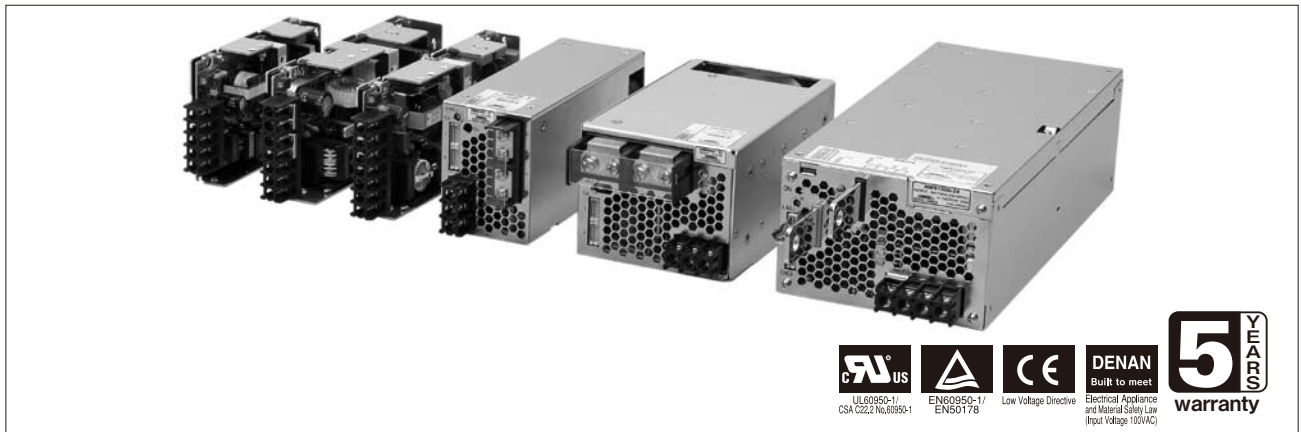

■ Features

- Power supply for harsh environment, heavy industry equipment, etc.
 - Guaranteed start-up at Ta=-40°C. (See note.)
 - Internal board coating
 - Compliant to MIL-STD-810F, the standard for the products for military use (vibration resistance /shock resistance).
- Environmentally-friendly: Conforming to RoHS directives
High-efficiency technology reduces power loss by heat generation. Fan stopping in power-off by external control realizes silence and energy saving.
- Easy to use: All models in the same height of 82mm. Mountable in 2U-height racks without dead space.
- Safety and reliability: “Safety terminal” covering current flowing part secures safety for users. “No screw-dropping” design prevents from losing screws during maintenance operation.
- HWS1500-48 realizes as high efficiency as 90%. Synchronous rectifier circuit improved efficiency of low voltage models by over 10% (HWS150-5).

■ Model naming method

[HWS50-150]
HWS 50 – 5 / HD
 Series name Output power HD : Without cover for harsh environment
 Nominal output voltage
 ex. 3: 3.3V, 5: 5V, 48: 48V

[HWS300-1500]
HWS 300 – 5 / HD
 Series name Output power HD : With cover for harsh environment by forced air cooling (except HWS1000)
 Nominal output voltage
 ex. 3: 3.3V, 5: 5V, 48: 48V

HWS/HD

■ Applications



■ Conformity to RoHS Directive

This means that, in conformity with EU Directive 2002/95/EC, lead, cadmium, mercury, hexavalent chromium, and specific bromine-based flame retardants, PBB and PBDE, have not been used, except for exempted applications.

■ Product Line up

| Output Voltage | 50W | | 100W | | 150W | |
|----------------|----------------|-------------|----------------|--------------|----------------|--------------|
| | Output Current | Model | Output Current | Model | Output Current | Model |
| 3.3V | 10A | HWS50-3/HD | 20A | HWS100-3/HD | 30A | HWS150-3/HD |
| 5V | 10A | HWS50-5/HD | 20A | HWS100-5/HD | 30A | HWS150-5/HD |
| 12V | 4.3A | HWS50-12/HD | 8.5A | HWS100-12/HD | 13A | HWS150-12/HD |
| 15V | 3.5A | HWS50-15/HD | 7A | HWS100-15/HD | 10A | HWS150-15/HD |
| 24V | 2.2A | HWS50-24/HD | 4.5A | HWS100-24/HD | 6.5A | HWS150-24/HD |
| 48V | 1.1A | HWS50-48/HD | 2.1A | HWS100-48/HD | 3.3A | HWS150-48/HD |

| Output Voltage | 300W | | 600W | | 1500W | |
|----------------|-----------------------|--------------|-----------------------|--------------|--------------------------|---------------|
| | Output Current (Peak) | Model | Output Current (Peak) | Model | Output Current (Peak)(*) | Model |
| 3.3V | 60A | HWS300-3/HD | 120A | HWS600-3/HD | — | — |
| 5V | 60A | HWS300-5/HD | 120A | HWS600-5/HD | — | — |
| 12V | 27A | HWS300-12/HD | 53A | HWS600-12/HD | 125A/125A(—) | HWS1500-12/HD |
| 15V | 22A | HWS300-15/HD | 43A | HWS600-15/HD | 100A/100A(—) | HWS1500-15/HD |
| 24V | 14A (16.5A) | HWS300-24/HD | 27A (31A) | HWS600-24/HD | 65A/70A (105A) | HWS1500-24/HD |
| 36V | — | — | — | — | 42A/46.5A (70A) | HWS1500-36/HD |
| 48V | 7A | HWS300-48/HD | 13A | HWS600-48/HD | 32A/32A(—) | HWS1500-48/HD |

The power supply might not start up according to the input voltage and the load condition at the low temperature (-40 < Ta < -10°C). (*) (100Vin/200VIn)
 For details, please refer to “Start-up condition at the low temperature”.

• All specifications are subject to change without notice.

HWS50/HD Specifications

| ITEMS/UNITS | | MODEL | HWS50-3/HD | HWS50-5/HD | HWS50-12/HD | HWS50-15/HD | HWS50-24/HD | HWS50-48/HD |
|------------------------------|---|------------------------------|---|-------------|-------------|-------------|-------------|-------------|
| Input | Voltage Range (*3) | V | AC85 - 265 or DC120 - 370 | | | | | |
| | Frequency (*3) | Hz | 47 - 63 | | | | | |
| | Power Factor (100/200VAC)(typ) (*2) | | 0.98 / 0.90 | 0.99 / 0.95 | | | | |
| | Efficiency (100/200VAC)(typ) (*2) | % | 76 / 78 | 82 / 84 | 81 / 83 | | 82 / 84 | 83 / 85 |
| | Current (100/200VAC)(typ) (*2) | A | 0.5 / 0.25 | 0.7 / 0.35 | | | | |
| | Inrush Current (100/200VAC)(typ) (*4) | A | 14 / 28 Ta=25°C, cold start | | | | | |
| | Leakage Current (*11) | mA | Less than 0.5. (0.2 (typ) at 100VAC / 0.4 (typ) at 230VAC) | | | | | |
| Output | Nominal Voltage | VDC | 3.3 | 5 | 12 | 15 | 24 | 48 |
| | Minimum Current (*1) | A | 0.1 | | 0.04 | | 0.02 | 0.01 |
| | Maximum Current | A | 10 | | 4.3 | 3.5 | 2.2 | 1.1 |
| | Maximum Power | W | 33 | 50 | 51.6 | 52.5 | 52.8 | |
| | Maximum Line Regulation (*6) | mV | 20 | | 48 | 60 | 96 | 192 |
| | Maximum Load Regulation (*7) | mV | 40 | | 96 | 120 | 192 | 384 |
| | Temperature Coefficient | | Less than 0.02% / °C | | | | | |
| | Maximum Ripple & Noise (0≤Ta≤71°C) (*5) | mVp-p | 120 | | 150 | | 200 | |
| | Maximum Ripple & Noise (-10≤Ta< 0°C) (*5) | mVp-p | 160 | | 180 | | 240 | |
| | Hold-up Time (typ) (*10) | ms | 20 | | | | | |
| | Voltage Adjustable Range | VDC | 2.97 - 3.96 | 4.0 - 6.0 | 9.6 - 14.4 | 12.0 - 18.0 | 19.2 - 28.8 | 38.4 - 52.8 |
| | Function | Over Current Protection (*8) | A | >10.5 | | >4.51 | >3.67 | >2.31 |
| Over Voltage Protection (*9) | | VDC | 4.13 - 4.95 | 6.25 - 7.25 | 15.0 - 17.4 | 18.8 - 21.8 | 30.0 - 34.8 | 55.2 - 64.8 |
| Remote Sensing | | | - | | | | | |
| Parallel Operation | | | - | | | | | |
| Series Operation | | | Possible | | | | | |
| Line DIP | | | Designed to meet SEMI-F47 (200VAC Line only) | | | | | |
| Operating Temperature (*12) | | °C | -10 to +71 (-10 to +50: 100%, +60: 60%, +71: 20%) Guarantee start up at -40 to -10°C | | | | | |
| Storage Temperature | °C | -40 to +85 | | | | | | |
| Operating Humidity | %RH | 30 - 90 (No dewdrop) | | | | | | |
| Storage Humidity | %RH | 10 - 95 (No dewdrop) | | | | | | |
| Environment | Vibration (*13) | | At no operating, 10 - 55Hz (sweep for 1min) 19.6m/s² constant, X, Y, Z 1hour each. Designed to meet MIL-STD-810F 514.5 Category 4, 10 | | | | | |
| | Shock (In package) | | Less than 196.1m/s² Designed to meet MIL-STD-810F 516.5 Procedure I, VI | | | | | |
| | Cooling | | Convection cooling | | | | | |
| Isolation | Withstand Voltage | | Input - FG : 2kVAC (20mA), Input - Output : 3kVAC (20mA) Output - FG : 500VAC (100mA) for 1min | | | | | |
| | Isolation Resistance | | More than 100MΩ at 25°C and 70%RH Output - FG : 500VDC | | | | | |
| Standards | Safety Standards (*14) | | Approved by UL60950-1, CSA C22.2 No.60950-1, EN60950-1, EN50178 Designed to meet UL508, DENAN | | | | | |
| | PFHC | | Designed to meet IEC61000-3-2 | | | | | |
| | EMI | | Designed to meet EN55011/EN55022-B, FCC-B, VCCI-B | | | | | |
| | Immunity | | Designed to meet IEC61000-4-2(Level 2,3), -3(Level 3), -4(Level 3), -5(Level 3,4), -6(Level 3), -8(Level 4), -11 | | | | | |
| Mechanical | Weight (typ) | g | 280 | | | | | |
| | Size (W x H x D) | mm | 26.5 x 82 x 120 (Refer to outline drawing) | | | | | |

(*1) Output voltage might be unstable when start up at -40 to -10°C and no load. In that case, apply minimum output current.

(*2) At 100/200VAC, Ta=25°C and maximum output power.

(*3) For cases where conformance to various safety specs (UL, CSA, EN) are required, to be described as 100 - 240VAC (50/60Hz).

(*4) Not applicable for the in-rush current to noise filter for less than 0.2ms.

(*5) Measure with JEITA RC-9131A probe, bandwidth of scope :100MHz.

(*6) 85 - 265VAC, constant load.

(*7) No load-Full load, constant input voltage.

(*8) Constant current limit and hiccup with automatic recovery. Not operate at over load or dead short condition for more than 30 seconds.

(*9) OVP circuit will shutdown output, manual reset (re power on).

(*10) At 100/200VAC, nominal output voltage and maximum output current.

(*11) Measured by the each measuring method of UL, CSA, EN and DENAN (at 60Hz).

(*12) Ratings - Derating at standard mounting.
- Load (%) is percent of maximum output power or maximum output current, whichever is greater.
- As for other mountings, refer to derating curve.
- For conditions of start up at -40°C to -10°C, refer to derating curve.

(*13) Category 4 exposure levels : Track transportation over U.S. highways, composite two-wheeled trailer.

(*14) As for DENAN, dsigned to meet at 100VAC.

● Recommended EMC Filter

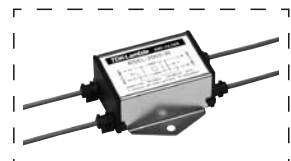

RSEL-2001W

Please refer to "TDK-Lambda EMC Filters" catalog.

Outline Drawing

[HWS50/HD]

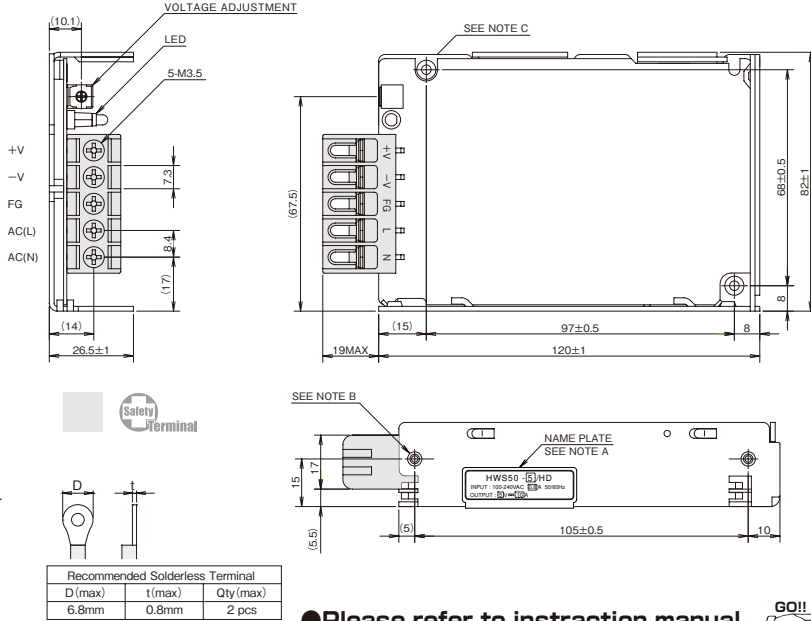

NOTES

- A: MODEL NAME, INPUT VOLTAGE RANGE, NOMINAL OUTPUT VOLTAGE, MAXIMUM OUTPUT CURRENT AND COUNTRY OF MANUFACTURE ARE SHOWN HERE IN ACCORDANCE WITH THE SPECIFICATIONS.
- B: M3 EMBOSSED, TAPPED AND COUNTER-SUNK HOLES (2) FOR CUSTOMER CHASSIS MOUNTING. SCREWS MUST NOT PROTRUDE INTO POWER SUPPLY BY MORE THAN 6m/m.
- C: M3 TAPPED HOLES (2) FOR CUSTOMER CHASSIS MOUNTING. SCREWS MUST NOT PROTRUDE INTO POWER SUPPLY BY MORE THAN 6m/m.

● Please refer to instruction manual. **GO!! A-155**

HWS/HD

Output Derating

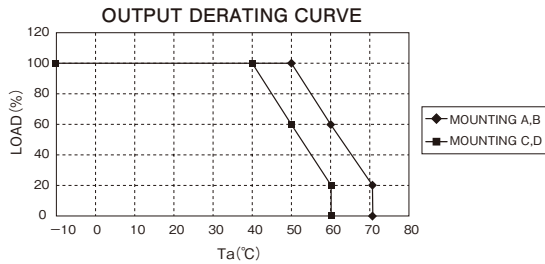

***COOLING : CONVECTION COOLING**

| Ta (°C) | LOAD (%) | |
|------------|---------------|---------------|
| | MOUNTING A, B | MOUNTING C, D |
| -10 to +40 | 100 | 100 |
| 50 | 100 | 60 |
| 60 | 60 | 20 |
| 71 | 20 | - |

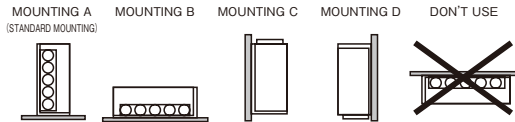

Start-up condition at low temperature (Ta = -40 to -10°C)

● DERATING TO START UP AT Ta : -30 to -10°C

| Input Voltage (VAC) | LOAD (%) | |
|---------------------|------------------|--|
| | Normal start up. | Stable output after 1 min from start up. |
| 85 - 170 | 80 | 100 |
| 170 - 265 | 100 | 100 |

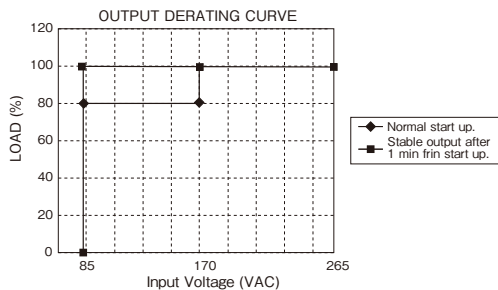

=NOTES=

- *At Ta : -30 to -10°C.
- *Output voltage : Nominal output voltage.
- *Input voltage : Not gradual start up.
- *Do not use the load that is constant current mode.
- *Avoid forced air cooling. It is assumed that inside of power supply is heated by self-heating within 1 minutes.
- *No dewdrop.
- *Output voltage might be unstable at no load. In that case, apply minimum output current.
- *Pay attention to above items before using the unit. Incorrect usage could lead to unstable output voltage.

● DERATING TO START UP AT Ta : -40 to -30°C

| Input Voltage (VAC) | LOAD (%) | |
|---------------------|------------------|--|
| | Normal start up. | Stable output after 3 min from start up. |
| 90 | 30 | 50 |
| 170 | 30 | 50 |

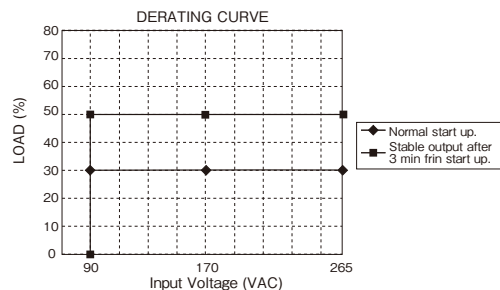

=NOTES=

- *At Ta : -40 to -10°C.
- *Output voltage : Nominal output voltage.
- *Input voltage : Not operate at 85 - 90VAC, and not gradual start up.
- *Do not use the load that is constant current mode.
- *Avoid forced air cooling. It is assumed that inside of power supply is heated by self-heating within 3 minutes.
- *No dewdrop.
- *Output voltage might be unstable at no load. In that case, apply minimum output current.
- *Pay attention to above items before using the unit. Incorrect usage could lead to unstable output voltage.

HWS100/HD Specifications

| ITEMS/UNITS | | MODEL | HWS100-3/HD | HWS100-5/HD | HWS100-12/HD | HWS100-15/HD | HWS100-24/HD | HWS100-48/HD |
|------------------------------|---|--|---|-------------|--------------|--------------|--------------|--------------|
| Input | Voltage Range (*3) | V | AC85 - 265 or DC120 - 370 | | | | | |
| | Frequency (*3) | Hz | 47 - 63 | | | | | |
| | Power Factor (100/200VAC)(typ) (*2) | | 0.98 / 0.90 | 0.99 / 0.95 | | | | |
| | Efficiency (100/200VAC)(typ) (*2) | % | 78 / 81 | 83 / 86 | | | | 84 / 87 |
| | Current (100/200VAC)(typ) (*2) | A | 0.9 / 0.45 | 1.3 / 0.65 | | | | |
| | Inrush Current (100/200VAC)(typ) (*4) | A | 14 / 28, Ta=25°C, cold start | | | | | |
| Leakage Current (*11) | mA | Less than 0.5. (0.2 (typ) at 100VAC / 0.4 (typ) at 230VAC) | | | | | | |
| Output | Nominal Voltage | VDC | 3.3 | 5 | 12 | 15 | 24 | 48 |
| | Minimum Current (*1) | A | 0.2 | | 0.09 | 0.07 | 0.05 | 0.02 |
| | Maximum Current | A | 20 | | 8.5 | 7 | 4.5 | 2.1 |
| | Maximum Power | W | 66 | 100 | 102 | 105 | 108 | 100.8 |
| | Maximum Line Regulation (*6) | mV | 20 | | 48 | 60 | 96 | 192 |
| | Maximum Load Regulation (*7) | mV | 40 | | 96 | 120 | 192 | 384 |
| | Temperature Coefficient | | Less than 0.02% / °C | | | | | |
| | Maximum Ripple & Noise (0≤Ta≤71°C) (*5) | mVp-p | 120 | | 150 | | | 200 |
| | Maximum Ripple & Noise (-10≤Ta< 0°C) (*5) | mVp-p | 160 | | 180 | | | 240 |
| | Hold-up Time (typ) (*10) | ms | 20 | | | | | |
| | Voltage Adjustable Range | VDC | 2.97 - 3.96 | 4.0 - 6.0 | 9.6 - 14.4 | 12.0 - 18.0 | 19.2 - 28.8 | 38.4 - 52.8 |
| Over Current Protection (*8) | A | >21.0 | | >8.92 | >7.35 | >4.72 | >2.20 | |
| Over Voltage Protection (*9) | VDC | 4.13 - 4.95 | 6.25 - 7.25 | 15.0 - 17.4 | 18.8 - 21.8 | 30.0 - 34.8 | 55.2 - 64.8 | |
| Function | Remote Sensing | | Possible | | | | | |
| | Parallel Operation | | - | | | | | |
| | Series Operation | | Possible | | | | | |
| | Line DIP | | Designed to meet SEMI-F47 (200VAC Line only) | | | | | |
| Environment | Operating Temperature (*12) | °C | -10 to +71 (-10 to +50: 100%, +60: 60%, +71: 20%) Guarantee start up at -40 to -10 | | | | | |
| | Storage Temperature | °C | -40 to +85 | | | | | |
| | Operating Humidity | %RH | 30 - 90 (No dewdrop) | | | | | |
| | Storage Humidity | %RH | 10 - 95 (No dewdrop) | | | | | |
| | Vibration (*13) | | At no operating, 10~55Hz (sweep for 1min) 19.6m/s² constant, X, Y, Z 1hour each. Designed to meet MIL-STD-810F 514.5 Category 4, 10 | | | | | |
| | Shock (In package) | | Less than 196.1m/s² Designed to meet MIL-STD-810F 516.5 Procedure I, VI | | | | | |
| | Cooling | | Convection cooling | | | | | |
| Isolation | Withstand Voltage | | Input - FG : 2kVAC (20mA), Input - Output : 3kVAC (20mA) Output - FG : 500VAC (100mA) for 1min | | | | | |
| | Isolation Resistance | | More than 100MΩ at 25°C and 70%RH Output - FG : 500VDC | | | | | |
| Standards | Safety Standards (*14) | | Approved by UL60950-1, CSA C22.2 No.60950-1, EN60950-1, EN50178 Designed to meet UL508, DENAN | | | | | |
| | PFHC | | Designed to meet IEC61000-3-2 | | | | | |
| | EMI | | Designed to meet EN55011/EN55022-B, FCC-B, VCCI-B | | | | | |
| | Immunity | | Designed to meet IEC61000-4-2(Level 2,3), -3(Level 3), -4(Level 3), -5(Level 3,4), -6(Level 3), -8(Level 4), -11 | | | | | |
| Mechanical | Weight (typ) | g | 450 | | | | | |
| | Size (W x H x D) | mm | 28 x 82 x 160 (Refer to outline drawing) | | | | | |

HWS
/HD

(*1) Output voltage might be unstable when start up at -40 to -10°C and no load. In that case, apply minimum output current.

(*2) At 100/200VAC, Ta=25°C and maximum output power.

(*3) For cases where conformance to various safety specs (UL, CSA, EN) are required, to be described as 100 - 240VAC (50/60Hz).

(*4) Not applicable for the in-rush current to noise filter for less than 0.2ms.

(*5) Measure with JEITA RC-9131A probe, bandwidth of scope :100MHz.

(*6) 85 - 265VAC, constant load.

(*7) No load-full load, constant input voltage.

(*8) Constant current limit and hiccup with automatic recovery.
Not operate at over load or dead short condition for more than 30 seconds.

(*9) OVP circuit will shutdown output, manual reset (re power on).

(*10) At 100/200VAC, nominal output voltage and maximum output current.

(*11) Measured by the each measuring method of UL, CSA, EN and DENAN (at 60Hz).

(*12) Ratings - Derating at standard mounting.
- Load (%) is percent of maximum output power or maximum output current, whichever is greater.
- As for other mountings, refer to derating curve.
- For conditions of start up at -40°C to -10°C, refer to derating curve.

(*13) Category 4 exposure levels : Track transportation over U.S. highways, composite two-wheeled trailer.

(*14) As for DENAN, dsigned to meet at 100VAC.

Recommended EMC Filter

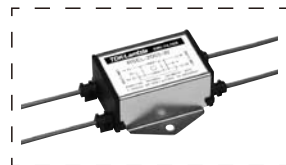

RSEL-2002W

Please refer to "TDK-Lambda EMC Filters" catalog.

Outline Drawing

[HWS100/HD]

NOTES

A: MODEL NAME, INPUT VOLTAGE RANGE, NOMINAL OUTPUT VOLTAGE, MAXIMUM OUTPUT CURRENT AND COUNTRY OF MANUFACTURE ARE SHOWN HERE IN ACCORDANCE WITH THE SPECIFICATIONS.

B: M3 EMBOSSED, TAPPED AND COUNTERSUNK HOLES (2) FOR CUSTOMER CHASSIS MOUNTING. SCREWS MUST NOT PROTRUDE INTO POWER SUPPLY BY MORE THAN 6m/m.

C: M3 TAPPED HOLES (2) FOR CUSTOMER CHASSIS MOUNTING. SCREWS MUST NOT PROTRUDE INTO POWER SUPPLY BY MORE THAN 6m/m.

ACCESSORIES

* SHORT PIECE (NET 2) FOR SHORTING PURPOSE (+S to +V, -S to -V) : MOUNTED AT TIME OF SHIPMENT.

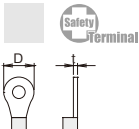
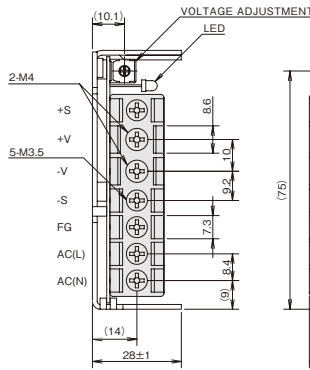

| Terminal | Recommended Solderless Terminal | | |
|----------|---------------------------------|---------|-----------|
| | D (max) | t (max) | Qty (max) |
| +V / -V | 8.1mm | 0.8mm | 2pcs |
| | | 1.0mm | 1pc |
| Others | 6.8mm | 0.8mm | 2pcs |

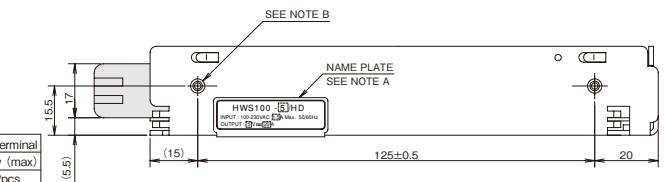
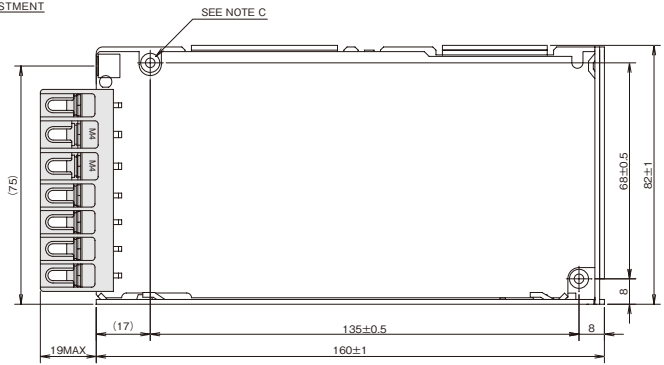

● Please refer to instruction manual. **GO!!** A-155

HWS/HD

Output Derating

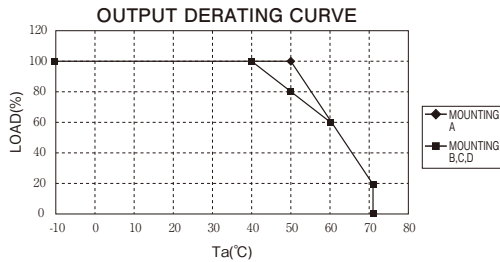

***COOLING : CONVECTION COOLING**

| Ta(°C) | LOAD(%) | |
|------------|------------|------------------|
| | MOUNTING A | MOUNTING B, C, D |
| -10 to +40 | 100 | 100 |
| 50 | 100 | 80 |
| 60 | 60 | 60 |
| 71 | 20 | 20 |

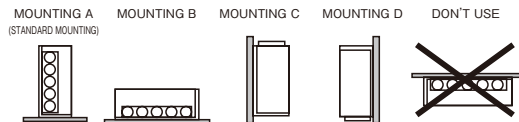

Start-up condition at low temperature (Ta = -40 to -10°C)

● DERATING TO START UP AT Ta : -30 to -10°C

| Input Voltage (VAC) | LOAD(%) | |
|---------------------|------------------|--|
| | Normal start up. | Stable output after 1 min from start up. |
| 85 - 170 | 70 | 100 |
| 170 - 265 | 100 | 100 |

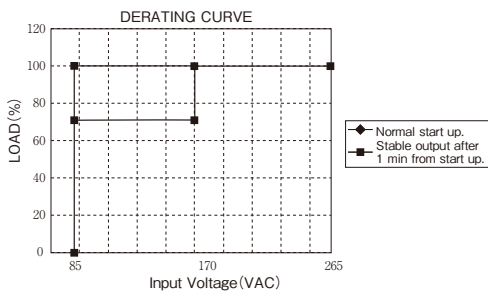

=NOTES=

- *At Ta : -30 to -10°C .
- *Output voltage : Nominal output voltage.
- *Input voltage : Not gradual start up.
- *Do not use the load that is constant current mode.
- *Avoid forced air cooling. It is assumed that inside of power supply is heated by self-heating within 1 minutes.
- *No dewdrop.
- *Output voltage might be unstable at no load. In that case, apply minimum output current.
- *Pay attention to above items before using the unit. Incorrect usage could lead to unstable output voltage.

● DERATING TO START UP AT Ta : -40 to -30°C

| Input Voltage (VAC) | LOAD(%) | |
|---------------------|------------------|--|
| | Normal start up. | Stable output after 3 min from start up. |
| 90 - 170 | 30 | 60 |
| 170 - 265 | 50 | 70 |

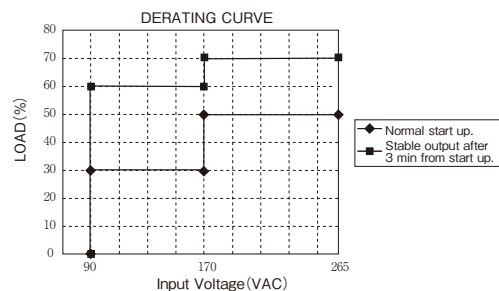

=NOTES=

- *At Ta : -40 to -10°C .
- *Output voltage : Nominal output voltage.
- *Input voltage : Not operate at 85 - 90VAC, and not gradual start up.
- *Do not use the load that is constant current mode.
- *Avoid forced air cooling. It is assumed that inside of power supply is heated by self-heating within 3 minutes.
- *No dewdrop.
- *Output voltage might be unstable at no load. In that case, apply minimum output current.
- *Pay attention to above items before using the unit. Incorrect usage could lead to unstable output voltage.

HWS150/HD Specifications

| ITEMS/UNITS | | MODEL | HWS150-3/HD | HWS150-5/HD | HWS150-12/HD | HWS150-15/HD | HWS150-24/HD | HWS150-48/HD |
|-----------------------|---|--|---|-------------|--------------|--------------|--------------|--------------|
| Input | Voltage Range (*3) | V | AC85 - 265 or DC120 - 370 | | | | | |
| | Frequency (*3) | Hz | 47 - 63 | | | | | |
| | Power Factor (100/200VAC)(typ) (*2) | | 0.98 / 0.90 | 0.99 / 0.95 | | | | |
| | Efficiency (100/200VAC)(typ) (*2) | % | 78 / 81 | 83 / 86 | | | 85 / 88 | |
| | Current (100/200VAC)(typ) (*2) | A | 1.3 / 0.65 | 1.9 / 0.95 | | | | |
| | Inrush Current (100/200VAC)(typ) (*4) | A | 14 / 28, Ta=25°C, cold start | | | | | |
| Leakage Current (*11) | mA | Less than 0.5. (0.2 (typ) at 100VAC / 0.4 (typ) at 230VAC) | | | | | | |
| Output | Nominal Voltage | VDC | 3.3 | 5 | 12 | 15 | 24 | 48 |
| | Minimum Current (*1) | A | 0.3 | | 0.1 | | 0.07 | 0.03 |
| | Maximum Current | A | 30 | | 13 | 10 | 6.5 | 3.3 |
| | Maximum Power | W | 99 | 150 | 156 | 150 | 156 | 158.4 |
| | Maximum Line Regulation (*6) | mV | 20 | | 48 | 60 | 96 | 192 |
| | Maximum Load Regulation (*7) | mV | 40 | | 96 | 120 | 192 | 384 |
| | Temperature Coefficient | | Less than 0.02% / °C | | | | | |
| | Maximum Ripple & Noise (0≤Ta≤71°C) (*5) | mVp-p | 120 | | 150 | | 200 | |
| | Maximum Ripple & Noise (-10≤Ta< 0°C) (*5) | mVp-p | 160 | | 180 | | 240 | |
| | Hold-up Time (typ) (*10) | ms | 20 | | | | | |
| | Voltage Adjustable Range | VDC | 2.97 - 3.96 | 4.0 - 6.0 | 9.6 - 14.4 | 12.0 - 18.0 | 19.2 - 28.8 | 38.4 - 52.8 |
| Function | Over Current Protection (*8) | A | >31.5 | | >13.6 | >10.5 | >6.82 | >3.46 |
| | Over Voltage Protection (*9) | VDC | 4.13 - 4.95 | 6.25 - 7.25 | 15.0 - 17.4 | 18.8 - 21.8 | 30.0 - 34.8 | 55.2 - 64.8 |
| | Remote Sensing | | Possible | | | | | |
| | Parallel Operation | | - | | | | | |
| | Series Operation | | Possible | | | | | |
| Line DIP | | Designed to meet SEMI-F47 (200VAC Line only) | | | | | | |
| Environment | Operating Temperature (*12) | °C | -10 to +71 (-10 to +50: 100%, +60: 60%, +71: 20%) Guarantee start up at -40 to -10 | | | | | |
| | Storage Temperature | °C | -40 to +85 | | | | | |
| | Operating Humidity | %RH | 30 - 90 (No dewdrop) | | | | | |
| | Storage Humidity | %RH | 10 - 95 (No dewdrop) | | | | | |
| | Vibration (*13) | | At no operating, 10 - 55Hz (sweep for 1min) 19.6m/s² constant, X, Y, Z 1hour each. Designed to meet MIL-STD-810F 514.5 Category 4, 10 | | | | | |
| | Shock (In package) | | Less than 196.1m/s² Designed to meet MIL-STD-810F 516.5 Procedure I, VI | | | | | |
| Isolation | Cooling | | Convection cooling | | | | | |
| | Withstand Voltage | | Input - FG : 2kVAC (20mA), Input - Output : 3kVAC (20mA) Output - FG : 500VAC (100mA) for 1min | | | | | |
| Standards | Isolation Resistance | | More than 100MΩ at 25°C and 70%RH Output - FG : 500VDC | | | | | |
| | Safety Standards (*14) | | Approved by UL60950-1, CSA C22.2 No.60950-1, EN60950-1, EN50178 Designed to meet UL508, DENAN | | | | | |
| | PFHC | | Designed to meet IEC61000-3-2 | | | | | |
| | EMI | | Designed to meet EN55011/EN55022-B, FCC-B, VCCI-B | | | | | |
| Mechanical | Immunity | | Designed to meet IEC61000-4-2(Level 2,3), -3(Level 3), -4(Level 3), -5(Level 3,4), -6(Level 3), -8(Level 4), -11 | | | | | |
| | Weight (typ) | g | 500 | | | | | |
| | Size (W x H x D) | mm | 37 x 82 x 160 (Refer to outline drawing) | | | | | |

(*1) Output voltage might be unstable when start up at -40 to -10°C and no load. In that case, apply minimum output current.

(*2) At 100/200VAC, Ta=25°C and maximum output power.

(*3) For cases where conformance to various safety specs (UL, CSA, EN) are required, to be described as 100 - 240VAC (50/60Hz).

(*4) Not applicable for the in-rush current to noise filter for less than 0.2ms.

(*5) Measure with JEITA RC-9131A probe, bandwidth of scope :100MHz.

(*6) 85 - 265VAC, constant load.

(*7) No load-Full load, constant input voltage.

(*8) Constant current limit and hiccup with automatic recovery.
Not operate at over load or dead short condition for more than 30 seconds.

(*9) OVP circuit will shutdown output, manual reset (re power on).

(*10) At 100/200VAC, nominal output voltage and maximum output current.

(*11) Measured by the each measuring method of UL, CSA, EN and DENAN (at 60Hz).

(*12) Ratings - Derating at standard mounting.
- Load (%) is percent of maximum output power or maximum output current, whichever is greater.
- As for other mountings, refer to derating curve.
- For conditions of start up at -40°C to -10°C, refer to derating curve.

(*13) Category 4 exposure levels : Track transportation over U.S. highways, composite two-wheeled trailer.

(*14) As for DENAN, dsigned to meet at 100VAC.

● Recommended EMC Filter

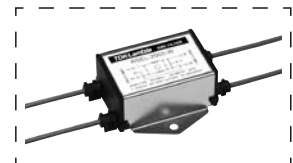

RSEL-2003W

Please refer to "TDK-Lambda EMC Filters" catalog.

Outline Drawing

[HWS150/HD]

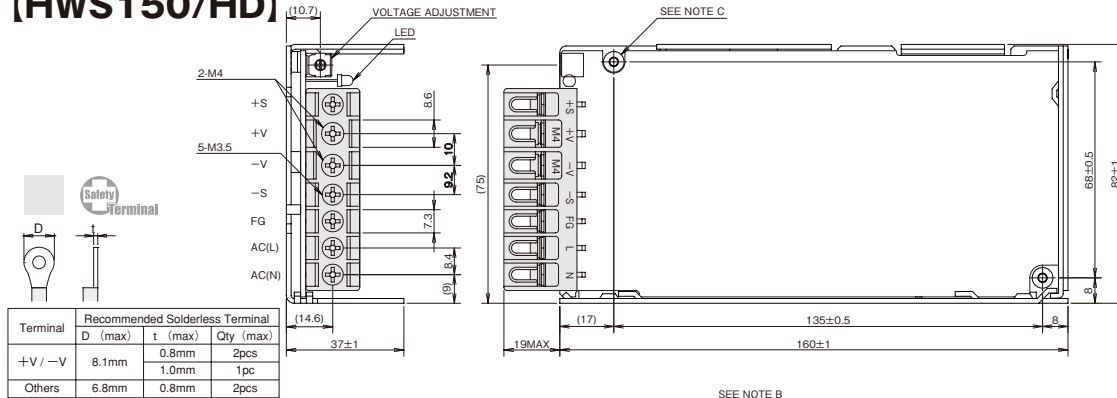

NOTES

- A: MODEL NAME, INPUT VOLTAGE RANGE, NOMINAL OUTPUT VOLTAGE, MAXIMUM OUTPUT CURRENT AND COUNTRY OF MANUFACTURE ARE SHOWN HERE IN ACCORDANCE WITH THE SPECIFICATIONS.
- B: M3 EMBOSSED, TAPPED AND COUNTERSUNK HOLES (2) FOR CUSTOMER CHASSIS MOUNTING. SCREWS MUST NOT PROTRUDE INTO POWER SUPPLY BY MORE THAN 6mm.
- C: M3 TAPPED HOLES (2) FOR CUSTOMER CHASSIS MOUNTING. SCREWS MUST NOT PROTRUDE INTO POWER SUPPLY BY MORE THAN 6mm.

ACCESSORIES

- * SHORT PIECE (NET 2) FOR SHORTING PURPOSE (+S ~ +V, -S ~ -V) : MOUNTED AT TIME OF SHIPMENT.

● Please refer to instruction manual. **GO!! A-155**

Output Derating

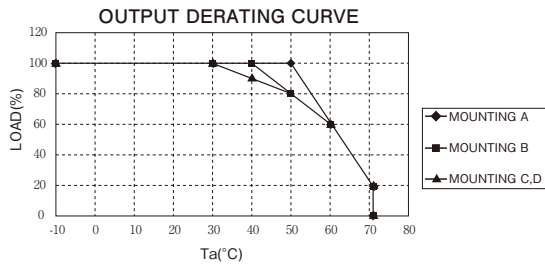

*COOLING : CONVECTION COOLING

| Ta(°C) | LOAD(%) | | |
|------------|------------|------------|---------------|
| | MOUNTING A | MOUNTING B | MOUNTING C, D |
| -10 to +30 | 100 | 100 | 100 |
| 40 | 100 | 100 | 90 |
| 50 | 100 | 80 | 80 |
| 60 | 60 | 60 | 60 |
| 71 | 20 | 20 | 20 |

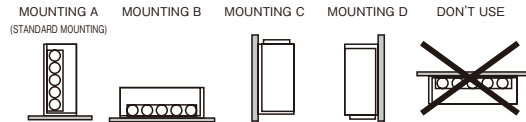

Start-up condition at low temperature (Ta = -40 to -10°C)

● DERATING TO START UP AT Ta : -30 to -10°C

| Input Voltage (VAC) | LOAD(%) | |
|---------------------|------------------|--|
| | Normal start up. | Stable output after 1 min from start up. |
| 85 - 170 | 70 | 100 |
| 170 - 265 | 80 | 100 |

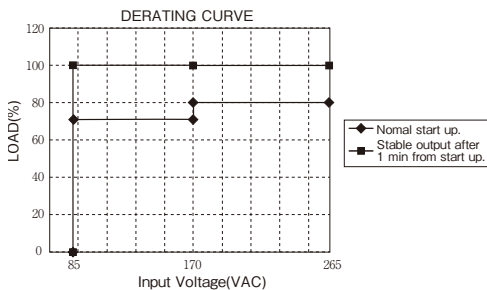

=NOTES=

- *At Ta : -30 to -10°C.
- *Output voltage : Nominal output voltage.
- *Input voltage : Not gradual start up.
- *Do not use the load that is constant current mode.
- *Avoid forced air cooling. It is assumed that inside of power supply is heated by self-heating within 1 minutes.
- *No dewdrop.
- *Output voltage might be unstable at no load. In that case, apply minimum output current.
- *Pay attention to above items before using the unit. Incorrect usage could lead to unstable output voltage.

● DERATING TO START UP AT Ta : -40 to -30°C

| Input Voltage (VAC) | LOAD(%) | |
|---------------------|------------------|--|
| | Normal start up. | Stable output after 3 min from start up. |
| 90 - 170 | - | 20 |
| 170 - 265 | 10 | 40 |

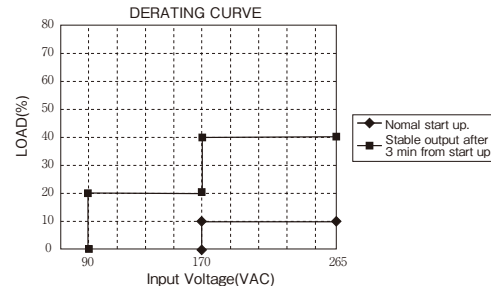

=NOTES=

- *At Ta : -40 to -10°C.
- *Output voltage : Nominal output voltage.
- *Input voltage : Not operate at 85 - 90VAC, and not gradual start up.
- *Do not use the load that is constant current mode.
- *Avoid forced air cooling. It is assumed that inside of power supply is heated by self-heating within 3 minutes.
- *No dewdrop.
- *Output voltage might be unstable at no load. In that case, apply minimum output current.
- *Pay attention to above items before using the unit. Incorrect usage could lead to unstable output voltage.

HWS300/HD Specifications

| ITEMS/UNITS | | MODEL | HWS300-3/HD | HWS300-5/HD | HWS300-12/HD | HWS300-15/HD | HWS300-24/HD | HWS300-48/HD |
|-------------|---|-------|--|-------------|--------------|--------------|--------------|--------------|
| Input | Voltage Range (*3) | V | AC85 - 265 or DC120 - 330 | | | | | |
| | Frequency (*3) | Hz | 47 - 63 | | | | | |
| | Power Factor (100/200VAC)(typ) (*2) | | 0.99 / 0.95 | | | | | |
| | Efficiency (100/200VAC)(typ) (*2) | % | 74 / 77 | 79 / 82 | 80 / 83 | | 82 / 85 | |
| | Current (100/200VAC)(typ) (*2) | A | 2.7 / 1.4 | 3.8 / 1.9 | 4.1 / 2.1 | | | |
| | Inrush Current (100/200VAC)(typ) (*4) | A | 20 / 40 | | | | | |
| Output | Leakage Current (*11) | mA | Less than 0.75. (0.2 (typ) at 100VAC / 0.44 (typ) at 230VAC) | | | | | |
| | Nominal Voltage | VDC | 3.3 | 5 | 12 | 15 | 24 | 48 |
| | Maximum Current (*1) | A | 60 | | 27 | 22 | 14 (16.5) | 7 |
| | Maximum Power | W | 198 | 300 | 324 | 330 | 336 | |
| | Maximum Line Regulation (*6) | mV | 20 | | 48 | 60 | 96 | 192 |
| | Maximum Load Regulation (*7) | mV | 30 | | 72 | 90 | 144 | 288 |
| | Temperature Coefficient | | Less than 0.02% / °C | | | | | |
| | Maximum Ripple & Noise (0_{sTa}<70°C) (*5) | mVp-p | 120 | | 150 | | 350 | |
| | Maximum Ripple & Noise (-10_{sTa}<0°C) (*5) | mVp-p | 180 | | 200 | | 400 | |
| | Hold-up Time (typ) (*10) | ms | 20 | | | | | |
| | Voltage Adjustable Range | VDC | 2.64-3.96 | 4.0-6.0 | 9.6-14.4 | 12.0-18.0 | 19.2-28.8 | 38.4-52.8 |
| Function | Over Current Protection (*8) | A | >63 | >63 | >28.4 | >23.1 | >16.7 | >7.4 |
| | Over Voltage Protection (*9) | VDC | 4.13-4.95 | 6.25-7.25 | 15.0-17.4 | 18.8-21.8 | 30.0-34.8 | 55.2-64.8 |
| | Remote Sensing | | Possible | | | | | |
| | Remote ON/OFF Control | | Possible | | | | | |
| | Parallel Operation | | Possible | | | | | |
| | Series Operation | | Possible | | | | | |
| | Monitoring Signal | | PF (Open collector output) | | | | | |
| | Line DIP | | Designed to meet SEMI-F47 (200VAC Line only) | | | | | |
| Environment | Operating Temperature (*12)(*13) | °C | -10 to +71 (-10 to +50: 100%, +71: 50%) Guarantee Start up at -40 to -10 | | | | | |
| | Storage Temperature | °C | -40 to +85 | | | | | |
| | Operating Humidity | %RH | 10 - 90 (No dewdrop) | | | | | |
| | Storage Humidity | %RH | 10 - 95 (No dewdrop) | | | | | |
| | Vibration (*14) | | At no operating, 10 - 55Hz (sweep for 1min) 19.6m/s ² constant, X, Y, Z 1hour each. Designed to meet MIL-STD-810F 514.5 Category 4,10 | | | | | |
| | Shock (In package) | | Less than 196.1m/s ² Designed to meet MIL-STD-810F 516.5 Procedure I, VI | | | | | |
| | Cooling | | Forced air by blower fan | | | | | |
| Isolation | Withstand Voltage | | Input - FG : 2.5kVAC (20mA), Input - Output : 3kVAC (20mA) Output - FG: 500VAC (100mA), Output-CNT: 100VAC(100mA) for 1min | | | | | |
| | Isolation Resistance | | More than 100MΩ Output - FG : 500VDC More than 10MΩ Output -CNT : 100VDC at 25°C and 70%RH | | | | | |
| Standards | Safety Standards (*15) | | Approved by UL60950-1, CSA C22.2 No.60950-1, EN60950-1, EN50178 Designed to meet DENAN | | | | | |
| | PFHC | | Designed to meet IEC61000-3-2 | | | | | |
| | EMI | | Designed to meet EN55011/EN55022-B, FCC-B, VCCI-B | | | | | |
| Mechanical | Immunity | | Designed to meet IEC61000-4-2(Level 2,3), -3(Level 3), -4(Level 3), -5(Level 3,4), -6(Level 3), -8(Level 4), -11 | | | | | |
| | Weight (typ) | g | 1000 | | | | | |
| | Size (W x H x D) | mm | 61 x 82 x 165 (Refer to outline drawing) | | | | | |

- (*1) () : Peak output current at 200VAC. Operating time at peak output is less than 10sec, duty is less than 35%.
- (*2) At 100/200VAC, Ta=25°C and maximum output power.
- (*3) For cases where conformance to various safety specs (UL, CSA, EN) are required, to be described as 100 - 240VAC (50/60Hz).
- (*4) Not applicable for the in-rush current to noise filter for less than 0.2ms.
- (*5) Measure with JEITA RC-9131A probe, bandwidth of scope :100MHz.
- (*6) 85 - 265VAC, constant load.
- (*7) No load-Full load, constant input voltage.
- (*8) 3.3, 5V model: Constant current limit and hiccup with automatic recovery.
12 - 48V model: Constant current limit with automatic recovery.
Avoid to operate at over load or short circuit condition for more than 30 seconds.
- (*9) OVP circuit will shut the output down, manual reset (CNT reset or re power on).
- (*10) At 100/200VAC, nominal output voltage and maximum output current.
- (*11) Measured by the each measuring method of UL, CSA, EN and DENAN (at 60Hz), Ta=25°C.
- (*12) Ratings - Derating at standard mounting. Refer to output derating curve.
- Load (%) is percent of maximum output power or maximum output current, whichever is greater.
- (*13) For -40°C to -10°C need 3minutes to stabilize the output voltage.
- (*14) Category 4 exposure levels : Truck transportation over U.S. highways, composite two-wheeled trailer.
- (*15) As for DENAN, designed to meet at 100VAC.

● Recommended EMC Filter



RSEN-2006
Please refer to "TDK-Lambda EMC Filters" catalog.

Outline Drawing

[HWS300/HD]

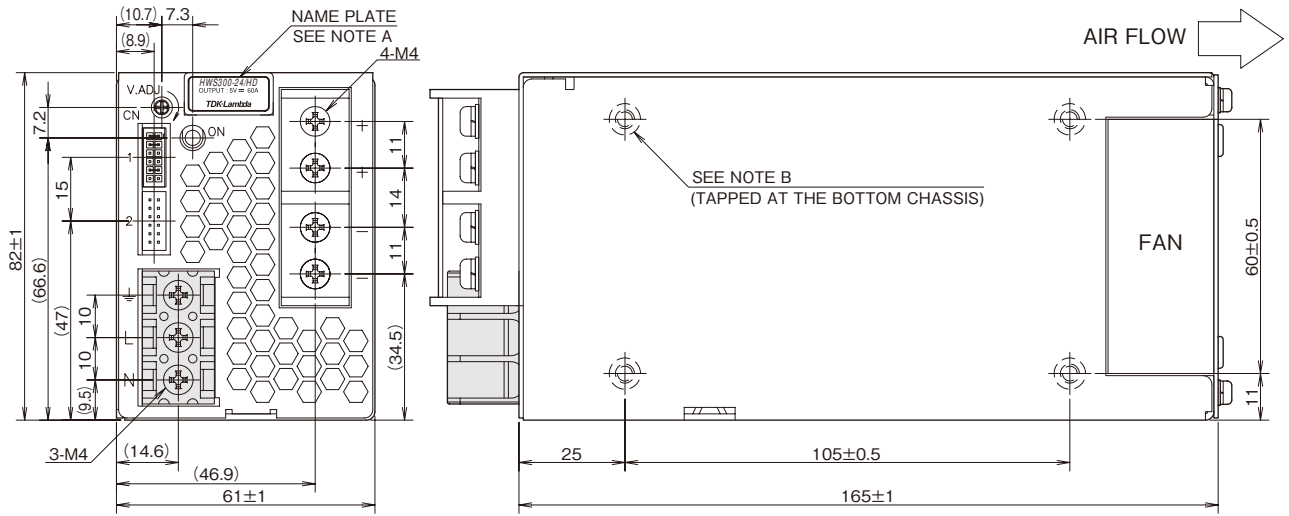

== NOTES ==

A : MODEL NAME, NOMINAL OUTPUT VOLTAGE AND MAXIMUM OUTPUT CURRENT ARE SHOWN IN THE NAME PLATE IN ACCORDANCE WITH THE SPECIFICATIONS.

B : M4 TAPPED HOLES (8) FOR CUSTOMER CHASSIS MOUNTING.(SCREW PENETRATION DEPTH 6m/m MAX.)

== ACCESSORIES ==

- * COVER FOR BARRIER TERMINAL STRIP -----1 (ATTACHED ON TERMINAL AT SHIPMENT)
- * SHORT PIECE -----1 SHORTING +Vm +S, -Vm -S, CNT TOG (ATTACHED ON CN1 AT SHIPMENT)

== SIGNAL CONNECTOR USED ==

| PART DESCRIPTION | PART NAME | MANUFACT |
|------------------|------------|----------|
| PIN HEADER | S12B-PHDSS | JST |

== MATCHING HOUSINGS , PINS & TOOL ==

| PART DESCRIPTION | PART NAME | MANUFACT |
|--------------------|--|----------|
| SOCKET HOUSING | PHDR-12VS | JST |
| TERMINAL PINS | SPHD-002T-P0.5(AWG28-24) SPHD-001T-P0.5(AWG26-22) | JST |
| HAND CRIMPING TOOL | YRS-620(SPHD-002T-P0.5) YC-610R(SPHD-001T-P0.5) | JST |

== OPTIONAL MODELS ==

| MODEL | COATING |
|-------------|---------|
| HWS300-* | — |
| HWS300-*/CO | ○ |
| HWS300-*/HD | ○ |

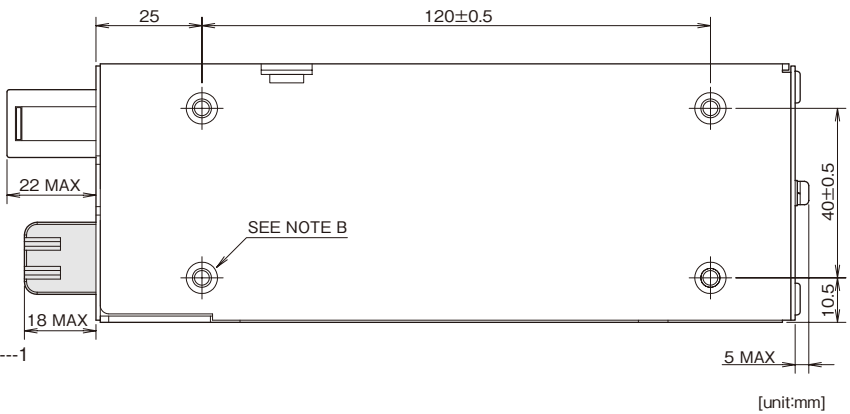

[unit:mm]

HWS/HD

OUTPUT DERATING

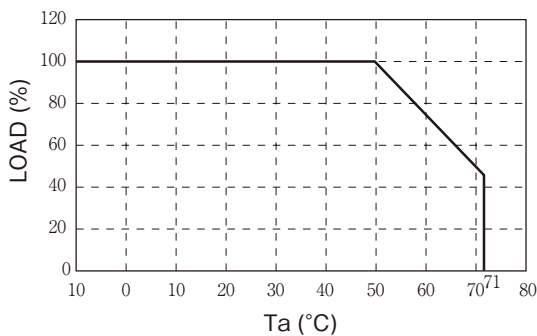

| Ta(°C) | LOAD(%) | |
|------------|------------|------------|
| | MOUNTING A | MOUNTING B |
| -10 to +50 | 100 | 100 |
| 71 | 20 | 20 |

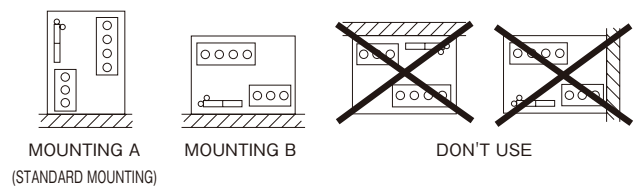

●Please refer to instruction manual. GO!! A-161

HWS600/HD Specifications

| ITEMS/UNITS | | MODEL | HWS600-3/HD | HWS600-5/HD | HWS600-12/HD | HWS600-15/HD | HWS600-24/HD | HWS600-48/HD | |
|-----------------------|---|--|--|-------------|--------------|--------------|--------------|--------------|---------|
| Input | Voltage Range (*3) | V | AC85 - 265 or DC120 - 330 | | | | | | |
| | Frequency (*3) | Hz | 47 - 63 | | | | | | |
| | Power Factor (100/200VAC)(typ) (*2) | | 0.99 / 0.95 | | | | | | |
| | Efficiency (100/200VAC)(typ) (*2) | % | 75 / 78 | 80 / 83 | | 81 / 84 | | 82 / 85 | 83 / 86 |
| | Current (100/200VAC)(typ) (*2) | A | 5.4 / 2.6 | 7.5 / 3.6 | | 8.1 / 3.9 | | | |
| | Inrush Current (100/200VAC)(typ) (*4) | A | 20 / 40 | | | | | | |
| Leakage Current (*11) | mA | Less than 0.75. (0.2 (typ) at 100VAC / 0.44 (typ) at 230VAC) | | | | | | | |
| Output | Nominal Voltage | VDC | 3.3 | 5 | 12 | 15 | 24 | 48 | |
| | Maximum Current (*1) | A | 120 | | 53 | 43 | 27 (31) | | 13 |
| | Maximum Power | W | 396 | 600 | 636 | 645 | 648 | 624 | |
| | Maximum Line Regulation (*6) | mV | 20 | | 48 | 60 | 96 | 192 | |
| | Maximum Load Regulation (*7) | mV | 30 | | 72 | 90 | 144 | 288 | |
| | Temperature Coefficient | | Less than 0.02% / °C | | | | | | |
| | Maximum Ripple & Noise (0<Ta<70°C) (*5) | mVp-p | 120 | | 150 | | 350 | | |
| | Maximum Ripple & Noise (-10<Ta< 0°C) (*5) | mVp-p | 180 | | 200 | | 400 | | |
| | Hold-up Time (typ) (*10) | ms | 20 | | | | | | |
| | Voltage Adjustable Range | VDC | 2.64-3.96 | 4.0-6.0 | 9.6-14.4 | 12.0-18.0 | 19.2-28.8 | 38.4-52.8 | |
| Function | Over Current Protection (*8) | A | >126 | | >55.7 | >45.2 | >31.4 | >13.7 | |
| | Over Voltage Protection (*9) | VDC | 4.13-4.95 | 6.25-7.25 | 15.0-17.4 | 18.8-21.8 | 30.0-34.8 | 55.2-64.8 | |
| | Remote Sensing | | Possible | | | | | | |
| | Remote ON/OFF Control | | Possible | | | | | | |
| | Parallel Operation | | Possible | | | | | | |
| | Series Operation | | Possible | | | | | | |
| | Monitoring Signal | | PF (Open Collector Output) | | | | | | |
| | Line DIP | | Designed to meet SEMI-F47 (200VAC Line only) | | | | | | |
| Environment | Operating Temperature (*12)(*13) | °C | -10 to +71 (-10 to +50: 100%, +71: 50%) Guarantee start up at -40 to -10 | | | | | | |
| | Storage Temperature | °C | -40 to +85 | | | | | | |
| | Operating Humidity | %RH | 10 - 90%RH (No dewdrop) | | | | | | |
| | Storage Humidity | %RH | 10 - 95%RH (No dewdrop) | | | | | | |
| | Vibration (*14) | | At no operating, 10 - 55Hz (sweep for 1min) 19.6m/s ² constant, X, Y, Z 1 hour each. Designed to meet MIL-STD-810F 514.5 Category 4, 10 | | | | | | |
| | Shock (In package) | | Less than 196.1m/s ² Designed to meet MIL-STD-810F 516.5 Procedure I, VI | | | | | | |
| | Cooling | | Forced air by blower fan | | | | | | |
| Isolation | Withstand Voltage | | Input - FG : 2.5kVAC (20mA), Input - Output : 3kVAC (20mA) Output - FG : 500VAC (100mA), Output - CNT : 100VAC(100mA) for 1min | | | | | | |
| | Isolation Resistance | | More than 100MΩ Output - FG : 500VDC More than 10MΩ Output - CNT : 100VDC at 25°C and 70%RH | | | | | | |
| Standards | Safety Standards (*15) | | Approved by UL60950-1, CSA C22.2 No 60950-1, EN60950-1, EN50178 Designed to meet DENAN | | | | | | |
| | PFHC | | Designed to meet IEC61000-3-2 | | | | | | |
| | EMI | | Designed to meet EN55011/EN55022-B, FCC-B, VCCI-B | | | | | | |
| | Immunity | | Designed to meet IEC61000-4-2(Level 2,3), -3(Level 3), -4(Level 3), -5(Level 3,4), -6(Level 3), -8(Level 4), -11 | | | | | | |
| Mechanical | Weight (typ) | g | 1600 | | | | | | |
| | Size (W x H x D) | mm | 100 x 82 x 165 (Refer to outline drawing) | | | | | | |

(*1) () : Peak output current at 200VAC. Operating time at peak output is less than 10sec, duty is less than 35%.

(*2) At 100/200VAC, Ta=25°C and maximum output power.

(*3) For cases where conformance to various safety specs (UL, CSA, EN) are required, to be described as 100 - 240VAC (50/60Hz).

(*4) Not applicable for the in-rush current to noise filter for less than 0.2ms. Inrush Current is 30A (typ) when PFHC start-up.

(*5) Measure with JEITA RC-9131A probe, bandwidth of scope : 100MHz.

(*6) 85 - 265VAC, constant load.

(*7) No load - Full load, constant input voltage.

(*8) 3V and 5V model: Constant current limit and hiccup with automatic recovery.

12 - 48V model: Constant current limit with automatic recovery. Avoid to operate at over load or short circuit condition for more than 30 seconds.

(*9) OVP circuit will shut the output down, manual reset (CNT reset or Re-power on).

(*10) At 100/200VAC, nominal output voltage and maximum output current.

(*11) Measured by the each measuring method of UL, CSA, EN and DENAN (at 60Hz), Ta=25°C.

(*12) Ratings - Derating at standard mounting. Refer to output derating curve.

- Load (%) is percent of maximum output power or maximum output current, whichever is greater.

(*13) For -40°C to -10°C need 3 minutes to stabilize the output voltage.

(*14) Category 4 exposure levels : Truck transportation over U.S. highways, composite two-wheeled trailer.

(*15) As for DENAN, designed to meet at 100VAC.

● Recommended EMC Filter



RSEN-2016

Please refer to "TDK-Lambda EMC Filters" catalog.

Outline Drawing

[HWS600/HD]

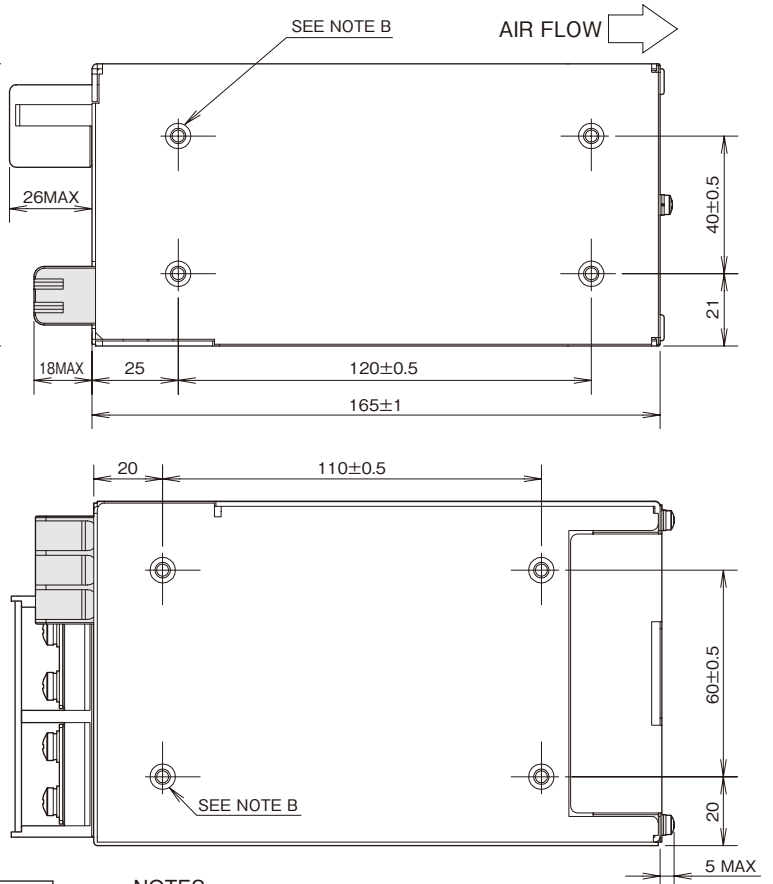
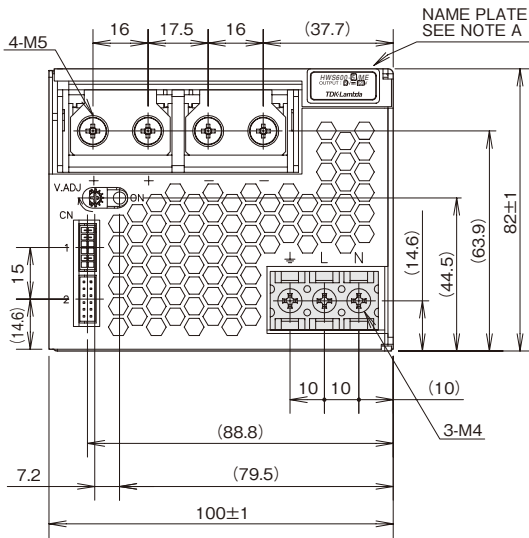

HWS /HD

== OPTIONAL MODELS ==

| MODEL | COATING |
|-------------|---------|
| HWS600-* | --- |
| HWS600-*/CO | ○ |
| HWS600-*/HD | ○ |

== SIGNAL CONNECTOR USED ==

| PART DESCRIPTION | PART NAME | MANUFACT |
|------------------|------------|----------|
| PIN HEADER | S12B-PHDSS | JST |

== MATCHING HOUSINGS, PINS & TOOL ==

| PART DESCRIPTION | PART NAME | MANUFACT |
|--------------------|--|----------|
| SOCKET HOUSING | PHDR-12VS | JST |
| TERMINAL PINS | SPHD-002T-P0.5(AWG28~24) SPHD-001T-P0.5(AWG26~22) | JST |
| HAND CRIMPING TOOL | YRS-620(SPHD-002T-P0.5) YC-610R(SPHD-001T-P0.5) | JST |

== NOTES ==

- A: MODEL NAME, NOMINAL OUTPUT VOLTAGE AND MAXIMUM OUTPUT CURRENT ARE SHOWN IN THE NAME PLATE IN ACCORDANCE WITH THE SPECIFICATIONS. [unit:mm]
- B: M4 TAPPED HOLES (8) FOR CUSTOMER CHASSIS MOUNTING. (SCREW PENETRATION DEPTH 6mm MAX.)

== ACCESSORIES ==

- * COVER FOR BARRIER TERMINAL STRIP -----1 (ATTACHED ON TERMINAL AT SHIPMENT)
- * SHORT PIECE -----1 SHORTING +Vm - +S, -Vm - -S, CNT TOG (ATTACHED ON CN1 AT SHIPMENT)

Derating Curve

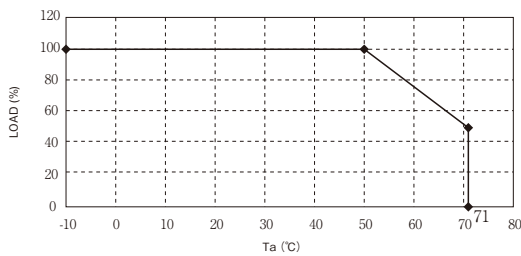

| Ta (°C) | LOAD (%) | |
|------------|------------|------------|
| | MOUNTING A | MOUNTING B |
| -10 to +50 | 100 | |
| 71 | 50 | |

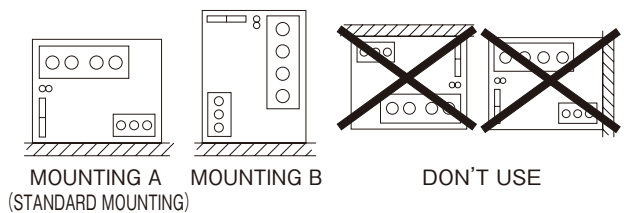

●Please refer to instruction manual. A-161

HWS1500/HD Specifications

| ITEMS/UNITS | | MODEL | HWS1500-12/HD | HWS1500-15/HD | HWS1500-24/HD | HWS1500-36/HD | HWS1500-48/HD |
|------------------------------|--|--------------------------|---|---------------|---------------|---------------|---------------|
| Input | Voltage Range (*2) | V | AC85 - 265 | | | | |
| | Frequency (*2) | Hz | 47 - 63 | | | | |
| | Power Factor (100/230VAC)(typ) (*1) | | 0.98 / 0.94 | | | | |
| | Efficiency (100/200VAC)(typ) (*1) | % | 82 / 85 | 83 / 87 | 84 / 88 | | 86 / 90 |
| | Current (100/200VAC)(typ) (*1) | A | 19.0 / 10.0 | | | | |
| | Inrush Current (100/200VAC)(typ) (*3) | A | 20 / 40 | | | | |
| | Leakage Current (100/240VAC) (*10) | mA | 1.5 max | | | | |
| Output | Nominal Voltage | V | 12 | 15 | 24 | 36 | 48 |
| | Maximum Current (100/200VAC) | A | 125 / 125 | 100 / 100 | 65 / 70 | 42 / 46.5 | 32 / 32 |
| | Maximum Peak Current (200VAC) (*13) | A | - | | | | |
| | Maximum Power (100VAC) | W | 1500 | | 1560 | 1512 | 1536 |
| | Maximum Power (200VAC) | W | 1500 | | 1680 | 1674 | 1536 |
| | Maximum Peak Power (200VAC) (*13) | W | - | | 2520 | | - |
| | Maximum Line Regulation (*5) | mV | 48 | 60 | 96 | 144 | 192 |
| | Maximum Load Regulation (*6) | mV | 72 | 90 | 144 | 150 | 288 |
| | Temperature Coefficient | | Less than 0.02%/°C | | | | |
| | Maximum Ripple & Noise (0 to +71°C) (*4) | mVp-p | 150 | | 200 | | |
| | Maximum Ripple & Noise (-10 to 0°C) (*4) | amVp-p | 200 | | | 240 | 400 |
| | Hold-up Time (typ) (*9) | ms | 20 | | | | |
| | Function | Voltage Adjustable Range | VDC | 9.6 - 14.4 | 12.0 - 18.0 | 19.2 - 28.8 | 28.8 - 43.2 |
| Over Current Protection (*7) | | | >105% | | | | |
| Over Voltage Protection (*8) | | V | 15.0 - 17.4 | 18.7 - 21.8 | 30.0 - 34.8 | 45.0 - 49.7 | 55.2 - 64.8 |
| Remote Sensing | | | Possible | | | | |
| Remote ON/OFF Control | | | Possible | | | | |
| Parallel Operation | | | Possible | | | | |
| Series Operation | | | Possible | | | | |
| Monitoring Signal | | | PF (Open collector output) | | | | |
| Line DIP | | | Designed to meet SEMI-F47 (200VAC Line only) | | | | |
| Other Function | | | PCB Coating on solder side and component side. | | | | |
| Environment | Operating Temperature (*11) | °C | -10 to +71 (-10 to +50: 100%, +60: 75%, +71: 50%), Guarantee start up at -40 to -10 | | | | |
| | Storage Temperature | °C | -40 to +85 | | | | |
| | Operating Humidity | %RH | 10 - 90 (No dewdrop) | | | | |
| | Storage Humidity | %RH | 10 - 95 (No dewdrop) | | | | |
| | Vibration (*14) | | At no operating, 10 - 55Hz (sweep for 1min.) 19.6m/s ² constant, X,Y,Z 1h each. Designed to meet MIL-STD-810F 514.5 Category4 figure 514.5C-1 | | | | |
| | Shock (In package) | | Less than 196.1m/s ² | | | | |
| Isolation | Withstand Voltage | | Input - FG : 2kVAC (20mA), Input - Output : 3kVAC (20mA) Output-FG : 500VAC (300mA), Output-CNT:100VAC (100mA) for 1min. | | | | |
| | Isolation Resistance | | More than 100Mohm Output - FG ... 500VDC More than 10Mohm Output - CNT ... 100VDC at 25°C and 70%RH | | | | |
| | Safety Standards (*12) | | Built to meet UL60950-1, CSA C22.2 NO,60950-1, EN60950-1, EN50178. Designed to meet DENAN. | | | | |
| Standards | PFHC | | Designed to meet IEC61000-3-2 | | | | |
| | EMI | | Designed to meet EN55011/EN55022-A, FCC-ClassA, VCCI-ClassA. | | | | |
| | Immunity | | Designed to meet IEC61000-4-2(Level 2,3), -3(Level 3), -4(Level 3), -5(Level 3,4), -6(Level 3), -8(Level 4), -11 | | | | |
| Mechanical | Weight (typ) | g | 3800 | | | | |
| | Size (W x H x D) | mm | 126.5 x 82 x 280 (Refer to outline drawing) | | | | |

HWS
/HD

- (*1) At Ta=25°C and maximum output power.
- (*2) For cases where conformance to various safety specs (UL, CSA, EN) are required, input voltage range will be 100 - 240VAC (50/60Hz).
- (*3) First in-rush current. Not applicable for the in-rush current to noise filter less than 0.2ms.
- (*4) Measure with JEITA RC-9131A probe, bandwidth of scope :100MHz. (at 22uF electric capacitor and 0.47uF film capacitor on the test fixture board.)
- (*5) 85 - 265VAC , constant load.
- (*6) No load-full load, constant input voltage.
- (*7) Constant current limit with automatic recovery. An output will be intercepted if it continues for about 5 seconds.
- (*8) OVP circuit will shut down output, manual reset (power cycle) or ON/OFF CNT signal reset.
- (*9) At 100/200VAC, nominal output voltage and maximum output current.
- (*10) Measured by the each measuring method of UL, CSA, EN and DENAN (at 60Hz), Ta=25°C.
- (*11) Ratings - Derating at standard mounting.
 - Load (%) is percent of maximum output power or maximum output current, whichever is greater.
 - As for other mountings, refer to derating curve.
 - For conditions of start up at -40°C to -10°C, refer to derating curve.
- (*12) As for DENAN, designed to meet at 100VAC.
- (*13) Peak output current is less than 10 seconds, and duty 35% max.
- (*14) Category 4 exposure levels : Track transportation over U.S. highways.

● Recommended EMC Filter



RSEN-2030
Please refer to "TDK-Lambda EMC Filters" catalog.

Outline Drawing

[HWS1500/HD]

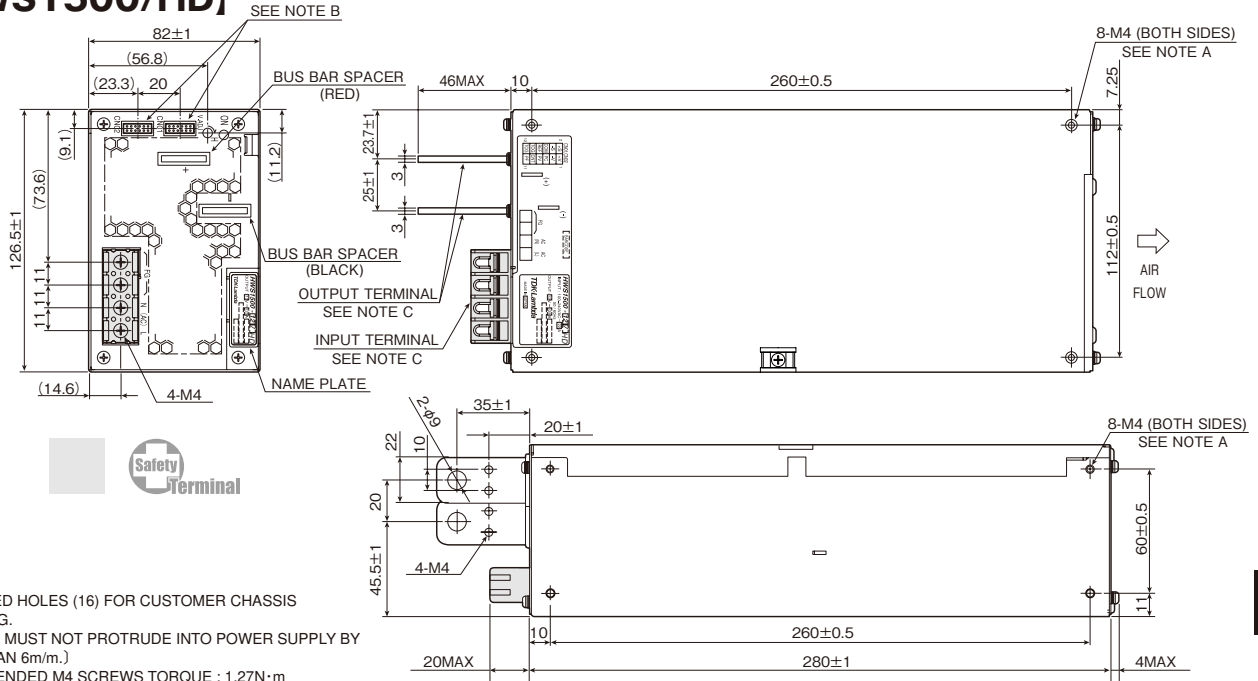

NOTES

A: M4 TAPPED HOLES (16) FOR CUSTOMER CHASSIS MOUNTING.
(SCREWS MUST NOT PROTRUDE INTO POWER SUPPLY BY MORE THAN 6m/m.)
RECOMMENDED M4 SCREWS TORQUE : 1.27N·m

B: I/O SIGNAL CONNECTOR

| | | |
|--------------------|----------------------------|----------|
| CONNECTOR | : S12B-PHDSS(LF)(SN) | (JST) |
| MATCHING HOUSING | : PHDR-12VS | (JST) |
| MATCHING CONTACT | : SPHD-002T-P0.5(AWG28~24) | (JST) OR |
| | : SPHD-001T-P0.5(AWG26~22) | (JST) OR |
| | : BPHD-001T-P0.5(AWG26~22) | (JST) |
| HAND CRIMPING TOOL | : YRS-620(SPHD-002T-P0.5) | (JST) |
| | : YC-610R(SPHD-001T-P0.5) | (JST) |
| | : YC-610R(BPHD-001T-P0.5) | (JST) |

ACCESSORIES

* ATTACHED CONNECTOR
SHORTING +S~+V, -S~-V, PV~REF & CNT~TOG
ATTACHED ON CN01 AT SHIPMENT

C: RECOMMENDED TORQUE FOR THE TERMINAL PIECE.
INPUT TERMINAL (M4 SCREW) : 1.27N·m
OUTPUT TERMINAL (M8 BOLT & NUT) : 10.8N·m
OUTPUT TERMINAL (M4 SCREW) : 1.27N·m

[Unit : mm]

OUTPUT DERATING

| Ta(°C) | LOAD(%) | |
|------------|---------------------|------|
| | MOUNTING A, B, C, D | |
| | 85V | >90V |
| -10 to +50 | 80 | 100 |
| 60 | 60 | 75 |
| 71 | 40 | 50 |

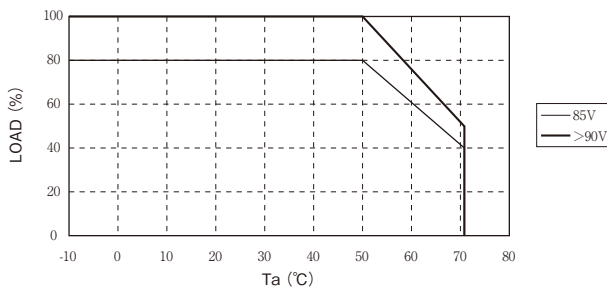

| Ta(°C) | LOAD(%) | |
|------------|---------------------|------|
| | MOUNTING A, B, C, D | |
| | 85V | >90V |
| -40 to -20 | 40 | 40 |
| -20 | 80 | 100 |
| -10 | 80 | 100 |

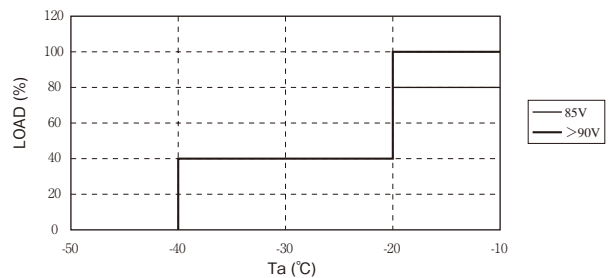

=NOTES=

- Input voltage: Not gradual start up.
- No drodrop.
- Output voltage becomes more stable by performing the following.
 - Electrolytic capacitor is added to an output.
 +12V : LXZ 25V 2700uF (NIPPON CHEMI-CON) x3 parallel
 +15V : LXZ 25V 2700uF (NIPPON CHEMI-CON) x3 parallel
 +24V : LXZ 35V 1800uF (NIPPON CHEMI-CON) x3 parallel
 +36V : LXZ 50V 1000uF (NIPPON CHEMI-CON) x3 parallel
 +48V : LXZ 63V 8200uF (NIPPON CHEMI-CON) x3 parallel
 - Remote sensing function is used.
 Connect "+S" terminal to "+" terminal of the electrolytic capacitor and "-S" terminal to "-" terminal of the electrolytic capacitor with sensing wires.
- Pay attention to above items before using the unit. Incorrect usage could lead to unstable output voltage.

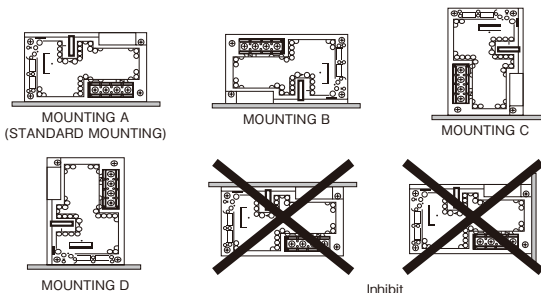

●Please refer to instruction manual. A-169

TDK-Lambda

HWS/ME SERIES

Single Output 30W-1500W

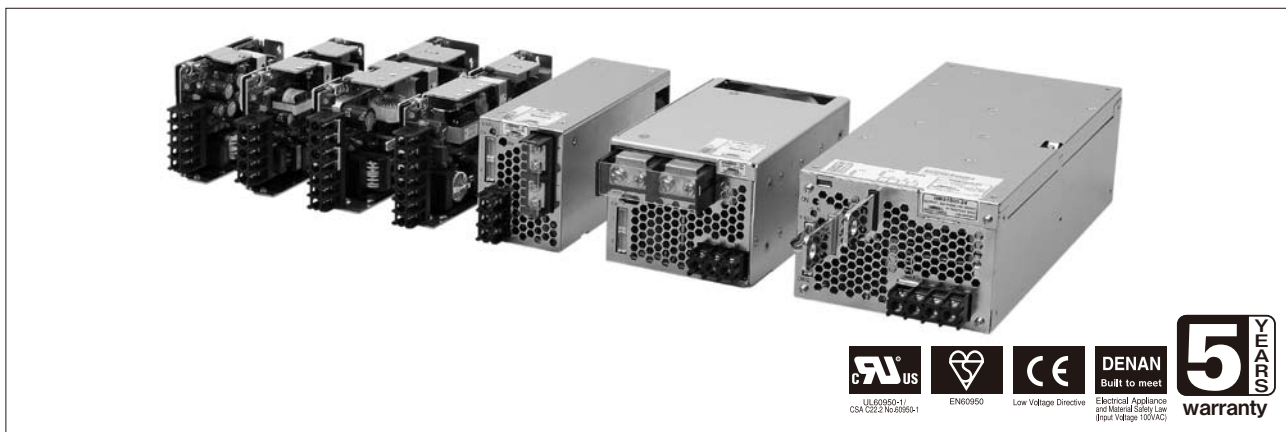

■ Features

- AC-DC switching power supply for medical equipment.
 - Approval UL60601-1 (see note)
 - Approval EN60601-1 (see note)
 - Approval CSA C22.2 No.601.1-M90 (see note)
- Environmentally-friendly: Conforming to RoHS directives
High-efficiency technology reduces power loss by heat generation. Fan stopping in power-off by external control realizes silence and energy saving.
- Easy to use: All models in the same height of 82mm. Mountable in 2U-height racks without dead space.
- Safety and reliability: "Safety terminal" covering current flowing part secures safety for users. "No screw-dropping" design prevents from losing screws during maintenance operation.
- HWS1500-48 realizes as high efficiency as 90%.
Synchronous rectifier circuit improved efficiency of low voltage models by over 10% (HWS150-5).

■ Model naming method

[HWS30-150]
HWS 50 – 5 / ME
Series name Output power
 ME: Without cover, approved by safety standards for medical equipment
 Nominal output voltage
 ex. 3: 3.3V, 5: 5V, 48: 48V

[HWS300-1500]
HWS 300 – 5 / ME
Series name Output power
 ME: With cover and forced air cooling by built-in fan, approved safety standards for medical equipment (except for HWS1000)
 Nominal output voltage
 ex. 3: 3.3V, 5: 5V, 48: 48V

HWS/ME

■ Applications



MED

■ Product Line up

| Output Voltage | 30W | | 50W | | 100W | | 150W | |
|----------------|----------------|-------------|----------------|-------------|----------------|--------------|----------------|--------------|
| | Output Current | Model | Output Current | Model | Output Current | Model | Output Current | Model |
| 5V | 6A | HWS30-5/ME | 10A | HWS50-5/ME | 20A | HWS100-5/ME | 30A | HWS150-5/ME |
| 12V | 2.5A | HWS30-12/ME | 4.3A | HWS50-12/ME | 8.5A | HWS100-12/ME | 13A | HWS150-12/ME |
| 15V | 2A | HWS30-15/ME | 3.5A | HWS50-15/ME | 7A | HWS100-15/ME | 10A | HWS150-15/ME |
| 24V | 1.3A | HWS30-24/ME | 2.2A | HWS50-24/ME | 4.5A | HWS100-24/ME | 6.5A | HWS150-24/ME |
| 48V | 0.65A | HWS30-48/ME | 1.1A | HWS50-48/ME | 2.1 | HWS100-48/ME | 3.3A | HWS150-48/ME |

| Output Voltage | 300W | | 600W | | 1500W | |
|----------------|----------------|--------------|-----------------------|--------------|--------------------------------------|---------------|
| | Output Current | Model | Output Current (Peak) | Model | Output Current ^(*) (Peak) | Model |
| 5V | — | — | — | — | — | — |
| 12V | 27A | HWS300-12/ME | — | — | — | — |
| 15V | 22A | HWS300-15/ME | — | — | — | — |
| 24V | 14A (16.5A) | HWS300-24/ME | 27A (31A) | HWS600-24/ME | 65A/70A (105A) | HWS1500-24/ME |
| 36V | — | — | — | — | 42A/46.5A (70A) | HWS1500-36/ME |
| 48V | 7A | HWS300-48/ME | — | — | 32A/32A (—) | HWS1500-48/ME |

(Note) The following conditions are required.

- Please use the insulating material for the equipment chassis when the power supply is used in the equipment near patients.
 - Approved with the basic insulation, an additional insulation circuit is required outside of the power supply.
- (*) (100Vin/200Vin)

HWS30/ME Specifications

| ITEMS/UNITS | | MODEL | HWS30-5/ME | HWS30-12/ME | HWS30-15/ME | HWS30-24/ME | HWS30-48/ME |
|-------------|---|-------|---|-------------|-------------|-------------|-------------|
| Input | Voltage Range (*2) | V | AC85 - 265 or DC120 - 370 | | | | |
| | Frequency (*2) | Hz | 47 - 63 | | | | |
| | Efficiency (100/200VAC)(typ) (*1) | % | 77 / 80 | 81 / 83 | | 83 / 86 | 82 / 83 |
| | Current (100/200VAC)(typ) (*1) | A | 0.8 / 0.4 | | | | |
| | Inrush Current (100/200VAC)(typ) (*3) | A | 14 / 28 at Ta=25°C, cold start | | | | |
| | Leakage Current (*10) | mA | Less than 0.5. (0.2 (typ) at 100VAC / 0.4 (typ) at 230VAC) | | | | |
| Output | Nominal Voltage | VDC | 5 | 12 | 15 | 24 | 48 |
| | Maximum Current | A | 6 | 2.5 | 2 | 1.3 | 0.65 |
| | Maximum Power | W | 30 | | | | 31.2 |
| | Maximum Line Regulation (*5) | mV | 20 | 48 | 60 | 96 | 192 |
| | Maximum Load Regulation (*6) | mV | 40 | 96 | 120 | 192 | 384 |
| | Temperature Coefficient | | Less than 0.02% / °C | | | | |
| | Maximum Ripple & Noise (0≤Ta≤70°C) (*4) | mVp-p | 120 | 150 | | 200 | |
| | Maximum Ripple & Noise (-10≤Ta< 0°C) (*4) | mVp-p | 160 | 180 | | 240 | |
| | Hold-up Time (typ) (*9) | ms | 20 | | | | |
| | Voltage Adjustable Range | VDC | 4.0 - 6.0 | 9.6 - 14.4 | 12.0 - 18.0 | 19.2 - 28.8 | 38.4 - 52.8 |
| Function | Over Current Protection (*7) | A | >6.3 | >2.62 | >2.1 | >1.36 | >0.68 |
| | Over Voltage Protection (*8) | VDC | 6.25 - 7.25 | 15.0 - 17.4 | 18.8 - 21.8 | 30.0 - 34.8 | 55.2 - 64.8 |
| | Remote Sensing | | - | | | | |
| | Parallel Operation | | - | | | | |
| | Series Operation | | Possible | | | | |
| | Line DIP | | Designed to meet SEMI-F47 (200VAC Line only) | | | | |
| Environment | Operating Temperature (*11) | °C | -10 to +70 (-10 to +50: 100%, +60: 60%, +70: 20%) | | | | |
| | Storage Temperature | °C | -30 to +85 | | | | |
| | Operating Humidity | %RH | 30 - 90 (No dewdrop) | | | | |
| | Storage Humidity | %RH | 10 - 95 (No dewdrop) | | | | |
| | Vibration | | At no operating, 10 - 55Hz (sweep for 1min) 19.6m/s ² constant, X, Y, Z 1hour each. | | | | |
| | Shock (In package) | | Less than 196.1m/s ² | | | | |
| | Cooling | | Convection cooling | | | | |
| Isolation | Withstand Voltage | | Input - FG : 2kVAC (20mA), Input - Output : 3kVAC (20mA) Output - FG : 500VAC (100mA) for 1min | | | | |
| | Isolation Resistance | | More than 100MΩ at 25°C and 70%RH Output - FG : 500VDC | | | | |
| Standards | Safety Standards (*12) | | Approved by UL60601-1, EN60601-1, CSA-C22.2 No.601.1-M90 | | | | |
| | PFHC | | Designed to meet IEC61000-3-2 | | | | |
| | Voltage Fluctuations / Flicker Emissions | | Designed to meet IEC61000-3-3 | | | | |
| | EMI | | Designed to meet EN55011/EN55022-B, FCC-B, VCCI-B | | | | |
| Mechanical | Immunity | | Designed to meet IEC61000-4-2(Level 3), -3(Level 3), -4(Level 3), -5(Level 3,4), -6(Level 3), -8(Level 4), -11 | | | | |
| | Weight (typ) | g | 220 | | | | |
| | Size (W x H x D) | mm | 26.5 x 82 x 95 (Refer to outline drawing) | | | | |

(*1) At 100/200VAC, Ta=25°C and maximum output power.

(*2) For cases where conformance to various safety specs (UL, EN, CSA) are required, to be described as 100 - 230VAC (50/60Hz).

(*3) Not applicable for the in-rush current to noise filter for less than 0.2ms.

(*4) Measure with JEITA RC-9131A probe, bandwidth of scope:100MHz.
For start up at low ambient temperature and low input voltage, output ripple noise might not meet specification.
However, there is no overshoot at start up and output ripple noise specification can be met after one second.

(*5) 85 - 265VAC, constant load.

(*6) No load-full load, constant input voltage.

(*7) Foldback current limit with automatic recovery. Not operate at over load or dead short condition for more than 30 seconds.

(*8) OVP circuit will shutdown output, manual reset (re power on).

(*9) At 100/200VAC, nominal output voltage and maximum output current.

(*10) Measured by the each measuring method of UL, EN and CSA (at 60Hz). When using it as a patient care equipment, all outer surfaces of the equipment shall be constructed of nonconductive material. See clause 19.5DV.2 of UL60601-1.

(*11) Ratings - Derating at standard mounting.
- Load (%) is percent of maximum output power or maximum output current, whichever is greater.
- As for other mountings, refer to derating curve.

(*12) As for UL60601-1, EN60601-1 and CSA-C22.2 No.601.1-M90, basic insulation.

● Recommended EMC Filter

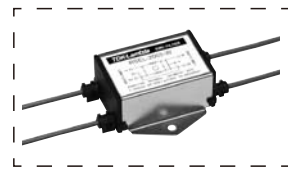

RSEL-2001 WL
Please refer to "TDK-Lambda EMC Filters" catalog.

Outline Drawing

[HWS30/ME]

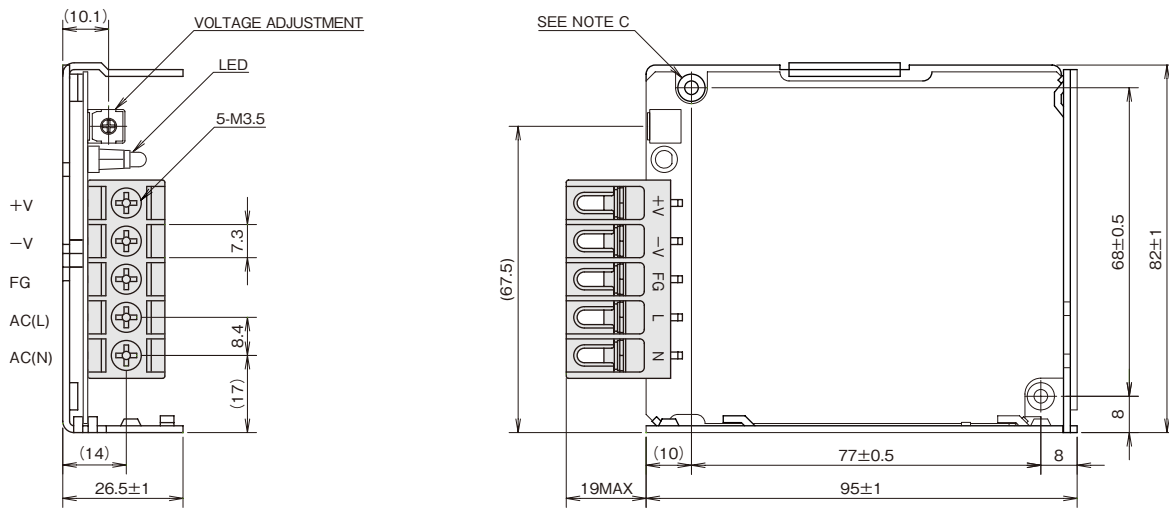

NOTES

- A : MODEL NAME, INPUT VOLTAGE RANGE, NOMINAL OUTPUT VOLTAGE, MAXIMUM OUTPUT CURRENT AND COUNTRY OF MANUFACTURE ARE SHOWN HERE IN ACCORDANCE WITH THE SPECIFICATIONS.
- B : M3 EMBOSSED, TAPPED AND COUNTERSUNK HOLES (2) FOR CUSTOMER CHASSIS MOUNTING. SCREWS MUST NOT PROTRUDE INTO POWER SUPPLY BY MORE THAN 6m/m.
- C : M3 TAPPED HOLES (2) FOR CUSTOMER CHASSIS MOUNTING. SCREWS MUST NOT PROTRUDE INTO POWER SUPPLY BY MORE THAN 6m/m.

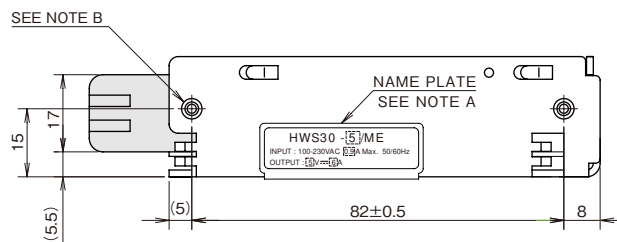

HWS /ME

Derating Curve

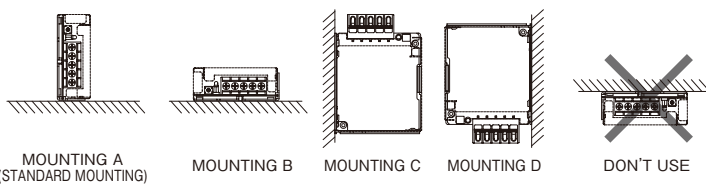
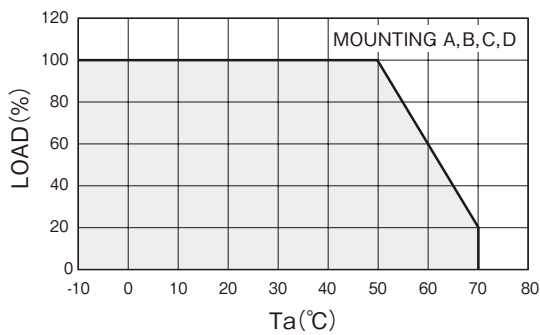

●Please refer to instruction manual. A-155

HWS50/ME Specifications

| ITEMS/UNITS | | MODEL | HWS50-5/ME | HWS50-12/ME | HWS50-15/ME | HWS50-24/ME | HWS50-48/ME |
|----------------------|---|-------------------|---|---|-------------|-------------|-------------|
| Input | Voltage Range (*2) | V | AC85 - 265 or DC120 - 370 | | | | |
| | Frequency (*2) | Hz | 47 - 63 | | | | |
| | Power Factor (100/200VAC)(typ) (*1) | | 0.99 / 0.95 | | | | |
| | Efficiency (100/200VAC)(typ) (*1) | % | 82 / 84 | 81 / 83 | | 82 / 84 | 83 / 85 |
| | Current (100/200VAC)(typ) (*1) | A | 0.7 / 0.35 | | | | |
| | Inrush Current (100/200VAC)(typ) (*3) | A | 14/28at, Ta=25°C, cold start | | | | |
| | Leakage Current (*10) | mA | Less than 0.5. (0.2 (typ) at 100VAC / 0.4 (typ) at 230VAC) | | | | |
| Output | Nominal Voltage | VDC | 5 | 12 | 15 | 24 | 48 |
| | Maximum Current | A | 10 | 4.3 | 3.5 | 2.2 | 1.1 |
| | Maximum Power | W | 50 | 51.6 | 52.5 | 52.8 | |
| | Maximum Line Regulation (*5) | mV | 20 | 48 | 60 | 96 | 192 |
| | Maximum Load Regulation (*6) | mV | 40 | 96 | 120 | 192 | 384 |
| | Temperature Coefficient | | Less than 0.02% / °C | | | | |
| | Maximum Ripple & Noise (0≤Ta≤70°C) (*4) | mVp-p | 120 | 150 | | 200 | |
| | Maximum Ripple & Noise (-10≤Ta< 0°C) (*4) | mVp-p | 160 | 180 | | 240 | |
| | Hold-up Time (typ) (*9) | ms | 20 | | | | |
| | Voltage Adjustable Range | VDC | 4.0 - 6.0 | 9.6 - 14.4 | 12.0 - 18.0 | 19.2 - 28.8 | 38.4 - 52.8 |
| Function | Over Current Protection (*7) | A | >10.5 | >4.51 | >3.67 | >2.31 | >1.15 |
| | Over Voltage Protection (*8) | VDC | 6.25 - 7.25 | 15.0 - 17.4 | 18.8 - 21.8 | 30.0 - 34.8 | 55.2 - 64.8 |
| | Remote Sensing | | - | | | | |
| | Parallel Operation | | - | | | | |
| | Series Operation | | Possible | | | | |
| | Line DIP | | Designed to meet SEMI-F47 (200VAC Line only) | | | | |
| | Operating Temperature (*11) | °C | -10 to +70 (-10 to +50: 100%, +60: 60%, +70: 20%) | | | | |
| Environment | Storage Temperature | °C | -30 to +85 | | | | |
| | Operating Humidity | %RH | 30 - 90 (No dewdrop) | | | | |
| | Storage Humidity | %RH | 10 - 95 (No dewdrop) | | | | |
| | Vibration | | At no operating, 10 - 55Hz (sweep for 1min) 19.6m/s ² constant, X, Y, Z 1hour each. | | | | |
| | Shock (In package) | | Less than 196.1m/s ² | | | | |
| | Cooling | | Convection cooling | | | | |
| | Isolation | Withstand Voltage | | Input - FG : 2kVAC (20mA), Input - Output : 3kVAC (20mA) Output - FG : 500VAC (100mA) for 1min | | | |
| Isolation Resistance | | | More than 100MΩ at 25°C and 70%RH Output - FG : 500VDC | | | | |
| Standards | Safety Standards (*12) | | Approved by UL60601-1, EN60601-1, CSA-C22.2 No.601.1-M90 | | | | |
| | PFHC | | Designed to meet IEC61000-3-2 | | | | |
| | Voltage Fluctuations / Flicker Emissions | | Designed to meet IEC61000-3-3 | | | | |
| | EMI | | Designed to meet EN55011/EN55022-B, FCC-B, VCCI-B | | | | |
| Mechanical | Immunity | | Designed to meet IEC61000-4-2(Level 3), -3(Level 3), -4(Level 3), -5(Level 3,4), -6(Level 3), -8(Level 4), -11 | | | | |
| | Weight (typ) | g | 280 | | | | |
| | Size (W x H x D) | mm | 26.5 x 82 x 120 (Refer to outline drawing) | | | | |

(*1) At 100/200VAC, Ta=25°C and maximum output power.

(*2) For cases where conformance to various safety specs (UL, EN, CSA) are required, to be described as 100 - 230VAC (50/60Hz).

(*3) Not applicable for the in-rush current to noise filter for less than 0.2ms.

(*4) Measure with JEITA RC-9131A probe, bandwidth of scope: 100MHz.

(*5) 85 - 265VAC, constant load.

(*6) No load-full load, constant input voltage.

(*7) Constant current limit and Hiccup with automatic recovery.
Not operate at over load or dead short condition for more than 30 seconds.

(*8) OVP circuit will shutdown output, manual reset (re power on).

(*9) At 100/200VAC, nominal output voltage and maximum output current.

(*10) Measured by the each measuring method of UL, EN and CSA (at 60Hz).
When using it as a patient care equipment, all outer surfaces of the equipment shall be constructed of nonconductive material. See clause 19.5DV.2 of UL60601-1.

(*11) Ratings - Derating at standard mounting.
- Load (%) is percent of maximum output power or maximum output current, whichever is greater.
- As for other mountings, refer to derating curve.

(*12) As for UL60601-1, EN60601-1 and CSA-C22.2 No.601.1-M90, basic insulation.

● Recommended EMC Filter



RSEL-2001 WL

Please refer to "TDK-Lambda EMC Filters" catalog.

Outline Drawing

[HWS50/ME]

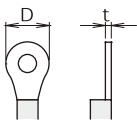
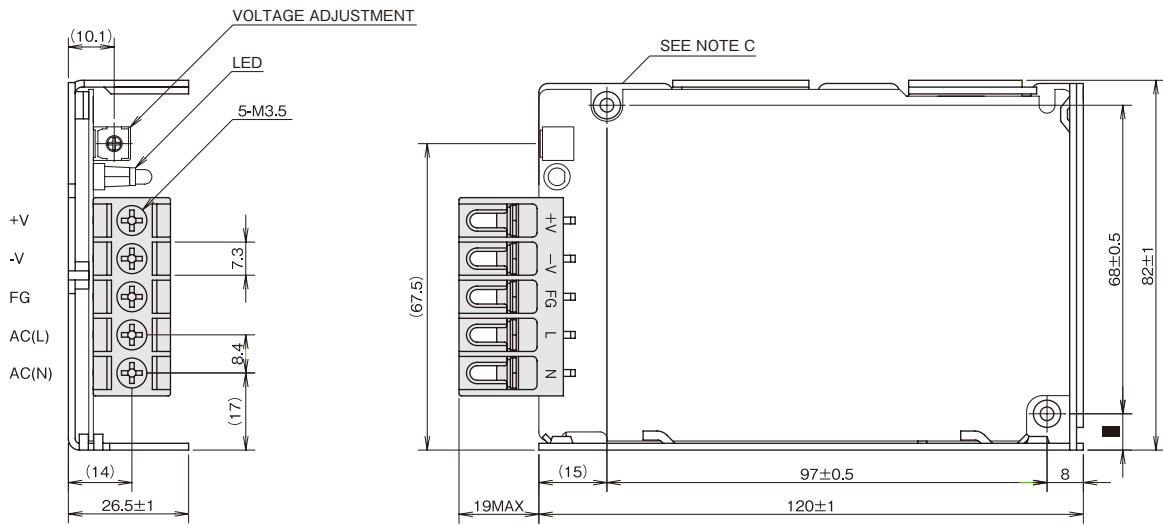

| Recommended Solderless Terminal | | |
|---------------------------------|---------|-----------|
| D (max) | t (max) | Qty (max) |
| 6.8mm | 0.8mm | 2 pcs |

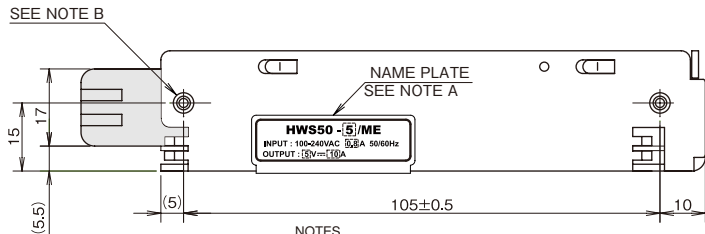

- NOTES
- A : MODEL NAME, INPUT VOLTAGE RANGE, NOMINAL OUTPUT VOLTAGE, MAXIMUM OUTPUT CURRENT AND COUNTRY OF MANUFACTURE ARE SHOWN HERE IN ACCORDANCE WITH THE SPECIFICATIONS.
 - B : M3 EMBOSSED, TAPPED AND COUNTERSUNK HOLES (2) FOR CUSTOMER CHASSIS MOUNTING. SCREWS MUST NOT PROTRUDE INTO POWER SUPPLY BY MORE THAN 6mm.
 - C : M3 TAPPED HOLES (2) FOR CUSTOMER CHASSIS MOUNTING. SCREWS MUST NOT PROTRUDE INTO POWER SUPPLY BY MORE THAN 6mm.

HWS /ME

OUTPUT DERATING

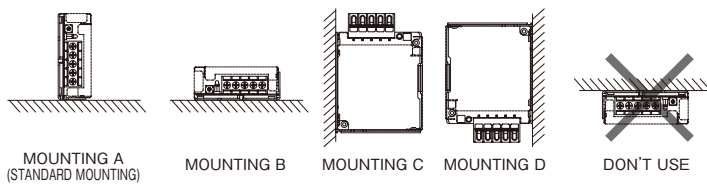
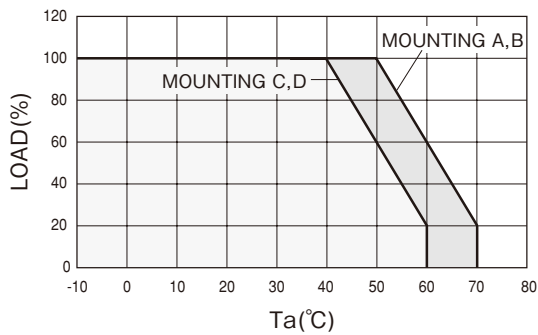

●Please refer to instruction manual. A-155

HWS100/ME Specifications

| ITEMS/UNITS | | MODEL | HWS100-5/ME | HWS100-12/ME | HWS100-15/ME | HWS100-24/ME | HWS100-48/ME |
|----------------------|---|-------------------|---|---|--------------|--------------|--------------|
| Input | Voltage Range (*2) | V | AC85 - 265 or DC120 - 370 | | | | |
| | Frequency (*2) | Hz | 47 - 63 | | | | |
| | Power Factor (100/200VAC)(typ) (*1) | | 0.99 / 0.95 | | | | |
| | Efficiency (100/200VAC)(typ) (*1) | % | 83 / 86 | | 84 / 87 | | |
| | Current (100/200VAC)(typ) (*1) | A | 1.3 / 0.65 | | | | |
| | Inrush Current (100/200VAC)(typ) (*3) | A | 14/28 at, Ta=25°C, cold start | | | | |
| | Leakage Current (*10) | mA | Less than 0.5. (0.2 (typ) at 100VAC / 0.4 (typ) at 230VAC) | | | | |
| Output | Nominal Voltage | VDC | 5 | 12 | 15 | 24 | 48 |
| | Maximum Current | A | 20 | 8.5 | 7 | 4.5 | 2.1 |
| | Maximum Power | W | 100 | 102 | 105 | 108 | 100.8 |
| | Maximum Line Regulation (*5) | mV | 20 | 48 | 60 | 96 | 192 |
| | Maximum Load Regulation (*6) | mV | 40 | 96 | 120 | 192 | 384 |
| | Temperature Coefficient | | Less than 0.02% / °C | | | | |
| | Maximum Ripple & Noise (0≤Ta≤70°C) (*4) | mVp-p | 120 | 150 | | | 200 |
| | Maximum Ripple & Noise (-10≤Ta< 0°C) (*4) | mVp-p | 160 | 180 | | | 240 |
| | Hold-up Time (typ) (*9) | ms | 20 | | | | |
| | Voltage Adjustable Range | VDC | 4.0 - 6.0 | 9.6 - 14.4 | 12.0 - 18.0 | 19.2 - 28.8 | 38.4 - 52.8 |
| Function | Over Current Protection (*7) | A | >21.0 | >8.92 | >7.35 | >4.72 | >2.20 |
| | Over Voltage Protection (*8) | VDC | 6.25 - 7.25 | 15.0 - 17.4 | 18.8 - 21.8 | 30.0 - 34.8 | 55.2 - 64.8 |
| | Remote Sensing | | Possible | | | | |
| | Parallel Operation | | - | | | | |
| | Series Operation | | Possible | | | | |
| | Line DIP | | Designed to meet SEMI-F47 (200VAC Line only) | | | | |
| | Operating Temperature (*11) | °C | -10 to +70 (-10 to +50: 100%, +60: 60%, +70: 20%) | | | | |
| Environment | Storage Temperature | °C | -30 to +85 | | | | |
| | Operating Humidity | %RH | 30 - 90 (No dewdrop) | | | | |
| | Storage Humidity | %RH | 10 - 95 (No dewdrop) | | | | |
| | Vibration | | At no operating, 10 - 55Hz (sweep for 1min) 19.6m/s ² constant, X, Y, Z 1hour each. | | | | |
| | Shock (In package) | | Less than 196.1m/s ² | | | | |
| | Cooling | | Convection cooling | | | | |
| | Isolation | Withstand Voltage | | Input - FG : 2kVAC (20mA), Input - Output : 3kVAC (20mA) Output - FG : 500VAC (100mA) for 1min | | | |
| Isolation Resistance | | | More than 100MΩ at 25°C and 70%RH Output - FG : 500VDC | | | | |
| Standards | Safety Standards (*12) | | Approved by UL60601-1, EN60601-1, CSA-C22.2 No.601.1-M90 | | | | |
| | PFHC | | Designed to meet IEC61000-3-2 | | | | |
| | Voltage Fluctuations / Flicker Emissions | | Designed to meet IEC61000-3-3 | | | | |
| | EMI | | Designed to meet EN55011/EN55022-B, FCC-B, VCCI-B | | | | |
| Mechanical | Immunity | | Designed to meet IEC61000-4-2(Level 3), -3(Level 3), -4(Level 3), -5(Level 3,4), -6(Level 3), -8(Level 4), -11 | | | | |
| | Weight (typ) | g | 450 | | | | |
| | Size (W x H x D) | mm | 28 x 82 x 160 (Refer to outline drawing) | | | | |

HWS
/ME

- (*1) At 100/200VAC, Ta=25°C and maximum output power.
- (*2) For cases where conformance to various safety specs (UL, EN, CSA) are required, to be described as 100 - 230VAC (50/60Hz).
- (*3) Not applicable for the in-rush current to noise filter for less than 0.2ms.
- (*4) Measure with JEITA RC-9131A probe, bandwidth of scope: 100MHz.
- (*5) 85 - 265VAC, constant load.
- (*6) No load-full load, constant input voltage.
- (*7) Constant current limit and Hiccup with automatic recovery.
Not operate at over load or dead short condition for more than 30 seconds.
- (*8) OVP circuit will shutdown output, manual reset (re power on).
- (*9) At 100/200VAC, nominal output voltage and maximum output current.
- (*10) Measured by the each measuring method of UL, EN and CSA (at 60Hz).
When using it as a patient care equipment, all outer surfaces of the equipment shall be constructed of nonconductive material. See clause 19.5DV.2 of UL60601-1.
- (*11) Ratings - Derating at standard mounting.
- Load (%) is percent of maximum output power or maximum output current, whichever is greater.
- As for other mountings, refer to derating curve.
- (*12) As for UL60601-1, EN60601-1 and CSA-C22.2 No.601.1-M90, basic insulation.

Recommended EMC Filter

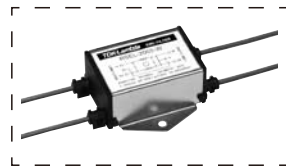

RSEL-2002WL
Please refer to "TDK-Lambda
EMC Filters" catalog.

Outline Drawing

[HWS100/ME]

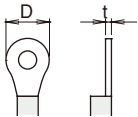
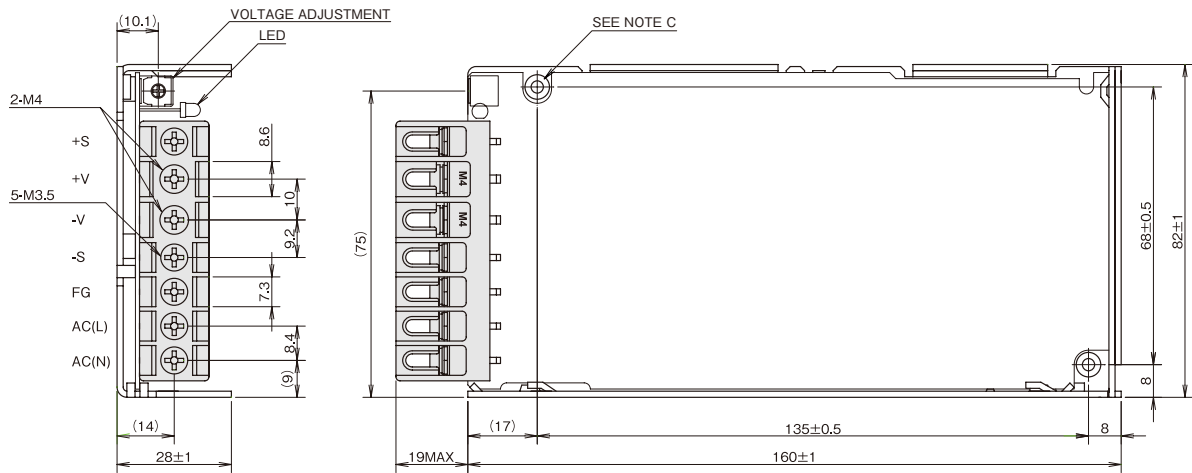

| Terminal | Recommended Solderless Terminal | | |
|----------|---------------------------------|---------|-----------|
| | D (max) | t (max) | Qty (max) |
| +V / -V | 8.1mm | 0.8mm | 2 pcs |
| | | 1.0mm | 1 pc |
| Others | 6.8mm | 0.8mm | 2 pcs |

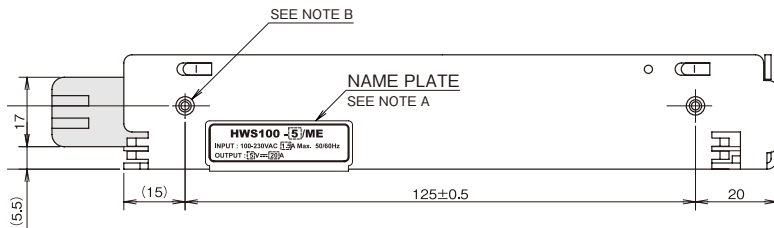

- NOTES
- A: MODEL NAME, INPUT VOLTAGE RANGE, NOMINAL OUTPUT VOLTAGE, MAXIMUM OUTPUT CURRENT AND COUNTRY OF MANUFACTURE ARE SHOWN HERE IN ACCORDANCE WITH THE SPECIFICATIONS.
 - B: M3 EMBOSSED, TAPPED AND COUNTERSUNK HOLES (2) FOR CUSTOMER CHASSIS MOUNTING. SCREWS MUST NOT PROTRUDE INTO POWER SUPPLY BY MORE THAN 6mm.
 - C: M3 TAPPED HOLES (2) FOR CUSTOMER CHASSIS MOUNTING. SCREWS MUST NOT PROTRUDE INTO POWER SUPPLY BY MORE THAN 6mm.

ACCESSORIES
 * SHORT PIECE (NET 2) FOR SHORTING PURPOSE (+S to +V, -S to -V) : MOUNTED AT TIME OF SHIPMENT.

HWS /ME

OUTPUT DERATING

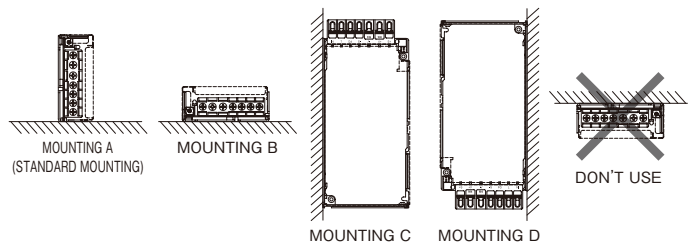
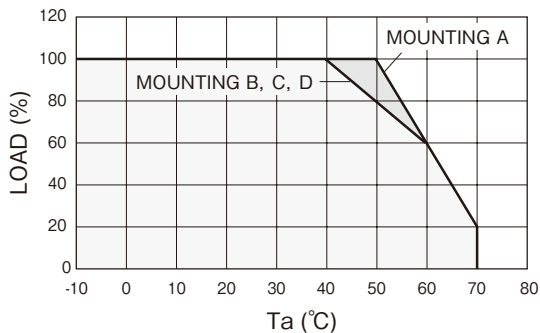

●Please refer to instruction manual. A-155

HWS150/ME Specifications

| ITEMS/UNITS | | MODEL | HWS150-5/ME | HWS150-12/ME | HWS150-15/ME | HWS150-24/ME | HWS150-48/ME |
|-------------|--|----------|---|--------------|--------------|--------------|--------------|
| Input | Voltage Range | (*2) V | AC85 - 265 or DC120 - 370 | | | | |
| | Frequency | (*2) Hz | 47 - 63 | | | | |
| | Power Factor (100/200VAC)(typ) | (*1) | 0.99 / 0.95 | | | | |
| | Efficiency (100/200VAC)(typ) | (*1) % | 83 / 86 | | 85 / 88 | | |
| | Current (100/200VAC)(typ) | (*1) A | 1.9 / 0.95 | | | | |
| | Inrush Current (100/200VAC)(typ) | (*3) A | 14 / 28 at Ta=25°C, cold start | | | | |
| | Leakage Current | (*10) mA | Less than 0.5. (0.2 (typ) at 100VAC / 0.4 (typ) at 230VAC) | | | | |
| Output | Nominal Voltage | VDC | 5 | 12 | 15 | 24 | 48 |
| | Maximum Current | A | 30 | 13 | 10 | 6.5 | 3.3 |
| | Maximum Power | W | 150 | 156 | 150 | 156 | 158.4 |
| | Maximum Line Regulation | (*5) mV | 20 | 48 | 60 | 96 | 192 |
| | Maximum Load Regulation | (*6) mV | 40 | 96 | 120 | 192 | 384 |
| | Temperature Coefficient (%) | | Less than 0.02% / °C | | | | |
| | Maximum Ripple & Noise (0≤Ta≤70°C) (*4) | mVp-p | 120 | 150 | | | 200 |
| | Maximum Ripple & Noise (-10≤Ta<0°C) (*4) | mVp-p | 160 | 180 | | | 240 |
| | Hold-up Time (typ) | (*9) ms | 20 | | | | |
| | Voltage Adjustable Range | VDC | 4.0 - 6.0 | 9.6 - 14.4 | 12.0 - 18.0 | 19.2 - 28.8 | 38.4 - 52.8 |
| Function | Over Current Protection | (*7) A | >31.5 | >13.6 | >10.5 | >6.82 | >3.46 |
| | Over Voltage Protection | (*8) VDC | 6.25 - 7.25 | 15.0 - 17.4 | 18.8 - 21.8 | 30.0 - 34.8 | 55.2 - 64.8 |
| | Remote Sensing | | Possible | | | | |
| | Parallel Operation | | - | | | | |
| | Series Operation | | Possible | | | | |
| | Line DIP | | Designed to meet SEMI-F47 (200VAC Line only) | | | | |
| Environment | Operating Temperature | (*11) °C | -10 to +70 (-10 to +50: 100%, +60: 60%, +70: 20%) | | | | |
| | Storage Temperature | °C | -30 to +85 | | | | |
| | Operating Humidity | %RH | 30 - 90 (No dewdrop) | | | | |
| | Storage Humidity | %RH | 10 - 95 (No dewdrop) | | | | |
| | Vibration | | At no operating, 10 - 55Hz (sweep for 1min) 19.6m/s ² constant, X, Y, Z 1hour each. | | | | |
| | Shock (In package) | | Less than 196.1m/s ² | | | | |
| | Cooling | | Convection cooling | | | | |
| Isolation | Withstand Voltage | | Input - FG : 2kVAC (20mA), Input - Output : 3kVAC (20mA) Output - FG : 500VAC (100mA) for 1min | | | | |
| | Isolation Resistance | | More than 100MΩ at 25°C and 70%RH Output - FG : 500VDC | | | | |
| Standards | Safety Standards | (*12) | Approved by UL60601-1, EN60601-1, CSA-C22.2 No.601.1-M90 | | | | |
| | PFHC | | Designed to meet IEC61000-3-2 | | | | |
| | Voltage Fluctuations / Flicker Emissions | | Designed to meet IEC61000-3-3 | | | | |
| | EMI | | Designed to meet EN55011/EN55022-B, FCC-B, VCCI-B | | | | |
| Mechanical | Immunity | | Designed to meet IEC61000-4-2(Level 3), -3(Level 3), -4(Level 3), -5(Level 3,4), -6(Level 3), -8(Level 4), -11 | | | | |
| | Weight (typ) | g | 500 | | | | |
| | Size (W x H x D) | mm | 37 x 82 x 160 (Refer to outline drawing) | | | | |

HWS
/ME

- (*1) At 100/200VAC, Ta=25°C and maximum output power.
- (*2) For cases where conformance to various safety specs (UL, EN, CSA) are required, to be described as 100 - 230VAC (50/60Hz).
- (*3) Not applicable for the in-rush current to noise filter for less than 0.2ms.
- (*4) Measure with JEITA RC-9131A probe, bandwidth of scope: 100MHz.
- (*5) 85 - 265VAC, constant load.
- (*6) No load-full load, constant input voltage.
- (*7) Constant current limit and Hiccup with automatic recovery.
Not operate at over load or dead short condition for more than 30 seconds.
- (*8) OVP circuit will shutdown output, manual reset (re power on).
- (*9) At 100/200VAC, nominal output voltage and maximum output current.
- (*10) Measured by the each measuring method of UL, EN and CSA (at 60Hz).
When using it as a patient care equipment, all outer surfaces of the equipment shall be constructed of nonconductive material. See clause 19.5DV.2 of UL60601-1.
- (*11) Ratings - Derating at standard mounting.
- Load (%) is percent of maximum output power or maximum output current, whichever is greater.
- As for other mountings, refer to derating curve.
- (*12) As for UL60601-1, EN60601-1 and CSA-C22.2 No.601.1-M90, basic insulation.

● Recommended EMC Filter

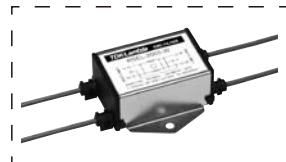

RSEL-2003WL
Please refer to "TDK-Lambda EMC Filters" catalog.

Outline Drawing

[HWS150/ME]

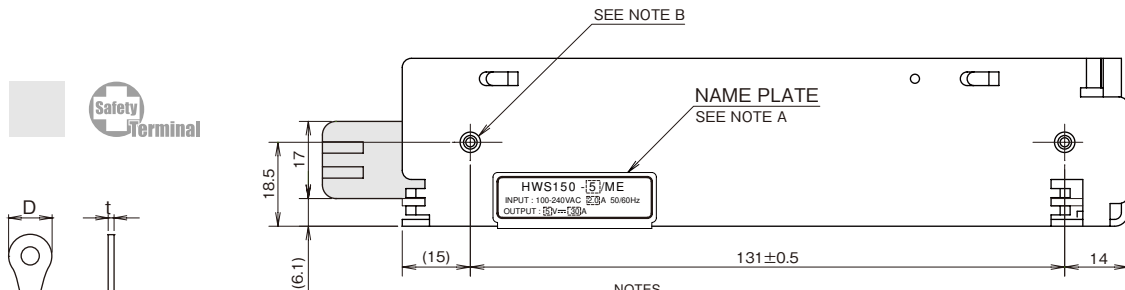
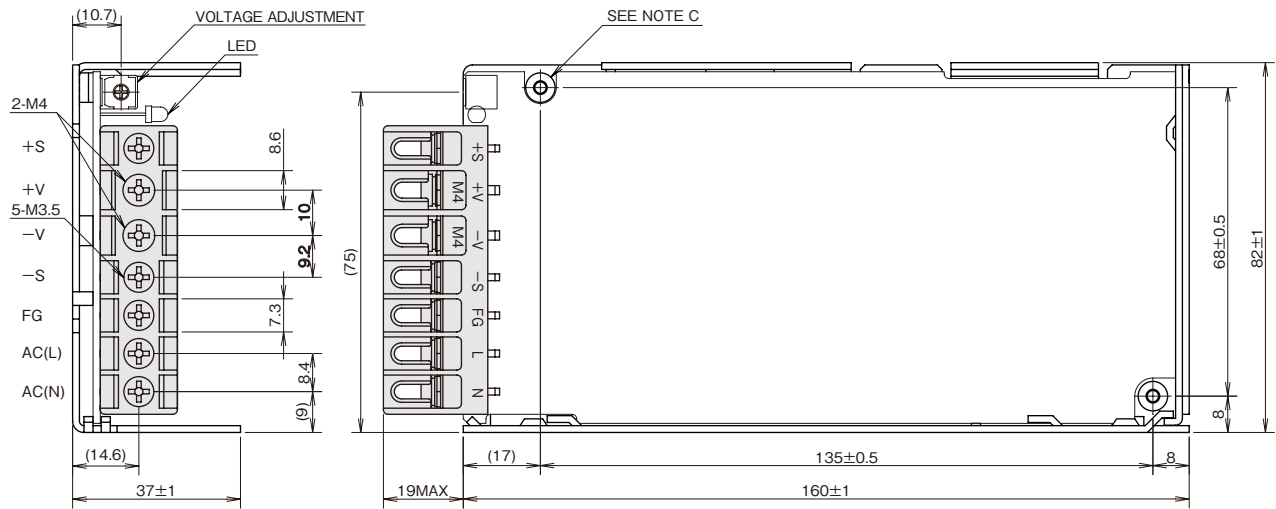

| Terminal | Recommended Solderless Terminal | | |
|----------|---------------------------------|--------|-----------|
| | D (max) | t(max) | Qty (max) |
| +V / -V | 8.1mm | 0.8mm | 2 pcs |
| | | 1.0mm | 1 pc |
| Others | 6.8mm | 0.8mm | 2 pcs |

NOTES

A: MODEL NAME, INPUT VOLTAGE RANGE, NOMINAL OUTPUT VOLTAGE, MAXIMUM OUTPUT CURRENT AND COUNTRY OF MANUFACTURE ARE SHOWN HERE IN ACCORDANCE WITH THE SPECIFICATIONS.

B: M3 EMBOSSED, TAPPED AND COUNTERSUNK HOLES (2) FOR CUSTOMER CHASSIS MOUNTING. SCREWS MUST NOT PROTRUDE INTO POWER SUPPLY BY MORE THAN 6mm.

C: M3 TAPPED HOLES (2) FOR CUSTOMER CHASSIS MOUNTING. SCREWS MUST NOT PROTRUDE INTO POWER SUPPLY BY MORE THAN 6mm.

ACCESSORIES

* SHORT PIECE (NET 2) FOR SHORTING PURPOSE (+S to +V, -S to -V) : MOUNTED AT TIME OF SHIPMENT.

OUTPUT DERATING

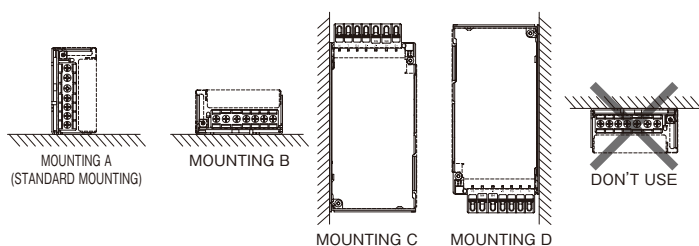
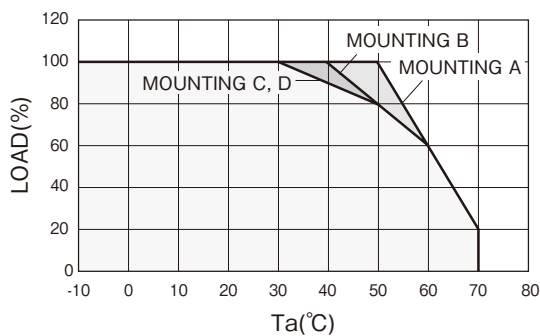

● Please refer to instruction manual. A-155

HKS300/ME Specifications

| ITEMS/UNITS | | MODEL | HWS300-12/ME | HWS300-15/ME | HWS300-24/ME | HWS300-48/ME |
|-------------|--|------------|---|--------------|--------------|--------------|
| Input | Voltage Range | (*3) V | AC85 - 265 or DC120 - 330 | | | |
| | Frequency | (*3) Hz | 47 - 63 | | | |
| | Power Factor (100/200VAC)(typ) | (*2) | 0.99 / 0.95 | | | |
| | Efficiency (100/200VAC)(typ) | (*2) % | 80 / 83 | | 82 / 85 | |
| | Current (100/200VAC)(typ) | (*2) A | 4.1 / 2.1 | | | |
| | Inrush Current (100/200VAC)(typ) | (*4) A | 20 / 40 | | | |
| | Leakage Current | (*11) mA | Less than 0.5. (0.15 (typ) at 100VAC / 0.39 (typ) at 230VAC) | | | |
| Output | Nominal Voltage | VDC | 12 | 15 | 24 | 48 |
| | Maximum Current | (*1) A | 27 | 22 | 14 (16.5) | 7 |
| | Maximum Power | W | 324 | 330 | 336 | 336 |
| | Maximum Line Regulation | (*6) mV | 48 | 60 | 96 | 192 |
| | Maximum Load Regulation | (*7) mV | 72 | 90 | 144 | 288 |
| | Temperature Coefficient | | Less than 0.02% / °C | | | |
| | Maximum Ripple & Noise (0≤Ta<70°C) | (*5) mVp-p | 150 | | 350 | |
| | Maximum Ripple & Noise (-10≤Ta<0°C) | (*5) mVp-p | 200 | | 400 | |
| | Hold-up Time (typ) | (*10) ms | 20 | | | |
| | Voltage Adjustable Range | VDC | 9.6 - 14.4 | 12.0 - 18.0 | 19.2 - 28.8 | 38.4 - 52.8 |
| Function | Over Current Protection | (*8) A | >28.4 | >23.1 | >16.7 | >7.4 |
| | Over Voltage Protection | (*9) VDC | 15.0 - 17.4 | 18.8 - 21.8 | 30.0 - 34.8 | 55.2 - 64.8 |
| | Remote Sensing | | Possible | | | |
| | Remote ON/OFF Control | | Possible | | | |
| | Parallel Operation | | Possible | | | |
| | Series Operation | | Possible | | | |
| | Monitoring Signal | | PF (Open collector output) | | | |
| | Line DIP | | Designed to meet SEMI-F47 (200VAC Line only) | | | |
| Environment | Operating Temperature | (*12) °C | -10 to +70 (-10 to +50: 100%, +70: 50%) | | | |
| | Storage Temperature | °C | -30 to +85 | | | |
| | Operating Humidity | %RH | 10 to 90 (No dewdrop) | | | |
| | Storage Humidity | %RH | 10 to 95 (No dewdrop) | | | |
| | Vibration | | At no operating, 10 - 55Hz (sweep for 1min) 19.6m/s ² constant, X, Y, Z 1hour each. | | | |
| | Shock (In package) | | Less than 196.1m/s ² | | | |
| | Cooling | | Forced air by blower fan | | | |
| Isolation | Withstand Voltage | | Input - FG : 2.5kVAC (20mA), Input - Output : 3kVAC (20mA) Output - FG: 500VAC (100mA), Output-CNT: 100VAC(100mA) for 1min | | | |
| | Isolation Resistance | | More than 100MΩ Output - FG : 500VDC More than 10MΩ Output -CNT : 100VDC at 25°C and 70%RH | | | |
| Standards | Safety Standards | (*13) | Approved by UL60601-1, EN60601-1, CSA-C22.2 No601.1-M90 | | | |
| | PFHC | | Designed to meet IEC61000-3-2 | | | |
| | Voltage Fluctuations / Flicker Emissions | | Designed to meet IEC61000-3-3 | | | |
| | EMI | | Designed to meet EN55011/EN55022-B, FCC-B, VCCI-B | | | |
| Mechanical | Immunity | | Designed to meet IEC61000-4-2(Level 3), -3(Level 3), -4(Level 3), -5(Level 3,4), -6(Level 3), -8(Level 4), -11 | | | |
| | Weight (typ) | g | 1000 | | | |
| | Size (W x H x D) | mm | 61 x 82 x 165 (Refer to outline drawing) | | | |

HWS
/ME

(*1) ():Peak output current at 200VAC. Operating time at peak output is less than 10 sec, duty is less than 35%.

(*2) At 100/200VAC, Ta=25°C and maximum output power.

(*3) For cases where conformance to various safety specs (UL, EN, CSA) are required, to be described as 100 - 240VAC (50/60Hz).

(*4) Not applicable for the inrush current to noise filter for less than 0.2ms.

(*5) Measure with JEITA RC-9131A probe, bandwidth of scope: 100MHz.

(*6) 85 - 265VAC, constant load.

(*7) No load-full load, constant input voltage.

(*8) Constant current limit with automatic recovery.
Avoid to operate at over load or short circuit condition for more than 30 seconds.

(*9) OVP circuit will shut the output down, manual reset (CNT reset or re power on).

(*10) At 100/200VAC, nominal output voltage and maximum output current.

(*11) Measured by the each measuring method of UL, EN, and CSA (at 60Hz), Ta=25°C.
When using it as a patient care equipment, all outer surfaces of the equipment shall be constructed of nonconductive material. See clause 19.5DV.2 of UL60601-1.

(*12) Ratings - Derating at standard mounting. Refer to output derating curve.
- Load (%) is percent of maximum output power or maximum output current, whichever is greater.

(*13) As for UL60601-1, EN60601-1 and CSA-C22.2No601.1-M90, basic insulation.

● Recommended EMC Filter



RSEN-2006L
Please refer to "TDK-Lambda
EMC Filters" catalog.

Outline Drawing

[HWS300/ME]

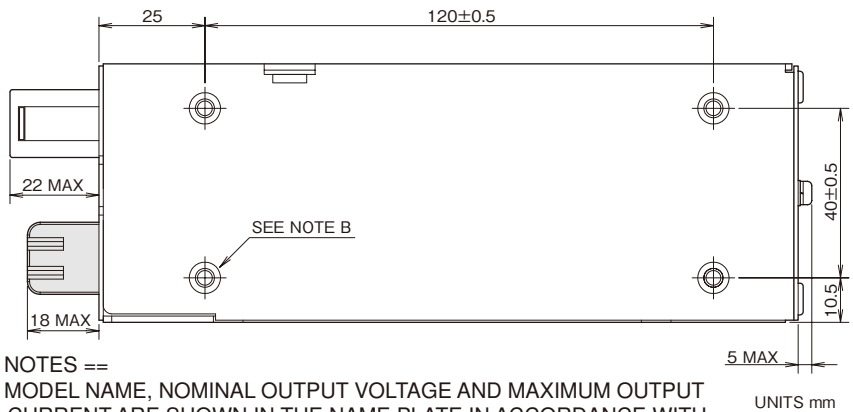
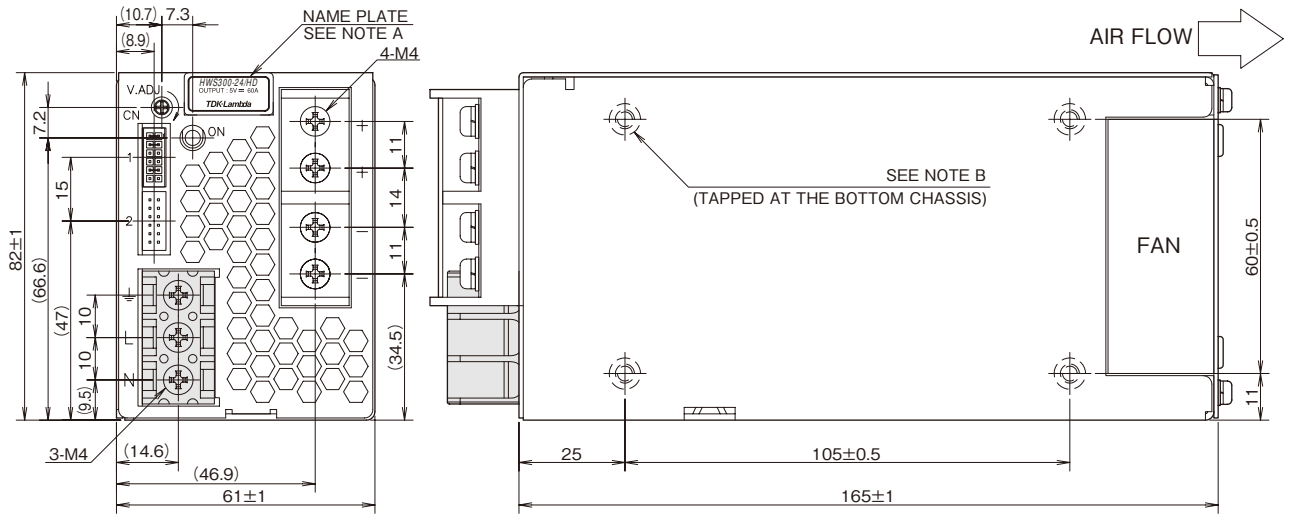

HWS/ME

== NOTES ==

- A : MODEL NAME, NOMINAL OUTPUT VOLTAGE AND MAXIMUM OUTPUT CURRENT ARE SHOWN IN THE NAME PLATE IN ACCORDANCE WITH THE SPECIFICATIONS.
- B : M4 TAPPED HOLES (8) FOR CUSTOMER CHASSIS MOUNTING. (SCREW PENETRATION DEPTH 6m/m MAX.)

UNITS mm

== SIGNAL CONNECTOR USED ==

| PART DESCRIPTION | PART NAME | MANUFACT |
|------------------|------------|----------|
| PIN HEADER | S12B-PHDSS | JST |

== MATCHING HOUSINGS , PINS & TOOL ==

| PART DESCRIPTION | PART NAME | MANUFACT |
|--------------------|--|----------|
| SOCKET HOUSING | PHDR-12VS | JST |
| TERMINAL PINS | SPHD-002T-P0.5(AWG28~24) SPHD-001T-P0.5(AWG26~22) | JST |
| HAND CRIMPING TOOL | YRS-620(SPHD-002T-P0.5) YC-610R(SPHD-001T-P0.5) | JST |

== ACCESSORIES ==

- *COVER FOR BARRIER TERMINAL STRIP -----1 (ATTACHED ON TERMINAL AT SHIPMENT)
- *SHORT PIECE -----1 SHORTING +Vm—+S, -Vm—-S, CNT—TOG (ATTACHED ON CN1 AT SHIPMENT)

OUTPUT DERATING

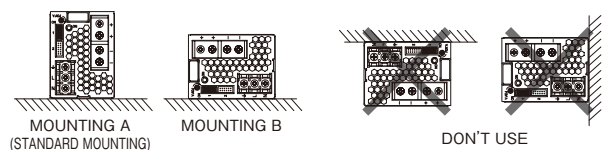
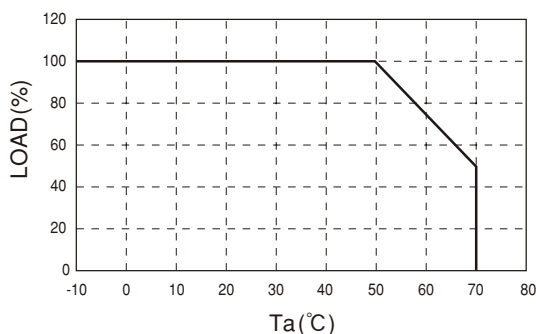

●Please refer to instruction manual. A-161

HWS600/ME Specifications

| ITEMS/UNITS | MODEL | HWS600-24/ME |
|-------------|---|--|
| Input | Voltage Range (*3) | V AC85 - 265 or DC120 - 330 |
| | Frequency (*3) | Hz 47 - 63 |
| | Power Factor (100/200VAC)(typ)(*2) | 0.99 / 0.95 |
| | Efficiency (100/200VAC)(typ) (*2) | % 82 / 85 |
| | Current (100/200VAC)(typ) (*2) | A 8.1 / 3.9 |
| | Inrush Current (100/200VAC)(typ)(*4) | A 20 / 40 |
| Output | Leakage Current (*11) | mA Less than 0.5. (0.12 (typ) at 100VAC / 0.34 (typ) at 230VAC) |
| | Nominal Voltage | VDC 24 |
| | Maximum Current (*1) | A 27 (31) |
| | Maximum Power | W 648 |
| | Maximum Line Regulation (*6) | mV 96 |
| | Maximum Load Regulation (*7) | mV 144 |
| | Temperature Coefficient (%) | Less than 0.02% / °C |
| | Maximum Ripple & Noise (0<Ta<70°C) (*5) | mVp-p 150 |
| | Maximum Ripple & Noise (-10<Ta< 0°C) (*5) | mVp-p 200 |
| | Hold-up Time (typ) (*10) | ms 20 |
| Function | Voltage Adjustable Range | VDC 19.2 - 28.8 |
| | Over Current Protection (*8) | A >31.4 |
| | Over Voltage Protection (*9) | VDC 30.0 - 34.8 |
| | Remote Sensing | Possible |
| | Remote ON/OFF Control | Possible |
| | Parallel Operation | Possible |
| | Series Operation | Possible |
| | Monitoring Signal | PF (Open collector output) |
| Environment | Line DIP | Designed to meet SEMI-F47 (200VAC Line only) |
| | Operating Temperature (*12) | °C -10 to +70 (-10 - +50: 100%, +70: 50%) |
| | Storage Temperature | °C -30 to +85 |
| | Operating Humidity | %RH 10 - 90 (No dewdrop) |
| | Storage Humidity | %RH 10 - 95 (No dewdrop) |
| | Vibration | At no operating, 10 - 55Hz (sweep for 1min) 19.6m/s ² constant, X,Y,Z 1hour each. |
| | Shock (In package) | Less than 196.1m/s ² |
| Isolation | Cooling | Forced air by blower fan |
| | Withstand Voltage | Input - FG : 2.5kVAC (20mA), Input - Output : 3kVAC (20mA) Output - FG : 500VAC (100mA), Output - CNT : 100VAC (100mA) for 1min |
| Standards | Isolation Resistance | More than 100MΩ Output - FG : 500VDC More than 10MΩ Output - CNT : 100VDC at 25°C and 70%RH |
| | Safety Standards (*13) | Approved by UL60601-1, EN60601-1, CSA-C22.2 No601.1-M90 |
| | PFHC | Designed to meet IEC61000-3-2 |
| | Voltage Fluctuations / Flicker Emissions | Designed to meet IEC61000-3-3 |
| | EMI | Designed to meet EN55011/EN55022-A, FCC-A, VCCI-A |
| Mechanical | Immunity | Designed to meet IEC61000-4-2(Level 3), -3(Level 3), -4(Level 3), -5(Level 3,4), -6(Level 3), -8(Level 4), -11 |
| | Weight (typ) | g 1600 |
| | Size (W x H x D) | mm 100 x 82 x 165 (Refer to outline drawing) |

HWS
/ME

(*1) () : Peak output current at 200VAC. Operating time at peak output is less than 10 sec, duty is less than 35%.

(*2) At 100/200VAC, Ta=25°C and maximum output power.

(*3) For cases where conformance to various safety specs (UL, CSA, EN) are required, to be described as 100 - 240VAC (50/60Hz).

(*4) Not applicable for the inrush current to noise filter for less than 0.2ms. Inrush current is 30A (typ) when PFHC start-up.

(*5) Measure with JEITA RC-9131A probe, bandwidth of scope: 100MHz.

(*6) 85 - 265VAC, constant load.

(*7) No load - full load, constant input voltage.

(*8) Constant current limit with automatic recovery. Avoid to operate at over load or short circuit condition for more than 30 seconds.

(*9) OVP circuit will shut the output down, manual reset (CNT reset or re-power on).

(*10) At 100/200VAC, nominal output voltage and maximum output current.

(*11) Measured by the each measuring method of UL, EN, and CSA (at 60Hz), Ta=25°C. When using it as a patient care equipment, all outer surfaces of the equipment shall be constructed of nonconductive material. See clause 19.5DV.2 of UL60601-1.

(*12) Ratings - Derating at standard mounting. Refer to output derating curve. - Load (%) is percent of maximum output power or maximum output current, whichever is greater.

(*13) As for UL60601-1, EN60601-1 and CSA-C22.2 No601.1-M90, basic insulation.

● Recommended EMC Filter



RSEN-2016L
Please refer to "TDK-Lambda EMC Filters" catalog.

Outline Drawing

[HWS600/ME]

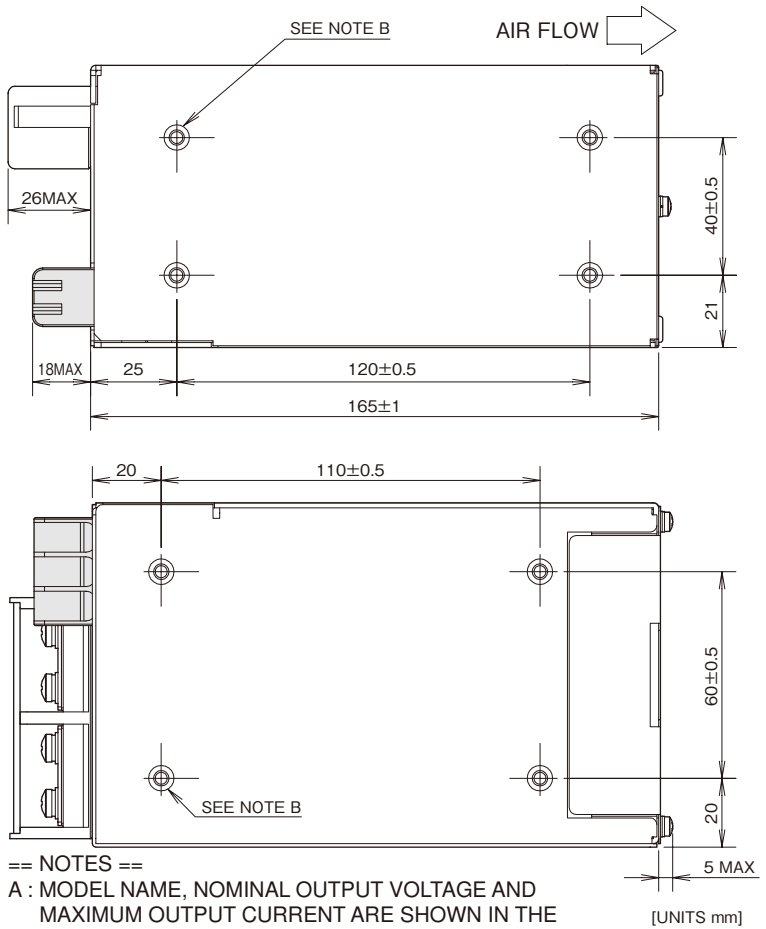
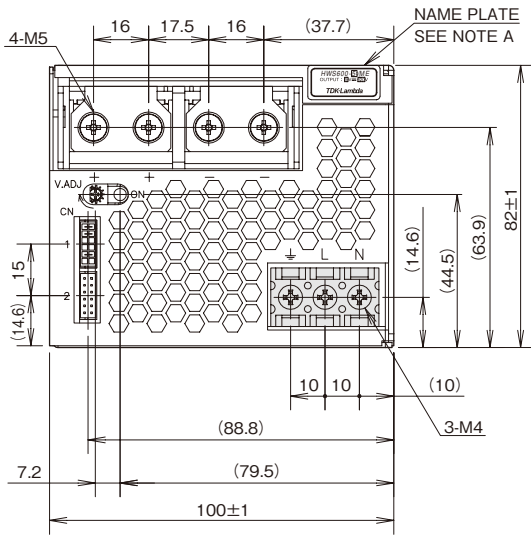

== SIGNAL CONNECTOR USED ==

| PART DESCRIPTION | PART NAME | MANUFACT |
|------------------|------------|----------|
| PIN HEADER | S12B-PHDSS | JST |

== MATCHING HOUSINGS , PINS & TOOL ==

| PART DESCRIPTION | PART NAME | MANUFACT |
|--------------------|--|----------|
| SOCKET HOUSING | PHDR-12VS | JST |
| TERMINAL PINS | SPHD-002T-P0.5(AWG28~24) SPHD-001T-P0.5(AWG26~22) | JST |
| HAND CRIMPING TOOL | YRS-620(SPHD-002T-P0.5) YC-610R(SPHD-001T-P0.5) | JST |

== NOTES ==

A : MODEL NAME, NOMINAL OUTPUT VOLTAGE AND MAXIMUM OUTPUT CURRENT ARE SHOWN IN THE NAME PLATE IN ACCORDANCE WITH THE SPECIFICATIONS.

B : M4 TAPPED HOLES (8) FOR CUSTOMER CHASSIS MOUNTING.
(SCREW PENETRATION DEPTH 6mm MAX.)

== ACCESSORIES ==

- *COVER FOR BARRIER TERMINAL STRIP -----1 (ATTACHED ON TERMINAL AT SHIPMENT)
- *SHORT PIECE -----1 SHORTING +Vm—+S, -Vm—S, CNT—TOG (ATTACHED ON CN1 AT SHIPMENT)

OUTPUT DERATING

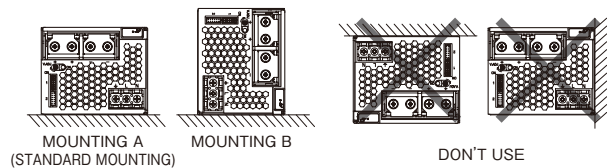
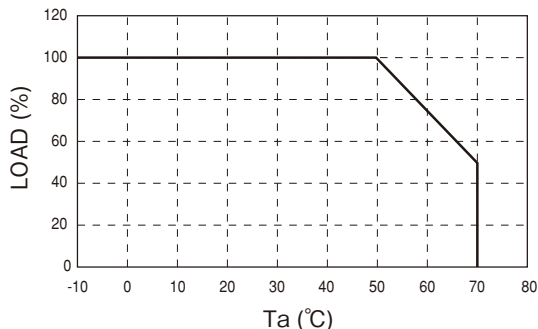

●Please refer to instruction manual. A-161

HWS1500/ME Specifications

| ITEMS/UNITS | | MODEL | HWS1500-24/ME | HWS1500-36/ME | HWS1500-48/ME |
|------------------------------|--|------------------------------|---|---------------|---------------|
| Input | Voltage Range | (*2) V | AC85 - 265 | | |
| | Frequency | (*2) Hz | 47 - 63 | | |
| | Power Factor (100/230VAC)(typ)(*1) | | 0.98 / 0.94 | | |
| | Efficiency (100/200VAC)(typ) (*1) | % | 84 / 88 | | 86 / 90 |
| | Current (100/200VAC)(typ) (*1) | A | 19.0 / 10.0 | | |
| | Inrush Current (100/200VAC)(typ)(*3) | A | 20 / 40 | | |
| | Leakage Current | (*10) mA | Less than 0.5. (0.2 (typ) at 100VAC / 0.4 (typ) at 230VAC) | | |
| Output | Nominal Voltage | VDC | 24 | 36 | 48 |
| | Maximum Current (100/200VAC) | A | 65 / 70 | 42 / 46.5 | 32 / 32 |
| | Maximum Peak Current (200VAC)(*13) | A | 105 | 70 | - |
| | Maximum Power (100/200VAC) | W | 1560 / 1680 | 1512 / 1674 | 1536 / 1536 |
| | Maximum Peak Power (200VAC)(*13) | W | 2520 | | - |
| | Maximum Line Regulation (*5) | mV | 96 | 144 | 192 |
| | Maximum Load Regulation (*6) | mV | 144 | 150 | 288 |
| | Temperature Coefficient | | Less than 0.02%/°C | | |
| | Maximum Ripple & Noise (0~+70°C)(*4) | mVp-p | 200 | | |
| | Maximum Ripple & Noise (-10~0°C)(*4) | mVp-p | 240 | | 400 |
| | Hold-up Time (typ) | (*9) ms | 20 | | |
| | Voltage Adjustable Range | VDC | 19.2 - 28.8 | 28.8 - 43.2 | 38.4 - 52.8 |
| | Function | Over Current Protection (*7) | | >105% | |
| Over Voltage Protection (*8) | | VDC | 30.0 - 34.8 | 45.0-49.7 | 55.2 - 64.8 |
| Remote Sensing | | | Possible | | |
| Remote ON/OFF Control | | | Possible | | |
| Parallel Operation | | | Possible | | |
| Series Operation | | | Possible | | |
| Monitoring Signal | | | PF (Open collector output) | | |
| Line DIP | | | Built to meet SEMI-F47 (200VAC Line only) | | |
| Environment | Operating Temperature (*11) | °C | -10 to +70 (-10 to +50: 100%, +60: 75%, +70: 50%), start up -20 to 70 | | |
| | Storage Temperature | °C | -30 to +85 | | |
| | Operating Humidity | %RH | 10 - 90 (No dewdrop) | | |
| | Storage Humidity | %RH | 10 - 95 (No dewdrop) | | |
| | Vibration | | At no operating, 10 - 55Hz (sweep for 1min.) 19.6m/s ² constant, X, Y, Z 1h each. | | |
| | Shock (In package) | | Less than 196.1m/s ² | | |
| | Cooling | | Forced air by blower fan | | |
| Isolation | Withstand Voltage | | Input - FG : 2kVAC (20mA), Input - Output : 3kVAC (20mA) Output-FG : 500VAC (300mA), Output-CNT:100VAC (100mA) for 1min. | | |
| | Isolation Resistance | | More than 100Mohm Output - FG ... 500VDC More than 10Mohm Output - CNT ... 100VDC at 25°C and 70%RH | | |
| Standards | Safety Standards (*12) | | Built to meet UL60601-1, EN60601-1, CSA-C22.2 No.601.1-M90 (C-UL) | | |
| | PFHC | | Built to meet IEC61000-3-2 | | |
| | Voltage Fluctuations / Flicker Emissions | | Built to meet IEC61000-3-3 | | |
| | EMI | | Built to meet EN55011 / EN55022-A, FCC-Class A, VCCI-Class A | | |
| Mechanical | Immunity | | Built to meet IEC61000-4-2(Level 2,3), -3(Level 3), -4(Level 3), -5(Level 3,4), -6(Level 3), -8(Level 4), -11 | | |
| | Weight (typ) | g | 3800 | | |
| | Size (W x H x D) | mm | 126.5 x 82 x 280 (Refer to outline drawing) | | |

HWS
/ME

- (*1) At Ta=25°C and maximum output power.
- (*2) For cases where conformance to various safety specs (UL, CSA, EN) are required, input voltage range will be 100 - 240VAC (50/60Hz).
- (*3) First in-rush current. Not applicable for the in-rush current to noise filter less than 0.2ms.
- (*4) Measure with JEITA RC-9131A probe, Bandwidth of scope :100MHz. (at 22uF electric capacitor and 0.47uF film capacitor on the test fixture board.)
- (*5) 85 - 265VAC, constant load.
- (*6) No load-Full load, constant input voltage.
- (*7) Constant current limit with automatic recovery. An output will be intercepted if it continues for about 5 seconds.
- (*8) OVP circuit will shut down output, manual reset (Power cycle) or ON/OFF CNT signal reset.
- (*9) At 100/200VAC, nominal output voltage and maximum output current.
- (*10) Measured by the each measuring method of UL, EN and CSA (at 60Hz).
When using it as a patient care equipment, all outer surfaces of the equipment shall be constructed of nonconductive material. See clause 19.5DV.2 of UL60601-1.
- (*11) Ratings - Derating at standard mounting.
- Load (%) is percent of maximum output power or maximum output current, whichever is greater.
- As for other mountings, refer to derating curve.
- (*12) As for UL60601-1, EN60601-1 and CSA-C22.2 No.601.1-M90 (C-UL) basic insulation.
- (*13) Peak output current is less than 10 seconds, and duty 35% max.

● Recommended EMC Filter



RSEN-2030L
Please refer to "TDK-Lambda EMC Filters" catalog.

Outline Drawing

[HWS1500/ME]

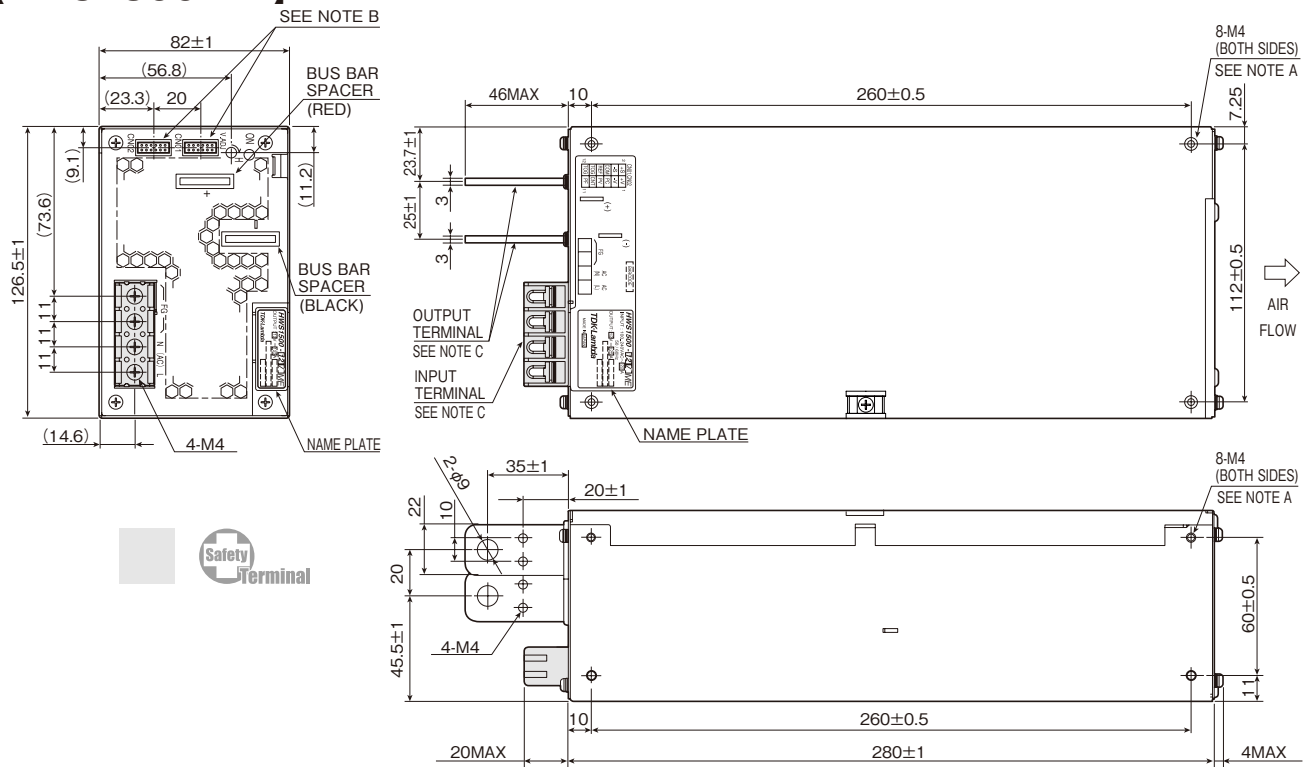

NOTES

- A: M4 TAPPED HOLES (16) FOR CUSTOMER CHASSIS MOUNTING.
 (SCREWS MUST NOT PROTRUDE INTO POWER SUPPLY BY MORE THAN 6mm/m.)
 (RECOMMENDED M4 SCREWS TORQUE : 1.27N·m)
- B : I/O SIGNAL CONNECTOR
 CONNECTOR : S12B-PHDSS(LF)(SN) (JST)
 MATCHING HOUSING : PHDR-12VS (JST)
 MATCHING CONTACT : SPHD-002T-P0.5(AWG28~24) (JST) OR
 SPHD-001T-P0.5(AWG26~22) (JST) OR
 BPHD-001T-P0.5(AWG26~22) (JST)
 HAND CRIMPING TOOL : YRS-620(SPHD-002T-P0.5) (JST)
 YC-610R(SPHD-001T-P0.5) (JST)
 YC-610R(BPHD-001T-P0.5) (JST)
- C : RECOMMENDED TORQUE FOR THE TERMINAL PIECE.
 INPUT TERMINAL (M4 SCREW) : 1.27N·m
 OUTPUT TERMINAL (M8 BOLT & NUT) : 10.8N·m
 OUTPUT TERMINAL (M4 SCREW) : 1.27N·m

(unit : mm)

ACCESSORIES

- * ATTACHED CONNECTOR
- SHORTING +S to +V, -S to -V, PV - REF & CNT - TDG
- ATTACHED ON CN01 AT SHIPMENT

OUTPUT DERATING

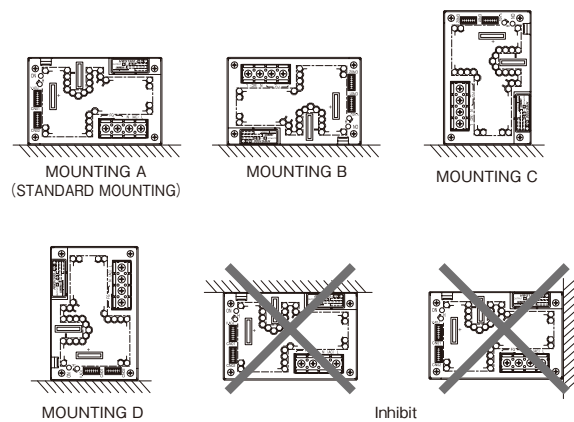
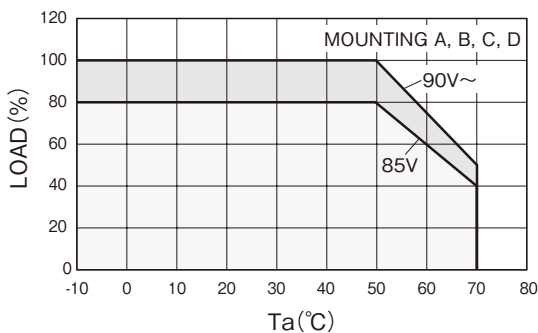

●Please refer to instruction manual. A-180

Block Diagram

[HWS15, HWS30]

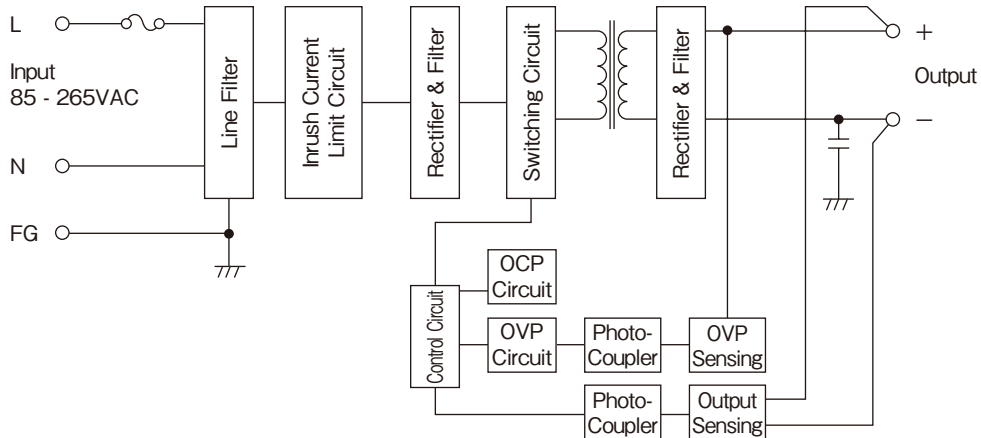

- Circuit topology, switching frequency
Flyback topology 70kHz (fixed)

- Fuse rating
HWS15 : 2A, HWS30 : 3.15A

[HWS50]

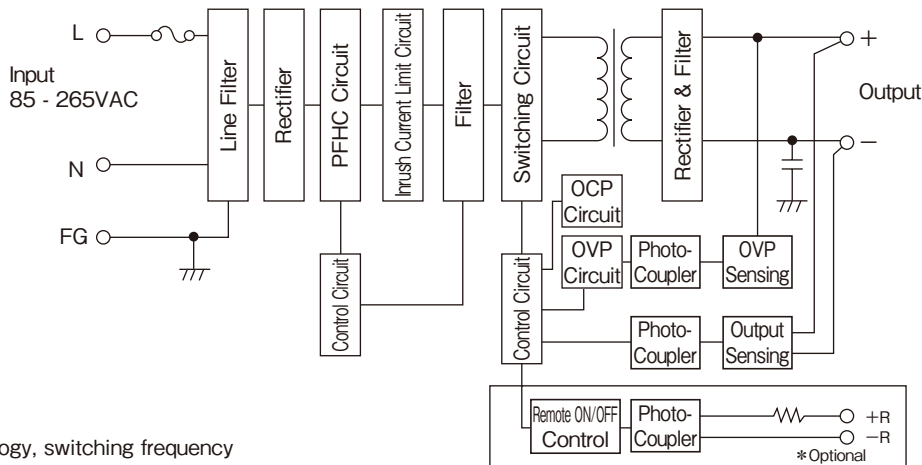

- Circuit topology, switching frequency
Single-ended forward topology 130kHz (fixed)
PFHC circuit : activ filter 90kHz (fixed)

- Fuse rating : 2A

[HWS80, HWS100, HWS150]

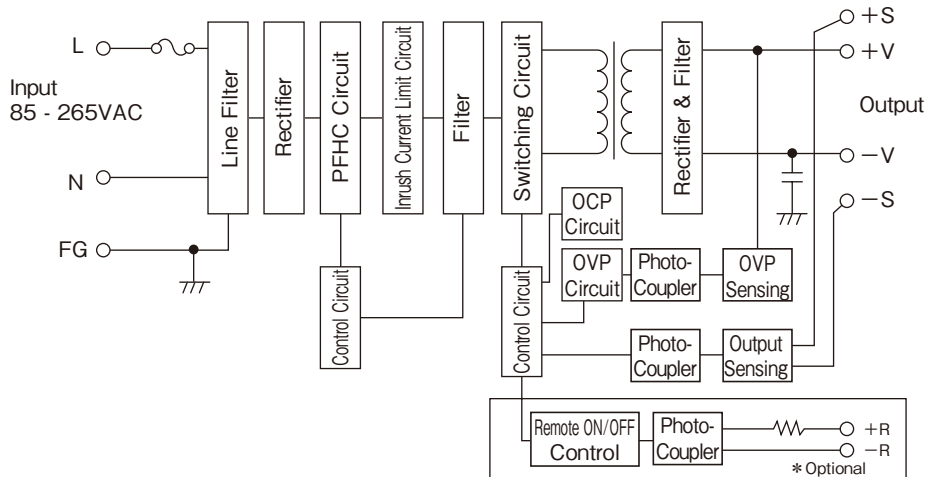

- Circuit topology, switching frequency
Cascade forward topology 120kHz (fixed)
PFHC circuit : activ filter 80kHz (fixed)

- Fuse rating :
HWS80, HWS100 : 3.15A, HWS150 : 5A

Block Diagram

[HWS300, HWS600]

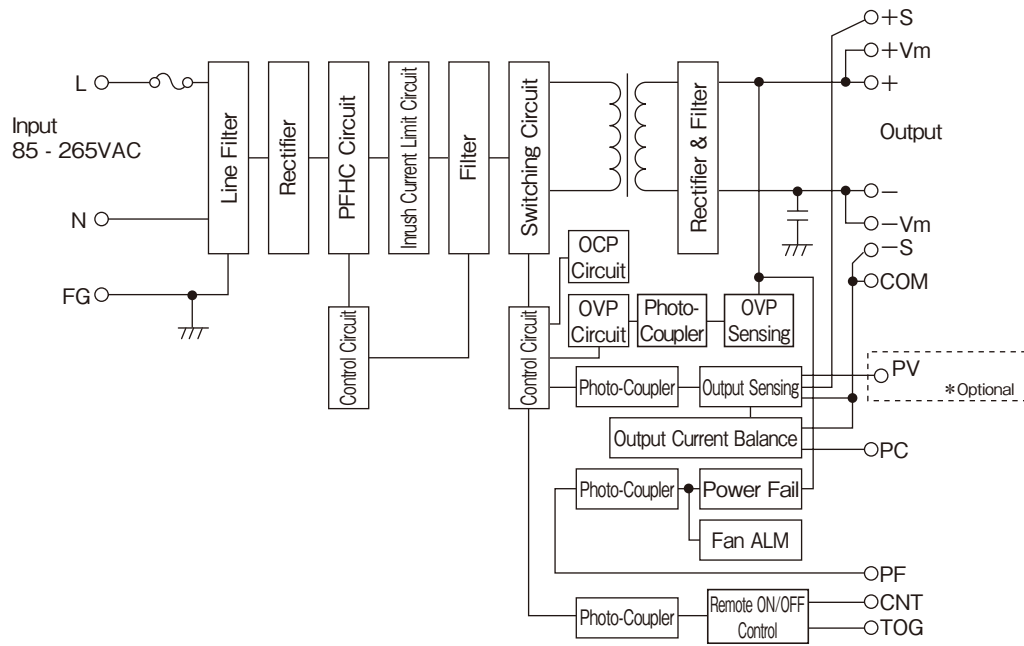

- Circuit topology, switching frequency
 Cascade forward topology 190kHz (fixed)
 PFHC circuit : active filter
 HWS300 : 80kHz (fixed) , HWS600 : 90kHz (fixed)

- Fuse rating :
 HWS300 : 10A, HWS600 : 15A

[HWS1000]

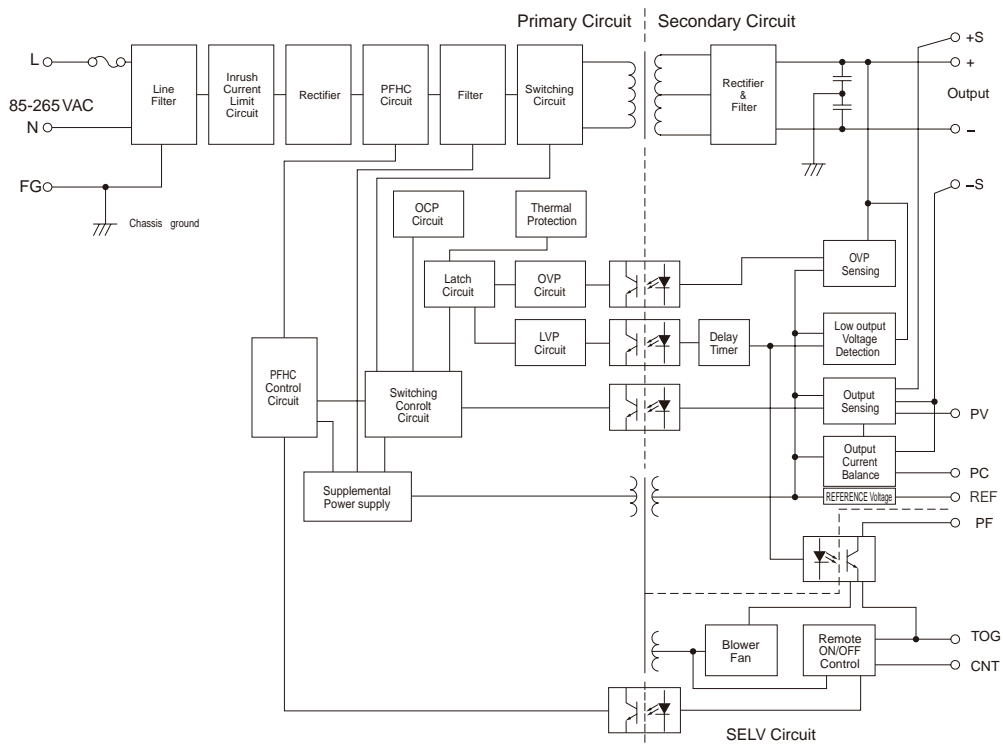

- SWITCHING CIRCUIT
 HALF-BRIDGE CONVERTER (53kHz)
- PFHC CIRCUIT ACTIVE FILTER (63kHz)
- FUSE RATING 20A
- FG FUNCTION GROUND

Block Diagram

[HWS1500]

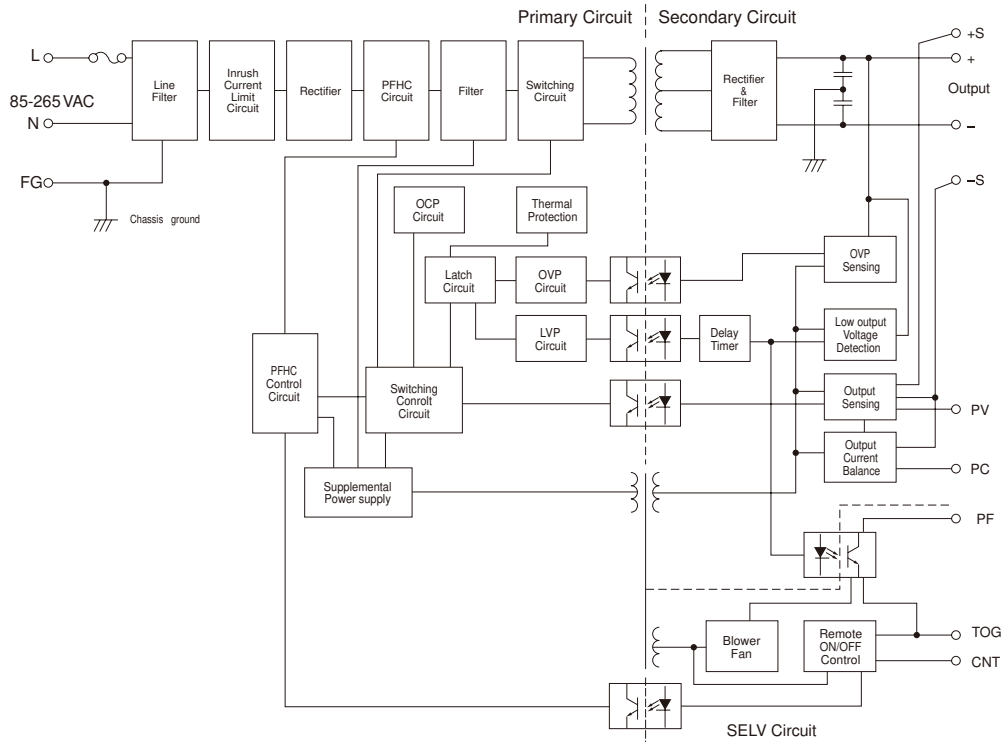

- Switching circuit
Half - bridge converter : 70kHz
- PFHC circuit : Active filter 65kHz
- Fuse rating : 30A
- FG : Function ground

[HWS1800T]

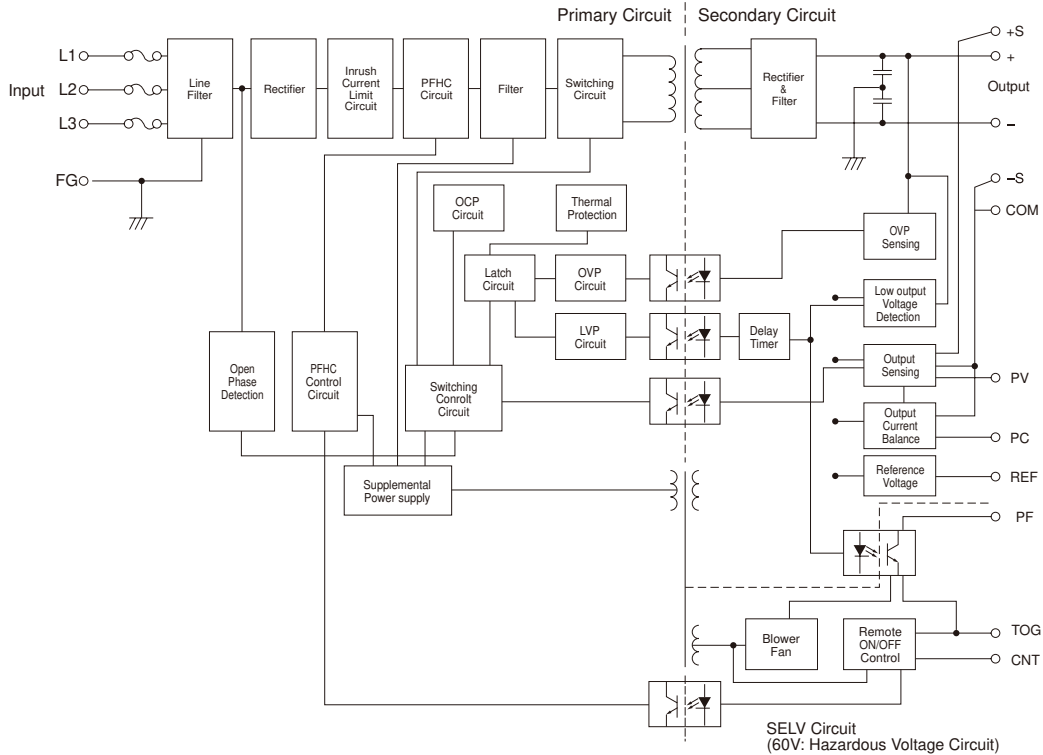

- Switching circuit
Half - bridge converter : 3 - 5V 45kHz (fixed), 6 - 7V 55kHz (fixed), 12 - 60V 70kHz (fixed)
- PFHC circuit : Active filter 65kHz (fixed)
- Fuse rating : 20A
- FG : FUNCTION GROUND

HWS

Sequence Time Chart

[HWS300, HWS600]

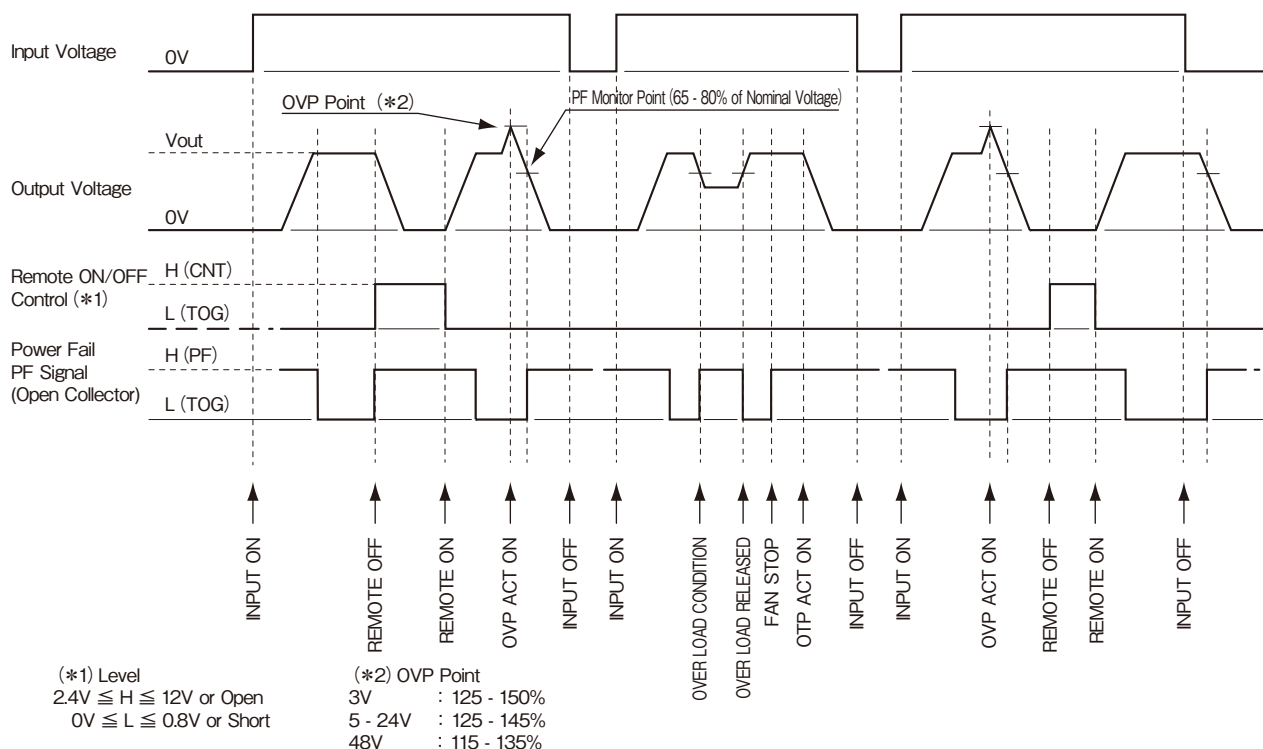

HWS

[HWS1000]

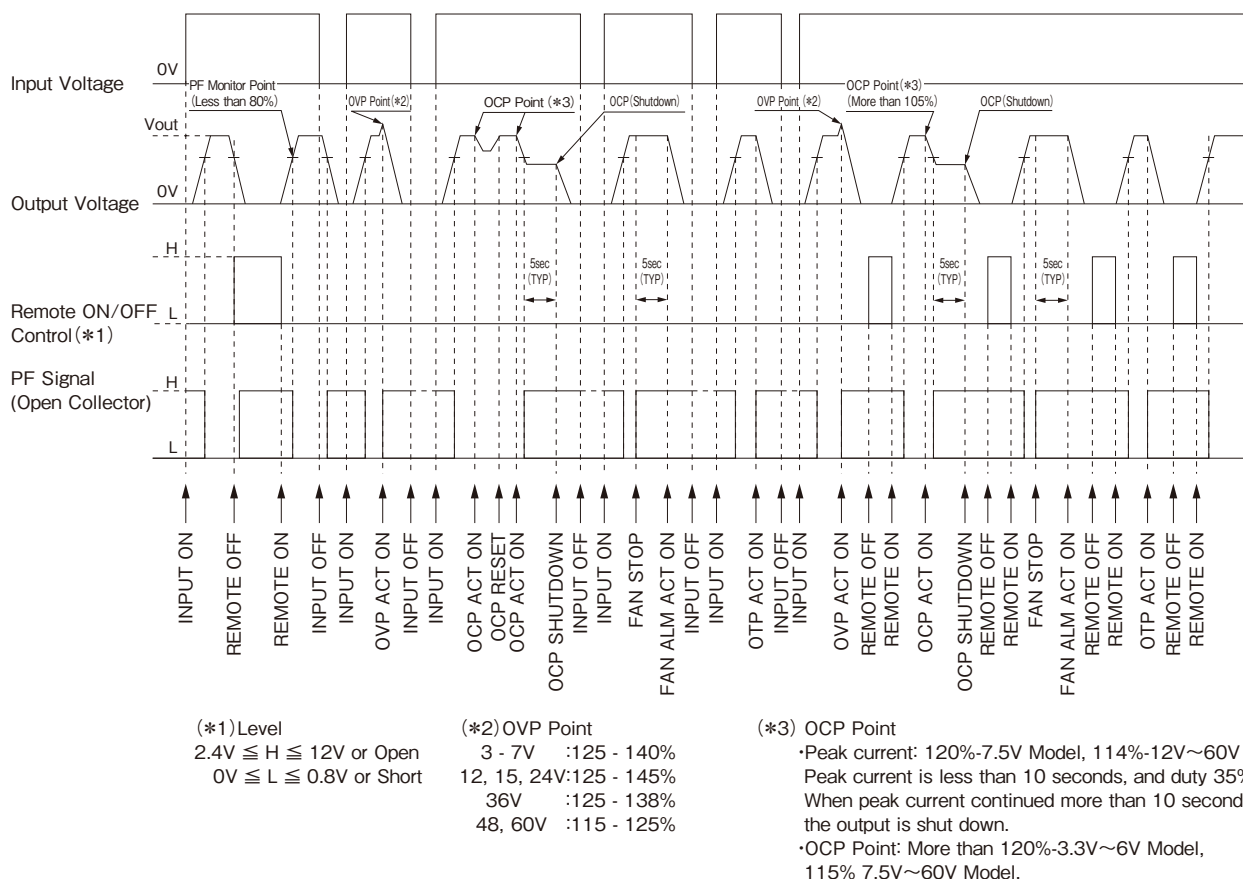

Sequence Time Chart

[HWS1500]

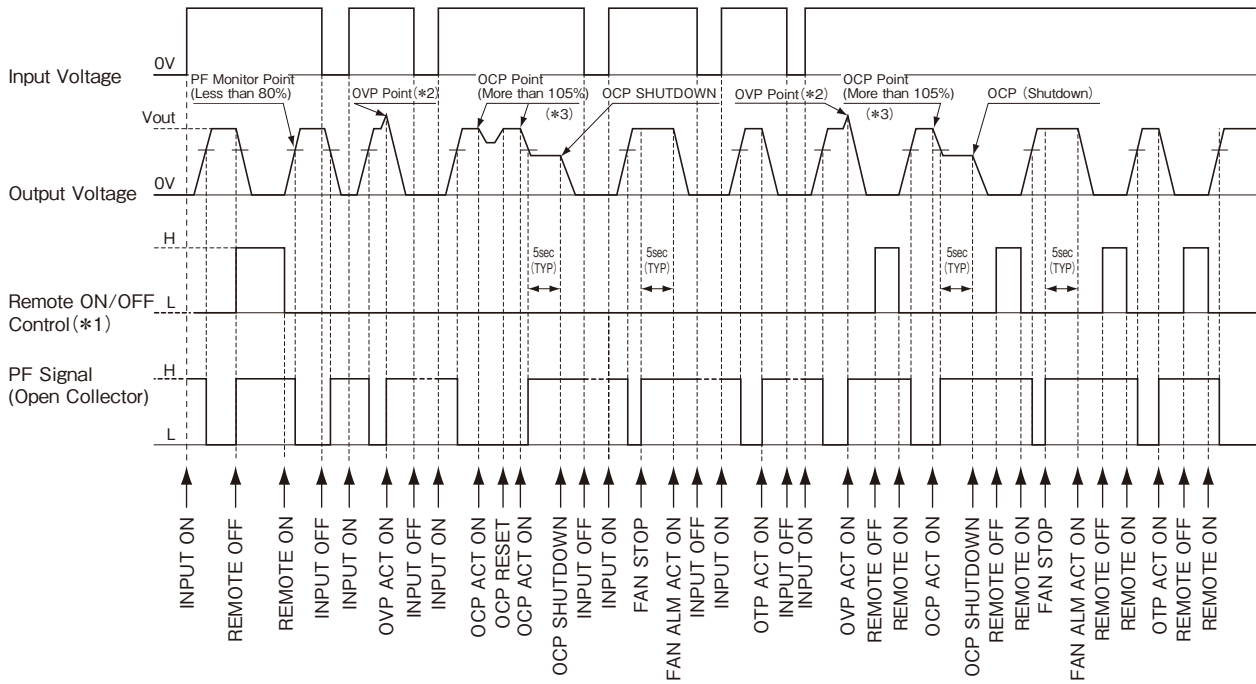

(*1) Level
 2.4V \leq H \leq 12V or Open
 0V \leq L \leq 0.8V or Short

(*2) OVP Point
 12, 15, 24V : 125 - 145%
 36V : 125 - 138%
 48V : 115 - 135%

(*3) OCP Point
 (24V, 36V models only, input voltage AC180 - 265V)
 •Peak Current: 150%
 Peak current is less than 10 seconds, and duty 35% max.
 When peak current continued more than 10 seconds, the output is shut down.
 •OCP Point : More than 150%

[HWS1800T]

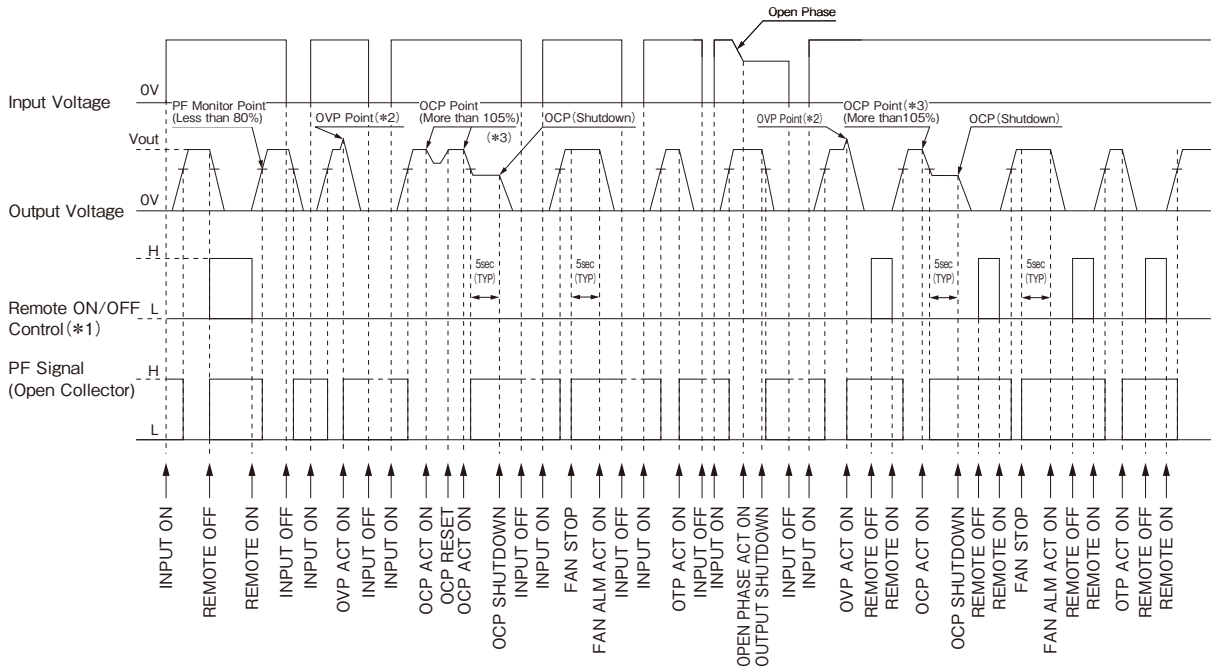

(*1) Level
 2.4V \leq H \leq 12V or Open
 0V \leq L \leq 0.8V or Short

(*2) OVP Point
 3 - 7V : 125 - 140%
 12, 15, 24V : 125 - 145%
 36V : 125 - 138%
 48, 60V : 115 - 125%

(*3) OCP Point
 •Peak Current: 120% (6V - 15V), 140% (24V - 60V)
 •Peak current is less than 10 seconds, and duty 35% max.
 When peak current continued more than 10 seconds, the output is shut down.
 •OCP Point: More than 120% (6V - 15V), More than 140% (24V - 60V)

HWS 15 -150 Series Instruction Manual

BEFORE USING THE POWER SUPPLY UNIT

Pay attention to all warnings and cautions before using the unit. Incorrect usage could lead to an electric shock, damage to the unit or a fire hazard.

⚠ WARNING and CAUTION

- Do not modify.
- Do not touch the internal components, they may have high voltage or high temperature. You may get electric shock or burned.
- When the unit is operating, keep your hands and face away from it, you may get injured by an accident.
- This power supply is primarily designed and manufactured to be used and enclosed in other equipment. Stick the WARNING label for users on the system equipment and describe the notice in the instruction manual.
- Never operate the unit under over current or shorted conditions for long time, which could result in damage or insulation failure. There is no possibility for fire or burning.
- Confirm connections to input/output terminals are correct as indicated in the instruction manual.
- Do not use the product in the environment with strong electromagnetic field, corrosive gas and conductive substance.

Note : CE MARKING

CE Marking, when applied to a product covered by this handbook, indicates compliance with the low voltage directive (73/23/EEC) as modified by the CE Marking Directive (93/68/EEC) which complies with EN60950

Notes for HWS30-150/ME IEC/EN/UL60601-1

⚠ Notes

- The product should be completely enclosed in the application according to the specifications, and contact to the I/O part with the patient be limited. Be careful when designing the out-line. Please refer to section 16, IEC/EN/UL60601-1.
- This product is not suitable for the use of the combustible narcotic that oxygen or the nitrous oxide mixed.
- It is necessary to fuse it in two poles of the main power supply in the overall equipment into which this product is built excluding the permanent installation type equipment defined by IEC/EN/UL60601-1 section 57.6. The fuse is installed in the monopole of the input of this product (live line).
- Between I/O of this product is evaluated as the basic insulation by IEC/EN/UL60601-1. Please add further insulation for safe contact to the output part.
- Please refer to local regulations for the disposal of the product that passes the life.
- The leakage current of this product in normal condition is 500uA or less. (At input voltage 230VAC.) The unit is suitable for medical equipment as provided by IEC/EN/UL60601-1. In the application according to the UL60601 requirement, it is assumed that surfaces of all equipment is assembled with the insulating materials.
- This product is not evaluated by IEC/EN/UL60601-1-2(EMC). However, EMC test data is available at Densai-Lambda.

HWS

1. Terminal Explanation

1 HWS15, HWS30, HWS50

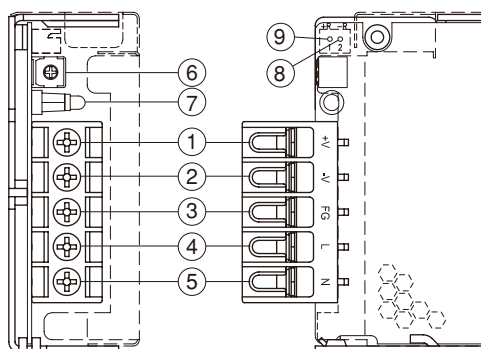

- ① + V : + Output terminal
(Standard type: 10A max./terminal)
- ② - V : - Output terminal
(Standard type: 10A max./terminal)
- ③ FG: Frame Ground
- ④ L : Input terminal Live line (Fuse in line)
- ⑤ N : Input terminal Neutral line
- ⑥ Output voltage adjustment trimmer
- ⑦ Output monitoring indicator (Green LED)

HWS50/R * (Option)

- ⑧ - R : Remote ON/OFF control (HWS50: Option)
- ⑨ + R : Remote ON/OFF control (HWS50: Option)

Connector (JST) for Remote ON/OFF control

| Connector | Housing | Terminal Pin |
|----------------|---------|--------------------------------|
| B2B-XH-AM (LF) | XHP-2 | BXH-001T-P0.6 or SXH-001T-P0.6 |

2 HWS80, HWS100, HWS150

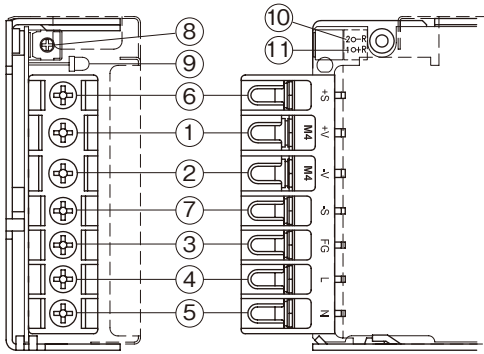

- ① + V: +Output terminal
(30A max./terminal, M4 screw)
- ② - V: -Output terminal
(30A max./terminal, M4 screw)
- ③ FG: Frame Ground
- ④ L: Input terminal Live line (Fuse in line)
- ⑤ N: Input terminal Neutral line
- ⑥ + S: +Remote sensing terminal
- ⑦ - S: -Remote sensing terminal
- ⑧ Output voltage adjustment trimmer
- ⑨ Output monitoring indicator (Green LED)

HWS80/R*, HWS100/R*, HWS150/R* (Option)

- ⑩ - R: Remote ON/OFF control (Option)
- ⑪ + R: Remote ON/OFF control (Option)

* Connector (JST) for Remote ON/OFF control

| Connector | Housing | Terminal Pin |
|----------------|---------|--------------------------------|
| B2B-XH-AM (LF) | XHP-2 | BXH-001T-P0.6 or SXH-001T-P0.6 |

HWS

2. Terminal connecting method

- Input must be off when making connection.
- Connect FG terminal to ground terminal of the equipment.
- The output load line and input line shall be separated and twisted to improve noise sensitivity.
- Remote sensing lines shall be twisted or use shielded wire.
- Remote ON/OFF control lines shall be twisted or use shielded wire.
- Use the output connector specified in outline drawing. Also, use recommended crimping tool.

HWS15, HWS30, HWS50

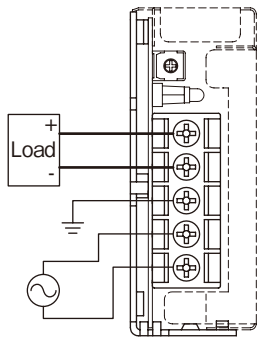

HWS80, HWS100, HWS150

Basic connection (Local sensing)

Connect "+S" terminal to "+V" terminal, and "-S" terminal to "-V" terminal with the attached short pieces.

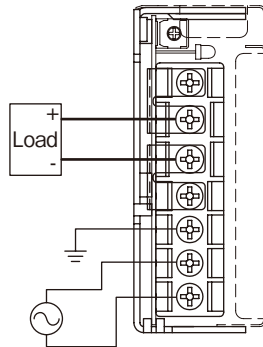

Remote sensing connection

Connect "+S" terminal to "+V" terminal of load, and "-S" terminal to "-V" output terminal of load with wires. When remote sensing terminals are opened, output is shut down.

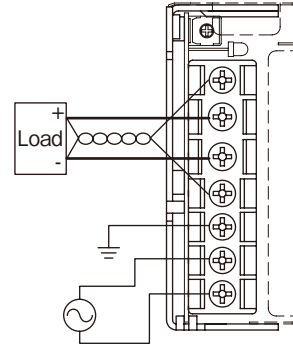

3. Explanation of Functions and Precautions

1 Input Voltage Range

Input voltage range is single phase 85-265VAC (47-63Hz) or 120-370VDC. Input voltage which is out of specification may cause unit damage. For cases where conformance to various safety specs (UL, CSA, EN) are required, to be described as 100-240VAC (50/60Hz).

2 Output Voltage Range

V.ADJ trimmer on the front panel side can adjust the output voltage within the range. Output voltage range is

within +/- 20% (3.3V: +20% /-10% , 48V: +10%/-20%) of nominal output voltage. To turn the trimmer clockwise, the output voltage will be increased. Note over voltage protection (OVP) function may trigger if the output voltage is increased excessively.

3 Inrush Current

This series uses Power Thermistor to protect the circuit from Inrush Current. Please carefully select input switch and fuse in cases of the high temperature and the power re-input.

4 Over Voltage Protection (OVP)

The OVP function (inverter shut down method, manual reset type) is provided. When OVP triggers, the output will be shut down. The input shall be removed for a few minutes, and then re-input for recovery of the output. OVP setting shall be fixed and not to be adjusted externally. Never apply more than rated output voltage to output terminal, which may lead damage. In the case of inductive load, use decoupling diode at output line.

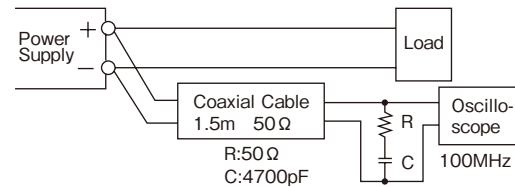

5 Over Current Protection (OCP)

Constant current limiting and Hiccup (except HWS15, HWS30, which characterized fold back), automatic recovery. OCP function operates when the output current exceeds 105% of maximum output current on specification. The output will automatically recovered when the overload condition is canceled. Never operate the unit under over current or shorted conditions for more than 30 seconds, which could result in damage.

6 Remote Sensing (+S, -S terminal) (For HWS80, HWS100, HWS150)

This function compensates voltage drop of wiring from output terminals to load terminals. Connect "+S" terminal to "+V" terminal of load and "-S" terminal to "-V" terminal of load with sensing wires. The total line voltage drop (+ side line and - side line) shall be less than 0.3V. In case that sensing line is too long, it is necessary to put an electrolytic capacitor in following 3 places;

- 1) Across the load terminal,
- 2) Between "+S" terminal and "+V" terminal,
- 3) Between "-S" terminal and "-V" terminal.

If remote sensing terminals are opened, the output will rise and OVP may be triggered.

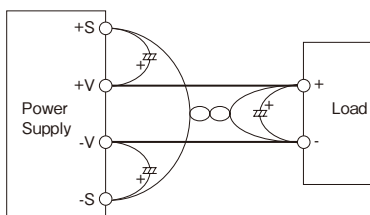

7 Output Ripple & Noise

The standard specification for maximum ripple value is measured according to measurement circuit specified by JEITA RC-9131A. When load lines are longer, ripple will become larger. In this case, electrolytic capacitor, film capacitor, etc. might be necessary to use across the load terminal. The output ripple cannot be measure accurately if the probe ground lead of oscilloscope is too long.

For start up at low ambient temperature and low voltage, output ripple noise of HWS15, HWS30 might not meet specification. However, there is no overshoot at start up and output ripple noise specification can be met after one second.

8 Series Operation

For series operation, either method (A) or (B) is possible.

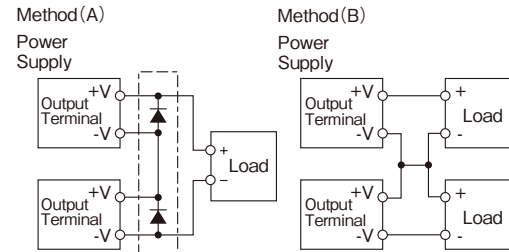

Note : In case of (A), please connect diodes to prevent the reverse voltage.

9 Parallel Operation

- (A) Operation to increase the Output Current is not possible.
- (B) Operation as a Backup Power Supply is possible as follows.
 1. Set the power supply output voltage higher by the amount of forward voltage drop (VF) of the diode.
 2. Please adjust the output voltage of each power supply to be the same.
 3. Please use within the specifications for output voltage and output current.

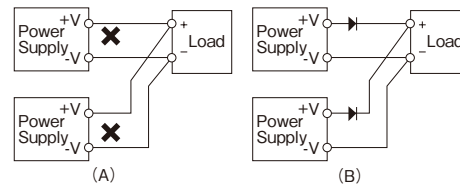

10 Remote ON/OFF Control (HWS50 - 150 Optional Spec.)

Remote ON/OFF control function is available as option with model name followed by /R. Using this function allows the user to turn the output on and off without having to turn the AC input on and off. It is controlled by the voltage applied to +R and -R. This circuit is in the Secondary (output) side of the power supply unit. Do not connect in the Primary (input) side. And this circuit is isolated from the output by a photocoupler.

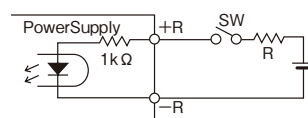

The control mode is shown below.

| + R & - R terminal condition | output condition | External voltage level: E | External resistance: R |
|------------------------------|------------------|---------------------------|------------------------|
| SWON (Higher than 4.5V) | ON | 4.5 ~ 12.5VDC | No required |
| SWOFF (Lower than 0.8V) | OFF | 12.5 ~ 24.5VDC | 1.5kΩ |

11 Isolation Test

Isolation resistance between output and FG shall be more than 100MΩ at 500VDC. For safety, voltage setting of DC isolation tester must be done before the test. Ensure that it is fully discharged after the test.

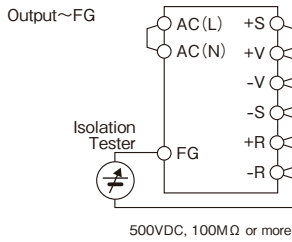

12 Withstand Voltage

This series is designed to withstand 3.0kVAC between input and output, 2.0kVAC between input and FG and 500VAC between output and FG each for 1 minute. When

testing withstand voltage, set current limit of withstand voltage test equipment at 20mA (Output-FG : 100mA). The applied voltage must be gradually increased from zero to testing value and then gradually decreased for shut down. When timer is used, the power supply may be damaged by high impulse voltage at timer switch on and off. Connect input and output as follows.

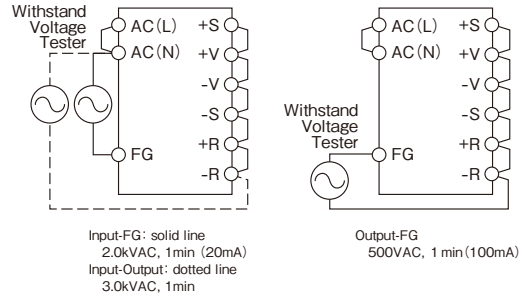

HWS

4. Mounting Directions

1 Output Derating according to the Mounting Directions

Recommended standard mounting is method (A). Method (B), (C) and (D) are also possible. Refer to the derating below. Please do not use installation method (E), where the PCB will be on the topside and heat will be trapped inside the unit. In the following derating curve, the maximum output current is considered to be 100% .

Standard Mounting (A)

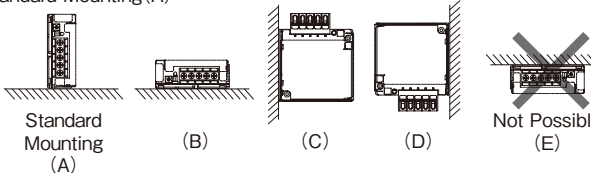

Output Derating
(A) Standard Mounting Direction (Open frame)

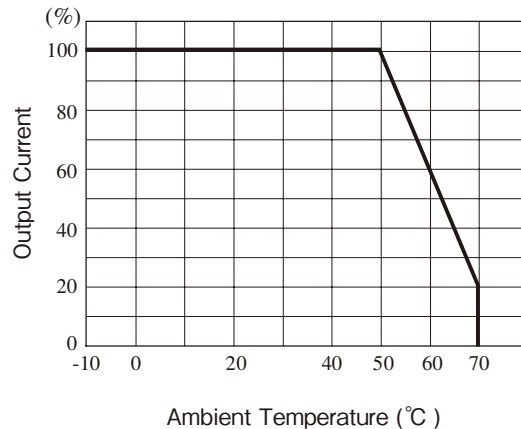

Open Frame (Without Cover)

| Model | HWS15 | | | | HWS30 | | | | HWS50 | | | | HWS80, HWS100 | | | | HWS150 | | | |
|-------------------------|-------|-----|-----|-----|-------|-----|-----|-----|-------|-----|-----|-----|---------------|-----|-----|-----|--------|-----|-----|-----|
| | A | B | C | D | A | B | C | D | A | B | C | D | A | B | C | D | A | B | C | D |
| Amb. Temp. -10 to +30°C | 100 | 100 | 100 | 100 | 100 | 100 | 100 | 100 | 100 | 100 | 100 | 100 | 100 | 100 | 100 | 100 | 100 | 100 | 100 | 100 |
| 40°C | 100 | 100 | 100 | 100 | 100 | 100 | 100 | 100 | 100 | 100 | 100 | 100 | 100 | 100 | 100 | 100 | 100 | 100 | 90 | 90 |
| 50°C | 100 | 100 | 100 | 100 | 100 | 100 | 100 | 100 | 100 | 100 | 60 | 60 | 100 | 80 | 80 | 80 | 100 | 80 | 80 | 80 |
| 60°C | 60 | 60 | 60 | 60 | 60 | 60 | 60 | 60 | 60 | 60 | 20 | 20 | 60 | 60 | 60 | 60 | 60 | 60 | 60 | 60 |
| 70°C | 20 | 20 | 20 | 20 | 20 | 20 | 20 | 20 | 20 | 20 | - | - | 20 | 20 | 20 | 20 | 20 | 20 | 20 | 20 |

With Cover (/RA Option)

| Model | HWS15 | | | | HWS30 | | | | HWS50 | | | | HWS80, HWS100 | | | | Model | HWS150 | | | |
|-------------------------|-------|-----|-----|-----|-------|-----|-----|-----|-------|-----|-----|-----|---------------|-----|-----|-----|--------------|------------|-----|-----|-----|
| | A | B | C | D | A | B | C | D | A | B | C | D | A | B | C | D | | Amb. Temp. | A | B | C |
| Amb. Temp. -10 to +30°C | 100 | 100 | 100 | 100 | 100 | 100 | 100 | 100 | 100 | 100 | 100 | 100 | 100 | 100 | 100 | 100 | -10 to +25°C | 100 | 100 | 100 | 100 |
| 40°C | 100 | 100 | 100 | 100 | 100 | 100 | 100 | 100 | 100 | 100 | 60 | 60 | 100 | 80 | 80 | 80 | 40°C | 100 | 76 | 76 | 76 |
| 50°C | 60 | 60 | 60 | 60 | 60 | 60 | 60 | 60 | 60 | 60 | 20 | 20 | 60 | 60 | 60 | 60 | 50°C | 60 | 60 | 60 | 60 |
| 60°C | 20 | 20 | 20 | 20 | 20 | 20 | 20 | 20 | 20 | 20 | - | - | 20 | 20 | 20 | 20 | 60°C | 20 | 20 | 20 | 20 |

2 Mounting Method

(1) This is convection cooling type power supply. In the consideration for the heat radiation and safety. Please take a distance more than 15mm between the power supply and the peripheral parts. When lining up multiple units, please make sure to place them 15mm or more apart from each other.

Be sure to insert the insulating spacer (MIN 5mm) on the component side of without-cover models.

(2) The maximum allowable penetration of mounting screws is 6mm.

(3) Recommended torque for mounting screw
 HWS15-150 (M3 screw) : 0.49N·m (5.0kgf·cm)

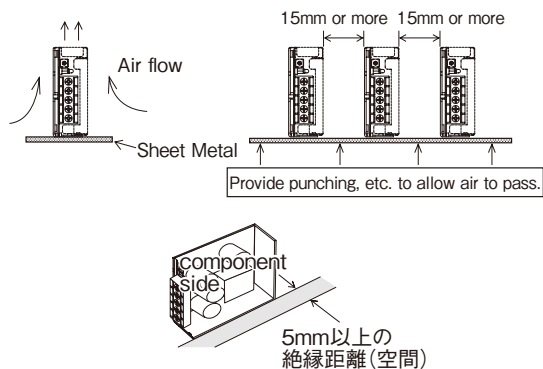

HWS

5. Wiring Method

- The output load line and input line shall be separated and twisted to improve noise sensitivity.
- The sensing lines shall be twisted and separated from the output lines.
- Use all lines as thick and short as possible to make lower impedance.
- Noise can be eliminated by attaching a capacitor to the load terminals.
- In HWS15-50, the output current of each output terminal is limited to 10A.
- In HWS80-150, the output current of each output terminal is limited to 30A.
- For safety and EMI considerations, connect the FG terminal of HWS15-150 to mounting set ground terminal.
- The recommended wire type :

| MODEL | Recommended wire | Recommended torque | Recommended crimp-type terminal | | |
|------------|------------------|---|---------------------------------|---------|----------------------|
| | | | D (MAX) | t (MAX) | Mounting piece (MAX) |
| HWS15 - 50 | AWG14-22 | M3.5 Screws 1.0N·m (9.8kgf·cm) - 1.4N·m (13.7kgf·cm) | 6.8mm | 0.8mm | 2 pieces |
| HWS80,100 | AWG12-22 | M4 Screws 1.2N·m (11.8kgf·cm) - 1.6N·m (15.6kgf·cm) | 8.1mm | 1.0mm | 1 piece |
| | AWG12-22 | | | 0.8mm | 2 pieces |
| HWS150 | AWG14-22 | M3.5 Screws 1.0N·m (9.8kgf·cm) - 1.4N·m (13.7kgf·cm) | 6.8mm | 0.8mm | 2 pieces |
| | AWG10-22 | M4 Screws 1.2N·m (11.8kgf·cm) - 1.6N·m (15.6kgf·cm) | 8.1mm | 1.0mm | 1 piece |
| | AWG10-22 | | | 0.8mm | 2 pieces |
| | AWG14-22 | M3.5 Screws 1.0N·m (9.8kgf·cm) - 1.4N·m (13.7kgf·cm) | 6.8mm | 0.8mm | 2 pieces |

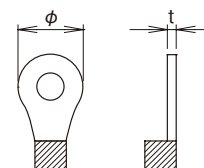

Note 1 : When using separate loads, use of two pcs. of 0.8mm thick crimp-type terminal is recommended.
 Note 2 : For recommended diameter, refer to wire maker recommended allowable current and voltage drop.
 Especially, for 3V or 5V models, output current is large. Thick diameter wire is recommended.

6. External Fuse Rating

Refer to the following fuse rating when selecting the external fuses that are to be used on input line. Surge current flows when line turns on. Use slow-blow fuse or time-lag fuse. Do not use fast-blow fuse. Fuse rating is specified by in-rush current value at line turn-on. Do not select the fuse

according to input current (rms.) values under the actual load condition.

HWS15, HWS50: 2A HWS30, HWS80, HWS100: 3.15A
HWS150: 5A

7. Before concluding that the unit is at fault...

Before concluding that the unit is at fault, make the following checks.

- Check if the rated input voltage is connected.
- Check if the wiring of input and output is correct.
- Check if the wire size is not too thin.
- Check if the output voltage control (V.ADJ) is properly adjusted.
- Check if the Remote ON/OFF control connector is not opened, when use Remote ON/OFF control function.
- Check if the output current and output wattage dose not exceed specification.

- Audible noise can be heard during Dynamic-Load operation.
- Audible noise can be heard when input voltage waveform is not sinusoidal wave.
- Ensure that a large capacitor is not connected on the output side. Please use within maximum capacitance shown below.

HWS

| MODEL | Maximum external capacitance | | | | | |
|-----------------------|------------------------------|----|---------|---------|---------|---------|
| | 3.3V | 5V | 12V | 15V | 24V | 48V |
| HWS15 | 10,000uF | | 5,000uF | 2,000uF | 1,000uF | 500uF |
| HWS30, HWS50 | 10,000uF | | 5,000uF | | 2,000uF | 500uF |
| HWS80, HWS100, HWS150 | 10,000uF | | | | 5,000uF | 1,000uF |

8. Range of free warranty

Conditions of usage at the free of charge warranty are as follows.

- Average operating temperature (ambient temperature of the power supply unit) is under 40°C.
- Average load factor is 80% or less.
- Installation method : Standard installation.

However, the maximum rating is within the output derating.

Following cases are not covered by warranty.

- Improper usage like dropping products, applying shock and defects from operation exceeding specification of the units.
- Defects resulting from natural disaster (fire, flood).
- Unauthorized modifications or repair by the buyers defects not cause by DENSEI LAMBDA.

HWS300, 600 Series Instruction Manual

BEFORE USING THE POWER SUPPLY UNIT

Be sure to read the following precautions thoroughly before using this power supply unit.

Pay attention to all warnings and cautions before using the unit. Incorrect usage could lead to an electric shock, damage or a fire hazard.

WARNING

- Do not make unauthorized changes to power supply unit, otherwise you may have electric shock and void warranty.
- Do not touch the internal components, they may have high voltage or high temperature. You may get electric shock or burned.
- When the unit is operating, keep your hands and face away from it; an accident may injure you.
- Do not use unit under unusual condition such as emission of smoke or abnormal smell and sound etc. It might cause fire and electric shock.
In such case, please contact us; do not repair by yourself, as it is dangerous for the user.
- Do not drop or insert anything into unit. It might cause failure and fire, when using the unit under such condition.
- Do not operate these units at the condition of condensation. It may cause fire and electric shock.
- The outputs of these products must be earthed in the end use equipment to maintain SELV.
If the outputs are not earthed, they must be considered hazardous and must not be made user accessible.

CAUTION

- This power supply is primarily designed and manufactured to use and enclose in other equipment.
- This power supply unit has a built-in fan for air-cooling. Do not block air intake and exhaust. It might cause fire.
- Input voltage, output current, output power, ambient temperature and ambient humidity should be within specifications, otherwise the unit will be damaged.
- The unit might be broken down by accident or unexpected situation. For application equipment, which requires very high reliability (nuclear related equipment, traffic control equipment, medical equipment, etc.), please provide fail safety function in the equipment.

- Do not make an improper wiring to input and output terminals. It may cause damage.
- Do not use in environment such as strong electromagnetic field, erosive gas etc, or any environment where conductive foreign substance may enter.
- Do not operate and store this unit at the condition of condensation. In such case, waterproof treatment is necessary.
- Do not operate this unit after it falls down.
- The output voltage of this power supply is considered to be a hazardous energy level, and must not be accessible to an operator.

Notes for HWS30-150/ME IEC/EN/UL60601-1

NOTES

- The product should be completely enclosed in the application according to the specifications, and contact to the I/O part with the patient be limited. Be careful when designing the outline. Please refer to section 16, IEC/EN/UL60601-1.
- This product is not suitable for the use of the combustible narcotic that oxygen or the nitrous oxide mixed.
- The signal port connects only the device that suits IEC/EN/UL60601-1.
- It is necessary to fuse it in two poles of the main power supply in the overall equipment into which this product is built excluding the permanent installation type equipment defined by IEC/EN/UL60601-1 section 57.6. The fuse is installed in the monopole of the input of this product (live line).
- Between I/O of this product is evaluated as the basic insulation by IEC/EN/UL60601-1. Please add further insulation for safe contact to the output part.
- Please refer to local regulations for the disposal of the product that passes the life.
- The leakage current of this product in normal condition is 500uA or less. (At input voltage 230VAC.) The unit is suitable for medical equipment as provided by IEC/EN/UL60601-1. In the application according to the UL60601 requirement, it is assumed that surfaces of all equipment is assembled with the insulating materials.
- This product is not evaluated by IEC/EN/UL60601-1-2(EMC). However, EMC test data is available at Densai-Lambda.

HWS

1. Terminal Explanation

Please pay extra attention to the wiring. Incorrect connection will damage the power supply.

1 Front Panel Explanation

● HWS300

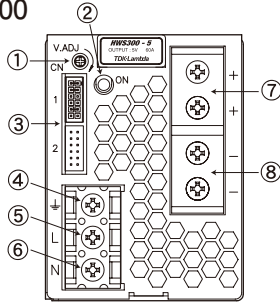

● HWS600

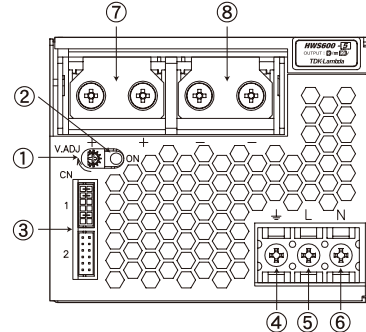

- ① V.ADJ: Output voltage adjustment trimmer.
(The output voltage rises when a trimmer is turned clockwise.)
- ② ON: Output (Power On) indication LED
(The indicator turns on when the power supply output is in normal operating condition.)
- ③ CN1, CN2: Remote sensing, ON/OFF control signal, Current balance signal, Power fail signal, Output voltage external control signal. (Refer to 2-2.)

- ④ ⊥ : Protective Earth (Frame ground), M4 screw.
- ⑤ AC input terminal L: Live Line (Fuse in line), M4 screw.
- ⑥ AC input terminal N: Neutral line, M4 screw.
- ⑦ +: + Output terminal
(HWS300: M4 screw x 2 / HWS600: M5 screw x 2)
- ⑧ -: - Output terminal
(HWS300: M4 screw x 2 / HWS600: M5 screw x 2)

2 CN1, CN2 Connector pin Configuration and Function

CN1 and CN2 are same pin configuration and function. They are connected to each other in this power supply unit. When the pin of CN1 side is shorted, the same function pins of CN2 side are also shorted. Please note that the function cannot be separately set with CN1 and CN2.

| Pin No | Configuration | Function |
|--------|---------------|--|
| 1 | + Vm | +Output monitor terminal. Connected to +Output terminal in this Power supply unit. (+Vm terminal can not supply load current.) |
| 2 | + S | Remote sensing terminal for +output. (For remote sensing function, which compensates for line drop between power supply terminals and load terminals. Connect to +Vm terminal when remote sensing function unnecessary.) |
| 3 | - Vm | -Output monitor terminal. Connected to -Output terminal in this Power supply unit. (-Vm terminal can not supply load current.) |
| 4 | - S | Remote sensing terminal for -output. (For remote sensing function, which compensates for line drop between power supply terminals and load terminals. Connect to -Vm terminal when remote sensing function unnecessary.) |
| 5 | PC | Current balance terminal. (For output current balancing in parallel operation.) |
| 6 | COM | GND for PC and PV signals. |
| 7 | PV (Optional) | Output voltage external control terminal. (For power supply output voltage control with an external voltage. Standard models don't have this function and indicate NC mark at panel.) |
| 8 | NC | No connect |
| 9 | CNT | Remote ON/OFF control terminal. (Power supply ON/OFF control with an external signal.) |
| 10 | TOG | GND for CNT and PF signals. (Same as Pin No.12) |
| 11 | PF | Power fail signal (PF signal) output terminal. (As the output voltage drops, or FAN stops and AC input voltage down, "Power Fail" terminal will output "High". |
| 12 | TOG | GND for CNT and PF signals. (Same as Pin No.10) |

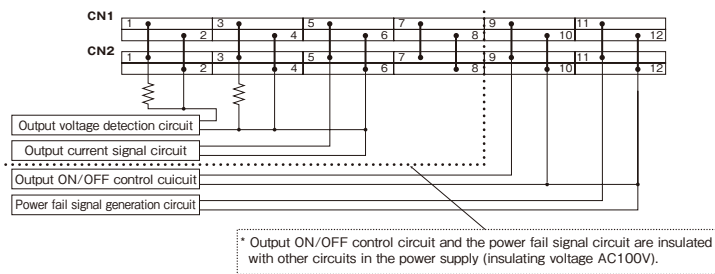
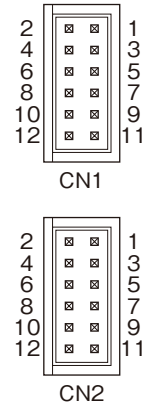

* Output ON/OFF control circuit and the power fail signal circuit are insulated with other circuits in the power supply (insulating voltage AC100V).

CN1, CN2 Connector & Housing & Terminal Pin

| PART DESCRIPTION | PART NAME | MANUFACT |
|--------------------|--|----------|
| PIN HEADER | S12B-PHDSS | JST |
| SOCKET HOUSING | PHDR-12VS | JST |
| TERMINAL PINS | SPHD-002T-P0.5 (AWG28-24) SPHD-001T-P0.5 (AWG26-22) | JST |
| HAND CRIMPING TOOL | YRS-620 (SPHD-002T-P0.5) YC-610R (SPHD-001T-P0.5) | JST |

2. Terminal Connection Method

Please pay extra attention to the wiring. Incorrect connection will damage the power supply.

- When connecting input and output wiring, and CN1, CN2, input AC-Line should be off.
- Input wiring and output wiring shall be separated to improve noise sensibility.
- The protective earth (PE) must be connected to the \perp terminal or chassis.

- Remote sensing lines shall be twisted or used with shielded wired.
- Remote ON/OFF control lines shall be twisted or used shielded wires. Separate from load line.
- Output current of each terminal screw shall be less than 40A for HWS300. And shall be less than 60A for HWS600.

HWS300 Panel Side (Common HWS600)

Basic connection (Local sensing)

Connect "+S" terminal to "+Vm" terminal and "-S" terminal to "-Vm" terminal. Connect "CNT" terminal to "TOG" terminal with the attached connector.

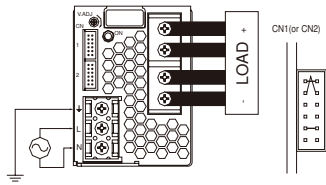

Remote sensing required

Connect "+S" terminal to "+" terminal of load and "-S" terminal to "-" output terminal of load with wires.

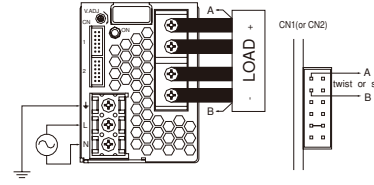

Attached connector when shipping

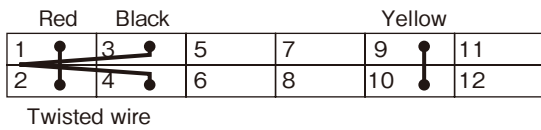

Connecting circuit with CN1 or CN2 connector

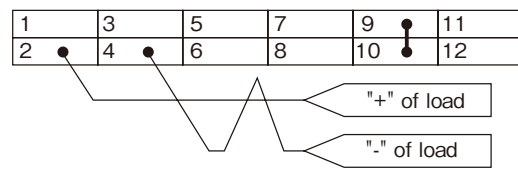

ON/OFF control required

"TOG" terminal is ground for "CNT" terminal.

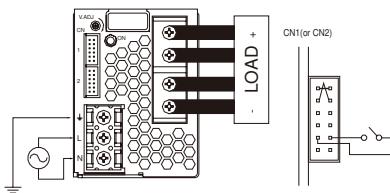

PF signal output required

Open collector method shown below shall be used. "TOG" terminal is ground for "PF" terminal.

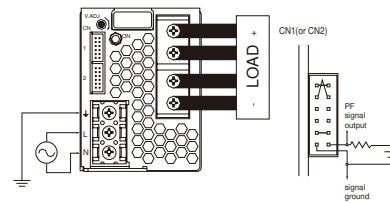

Connecting circuit with CN1 or CN2 connector

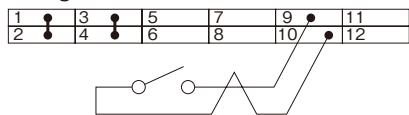

Connecting circuit with CN1 or CN2 connector

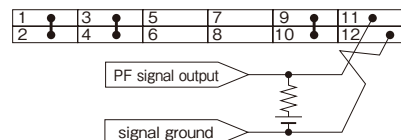

3. Functions and Precautions

1 Input Voltage Range

Input voltage range is single phase 85-265VAC (47-63Hz) or 120-330VDC. Input voltage, which is out of specification, may cause unit damage. Rated input voltage for safety standard application is 100VAC-240VAC (50/60Hz).

2 Output Voltage Range

Output voltage is set to the rated value at shipment. V.ADJ trimmer on the front panel side may be used to adjust the output voltage within the range specified.

Output voltage range is within $\pm 20\%$ of rated output voltage (48V Output Model: -20% to +10%).

To turn the trimmer clockwise, the output voltage will be increased. Take note when the output voltage is increased excessively, over voltage protection (OVP) function may trigger and output voltage will be shut down.

3 Over Voltage Protection (OVP)

The OVP function (inverter shutdown method, manual reset type) is provided. OVP function operates within 125-145% of the rated output voltage value (48V type: 115-135%), and the output will be shut down when OVP function triggers. To reset OVP, remove the input of power supply for a few minutes, and then re-input. Or, use CNT reset (remote ON/OFF: OFF to ON). OVP value is fixed and not to be adjusted externally.

Never apply more than rated output voltage to output terminal, which may lead damage. In the case of inductive load, use decoupling diode at output line.

4 Over Current Protection (OCP)

The OCP function is provided. OCP characteristic is constant current limiting, (less than 5V output model: with Hiccup operation) automatic recovery. OCP function operates when the output current exceeds 105% (24V output model: 119%) of maximum DC output current specification. The output will be automatically recovered when the overload condition is canceled. Never operate the unit under over current or shorted conditions for more than 30 seconds, which may lead damage. OCP setting is fixed and not to be adjusted externally.

5 Over Temperature Protection (OTP)

The OTP function (manual reset type) is provided. When ambient or internal temperature rises abnormally, OTP function operates and output will be shut down. After shut down, remove the input and cool it down to reset OTP.

Then re-input.

6 Low Output Detection Circuit (PF)

Low output voltage detection circuit is provided. Power Fail (PF) signal will turn "High" level to indicate the abnormal status

when the output voltage becomes within 65-80% of rated value caused by either the drop or brownout of the input voltage or OCP, OVP and OTP function operation. When the built-in FAN motor of this power supply unit stops, PF signal will turn to "H". The PF signal is isolated from input and output by a photo-coupler. It uses the open collector method shown below.

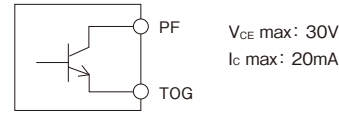

7 Remote Sensing (+S, -S terminal)

This function compensates voltage drop of wiring from output terminals to load terminals. Connect "+S" terminal to "+" terminal of load and "-S" terminal to "-" terminal of load with sensing wires. The total line voltage drop (+ side line and - side line) shall be less than 0.3V. In case that sensing lines are too long, it is necessary to put an electrolytic capacitor in following 3 places;

- 1) across the load terminal,
- 2) between "+S" terminal and "+" terminal,
- 3) between "-S" terminal and "-" terminal.

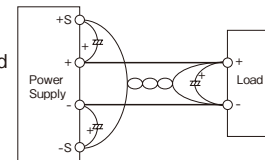

When the function of remote sensing is not used, connect +S terminal to +Vm terminal, and -S terminal to -Vm terminal by the attachment connector.

If remote sensing terminals are opened, the stability and the accuracy of the output deteriorated. Therefore, terminal +S, -S must be connected.

8 Remote ON/OFF Control

Remote ON/OFF control is provided.

Using this function, output on/off is allowed to control without input voltage on/off. The output is turned to ON when TOG and CNT terminals are shorted, and the output is turned to OFF when these terminals are opened. When the function is not used, connect TOG and CNT terminals. The standards for this function are as follows. "TOG" terminal is return for "CNT" terminal.

- (1) TTL compatible. The maximum input voltage to CNT terminal is 12V, and the maximum allowable reverse voltage is -1V. The sink current for CNT terminal is 3.5mA.
- (2) A switch and relay or a transistor can be used as ON/OFF switch.
- (3) Remote ON/OFF control circuit is isolated from the input and output by a photo-coupler and can be controlled regardless of the output potential (+ or -). Connect TOG terminal to ground of control signal.

The mode of control

| CNT Level for TOG Terminal | Output | Built-in Fan |
|----------------------------|--------|--------------|
| Short or L (0V - 0.8V) | ON | Rotate |
| Open or H (2.4V - 12V) | OFF | Stop |

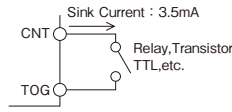

9 Output Ripple & Noise

The standard specification for maximum ripple value is measured specified measurement circuit (JEITA-RC9131A). When load lines are longer, ripple becomes larger. In this case, electrolytic capacitor, film capacitor, etc. might be necessary to use across the load terminal. The output ripple cannot be measured accurately if the probe ground lead of oscilloscope is too long.

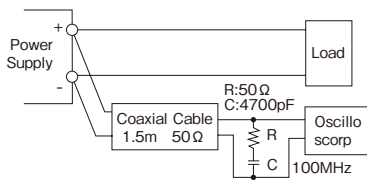

10 Series Operation

For series operation, both method (A) and (B) are possible. There might be a step in the output rise waveform during series operation.

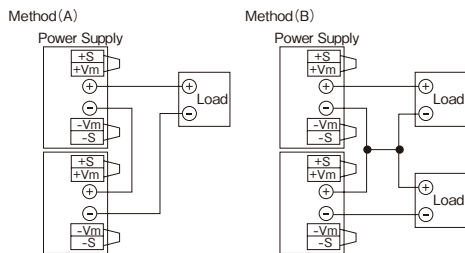

11 Parallel Operation

Current balancing function is provided. Both operations mode (A) and (B) are possible.

- (A) To Increase the Output Current
 - Correct PC to PC terminal and COM to COM terminal, the current balancing function activates and output current of each power supply is equivalently supplied to load. Wires to PC terminals, COM terminals shall be as short as possible and same length and twisted.
 - 1. Adjust the output voltage of each power supply to be same value within 1% or 100mV whichever is smaller.
 - 2. Use same length and type of wires for all load lines.
 - 3. Use the power supply within the rated output current for all paralleled models.
 - 4. Parallel operation is possible up to 5 units.
- (B) To Use as a Backup Power Supply
 - 1. Adjust the output voltage of each power supply to be same value.
 - 2. Set power supply output voltage higher by the forward voltage drop of diode.
 - 3. Use within the specifications for output voltage and output current.

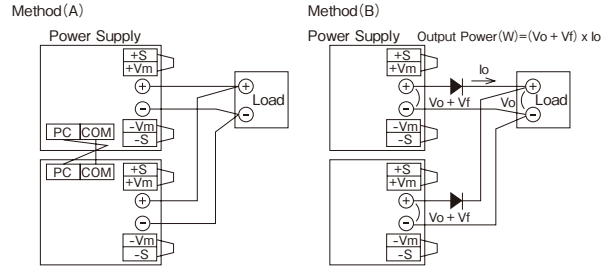

12 Isolation Test

Isolation resistance between output and \perp (chassis) shall be more than 100MΩ at 500VDC and between output and CNT·PF shall be more than 10MΩ at 100VDC. For safety operation, voltage setting of DC isolation tester must be done before the test. Ensure that it is fully discharged after the test.

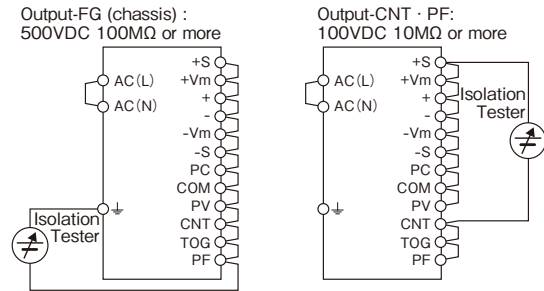

13 Withstand Voltage

This series is designed to withstand 3.0kVAC between input and output, 2.5kVAC between input and \perp (chassis), 500VAC between output and \perp (chassis), and 100VAC between output and CNT·PF terminal each for 1 minute. When testing withstand voltage, set current limit of withstand voltage test equipment at 20mA.

(Output- \perp (chassis) and Output-Control: 100mA). The applied voltage must be gradually increased from zero to testing value and then gradually decreased for shut down. When timer is used, the power supply may be damaged by high impulse voltage at timer switch on and off. Connect input and output as follows.

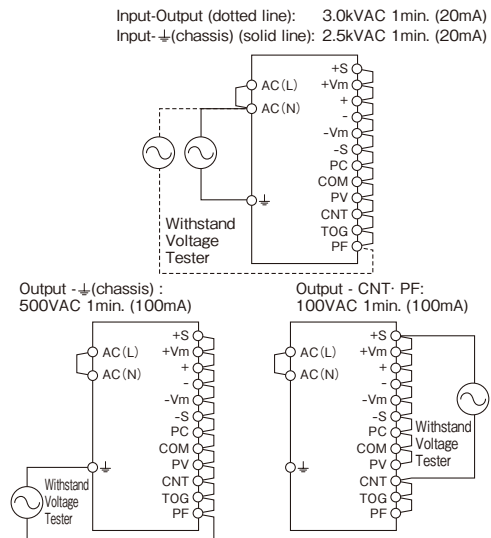

*This product have monolithic ceramic capacitor in secondary circuit to frame ground. Some of the withstand voltage tester may generate high voltage at the matching with monolithic ceramic capacitor and may cause the unit damage.

So, please check the waveform of test voltage.

14 Output Voltage External Control(PV)

Output voltage external control function is available as option with model name followed by "/PV". Output voltage can be varied by applying an external voltage (1-6V) to "PV" terminal and "COM" terminal. Note if an external voltage is not applied, there will be no output. And if the below connection method is attempted with the standard models internal components could be damaged. Please consider the following characteristics.

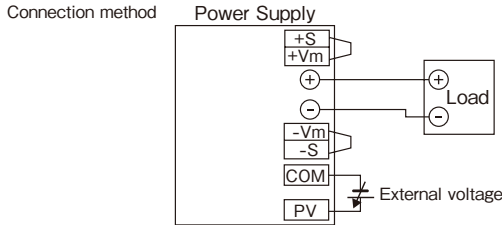

Output Voltage Linearity

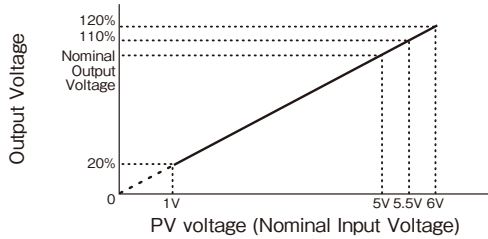

Output Voltage Derating

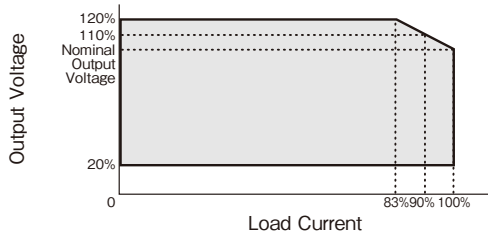

Note 1. Regarding output voltage adjustment below 20%, please consult our sales.

Note 2. For 48V output model only, spaces below must be followed. Limit output voltage variation range at 20% -110% . At PV voltage variation 1V-5.5V.

15 Output Peak Current

For 24V output model, please meet the following condition. Reduce peak current value according to output derating as section 5-1.

- Input Voltage range: AC180V-265V
- Continuous Peak output time (τ): Within 10 seconds
- Peak output current (I_p): Within the rated peak output current
- Average DC output current (I_m): Within the rated output current

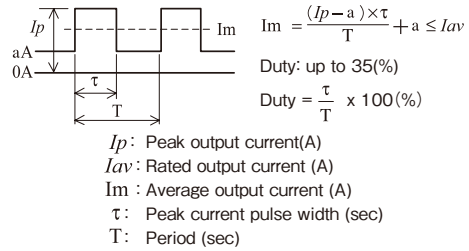

4. Mounting Directions

1 Output Derating according to the Mounting Directions

Recommended standard mounting method is (A). Method (B) is also possible. Refer to the derating below.

HWS300

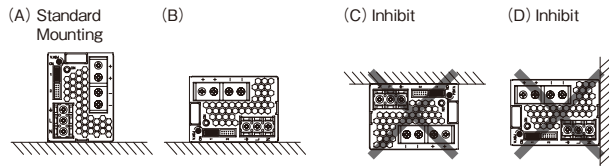

HWS600

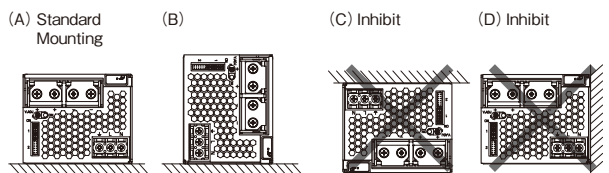

2 Output Derating

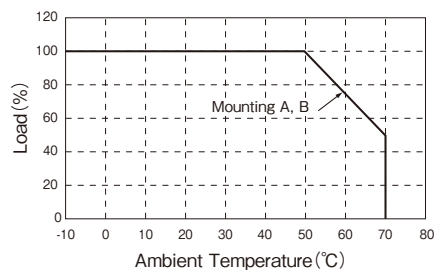

| Ta (°C) | Load (%) | |
|------------|--------------|--------------|
| | Mounting (A) | Mounting (B) |
| -10 to +50 | 100 | |
| +70 | 50 | |

3 Mounting Method

- (1) Forced air cooling type power supply.
This power supply has ventilating holes on the front and back side panels. Keep these two areas freely as much as possible.
- (2) The maximum allowable penetration is 6mm.
Incomplete thread of mounting screw should not be penetrated.
- (3) Recommended torque for mounting screw:
M4 screw: 1.27 N · m (13.0kgf · cm)

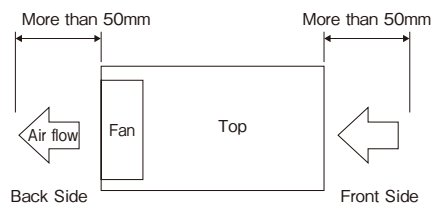

5. Wiring Method

- (1) The output load line and input line shall be separated to improve noise sensitivity.
- (2) The sensing lines shall be twisted and separated from the output lines for remote sensing.
- (3) Use all lines as thick and short as possible to make lower impedance.
- (4) Attaching a capacitor to the load terminals can eliminate noise.
- (5) For safety and EMI considerations, connect ⊥ terminal to the mounting set ground terminal.
- (6) Recommended torque for the terminal;
HWS600 Output terminal (M5 screw): 2.50 N · m (25.5kgf · cm)
HWS300 Input, Output terminal & HWS600 Input terminal (M4 screw): 1.27 N · m (13.0kgf · cm)

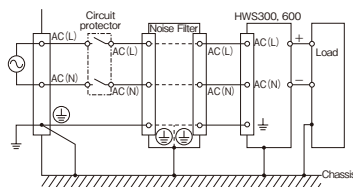

[The PHD connector manufacture method]

This product is using SPHD-001T-P0.5 or SPHD-002T-P0.5 connector made from JAPAN SOLDERLESS TERMINAL MFG CO LTD.

Regarding to manufacture of a connector, it becomes the regulation as following.

a). Applicable Wire and Crimping tool

Wire size is AWG#26-AWG#22 and insulation outer dia is φ 1.0-φ 1.5mm.

Appreciable wire per barrel size is UL1007 (standard wire) and its equivalent standard wire can be used.

Regarding the AWG#22, use UL1061 or its equivalent standard wire, because wire insulation outer diameter of UL1061 is samll. Crimping tool is as below.

| Crimping tool | Crimping applicator | Dies |
|----------------|-----------------------|-------------------------|
| AP-K2 or AP-KS | MKS-LS-10 or MKS-L-10 | SPHD-001-05/SPHD-002-05 |

b). Crimping Operation

The reference value of wire strip is 2.3mm. As wire strip length differs depending on type of wire and crimping method, decide the best wire strip length considering processing condition. When wire is stripped, do not damage or cut off wire conductors.

Table of crimp height

SPHD-001T-P0.5

| Wire | | Insulation O.D (mm) | Crimp height (mm) | |
|--------|---------|---------------------|-------------------|-----------------|
| Type | Size | | Conductor part | Insulation part |
| UL1007 | AWG #26 | 1.3 | 0.60 - 0.70 | 1.7 |
| UL1007 | AWG #24 | 1.5 | 0.65 - 0.75 | 1.8 |
| UL1061 | AWG #22 | 1.4 | 0.70 - 0.80 | 1.8 |

SPHD-002T-P0.5

| Wire | | Insulation O.D (mm) | Crimp height (mm) | |
|--------|---------|---------------------|-------------------|-----------------|
| Type | Size | | Conductor part | Insulation part |
| UL1007 | AWG #28 | 1.2 | 0.55 - 0.60 | 1.6 |
| UL1007 | AWG #26 | 1.3 | 0.60 - 0.65 | 1.7 |
| UL1007 | AWG #24 | 1.5 | 0.62 - 0.67 | 1.8 |

Note 1. Crimp height at wire barrel should be set to pre-determined dimensions.

Note 2. Adjust crimp height at wire insulation barrel to the extent that wire insulation is slightly pressed, and set it so that crimping is not excessivery.

Note 3. Crimping condition at wire insulation barrel is as below

Fig.1.
Note 4. For AWG#28, #26, #24, use UL1007 type. For AWG #22, use UL1061 type.

Fig.1



Good

Fig.2: Examples of defective crimping

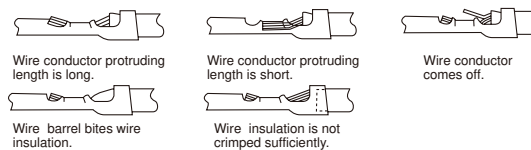

Check of crimping appearance visually for correct crimping as referring to above Fig.2

Check the tensile strength at crimped part when operation finishes.

Table of tensile strength at crimped part.

SPHD-001T-P0.5

| Wire size | Requirement N min. | Actual value N |
|---------------|--------------------|----------------|
| UL1007 AWG#26 | 20 | 39.2 - 45.1 |
| UL1007 AWG#24 | 30 | 68.6 - 74.5 |
| UL1007 AWG#22 | 40 | 92.1 - 96.0 |

SPHD-002T-P0.5

| Wire size | Requirement N min. | Actual value N |
|---------------|--------------------|----------------|
| UL1007 AWG#28 | 15 | 27.0 - 34.3 |
| UL1007 AWG#26 | 20 | 44.1 - 48.0 |
| UL1007 AWG#24 | 30 | 66.6 - 71.5 |

c). Inserting contact into housing

Inserting crimped contact into housing

- (1) Do not apply any pulling force to crimped part, and insert contact parallel to housing
- (2) Insert contact into housing without stopping to innermost
- (3) Check secure locking per each insertion by pulling wire softly in order to check that contact does not come off housing. Besides, check whether there is the backlash in the direction of insertion axis.

Defect example of slation insertion

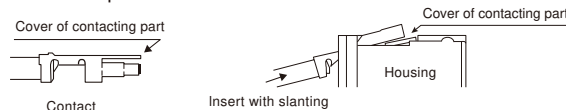

d). Mating and Unmating Connector

(1) Inserting connector

Hold receptacle housing securely and insert into header straight against to header post until click sounds.

(2) Unmating connector

Hold all wires securely and fix receptacle housing by fingers so as to pry, and then, withdraw it on the mating axis.

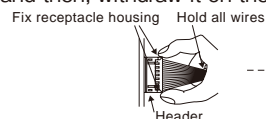

e). Routing of Wire

Routing wire so as not to apply external force to connector except force to such an extent that wire slightly buckles, considering an enough length to route and fixing of wire.

6. External Fuse Rating

Refer to the following fuse rating when selecting the external fuses that are to be used on input line. Surge current flows when line turns on. Use slow-blow or time-lag type fuse, not fast-blow fuse. Fuse rating is specified by in-rush current value at line turn-on. Do not select the fuse according to input cur-

rent (RMS.) values under the actual load condition.

HWS300 : 10A
HWS600 : 15A

7. Fan life expectancy

The Fan-life has limitation. Therefore, periodic maintenance by exchanging the life-expired fan is required for the power supply. The following figure shows the life of fan.

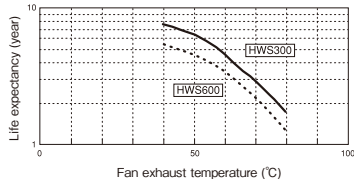

Measurement point of fan exhaust temperature

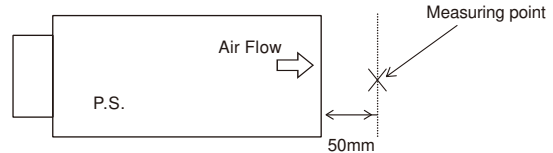

The difference between the intake temperature and the exhaust temperature of the power supply at Io=100% :

HWS300: 4°C
HWS600: 8°C

8. Before concluding that the unit is at fault...

Before concluding that the unit is at fault, make the following checks.

- (1) Check if the rated input voltage is connected.
- (2) Check if the wiring of input and output is correct.
- (3) Check if the I/O terminal connection is properly tightened by regulated torque.
- (4) Check if the wire thickness is enough.
- (5) Check if the output voltage control (V.adj) is properly adjusted. OVP might be triggered and output is shut down.
- (6) If use function of the Remote ON/OFF control, check if the Remote ON/OFF control connector is not opened. If in open condition, power supply will not output.
- (7) Check if the built-in FAN is not stopped. Is FAN stopped by

something irregulars or etc?

If FAN stops, the PF signal turn "High" level and OTP might be activated.

- (8) Power supply has ventilating holes on the front and back panels. Check if there is any irregulars or dust, etc.
- (9) Is the chassis of power supply hot abnormally? The output is shut down by OTP operation. Please re-input after the unit to cool down sufficiently.
- (10) Check if the output current and output wattage does not exceed specification.
- (11) Audible noise can be heard when input voltage waveform is not sinusoidal.
- (12) Audible noise can be heard during dynamic load operation.

9. Range of free warranty

This product is warranted for a period of 5 years from the date of shipment. As for the breakdown under a normal use during free warranty term, repair is at free of charge. However, the built-in FAN motor replacement is charged. Please contact to our sales office for FAN replacement.

- (3) Installation method : Standard installation. However, the maximum rating is within the output derating.

Conditions of usage at the free of charge warranty are as follows.

- (1) Average operating temperature (ambient temperature of the power supply unit) is under 40°C
- (2) Average load factor is 80% or less.

Following cases are not covered by warranty.

- (1) Improper usage like dropping products, applying shock and defects from operation exceeding specification of the units.
- (2) Defects resulting from natural disaster (fire, flood).
- (3) Unauthorized modifications or repair by the buyers defects not cause by DENSEI LAMBDA.

10. Option

Fan unit for replacement

We have prepared an optional fan unit for replacement.

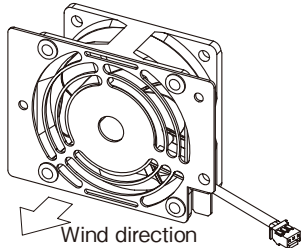
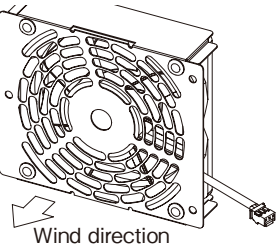
| Name of fan unit for replacement | Applicable models | Appearance | Pin assignments | Price | | | | | | | | |
|----------------------------------|--|---|---|---------|-------------|---|--------------|---|-----------|---|-----|------|
| 300-FAN-01 | HWS300 (of standard specifications) |  | Housing = PAP-03-V-S (J.S.T.) Contact = SPHD-001T-P0.5 or PSHD-002T-P0.5 (J.S.T.) <table border="1" data-bbox="938 1630 1209 1742"> <tr><th>Pin No.</th><th>Description</th></tr> <tr><td>1</td><td>Power supply</td></tr> <tr><td>2</td><td>Fan alarm</td></tr> <tr><td>3</td><td>GND</td></tr> </table> Length of fan harness = 55 ± 10mm | Pin No. | Description | 1 | Power supply | 2 | Fan alarm | 3 | GND | Open |
| Pin No. | Description | | | | | | | | | | | |
| 1 | Power supply | | | | | | | | | | | |
| 2 | Fan alarm | | | | | | | | | | | |
| 3 | GND | | | | | | | | | | | |
| 600-FAN-01 | HWS600 (of standard specifications) |  | Housing = PAP-03-V-S (J.S.T.) Contact = SPHD-001T-P0.5 or PSHD-002T-P0.5 (J.S.T.) <table border="1" data-bbox="938 1910 1209 2022"> <tr><th>Pin No.</th><th>Description</th></tr> <tr><td>1</td><td>Power supply</td></tr> <tr><td>2</td><td>Fan alarm</td></tr> <tr><td>3</td><td>GND</td></tr> </table> Length of fan harness = 70 ± 10mm | Pin No. | Description | 1 | Power supply | 2 | Fan alarm | 3 | GND | Open |
| Pin No. | Description | | | | | | | | | | | |
| 1 | Power supply | | | | | | | | | | | |
| 2 | Fan alarm | | | | | | | | | | | |
| 3 | GND | | | | | | | | | | | |

Ask us for replacement of the fan. This will be a charged service. If you are replacing the fan by yourself, note the following.

- *1. Be careful in handling the fan unit so as not to cause an impact by dropping it or hitting it, etc.
- *2. Shut down the input before starting the replacement operation.
- *3. Check that there are no loose parts in connectors or harness tucking, etc.
- *4. Safety standards (UL, CE, etc.) are not applicable.

HWS 1000 Series Instruction Manual

BEFORE USING THE POWER SUPPLY UNIT

Be sure to read the following precautions thoroughly before using this power supply unit.

Pay attention to all warnings and cautions before using the unit. Incorrect usage could lead to an electric shock, damage to the unit or a fire hazard.

WARNING

- Do not make unauthorized changes to power supply unit, otherwise you may have electric shock and void your warranty.
- Do not touch the internal components; they may have high voltage or high temperature. You may get electric shock or burned.
- When the unit is operating, keep your hands and face away from it; an accident may injure you.
- Do not use unit under unusual condition such as emission of smoke or abnormal smell and sound etc. It might cause fire and electric shock.
In such case, please contact us; do not repair by yourself, as it is dangerous for the user.
- Do not drop or insert anything into unit. It might cause failure and fire, when using the unit under such condition.
- Do not operate these units at the condition of condensation. It may cause fire and electric shock.
- This power supply has a possibility that hazardous voltage may occur in output terminal depending on failure mode.
- The outputs of these products must be earthed in the end use equipment to maintain SELV.
If the outputs are not earthed, they must be considered hazardous and must not be made user accessible.

CAUTION

- This power supply is primarily designed and manufactured to use and enclose in other equipment.
- This power supply unit has a built-in fan for air-cooling. Do not block air intake and exhaust. It might cause fire.
- Input voltage, output current, output power, ambient temperature and ambient humidity should be used within specifications, otherwise the unit will be damaged.
- The unit might be broken down by accident or unexpected situation. For application equipment, which requires very high reliability (nuclear related equipment, traffic control equipment, medical equipment, etc.), please provide fail safety function in the equipment.
- Do not make an improper wiring to input and output terminals. It may cause damage.
- Do not use in environment such as strong electromagnetic field, erosive gas etc, or any environment where conductive foreign substance may enter.
- Do not operate and store this unit at the condition of condensation. In such case, waterproof treatment is necessary.
- Do not operate this unit after it falls down.
- The output voltage of this power supply unit is considered to be a hazardous energy level (The voltage is 2V or more and the electric power is 240VA or more), prevention from direct contact with voltage output is highly necessary. While installing or servicing this power supply unit, avoid dropping tools by mistake or direct contact with voltage output. This might cause an electrical shock.
While repairing this power supply unit, the AC input power must be switch off and the I/O terminal voltage should be less than the safety level.

HWS

1. Terminal Explanation

Please pay extra attention to the wiring. Incorrect connection will damage the power supply.

- When connecting input and output wiring, input AC-Line should be off.
- Input wiring and output wiring shall be separated, otherwise noise susceptibility of power supply unit will be weak.

- The protective earth (PE) must be connected to the instrument chassis and the chassis of this power supply unit.
- Remote sensing lines shall be twisted or use the shielded wire.
- Remote ON/OFF control lines shall be twisted or use the shielded wire.

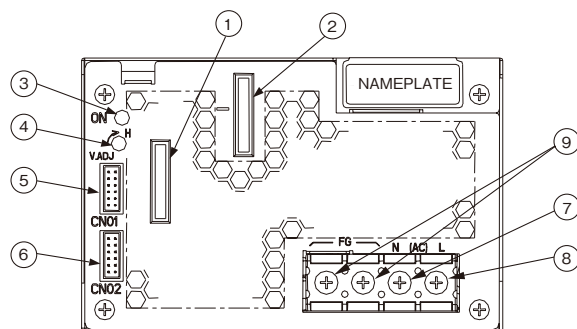
1 Front Panel Explanation

- ① +: + Output terminal
- ② -: - Output terminal
- ③ ON: Output (Power On) indication green LED (The indicator turns on when the power supply output is in normal operating condition.)
- ④ V.ADJ: Output voltage adjust trimmer (The output voltage rises when trimmer is turned clockwise.)
- ⑤ CN01: Remote sensing, ON/OFF control signal, Current balance signal,
- ⑥ CN02: Output voltage external control signal and Power fail signal output connector.
- ⑦ N: AC input terminal N : Neutral line
- ⑧ L: AC input terminal L : Live Line (Fuse in line)
- ⑨ FG: Function Ground terminal (Frame ground)

2 CN01, CN02 Connector pin configuration and function

CN01, CN02 pin configuration and function are the same.

They are connected to each other in this power supply unit.

When the pin of CN01 side is shorted the same function pins of CN02 side are shorted.

Please note that the function cannot be separately set with CN01 and CN02.

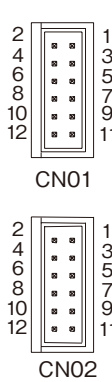
| | Pin No. | Configuration | Function |
|---|---------|---------------|---|
|  | 1 | +V | Connected to +Output terminal in this power supply unit. (+V terminal can not supply load current.) |
| | 2 | +S | Remote sensing terminal for +Output (For remote sensing function, which compensates for line drop between power supply terminals and load terminals. Connect to +V terminal when remote sensing function is unnecessary.) |
| | 3 | -V | Connected to -Output terminal in this power supply unit. (-V terminal can not supply load current.) |
| | 4 | -S | Remote sensing terminal for -Output (For remote sensing function, which compensates for line drop between power supply terminals and load terminals. Connect to -V terminal when remote sensing function is unnecessary.) |
| | 5 | PC | Current balance terminal (For output current balancing in parallel operation.) |
| | 6 | COM | Ground for PC and PV signal. |
| | 7 | PV | Output voltage external control terminal (For power supply output voltage control with an external voltage. Connect it with the terminal REF when PV function is unnecessary.) |
| | 8 | REF | Reference voltage terminal for Output voltage control (REF and PV are connected when shipping.) |
| | 9 | CNT | Remote ON/OFF control terminal (When the CNT is pulled to TTL low, the power supply turns on.) |
| | 10 | TOG | Ground for CNT and PF signal. |
| | 11 | PF | Power fail signal output terminal. (As the output voltage drops, FAN stops and AC input voltage down, open collector output, "Power Fail" signal will output "High".) |
| | 12 | TOG | Ground for CNT and PF signal. |

CN01, CN02 are connected in this power supply unit as follows.

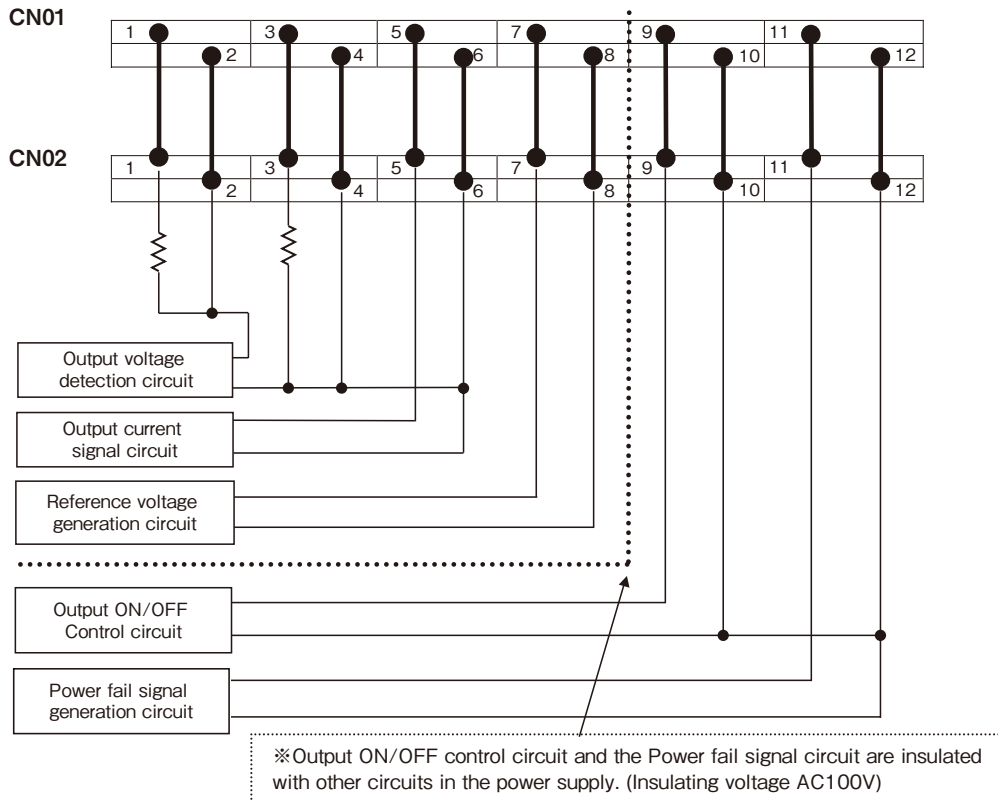

3 Basic Connection (Local sensing)

- ① Connect "+S" terminal to "+V" terminal and "-S" terminal to "-V" terminal with sensing wires.
 - ② Connect "CNT" terminal to "TOG" terminal with wire.
 - ③ Connect "PV" terminal to "REF" terminal with wire.
- ※ Please use attachment connector for each connection.
- ※ In the following cases, the output is shut down.
- When CNT and TOG is opened.
 - When PV and REF is opened.

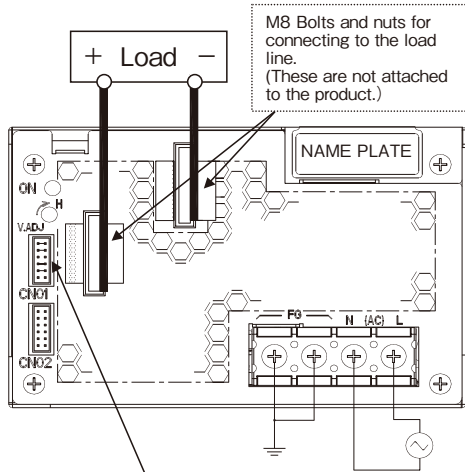

Connector : (JST) S12B-PHDSS

Attached connector when shipping

- Housing : (JST) PHDR-12VS
- Contact : (JST) SPHD-001T-P0.5

1-2, 3-4, 7-8, 9-10 are shorted.

4 Remote sensing required

- ① Connect "+S" terminal to "+" terminal of load with sensing wire.
 - ② Connect "-S" terminal to "-" terminal of load with sensing wires.
 - ③ Connect "CNT" terminal to "TOG" terminal with wire.
 - ④ Connect "PV" terminal to "REF" terminal with wire.
- ※ The accuracy of the output voltage will deteriorate when the sensing terminals are opened.
- ※ In the following cases, the output is shut down.
- When CNT and TOG is opened.
 - When PV and REF is opened.

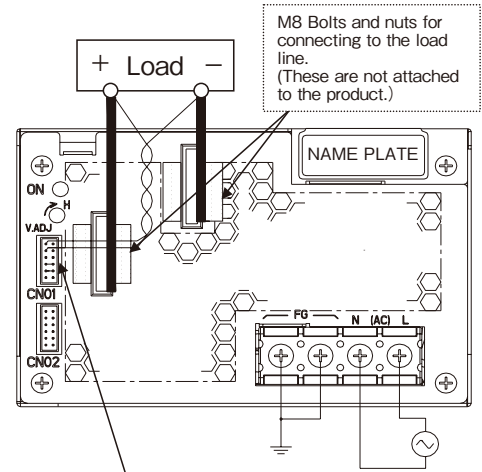

Connector : (JST) S12B-PHDSS

Remove standard attached connector, and use the harness made by the customer.

- Housing : (JST) PHDR-12VS
- Contact : (JST) SPHD-001T-P0.5

2-"+" of load, 4-"-" of load should be connected.

7-8, 9-10 : should be shorted

*Please use wire for contact and crimping tool specified by maker.

Attached connector when shipping

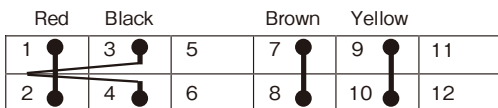

Twist wire

Connecting circuit with CN01 or CN02 connector

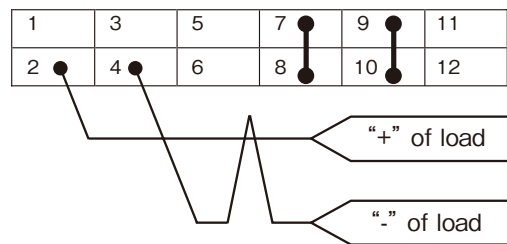

5 Remote ON/OFF control required

- ① Remove standard attached connector, and use the harness made by the customer and connect external signal to between CNT and TOG terminal.
- ② "TOG" terminal is ground for "CNT" terminal.
In case this function is not used, please short between CNT and TOG terminal.

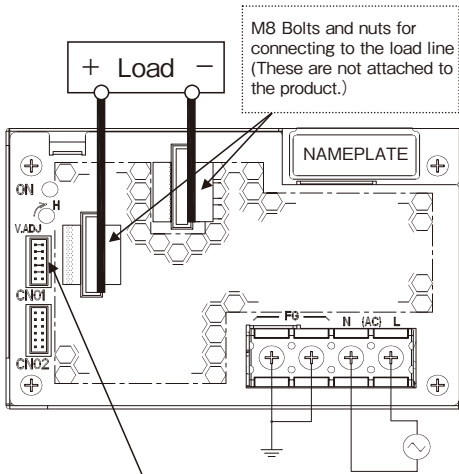

Connector : (JST) S12B-PHDSS

Remove standard attached connector, and use the harness made by the customer.

- Housing : (JST) PHDR-12VS
- Contact : (JST) SPHD-001T-P0.5

1-2, 3-4, 7-8 : should be shorted

9 : CNT
Should be connected to ON/OFF control signal.

10 : TOG
Should be connected to Signal Ground.

* Please use wire for contact and crimping tool specified by maker.

6 PF signal output required

- ① PF signal is an open collector output, therefore PF signal outputs is shown in circuit below.
- ② "TOG" terminal is ground for "PF" terminal.

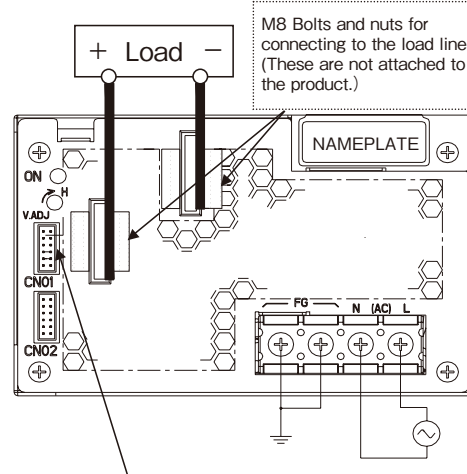

Connector : (JST) S12B-PHDSS

Remove standard attached connector, and use the harness made by the customer.

- Housing : (JST) PHDR-12VS
- Contact : (JST) SPHD-001T-P0.5

1-2, 3-4, 7-8, 9-10 : should be shorted.

11 : PF
Should be connected to PF signal output

12 : TOG
Should be connected to Signal Ground.

* Please use wire for contact and crimping tool specified by maker.

Connecting circuit with CN01 or CN02 connector

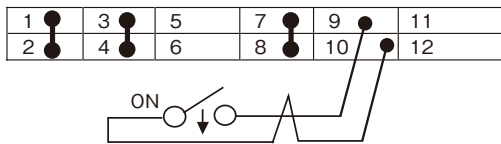

Connecting circuit with CN01 or CN02 connector

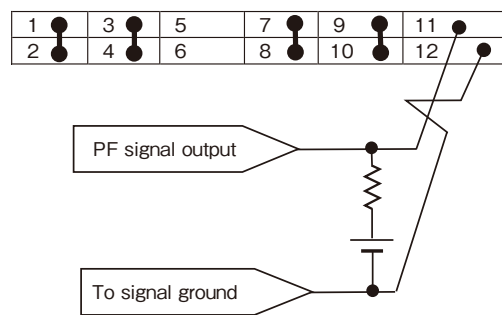

2. Functions and Precautions

1 Input Voltage Range

Input voltage range is single phase 85–265VAC (47–63Hz). Input voltage, which is out of specification, may cause unit damage. Rated input voltage range fix during safety standard application is from 100V to 240VAC (50/60Hz).

While applying input voltage from 85VAC to 90VAC, output load current derating is required.

2 Output Voltage Range

Output voltage is set to the rated value at shipping. V.ADJ trimmer on the front panel side is use to adjust the output voltage within the range specified. Output voltage trimming range is within -20%–+20% of the rated output voltage (48V, 60V model: -20% –+10%). Turn the trimmer clockwise to increase output voltage. Take note when the output voltage is increased excessively over voltage protection (OVP) function may trigger and output voltage will shut down.

Use the output power of the power supply below the rated output power value when you raise the output voltage.

3 Over Voltage Protection (OVP)

The OVP function (Inverter shut down method, manual reset type) is provided. OVP function operates within 125-145% of the rated DC output voltage value (3-7V model: 125-140%, 36V model: 125-138%, 48V, 60V model: 115-125%), and the output will be shut down when OVP function triggers. When OVP function operates, the input power is cut off for a few minutes, and then power is re-input or remote ON/OFF control signal shall be input for recovery of the output. OVP value is fixed and can not be adjusted.

4 Over Current Protection (OCP)

The OCP function (Constant current limiting, Time delay shutdown type) is provided. OCP function operates when the output current exceeds 105% of maximum DC output current specification and the over current or short circuit condition continues 5-second or more, the output will be shut down. When the OCP is triggered, the input power is cut off for a few minutes, and then power is re-input or remote ON/OFF control signal should be input for recovery of the output. The OCP setting is fixed and not to be adjusted externally.

5 Over Temperature Protection (OTP)

Over temperature protection function (manual reset type) is provided. When ambient or internal temperature rises abnormally, OTP will shut down the output. When OTP is triggered, input power is cut off and allow sufficient cooling to reset the OTP function. Then power is re-input or remote ON/OFF control signal should be input for recovery of the output.

6 Low Output Detection Circuit (PF)

Low output voltage detection circuit is provided. Power Fail signal (PF signal) will output when output voltage decrease by either the drop or brown out of the input voltage or OCP, OVP and OTP function operation. PF signal will turn "High" level to indicate the abnormal status of the power supply when the output voltage decrease to 80% of the output voltage setting value. However, there is a possibility that PF signal may not output during parallel operation. The PF signal circuit is insulated from the power supply input and output circuit and it is an open collector. TOG terminal is ground for PF terminal.

When the Built-in Fan Motor of this power supply unit stops, PF signal will turn to "H" and the output power will shut down. The Built-in Fan Motor is a component with lifetime. We recommend a periodic replacement. Please contact our sales office. Replacement is at customer's expenses.

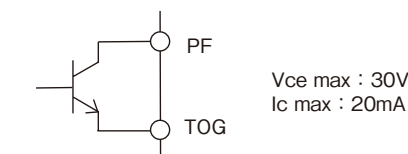

7 Remote Sensing (+S, -S terminal)

Remote sensing function is provided to compensate for voltage drop across the wiring from the power supply output terminals to the load input terminals. Connect "+S" terminal to "+" terminal of the load and "-S" terminal to "-" terminal of the load with sensing wires. The total line voltage drop (+ side line and - side line) shall be less than 0.3V. In case that sensing line is too long, it is necessary to put an electrolytic capacitor across the load terminals. Please take note that the electrolytic capacitor has generation of heat etc. done by the ripple current depending on connected load. Therefore, the electrolytic capacitor must have a ripple current allowance higher than the output ripple current. If CN01 (or CN02) is in use, terminal +S, -S for CN02 (or CN01) must be in open condition.

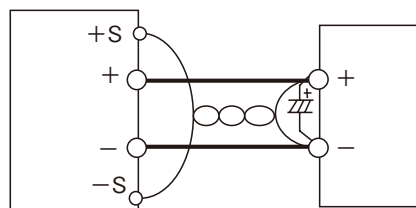

When the function of remote sensing is not in used, connect +S terminal to +V terminal, and -S terminal to -V terminal by the attachment connector.

If remote sensing terminals are opened, the stability and the accuracy of the output deteriorate. Therefore, terminal +S, -S must be connected.

8 Remote ON/OFF Control

Remote ON/OFF control is provided. Output can be remotely switch ON and OFF by using CNT terminal and TOG terminal even though input is connected. The output is turned to ON when TOG and CNT terminals are shorted and output is turned to OFF when these terminals are opened. When the function is not used, connect TOG and CNT terminals with short piece. The standards for this function are as follows. "TOG" terminal is ground for "CNT" terminal.

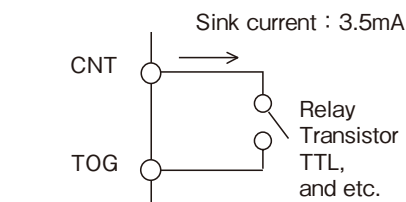

The Mode of control

| CNT Level for TOG Terminal | Output | Built-in Fan Motor |
|----------------------------|--------|--------------------|
| Short or L (0–0.8V) | ON | Rotate |
| Open or H (2.4–12V) | OFF | Stop |

- 1) TTL compatible. The maximum input voltage to CNT terminal is 12V, and the maximum allowable reverse voltage is -1V. The sink current of CNT terminal is 3.5mA.
- 2) Output ON/OFF control can be enable by a switch, relay or a transistor ON/OFF. When CNT terminal—TOG terminal is shorted power supply is turn ON, and when CNT terminal—TOG terminal is opened power supply is turn OFF.
- 3) Remote ON/OFF control circuit is isolated from the input and output circuit of power supply.
It is possible to use it regardless of the positive and negative of the power supply output.

Please be aware that if CNT terminal and TOG terminal is short and input voltage is gradually increase, this will trigger the low output voltage detector protection circuit and will result to output voltage shut down.

When the low output voltage detector protection circuit is triggered, the input power is cut off for a few minutes, and then power is re-input or remote ON/OFF control signal should be input for recovery of the output.

9 Output Ripple & Noise

Maximum ripple & noise value in specifications is measured according to measurement circuit specified by JEI-TA-RC9131A. When Load lines are longer, ripple & noise becomes larger. In this case, electrolytic capacitor, film capacitor, etc. might be necessary to use across the load terminal. The output ripple & noise cannot be measured accurately if the probe ground lead of oscilloscope is too long.

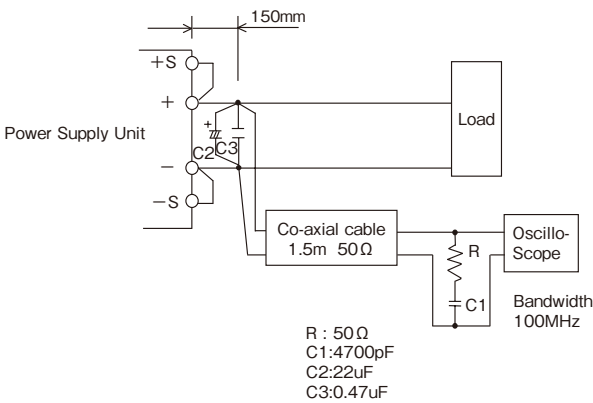

10 Series Operation

For series operation, either method (A) or (B) is possible. There might be a step in the rise waveform during series operation.

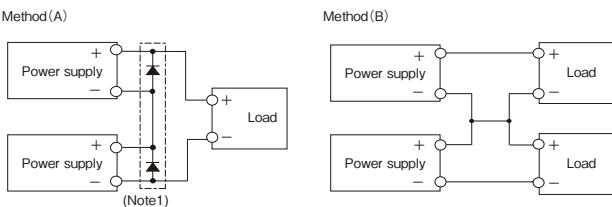

(Note1) Please connect a diode for by-pass when using method (A) of the series operation.
Please use the diode with rated forward current is equal or more than load current and that the rated maximum reverse voltage is higher than output voltage for each power supply.

11 Parallel Operation

Current balancing function is provided. Either of operations mode (A) or (B) is possible.

- (A) To Increase the Output Current
Current balancing function activates by connecting PC-to-PC terminal and COM-to-COM terminal, and output current of each power supply is equivalently

supplied to load. Wires to PC terminals shall be as short as possible, same length and twisted.

There is a possibility that output could be unstable caused by external noise. For this case, disconnect COM terminal and connect -S terminal from parallel power supply to a single point on the load. Please refer connection Method (A)-2.

- 1) Adjust the output voltage of each power supply to be same value within 1% or 100mV, whichever is smaller.
- 2) Use same length and type of wires for all load lines.
- 3) Maximum value of output current in parallel is up to 80% of all paralleled models. The purpose of the current balancing function is the static power-up. Therefore the output voltage might decrease according to the condition of dynamic load. There might be a step in the rise waveform during parallel operation.
- 4) Up to 5 units can be connected in parallel.

(B) To Use as a Backup Power Supply

- 1) Set power supply output voltage higher by the forward voltage drop of diode.
- 2) Adjust the output voltage of each power supply to be same value.
- 3) Use within the specifications for output voltage and output power.

Method (A)-1

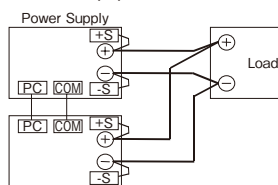

Method (A)-2

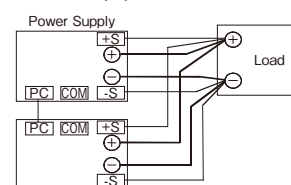

Method (B)

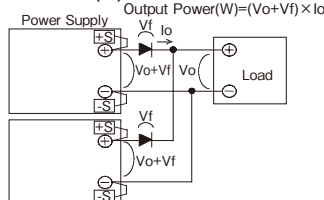

12 Isolation Test

Isolation resistance between output and FG (chassis) shall be more than 100MΩ (at 500VDC and between output and CNT·PF shall be more than 10MΩ (at 100VDC. For safety operation, voltage setting of DC isolation tester must be done before the test. Ensure that it is fully discharged after the test.

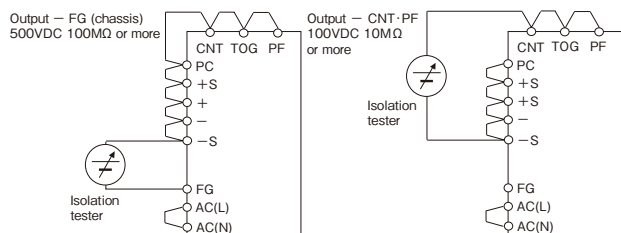

13 Withstand Voltage

This series is designed to withstand 3.0kVAC between input and output, 2.0kVAC between input and FG (chassis), 500VAC (60V model : 651VAC) between output and FG (chassis), and 100VAC between output and CNT·PF terminal each for 1 minute. When testing withstand voltage, set current limit of withstand voltage test equipment at 20mA.

(Output-FG (chassis) : 300mA (60V model : 390mA), Out-

put- CNT·PF : 100mA).
 The applied voltage must be gradually increased from zero to testing value and then gradually decreased for shut down. When timer is used, the power supply may be damaged by high impulse voltage at timer switch on and off. Connect input and output as follows. If output is left open during test, output voltage might appear momentarily. This product have monolithic ceramic capacitor in secondary circuit to frame ground.
 Some of the withstand voltage tester may generate high voltage at the matching with monolithic ceramic capacitor and may cause the unit damage.

So, please check the waveform of test voltage.

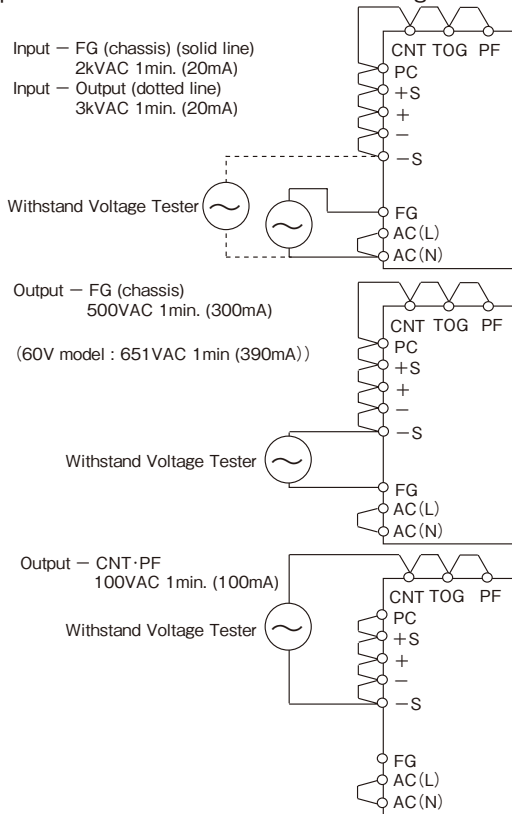

14 Output Voltage External Control (PV)

(A) Control by External Voltage

Output voltage external control function is provided. Output voltage can be varied by applying an external voltage (1-6V) to "PV" terminal and "COM" terminal. Note if an external voltage is not applied, there will be no output. Please consider the following characteristics below when operating the unit.

Connection Method

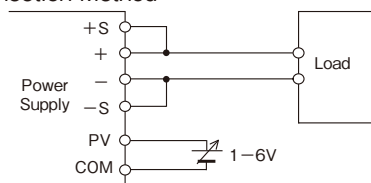

Output Voltage Linearity

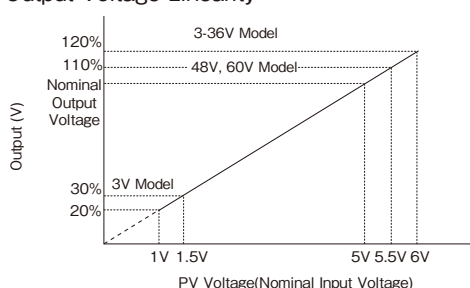

Note: Only as for the model of 3V output, the output voltage is used from 30% to 120% at the PV voltage is from 1.5V to 6.0V

Note: Only as for the model of 5-36V output, the output voltage is used from 20% to 120% at the PV voltage is from 1V to 6.0V

Note: Only as for the model of 48V, 60V output, the output voltage is used from 20% to 110% at the PV voltage is from 1V to 5.5V.

Output Voltage Derating

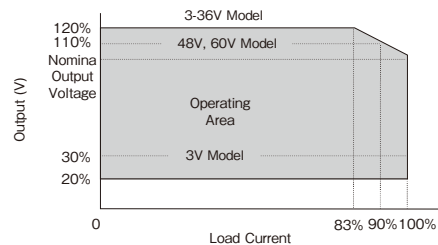

Note: Only as for the type of 48V, 60V output, the maximum output voltage is used up to 110% at 90% load current.

* Output voltage usage below 20% (3V model: 30%) is not guaranteed. There is a possibility that it cannot be used with certain product. Please conduct a thorough evaluation test before using it.

(B) Control by External Variable Resistor

"PV" terminal and "COM" terminal usage is the same as explained in section ["control by external voltage"]. But in this method voltage for control is supplied through REF terminal. Variable resistor is connected between REF terminal and COM terminal and the middle point of variable resistor is connected to PV terminal. Please use the output voltage within 20% - 120% of rated output voltage value (3V model : 30% - 120%, 48V, 60V model : 20% - 110%). Wires for control lines must be as short as possible and use twisted wire or shielded wire. In addition, maximum variable voltage when control by external variable resistor is rated output voltage (100%). When output voltage must be externally control to 120% of rated output voltage (110% for 48V, 60V model), please follow the following procedure.

- (1) PV terminal and REF terminal is short by using standard connector supplied.
- (2) Set the power supply output voltage to maximum value of the output voltage variable range mentioned in specification standard by adjusting V.ADJ volume at the front panel.
- (3) Remove standard connector after input is cut off.
- (4) Connect external variable resistor (50kΩ) between REF terminal and COM terminal. Then connect middle point of external variable resistor to PV terminal. (sensing current is 1.4mA)

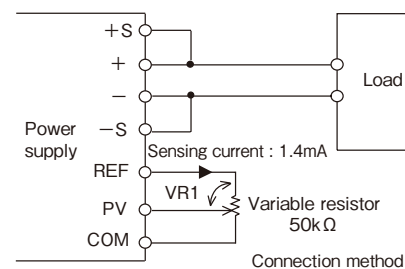

When output voltage is over rated value, please make sure that maximum output power is below rated value. Moreover, when output voltage is below rated value, please make sure that maximum output current is below rated value.

Please consider the following characteristic during usage.

Rated output voltage:

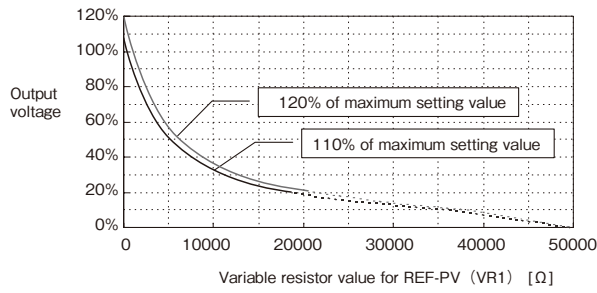

*Output voltage usage below 20% (3V model : 30%) is not a guaranteed. There is a possibility that it cannot be use with certain product. Please conduct a thorough evaluation test before using it.

(C) Control by External Variable Resistor (Parallel Connection)

“Control by External Variable Resistor” is connected in parallel. Voltage for control in this method is supplied through REF terminal. Variable resistor and an electrolytic capacitor or a ceramic capacitor is connected between REF terminal and COM terminal and the middle point of variable resistor is connected to PV terminal. Please use the output voltage within 20%-120% of rated output voltage value (48V output type : 20%-110%). Wires for control lines must be twisted wire or shielded wire. Please use the variable resistor more than 20kΩ. Please use the electrolytic capacitor or ceramic capacitor with rating more than 16V and capacitance more than 10uF. In addition, maximum variable voltage when controlled by external variable resistor is rated output voltage (100%). When output voltage must be externally controlled to 120% of rated output voltage (110% for 48V output type), please follow the following procedure.

- (1) PV terminal and REF terminal is short by using standard connector supplied.
- (2) Rise each power supply output voltage to maximum value by adjusting V.ADJ volume at the front panel.
- (3) Remove standard connector after input is cut off.
- (4) The volume of an external variable resistor is adjusted to the position in which resistance becomes maximum between REF-PV and the power supply output voltage becomes 0V.
- (5) Connect external variable resistor (20KΩ) between REF terminal and COM terminal. Then connect middle point of external variable resistor to PV terminal. (Sensing current is 6mA.)

Please use the connection method by a local sense or one point sense.

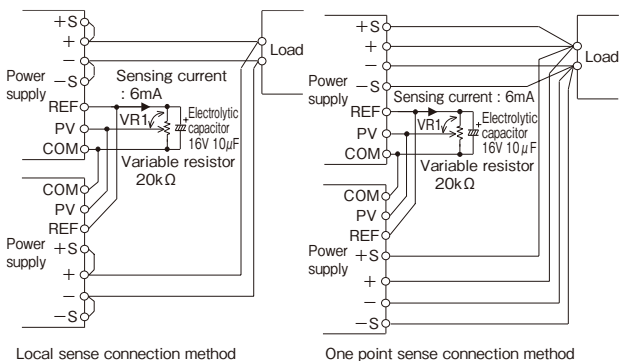

When output voltage is over rated value, please make sure that maximum output power is below rated value. More-

over, when output voltage is below rated value, please make sure that maximum output current is below rated value.

Please consider the following characteristic during usage.

Rated output : voltage

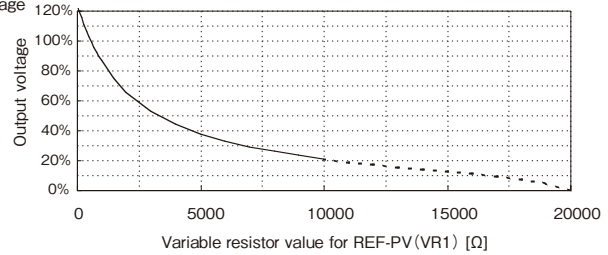

*Output voltage usage below 20% is not guaranteed. There is a possibility that it cannot be used with certain product. Please conduct a thorough evaluation test before using it.

15 Output Peak Current

For model with output peak current, please meet the following condition.

Reduce peak current value according to output derating as section 4-1.

The output is shut down by protection circuit when rated current and continuous peak output time (τ) exceeds rated value during usage.

When protection circuit is activated, input is temporarily cut off for a few minutes and then power is re-input or remote ON/OFF control signal should be input for recovery of the output.

Input voltage range : AC180V - 265V
 Continuous Peak output time (τ) : Within 10 seconds
 Peak output current (Ip) : Within the rated peak output current

Duty: up to 35%

$$\text{Duty} = \frac{\tau}{T} \times 100 (\%)$$

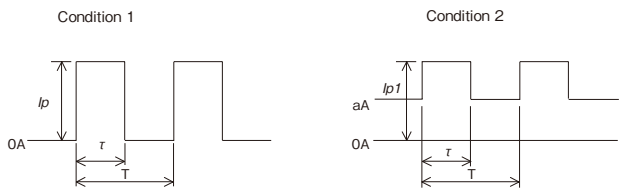

$$\sqrt{Ip^2 \times \frac{\tau}{T}} \leq I_{rms} \text{ max} \quad \sqrt{Ip1^2 \times \frac{\tau}{T} + a^2 \times (1 - \frac{\tau}{T})} \leq I_{rms} \text{ max}$$

Ip1: Peak output current (A)
 Irms: Effective current (A)
 τ: Peak current pulse width (sec)
 T: Cycle (sec)

| Model | Irms max |
|------------|----------|
| HWS1000-7 | 94.7A |
| HWS1000-12 | 59.2A |
| HWS1000-15 | 47.3A |
| HWS1000-24 | 29.6A |
| HWS1000-36 | 19.7A |
| HWS1000-48 | 14.8A |
| HWS1000-60 | 11.8A |

3. Mounting Directions

1 Output Derating

Mounting directions are as follows.
 Standard mounting method is (A). Methods (B), (C) and (D) are also possible.
 Mounting methods besides (A),(B),(C) and (D) (example : (E) and (F)) are inhibited.

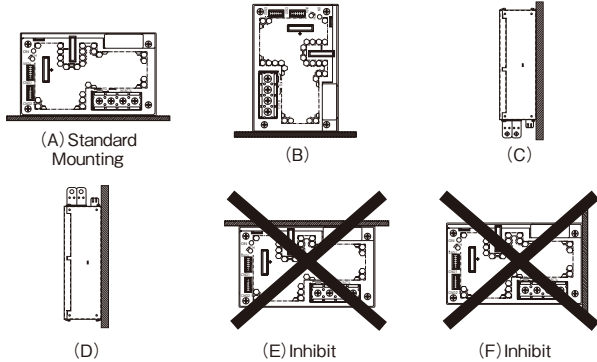

HWS1000 Output Derating

| Ta (°C) | LOAD (%) | | | |
|------------|----------|-----|-----|-----|
| | A | B | C | D |
| -10 to +35 | 100 | 100 | 100 | 100 |
| 50 (40) | 100 | 100 | 100 | 100 |
| 71 | 50 | 50 | 50 | 50 |

() : Only 5V model

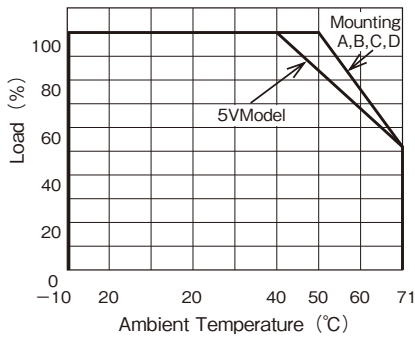

2 Mounting Method Caution

- (1) This Power supply unit is a forced air-cooling system with a built-in fan.
- (2) This power supply has ventilating holes on the front and back panels.
 Keep these areas freely more than 100mm from front side and more than 50mm from rear side.
- (3) Please note that ventilation will be worsened in a dusty environment.
- (4) Built-in fan is limited life part, which require periodic replacement. (Replacement will be charged).
- (5) The ambient temperature of this power supply is less than 50mm from the center of a front side.
- (6) The maximum allowable penetration of mounting screw is 6mm.
- (7) Recommended torque for mounting screw (M4) is 1.27N·m.

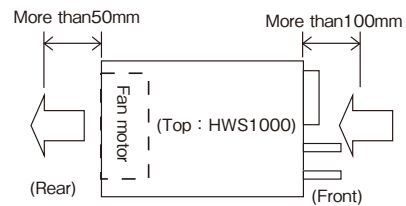

HWS

4. Wiring Method

- (1) The output load line and input line shall be separated and twisted to improve noise sensitivity.
- (2) The sensing lines shall be twisted or shield wire and separated from the output lines.
- (3) Use all lines as thick and short as possible to make lower impedance. Wires are to be twisted or use shield wire to improve noise sensitivity.
- (1) Attaching a capacitor to the load terminals can eliminate noise.
- (2) FG terminal of this power supply is functional earthing. For safety purposes, connect protective earthing terminal to the mounting set ground terminal.
- (3) Recommended torque for the terminal piece:

| | |
|----------------------------------|----------|
| Input terminal (M4 screw): | 1.27 N·m |
| Output terminal (M8 Bolt & Nut): | 10.8N·m |

(4) Recommended wiring

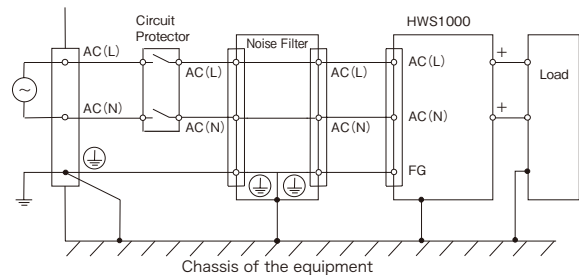

Recommended circuit protector: AC250V20A
 Recommended noise filter: RSEN-2020 (TDK-Lambda)

5. External Fuse Rating

Refer to the following fuse rating when selecting the external fuses for input line. Surge current flows when line turns on. Use slow-blow fuse or time-lug fuse. Do not use fast-blow fuse. Fuse rating is specified by in-rush current value

at line turn-on. Do not select the fuse according to input current (rms.) values under the actual load condition.

- HWS1000:20A

6. Troubleshooting

Before concluding that the unit is at fault, make the following checks.

- (1) Check if the rated input voltage is apply.
- (2) Check if the wiring of input and output is correct.
- (3) Check if the I/O terminal connection is properly tightened by a regulated tightening torque.
- (4) Check if the wire material is not too thin.
- (5) Check if the output voltage control (V.ADJ) is properly adjusted. OVP might be triggered and output is cut off.
- (6) Check if the wiring of "+S" and "-S" terminal is correct. If in open condition, when input voltage is apply, OVP is triggered and output is cut off. Output display LED will turn on for a moment.
- (7) If use function of the remote ON/OFF control, check if the remote ON/OFF control connector is not opened.
If in open condition, output is cut off.
- (8) Check if the built-in fan is not stopped. Is fan stopped by something irregulars or dust, etc.

If fan stops, the PF signal is turn on.

Moreover, the output is intercepted with the protection circuit if fan stops.

Fans are the limited life parts.

This power supply has ventilating holes on the front and back panels. Check if there is any irregulars or dust, etc.

- (9) Is the main body of the power supply abnormally hot? Please turn on the input again after allowing the unit to cool down sufficiently. The output shut down by over temperature protection function.
- (10) Check if the output current and output power is not applied over specification.
- (11) Check if the input voltage wave is sinusoidal. If this power supply unit is connected to a UPS, input voltage wave might not be sinusoidal. An audible noise is emitted from the power supply unit.
- (12) Audible noise can be heard during Dynamic-Load operation.

7. Warranty

This product is warranted for a period of 5 years from the date of shipment. As for the breakdown under a normal use during free warranty term, repair is at free of charge. However, the Built-in Fan Motor replacement is for a fee. Please contact your nearest sales office for replacement.

The Fan-life has limitation. Therefore, periodic maintenance by replacing the life-expired fan is required.

The following figure shows the life of fan.

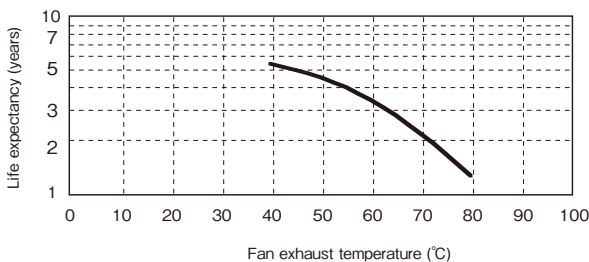

*Life expectancy

Fan exhaust temperature 45°C 45,000 hours

Fan exhaust temperature 80°C 11,000 hours

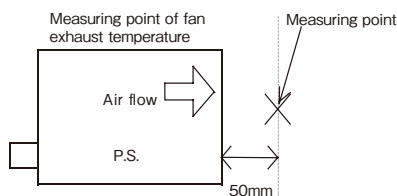

Conditions of usage at the free of charge warranty are as follows.

- (1) Average operating temperature (ambient temperature of the power supply unit) is 40°C
- (2) Average load factor is 80% or less
- (3) Installation method: Standard installation. However, the maximum rating is within the output derating.

Following cases are not covered by warranty.

- (1) Improper usage like dropping products, applying shock and defects from operation exceeding specification of the units.
- (2) Defects resulting from natural disaster (fire, flood).
- (3) Unauthorized modifications or repair by the buyers.
- (4) Defects not cause by DENSEI LAMBDA.

8. Option

1 Fan unit for replacement

We have prepared an optional fan unit for replacement.

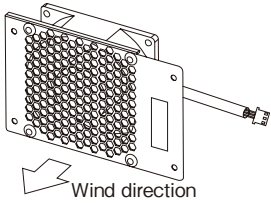
| Name of fan unit for replacement | Applicable models | Appearance | Pin assignments | Price | | | | | | | | |
|----------------------------------|--|---|--|---------|-------------|---|--------------|---|-----------|---|-----|------|
| 1000-FAN-01 | HWS1000 HWS1500 HWS1800T (of standard specifications) |  | Housing = XHP-3 (J.S.T.) Contact = SXH-001T-P0.6 (J.S.T.) <table border="1" style="margin-top: 5px;"> <thead> <tr> <th>Pin No.</th> <th>Description</th> </tr> </thead> <tbody> <tr> <td>1</td> <td>Power supply</td> </tr> <tr> <td>2</td> <td>Fan alarm</td> </tr> <tr> <td>3</td> <td>GND</td> </tr> </tbody> </table> Length of fan harness = 65 ± 10mm | Pin No. | Description | 1 | Power supply | 2 | Fan alarm | 3 | GND | Open |
| Pin No. | Description | | | | | | | | | | | |
| 1 | Power supply | | | | | | | | | | | |
| 2 | Fan alarm | | | | | | | | | | | |
| 3 | GND | | | | | | | | | | | |

Ask us for replacement of the fan. This will be a charged service. If you are replacing the fan by yourself, note the following.

- *1. Be careful in handling the fan unit so as not to cause an impact by dropping it or hitting it, etc.
- *2. Shut down the input before starting the replacement operation.
- *3. Check that there are no loose parts in connectors or harness tucking, etc.
- *4. Safety standards (UL, CE, etc.) are not applicable.

HWS 1500 Series Instruction Manual

BEFORE USING THE POWER SUPPLY UNIT

Be sure to read the following precautions thoroughly before using this power supply unit.

Pay attention to all warnings and cautions before using the unit. Incorrect usage could lead to an electric shock, damage to the unit or a fire hazard.

WARNING

- Do not make unauthorized changes to power supply unit, otherwise you may have electric shock and void your warranty.
- Do not touch the internal components; they may have high voltage or high temperature. You may get electric shock or burned.
- When the unit is operating, keep your hands and face away from it; an accident may injure you.
- Do not use unit under unusual condition such as emission of smoke or abnormal smell and sound etc. It might cause fire and electric shock.
In such case, please contact us; do not repair by yourself, as it is dangerous for the user.
- Do not drop or insert anything into unit. It might cause failure and fire, when using the unit under such condition.
- Do not operate these units at the condition of condensation. It may cause fire and electric shock.
- This power supply has a possibility that hazardous voltage may occur in output terminal depending on failure mode.
- The outputs of these products must be earthed in the end use equipment to maintain SELV.
If the outputs are not earthed, they must be considered hazardous and must not be made user accessible.

CAUTION

- This power supply is primarily designed and manufactured to use and enclose in other equipment.

- This power supply unit has a built-in fan for air-cooling. Do not block air intake and exhaust. It might cause fire.
- Input voltage, Output current, Output power, ambient temperature and ambient humidity should be used within specifications, otherwise the unit will be damaged.
- The unit might be broken down by accident or unexpected situation. For application equipment, which requires very high reliability (nuclear related equipment, traffic control equipment, medical equipment, etc.), please provide fail safety function in the equipment.
- Do not make an improper wiring to input and output terminals. It may cause damage.
- Do not use in environment such as strong electromagnetic field, erosive gas etc, or any environment where conductive foreign substance may enter.
- Do not operate and store this unit at the condition of condensation. In such case, waterproof treatment is necessary.
- Do not operate this unit after it falls down.
- The output voltage of this power supply unit is considered to be a hazardous energy level (The voltage is 2V or more and the electric power is 240VA or more), prevention from direct contact with voltage output is highly necessary. While installing or servicing this power supply unit, avoid dropping tools by mistake or direct contact with voltage output. This might cause an electric shock.
While repairing this power supply unit, the AC input power must be switch off and the I/O terminal voltage should be less than the safety level.

HWS

1. Terminal Explanation

Please pay extra attention to the wiring. Incorrect connection will damage the power supply.

- When connecting input and output wiring, input AC-Line should be off.
- Input wiring and output wiring shall be separated, otherwise noise susceptibility of power supply unit will be weak.

- The protective earth (PE) must be connected to the instrument chassis and the chassis of this power supply unit.
- Remote sensing lines shall be twisted or use the shielded wire.
- Remote ON/OFF control lines shall be twisted or use the shielded wire.

1 Front Panel Explanation

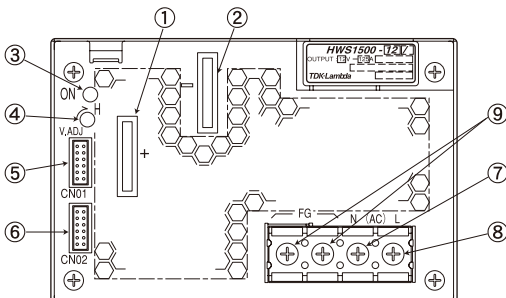

- ① + : + Output terminal
- ② - : - Output terminal
- ③ ON : Output (Power On) indication green LED
(The indicator turns on when the power supply output is in normal operating condition.)
- ④ V.ADJ : Output voltage adjust trimmer (The output voltage rises when trimmer is turned clockwise.)
- ⑤ CN01 : } Remote sensing, ON/OFF control signal, Current balance signal,
- ⑥ CN02 : } Output voltage external control signal and Power fail signal output connector.
- ⑦ N : AC input terminal N : Neutral line
- ⑧ L : AC input terminal L : Live Line (Fuse in line)
- ⑨ FG : Function Ground terminal (Frame ground)

2 CN01, CN02 Connector pin configuration and Function

CN01, CN02 pin configuration and function are the same.

They are connected to each other in this power supply unit.

When the pin of CN01 side is shorted the same function pins of CN02 side are shorted.

Please note that the function cannot be separately set with CN01 and CN02.

| | Pin No. | Configuration | Function |
|--|---------|---------------|---|
| | 1 | + V | Connected to + Output terminal in this Power supply unit. (+V terminal can not supply load current.) |
| | 2 | + S | Remote sensing terminal for + output (For remote sensing function, which compensates for line drop between power supply terminals and load terminals. Connect to +V terminal when remote sensing function is unnecessary) |
| | 3 | - V | Connected to - Output terminal in this Power supply unit. (-V terminal can not supply load current) |
| | 4 | - S | Remote sensing terminal for - output (For remote sensing function, which compensates for line drop between power supply terminals and load terminals. Connect to -V terminal when remote sensing function is unnecessary) |
| | 5 | PC | Current balance terminal (For output current balancing in parallel operation.) |
| | 6 | COM | Ground for PC and PV signal. |
| | 7 | PV | Output voltage external control terminal (For power supply output voltage control with an external voltage. Connect it with the terminal REF when PV function is unnecessary.) |
| | 8 | REF | Reference Voltage terminal for Output voltage control (REF and PV are connected when shipping.) |
| | 9 | CNT | Remote ON/OFF control terminal (When the CNT is pulled to TTL low, the power supply turns on.) |
| | 10 | TOG | Ground for CNT and PF signal. |
| | 11 | PF | Power fail signal output terminal. (As the output voltage drops, FAN stops and AC input voltage down, open collector output, "Power Fail" signal will output "High".) |
| | 12 | TOG | Ground for CNT and PF signal. |

CN01, CN02 are connected in this power supply unit as follows.

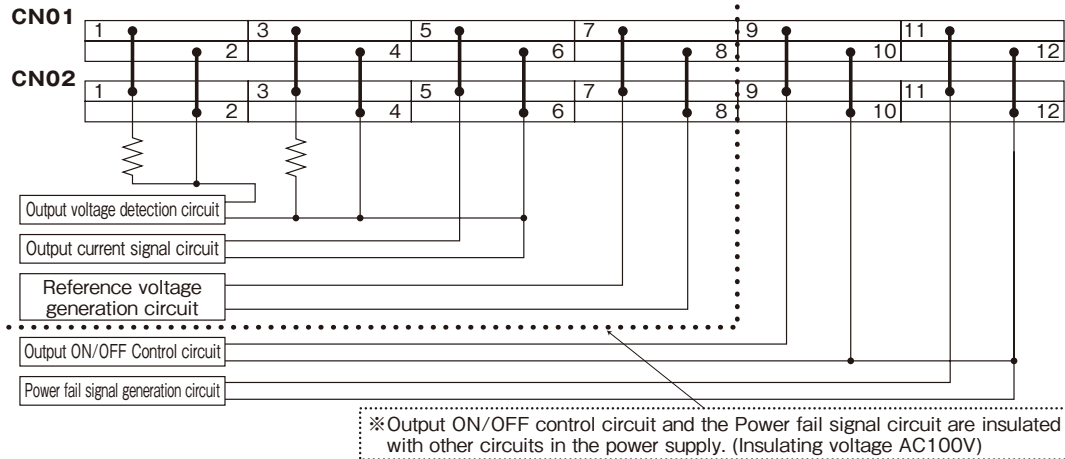

3 Basic Connection(Local sensing)

① Connect "+S" terminal to "+V" terminal and "-S" terminal to "-V" terminal with sensing wires.

② Connect "CNT" terminal to "TOG" terminal with wire.

③ Connect "PV" terminal to "REF" terminal with wire.

※ Please use attachment connector for each connection.

※ In the following cases, the output is shut down.

When CNT and TOG is opened.

When PV and REF is opened.

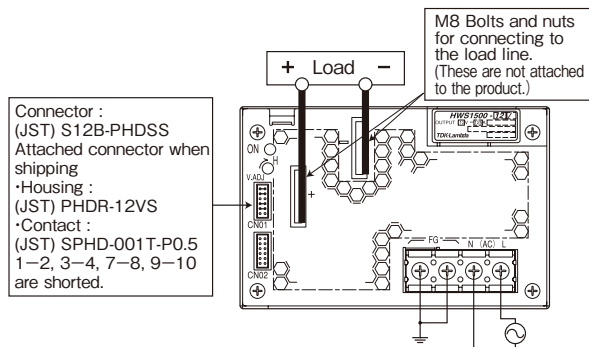

Attached connector when shipping

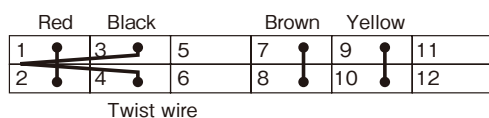

4 Remote sensing required

① Connect "+S" terminal to "+" terminal of load with sensing wire

② Connect "-S" terminal to "-" terminal of load with sensing wires.

③ Connect "CNT" terminal to "TOG" terminal with wire.

④ Connect "PV" terminal to "REF" terminal with wire.

※ The accuracy of the output voltage will deteriorate when the sensing terminals are opened.

※ In the following cases, the output is shut down.

When CNT and TOG is opened.

When PV and REF is opened.

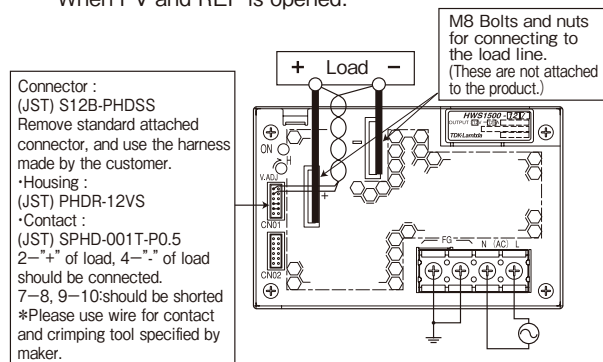

Connecting circuit with CN01 or CN02 connector

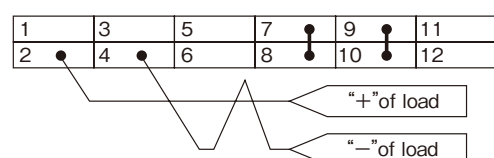

5 Remote ON/OFF control required

- ① Remove standard attached connector, and use the harness made by the customer and connect external signal to between CNT and TOG terminal.
 - ② "TOG" terminal is ground for "CNT" terminal.
- In case this function is not used, please short between CNT and TOG terminal.

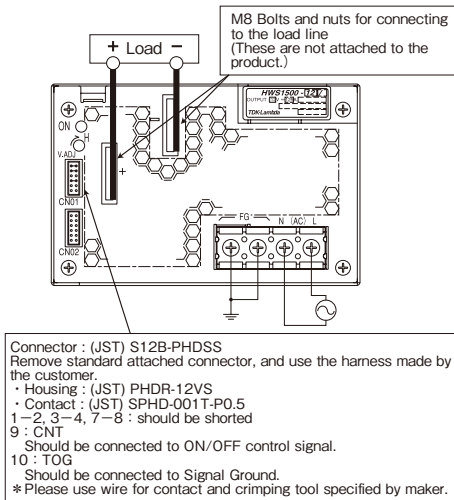

● Connecting circuit with CN01 or CN02 connector

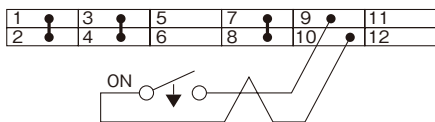

6 PF signal output required

- ① PF signal is an open collector output, therefore PF signal outputs is shown in circuit below.
- ② "TOG" terminal is ground for "PF" terminal.

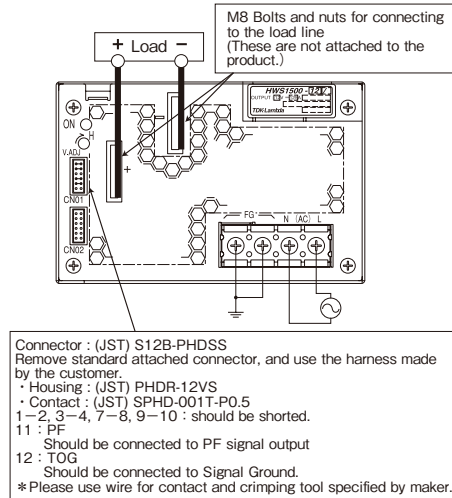

● Connecting circuit with CN01 or CN02 connector

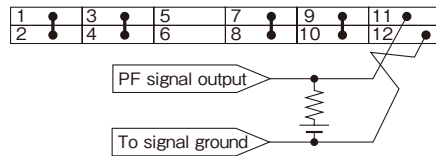

2. Functions and Precautions

1 Input Voltage Range

Input voltage range is single phase 85–265VAC (47–63Hz). Input voltage, which is out of specification, may cause unit damage. Rated input voltage range fix during safety standard application is from 100V to 240VAC (50/60Hz).

While applying input voltage from 85VAC to 90VAC, output load current derating is required.

2 Output Voltage Range

Output voltage is set to the rated value at shipping. V.ADJ trimmer on the front panel side is use to adjust the output voltage within the range specified. Output voltage trimming range is within -20% – +20% of the rated output voltage (48V Output Model: -20% – +10%). Turn the trimmer clockwise to increase output voltage. Take note when the output voltage is increased excessively over voltage protection (OVP) function may trigger and output voltage will shut down.

Use the output power of the power supply below the rated output power value when you raise the output voltage.

3 Over Voltage Protection (OVP)

The OVP function (Inverter shut down method, manual reset type) is provided. OVP function operates within 125-145% of the rated DC output voltage value (36V type: 125-138% , 48V type: 115-135%), and the output will be shut down when OVP function triggers. When OVP function operates, the input power is cut off for a few minutes, and then power is re-input or remote ON/OFF control signal shall be input for recovery of the output. OVP value is fixed and can not be adjusted.

4 Over Current Protection (OCP)

The OCP function (Constant current limiting, Time delay shutdown type) is provided. OCP function operates when the output current exceeds 105% of maximum DC output current specification and the over current or short circuit

condition continues 5-second or more, the output will be shut down. When the OCP is triggered, the input power is cut off for a few minutes, and then power is re-input or remote ON/OFF control signal should be input for recovery of the output. The OCP setting is fixed and not to be adjusted externally.

5 Over Temperature Protection (OTP)

Over temperature protection function (manual reset type) is provided. When ambient or internal temperature rises abnormally, OTP will shut down the output. When OTP is triggered, input power is cut off and allow sufficient cooling to reset the OTP function. Then power is re-input or remote ON/OFF control signal should be input for recovery of the output.

6 Low Output Detection Circuit (PF)

Low output voltage detection circuit is provided. Power Fail signal (PF signal) will output when output voltage decrease by either the drop or brown out of the input voltage or OCP, OVP and OTP function operation. PF signal will turn "High" level to indicate the abnormal status of the power supply when the output voltage decrease to 80 % of the output voltage setting value. The PF signal circuit is insulated from the power supply input and output circuit and it is an open collector. TOG terminal is ground for PF terminal.

When the Built-in Fan Motor of this power supply unit stops, PF signal will turn to "H" and the output power will shut down. The Built-in Fan Motor is a component with lifetime. We recommend a periodic replacement. Please contact our sales office. Replacement is at customer's expenses.

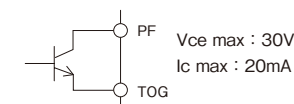

7 Remote Sensing (+S, -S terminal)

Remote sensing function is provided to compensate for voltage drop across the wiring from the power supply output terminals to the load input terminals. Connect "+S" terminal to "+" terminal of the load and "-S" terminal to "-" terminal of the load with sensing wires. The total line voltage drop (+ side line and - side line) shall be less than 0.3V. In case that sensing line is too long, it is necessary to put an electrolytic capacitor across the load terminals. Please take note that the electrolytic capacitor has generation of heat etc. done by the ripple current depending on connected load. Therefore, the electrolytic capacitor must have a ripple current allowance higher than the output ripple current. If CN01 (or CN02) is in use, terminal +S, -S for CN02 (or CN01) must be in open condition.

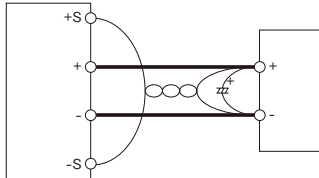

When the function of remote sensing is not in used, connect +S terminal to +V terminal, and -S terminal to -V terminal by the attachment connector.

If remote sensing terminals are opened, the stability and the accuracy of the output deteriorate. Therefore, terminal +S, -S must be connected.

8 Remote ON/OFF Control

Remote ON/OFF control is provided. Output can be remotely switch ON and OFF by using CNT terminal and TOG terminal even though input is connected. The output is turned to ON when TOG and CNT terminals are shorted and output is turned to OFF when these terminals are opened. When the function is not used, connect TOG and CNT terminals with short piece. The standards for this function are as follows. "TOG" terminal is ground for "CNT" terminal.

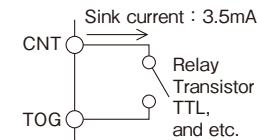

The Mode of control

| CNT Level for TOG Terminal | Output | Built-in Fan Motor |
|----------------------------|--------|--------------------|
| Short or L (0-0.8V) | ON | Rotate |
| Open or H (2.4-12V) | OFF | Stop |

- 1) TTL compatible. The maximum input voltage to CNT terminal is 12V, and the maximum allowable reverse voltage is -1V. The sink current of CNT terminal is 3.5mA.
- 2) Output ON/OFF control can be enable by a switch, relay or a transistor ON/OFF. When CNT terminal-TOG terminal is shorted power supply is turn ON, and when CNT terminal-TOG terminal is opened power supply is turn OFF.
- 3) Remote ON/OFF control circuit is isolated from the input and output circuit of power supply. It is possible to use it regardless of the positive and negative of the power supply output.

Please be aware that if CNT terminal and TOG terminal is short and input voltage is gradually increase, this will trigger the low output voltage detector protection circuit and will result to output voltage shut down.

When the low output voltage detector protection circuit is triggered, the input power is cut off for a few minutes, and then power is re-input or remote ON/OFF control signal should be input for recovery of the output.

9 Output Ripple & Noise

Maximum ripple & noise value in specifications is mea-

sured according to measurement circuit specified by JEITA-RC9131A. When Load lines are longer, ripple & noise becomes larger. In this case, electrolytic capacitor, film capacitor, etc. might be necessary to use across the load terminal. The output ripple & noise cannot be measured accurately if the probe ground lead of oscilloscope is too long.

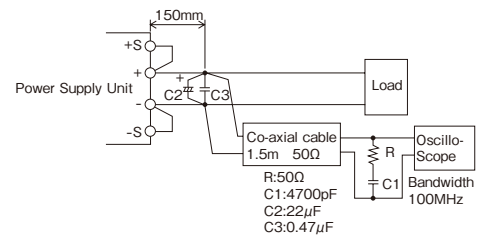

10 Series Operation

For series operation, either method (A) or (B) is possible. There might be a step in the rise waveform during series operation.

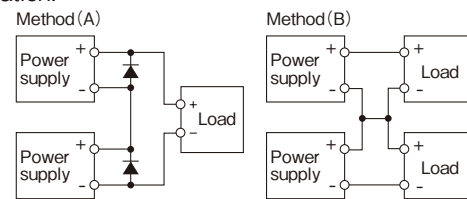

(Note1)

Please connect a diode for by-pass when using method (A) of the series operation.

Please use the diode with rated forward current is equal or more than load current and that the rated maximum reverse voltage is higher than output voltage for each power supply.

11 Parallel Operation

Current balancing function is provided. Either of operations mode (A) or (B) is possible.

(A) To Increase the Output Current

Current balancing function activates by connecting PC-to-PC terminal and COM-to-COM terminal, and output current of each power supply is equivalently supplied to load. Wires to PC terminals shall be as short as possible, same length and twisted.

There is a possibility that output could be unstable caused by external noise. For this case, disconnect COM terminal and connect -S terminal from parallel power supply to a single point on the load. Please refer connection Method (A)-2.

- 1) Adjust the output voltage of each power supply to be same value within 1% or 100mV, whichever is smaller.
- 2) Use same length and type of wires for all load lines.
- 3) Maximum value of output current in parallel is up to 80% of all paralleled models. The purpose of the current balancing function is the static power-up. Therefore the output voltage might decrease according to the condition of dynamic load. There might be a step in the rise waveform during parallel operation.

4) Up to 5 units can be connected in parallel.

(B) To Use as a Backup Power Supply

- 1) Set power supply output voltage higher by the forward voltage drop of diode.
- 2) Adjust the output voltage of each power supply to be same value.
- 3) Use within the specifications for output voltage and output power.

(C) In the case of parallel connections, it is possible to control the output voltage by adjusting the volume from only 1 unit. Choose 1 unit that would act as the master

and this unit's volume will determine the output voltage. The volume on each slave units must be turned clockwise to maximum position. Then adjust the master volume to set the output voltage.

Connection for this application is shown in figure (c).

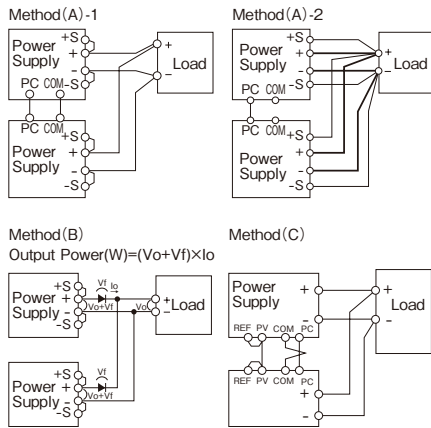

14 Output Voltage External Control (PV)

(A) Control by External Voltage

Output voltage external control function is provided. Output voltage can be varied by applying an external voltage (1–6V) to “PV” terminal and “COM” terminal. Note if an external voltage is not applied, there will be no output. Please consider the following characteristics below when operating the unit.

Connection Method

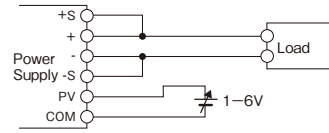

Output Voltage Linearity

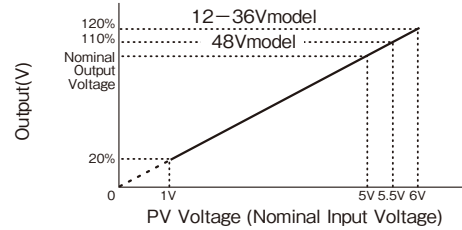

Note: Only as for the type of 48V output, the output voltage is used from 20% to 110% at the PV voltage is from 1V to 5.5V

Output Voltage Derating

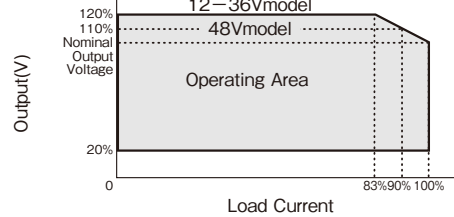

Note: Only as for the type of 48V output, the maximum output voltage is used up to 110% at 90% load current. * Output voltage usage below 20% is not a guaranteed.

There is a possibility that it cannot be use with certain product. Please conduct a thorough evaluation test before using it.

(B) Control by External Variable Resistor

“PV” terminal and “COM” terminal usage is the same as explained in section [control by external voltage]. But in this method voltage for control is supplied through REF terminal. Variable resistor is connected between REF terminal and COM terminal and the middle point of variable resistor is connected to PV terminal. Please use the output voltage within 20% - 120% of rated output voltage value (48V output type : 20% - 110%). Wires for control lines must be as short as possible and use twisted wire or shield wire. In addition, maximum variable voltage when control by external variable resistor is rated output voltage (100%). When output voltage must be externally control to 120% of rated output voltage (110% for 48V output type), please follow the following procedure.

- (1) PV terminal and REF terminal is short by using standard connector supplied.
- (2) Set the power supply output voltage to maximum value of the output voltage variable range mentioned in specification standard by adjusting V.ADJ volume at the front panel.
- (3) Remove standard connector after input is cut off.
- (4) Connect external variable resistor (50kΩ) between REF terminal and COM terminal. Then connect middle point of external variable resistor to PV terminal. (Sensing current is 1.4mA)

12 Isolation Test

Isolation resistance between output and FG (chassis) shall be more than 100MΩ at 500VDC and between output and CNT·PF shall be more than 10MΩ at 100VDC. For safety operation, voltage setting of DC isolation tester must be done before the test. Ensure that it is fully discharged after the test.

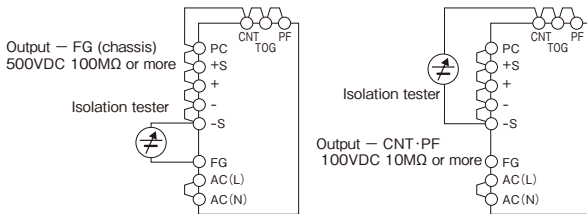

13 Withstand Voltage

This series is designed to withstand 3.0kVAC between input and output, 2.0kVAC between input and FG (chassis), 500VAC between output and FG (chassis), and 100VAC between output and CNT·PF terminal each for 1 minute. When testing withstand voltage, set current limit of withstand voltage test equipment at 20mA. (Output-FG (chassis) : 300mA, Output- CNT·PF : 100mA). The applied voltage must be gradually increased from zero to testing value and then gradually decreased for shut down. When timer is used, the power supply may be damaged by high impulse voltage at timer switch on and off. Connect input and output as follows. If output is left open during test, output voltage might appear momentarily. This product have monolithic ceramic capacitor in secondary circuit to frame ground.

Some of the withstand voltage tester may generate high voltage at the matching with monolithic ceramic capacitor and may cause the unit damage. So, please check the waveform of test voltage.

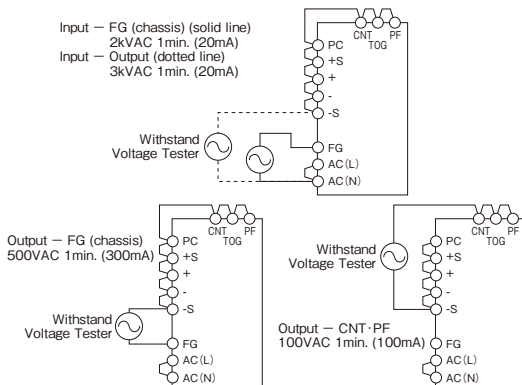

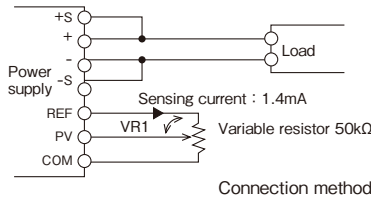

When output voltage is over rated value, please make sure that maximum output power is below rated value. Moreover, when output voltage is below rated value, please make sure that maximum output current is below rated value.

Please consider the following characteristic during usage.

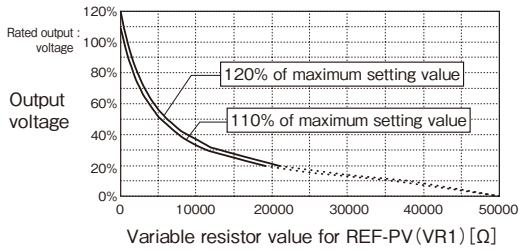

* Output voltage usage below 20% is not a guaranteed. There is a possibility that it cannot be use with certain product. Please conduct a thorough evaluation test before using it.

Reduce peak current value according to output derating as section 4-1.

The output is shut down by protection circuit when rated current and continuous peak output time (τ) exceeds rated value during usage.

When protection circuit is activated, input is temporarily cut off for a few minutes and then power is re-input or remote ON/OFF control signal should be input for recovery of the output.

Input voltage range : AC180V - 265V
 Continuous Peak output time. (τ) : Within 10 seconds
 Peak output current (I_p) : Within the rated peak output current
 Duty : up to 35%
 Duty = $\frac{\tau}{T} \times 100$ (%)

Condition 1

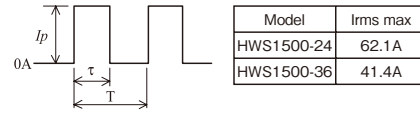

$$N I_p^2 \times \frac{\tau}{T} \leq I_{rms \max}$$

Condition 2

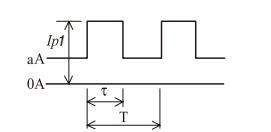

$$N (I_{p1}^2 \times \frac{\tau}{T} + a^2 \times (1 - \frac{\tau}{T})) \leq I_{rms \max}$$

I_{p1} : Peak output current (A)
 Irms : Effective current (A)
 τ : Peak current pulse width (sec)
 T : cycle (sec)

15 Output Peak Current

For model HWS1500-24 and HWS1500-36, please meet the following condition.

3. Mounting Directions

1 Output Derating

Mounting directions are as follows. Standard mounting method is (A). Methods (B), (C) and (D) are also possible.

Mounting methods besides (A), (B), (C) and (D) (example: (E) and (F)) are inhibit.

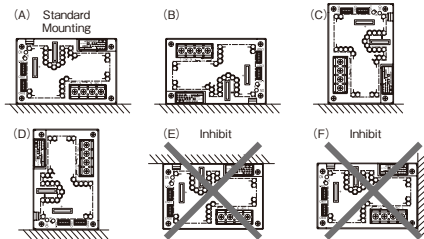
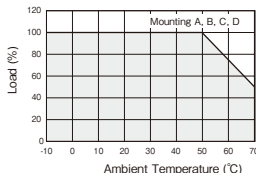

HWS1500 Output Derating

| Ta(°C) | LOAD(%) | | | |
|-----------|---------|-----|-----|-----|
| | A | B | C | D |
| -10 ~ +35 | 100 | 100 | 100 | 100 |
| 45 | 100 | 100 | 100 | 100 |
| 50 | 100 | 100 | 100 | 100 |
| 60 | 75 | 75 | 75 | 75 |
| 70 | 50 | 50 | 50 | 50 |

2 Mounting Method Caution

- (1) This Power supply unit is a forced air-cooling system with a built-in fan.
- (2) This power supply has ventilating holes on the front and back panels. Keep these areas freely more than 100mm from front side and more than 50mm from rear side.
- (3) Please note that ventilation will be worsened in a dusty environment.
- (4) Built-in fan is limited life part, which require periodic replacement. (Replacement will be charge).
- (5) The ambient temperature of this power supply is less than 50mm from the center of a front side.

- (6) The maximum allowable penetration of mounting screw is 6mm.
- (7) Recommended torque for mounting screw (M4) is 1.27N · m.

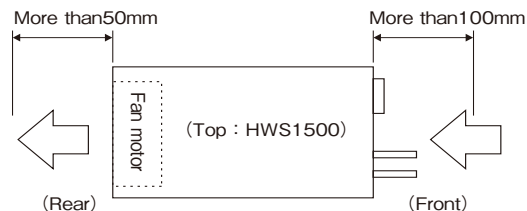

4. Wiring Method

- (1) The output load line and input line shall be separated and twisted to improve noise sensitivity.
- (2) The sensing lines shall be twisted or shield wire and separated from the output lines.
- (3) Use all lines as thick and short as possible to make lower impedance. Wires are to be twisted or use shield wire to improve noise sensitivity.
- (4) Attaching a capacitor to the load terminals can eliminate noise.
- (5) FG terminal of this power supply is functional earthing. For safety purposes, connect protective earthing terminal to the mounting set ground terminal.
- (6) Recommended torque for the terminal piece:

Input terminal (M4 screw) : 1.27 N·m
 Output terminal (M8 Bolt & Nut) : 10.8N · m

(7) Recommended wiring

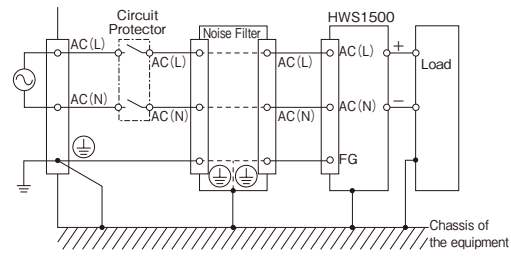

Recommended circuit protector : AC250V30A
 Recommended noise filter : MXB1220 (DENSEI-LAMBDA)

5. External Fuse Rating

Refer to the following fuse rating when selecting the external fuses for input line. Surge current flows when line turns on. Use slow-blow fuse or time-lag fuse. Do not use fast-blow fuse. Fuse rating is specified by in-rush current value at line turn-on. Do not

select the fuse according to input current (rms.) values under the actual load condition.

HWS1500 : 30A

6. Troubleshooting

Before concluding that the unit is at fault, make the following checks.

- (1) Check if the rated input voltage is apply.
- (2) Check if the wiring of input and output is correct.
- (3) Check if the I/O terminal connection is properly tighten by a regulated tightening torque.
- (4) Check if the wire material is not too thin.
- (5) Check if the output voltage control (V.ADJ) is properly adjusted. OVP might be trigged and output is cut off.
- (6) Check if the wiring of "+S" and "-S" terminal is correct. If in open condition, when input voltage is apply, OVP is trigged and output is cut off. Output display LED will turn on for a moment.
- (7) If use function of the remote ON/OFF control, check if the remote ON/OFF control connector is not opened. If in open condition, output is cut off.
- (8) Check if the built-in fan is not stopped. Is fan stopped by something irregulars or dust, etc. If fan stops, the PF signal is turn on. Moreover, the output is intercepted with the protection circuit

if fan stops.

Fans are the limited life parts.

This power supply has ventilating holes on the front and back panels. Check if there is any irregulars or dust, etc.

- (9) Is the main body of the power supply abnormally hot? Please turn on the input again after allowing the unit to cool down sufficiently. The output shut down by over temperature protection function.
- (10) Check if the output current and output power is not applied over specification.
- (11) Check if the input voltage wave is sinusoidal. If this power supply unit is connected to a UPS, input voltage wave might not be sinusoidal. An audible noise is emmitted from the power supply unit.
- (12) Audible noise can be heard during Dynamic-Load operation.

7. Warranty

This product is warranted for a period of 5 years from the date of shipment. As for the breakdown under a normal use during free warrantee term, repair is at free of charge. However, the Built-in Fan Motor replacement is for a fee.

Please contact your nearest sales office for replacement.

The Fan-life has limitation. Therefore, periodic maintenance by replacing the life-expired fan is required.

The following figure shows the life of fan.

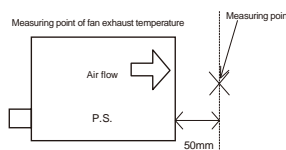
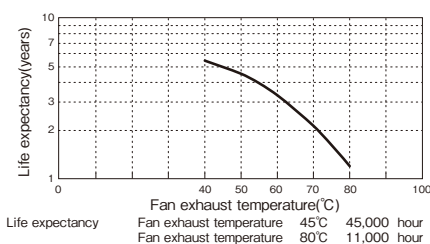

Conditions of usage at the free of charge warrantee are as follows.

- (1) Average operating temperature (ambient temperature of the power supply unit) is 40°C
- (2) Average load factor is 80% or less
- (3) Installation method: Standard installation. However, the maximum rating is within the output derating.

Following cases are not covered by warranty.

- (1) Improper usage like dropping products, applying shock and defects from operation exceeding specification of the units.
- (2) Defects resulting from natural disaster (fire, flood).
- (3) Unauthorized modifications or repair by the buyers.
- (4) Defects not cause by DENSEI LAMBDA.

8. Option

1 Fan unit for replacement

We have prepared an optional fan unit for replacement.

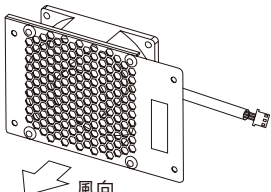
| Name of fan unit for replacement | Applicable models | Appearance | Pin assignments | Price | | | | | | | | |
|----------------------------------|--|---|--|---------|-------------|---|--------------|---|-----------|---|-----|------|
| 1500-FAN-01 | HWS1000 HWS1500 HWS1800T (of standard specifications) |  | Housing = XHP-3(J.S.T.) Contact = SXH-001T-P0.6(J.S.T.) <table border="1" style="margin-left: auto; margin-right: auto;"> <thead> <tr> <th>Pin No.</th> <th>Description</th> </tr> </thead> <tbody> <tr> <td style="text-align: center;">1</td> <td style="text-align: center;">Power supply</td> </tr> <tr> <td style="text-align: center;">2</td> <td style="text-align: center;">Fan alarm</td> </tr> <tr> <td style="text-align: center;">3</td> <td style="text-align: center;">GND</td> </tr> </tbody> </table> Length of fan harness = 65 ± 10mm | Pin No. | Description | 1 | Power supply | 2 | Fan alarm | 3 | GND | Open |
| Pin No. | Description | | | | | | | | | | | |
| 1 | Power supply | | | | | | | | | | | |
| 2 | Fan alarm | | | | | | | | | | | |
| 3 | GND | | | | | | | | | | | |

Ask us for replacement of the fan. This will be a charged service. If you are replacing the fan by yourself, note the following.

- *1. Be careful in handling the fan unit so as not to cause an impact by dropping it or hitting it, etc.
- *2. Shut down the input before starting the replacement operation.
- *3. Check that there are no loose parts in connectors or harness tucking, etc.
- *4. Safety standards (UL, CE, etc.) are not applicable.

HWS 1800T Series Instruction Manual

BEFORE USING THE POWER SUPPLY UNIT

Be sure to read the following precautions thoroughly before using this power supply unit.

Pay attention to all warnings and cautions before using the unit. Incorrect usage could lead to an electrical shock, damage to the unit or a fire hazard.

WARNING

- Do not make unauthorized changes to power supply unit, otherwise you may have electric shock and void your warranty.
- Do not touch the internal components; they may have high voltage or high temperature. You may get electrical shock or burned.
- When the unit is operating, keep your hands and face away from it; an accident may injure you.
- Do not use unit under unusual condition such as emission of smoke or abnormal smell and sound etc. It might cause fire and electric shock.
In such case, please contact us; do not repair by yourself, as it is dangerous for the user.
- Do not drop or insert anything into unit. It might cause failure and fire, when using the unit under such condition.
- Do not operate these units at the condition of condensation. It may cause fire and electric shock.
- Power supplies with an output voltage of 48Vdc or less must be earthed in the end use equipment to maintain SELV. If the outputs are not earthed, they must be considered hazardous and must not be made user accessible.
- Power supplies with an output voltage of 60Vdc are considered to be non-SELV. As a result of this, the output must be guarded or a deflector fitted during installation to avoid a SERVICE ENGINEER making inadvertent contact with the output terminals, or dropping a tool onto them. The output of this product must not be connected to a SELV circuit.

CAUTION

- This power supply is primarily designed and manufactured to use and enclose in other equipment.
- This power supply unit has a built-in fan for air-cooling. Do not block air intake and exhaust. It might cause fire.
- Input voltage, Output current, Output power, ambient temperature and ambient humidity should be used within specifications, otherwise the unit will be damaged.
- The unit might be broken down by accident or unexpected situation. For application equipment, which requires very high reliability (nuclear related equipment, traffic control equipment, medical equipment, etc.), please provide fail safety function in the equipment.
- Do not make an improper wiring to input and output terminals. It may cause damage.
- Do not use in environment such as strong electromagnetic field, erosive gas etc, or any environment where conductive foreign substance may enter.
- Do not operate and store this unit at the condition of condensation. In such case, waterproof treatment is necessary.
- Do not operate this unit after it falls down.
- The output voltage of this power supply unit is considered to be a hazardous energy level (The voltage is 2V or more and the electric power is 240VA or more), prevention from direct contact with voltage output is highly necessary. While installing or servicing this power supply unit, avoid dropping tools by mistake or direct contact with voltage output. This might cause an electrical shock.
While repairing this power supply unit, the AC input power must be switch off and the I/O terminal voltage should be less than the safety level.

HWS

1. Terminal Explanation

Please pay extra attention to the wiring. Incorrect connection will damage the power supply.

- When connecting input and output wiring, input AC-Line should be off.
- Input wiring and output wiring shall be separated, otherwise noise susceptibility of power supply unit will be weak.

- The protective earth (PE) must be connected to the instrument chassis and the chassis of this power supply unit.
- Remote sensing lines shall be twisted or use the shielded wire.
- Remote ON/OFF control lines shall be twisted or use the shielded wire.

1 Front Panel Explanation

HWS1800T Front Panel

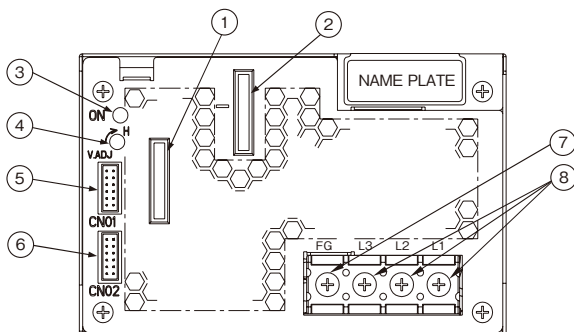

- ① + : + Output terminal
- ② - : - Output terminal
- ③ ON : Output (Power On) indication green LED
(The indicator turns on when the power supply output is in normal operating condition.)
- ④ V.ADJ : Output voltage adjust trimmer
(The output voltage rises when trimmer is turned clockwise.)
- ⑤ CN01 : } Remote sensing, ON/OFF control signal, Current balance signal,
- ⑥ CN02 : } Output voltage external control signal and Power fail signal output connector.
- ⑦ FG : Function Ground terminal (Frame ground)
- ⑧ L1,L2,L3 : Three phase AC input terminal (Fuse in each line)

2 CN01, CN02 Connector pin configuration and function

CN01, CN02 pin configuration and function are the same.

They are connected to each other in this power supply unit.

When the pin of CN01 side is shorted the same function pins of CN02 side are shorted.

Please note that the function cannot be separately set with CN01 and CN02.

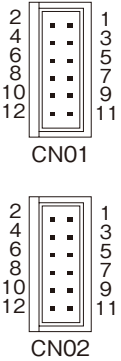
| | Pin No. | Configuration | Function |
|---|---------|---------------|---|
|  | 1 | +V | Connected to +Output terminal in this Power supply unit. (+V terminal can not supply load current.) |
| | 2 | +S | Remote sensing terminal for + output (For remote sensing function, which compensates for line drop between power supply terminals and load terminals. Connect to +V terminal when remote sensing function is unnecessary) |
| | 3 | -V | Connected to -Output terminal in this Power supply unit. (-V terminal can not supply load current) |
| | 4 | -S | Remote sensing terminal for - output (For remote sensing function, which compensates for line drop between power supply terminals and load terminals. Connect to -V terminal when remote sensing function is unnecessary) |
| | 5 | PC | Current balance terminal (For output current balancing in parallel operation.) |
| | 6 | COM | Ground for PC and PV signal. |
| | 7 | PV | Output voltage external control terminal (For power supply output voltage control with an external voltage. Connect it with the terminal REF when PV function is unnecessary.) |
| | 8 | REF | Reference Voltage terminal for Output voltage control (REF and PV are connected when shipping.) |
| | 9 | CNT | Remote ON/OFF control terminal (When the CNT is pulled to TTL low, the power supply turns on.) |
| | 10 | TOG | Ground for CNT and PF signal. |
| | 11 | PF | Power fail signal output terminal. (As the output voltage drops, FAN stops and AC input voltage down, open collector output, "Power Fail" signal will output "High" .) |
| | 12 | TOG | Ground for CNT and PF signal. |

HWS

CN01, CN02 are connected in this power supply unit as follows.

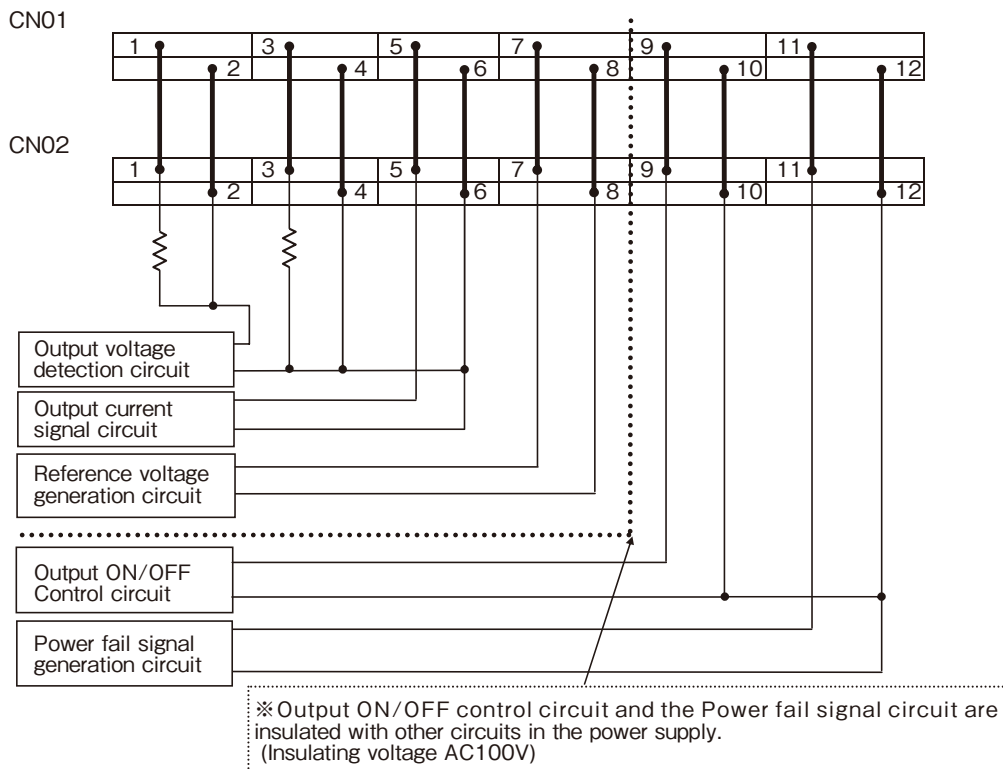

3 Basic Connection (Local sensing)

• 3-7V model

- ① Connect "+S" terminal to "+" terminal of output and "-S" terminal to "-" terminal of output with sensing wires.
 - ② Connect "CNT" terminal to "TOG" terminal with wire.
 - ③ Connect "PV" terminal to "REF" terminal with wire.
- ※ Please use attachment connector for each connection.
 ※ In the following cases, the output is shut down.
 When CNT and TOG is opened.
 When PV and REF is opened.

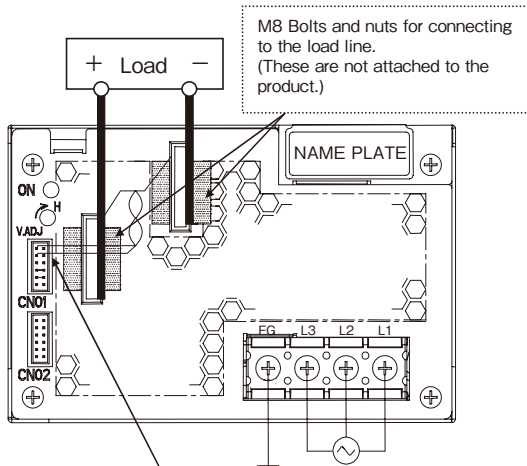

M8 Bolts and nuts for connecting to the load line.
(These are not attached to the product.)

Connector : (JST) S12B-PHDSS

Attached connector when shipping
 ·Housing : (JST) PHDR-12VS
 ·Contact : (JST) SPHD-001T-P0.5
 2-"+" of output, 4-"-" of output are connected.
 7-8, 9-10 are shorted

Attached connector when shipping

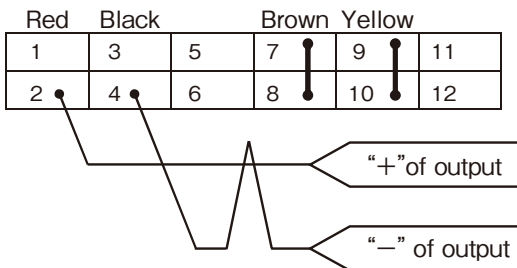

• 12-60V model

- ① Connect "+S" terminal to "+V" terminal and "-S" terminal to "-V" terminal with sensing wires.
 - ② Connect "CNT" terminal to "TOG" terminal with wire.
 - ③ Connect "PV" terminal to "REF" terminal with wire.
- ※ Please use attachment connector for each connection.
 ※ In the following cases, the output is shut down.
 When CNT and TOG is opened.
 When PV and REF is opened.

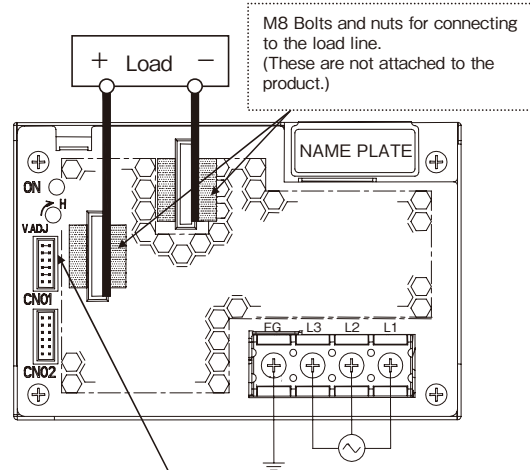

M8 Bolts and nuts for connecting to the load line.
(These are not attached to the product.)

Connector : (JST) S12B-PHDSS

Attached connector when shipping
 ·Housing : (JST) PHDR-12VS
 ·Contact : (JST) SPHD-001T-P0.5
 1-2, 3-4, 7-8, 9-10 are shorted.

Attached connector when shipping

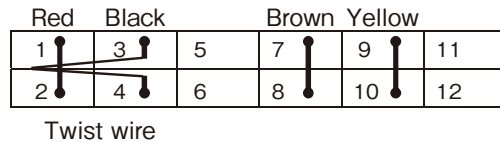

4 Remote sensing required

- ① Connect "+S" terminal to "+" terminal of load with sensing wire
 - ② Connect "-S" terminal to "-" terminal of load with sensing wires.
 - ③ Connect "CNT" terminal to "TOG" terminal with wire.
 - ④ Connect "PV" terminal to "REF" terminal with wire.
- ※ The accuracy of the output voltage will deteriorate when the sensing terminals are opened.
 ※ In the following cases, the output is shut down.
 When CNT and TOG is opened.
 When PV and REF is opened.

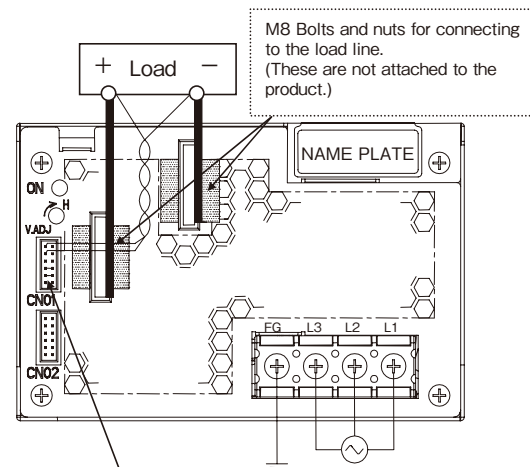

M8 Bolts and nuts for connecting to the load line.
(These are not attached to the product.)

Connector : (JST) S12B-PHDSS

Remove standard attached connector, and use the harness made by the customer.
 ·Housing : (JST) PHDR-12VS
 ·Contact : (JST) SPHD-001T-P0.5
 2-"+" of load, 4-"-" of load should be connected.
 7-8, 9-10 : should be shorted
 * Please use wire for contact and crimping tool specified by maker.

Connecting circuit with CN01 or CN02 connector

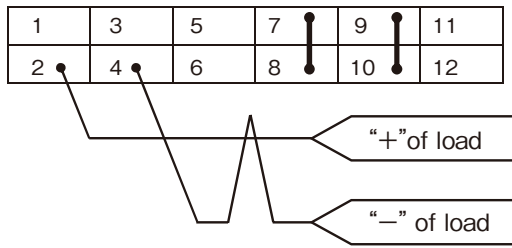

5 Remote ON/OFF control required

- 1 Remove standard attached connector, and use the harness made by the customer and connect external signal to between CNT and TOG terminal.
- 2 "TOG" terminal is ground for "CNT" terminal.
In case this function is not used, please short between CNT and TOG terminal.

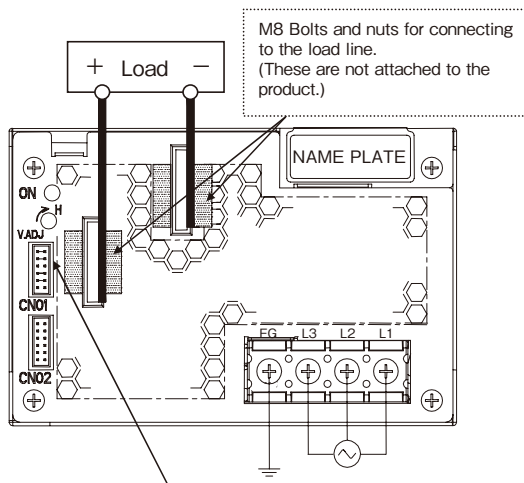

Connector : (JST) S12B-PHDSS

Remove standard attached connector, and use the harness made by the customer.

- Housing : (JST) PHDR-12VS
- Contact : (JST) SPHD-001T-P0.5

(3-7V model) 2- "+" of output, 4- "-" of output : should be connected
(12-60V model) 1-2, 3-4 : should be shorted
7-8 : should be shorted

9 : CNT
Should be connected to ON/OFF control signal.

10 : TOG
Should be connected to Signal Ground.

* Please use wire for contact and crimping tool specified by maker.

Connecting circuit with CN01 or CN02 connector

(3-7V model)

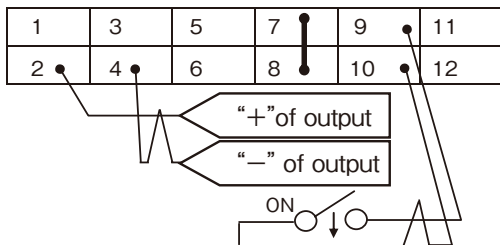

(12-60V model)

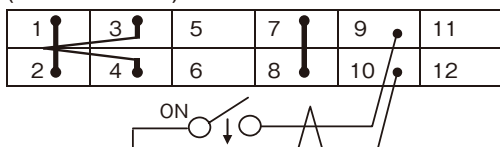

6 PF signal output required

- 1 PF signal is an open collector output, therefore PF signal outputs is shown in circuit below.
- 2 "TOG" terminal is ground for "PF" terminal.

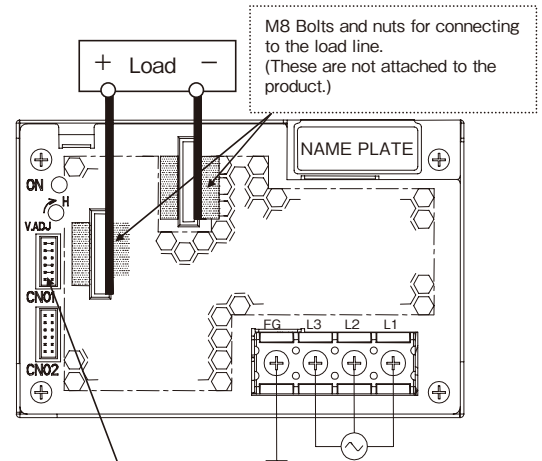

Connector : (JST) S12B-PHDSS

Remove standard attached connector, and use the harness made by the customer.

- Housing : (JST) PHDR-12VS
- Contact : (JST) SPHD-001T-P0.5

(3-7V model) 2- "+" of output, 4- "-" of output : should be connected
(12-60V model) 1-2, 3-4 : should be shorted
7-8, 9-10 : should be shorted.

11 : PF
Should be connected to PF signal output

12 : TOG
Should be connected to Signal Ground.

* Please use wire for contact and crimping tool specified by maker.

Connecting circuit with CN01 or CN02 connector (3-7V model)

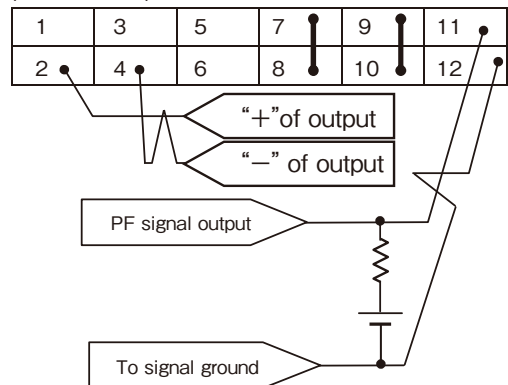

(12-60V model)

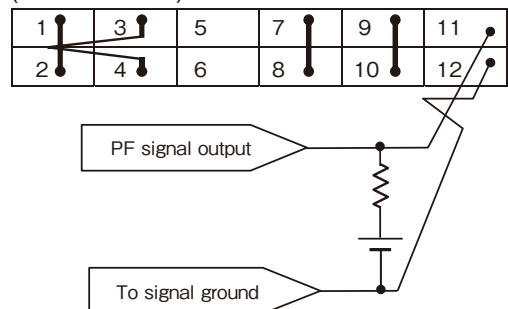

2. Functions and Precautions

1 Input Voltage Range

Input voltage range is three phase 170–265VAC(47–63Hz). Input voltage, which is out of specification, may cause unit damage. Rated input voltage range fix during safety standard application is from 200V to 240VAC (50/60Hz).

2 Output Voltage Range

Output voltage is set to the rated value at shipping. V.ADJ trimmer on the front panel side is use to adjust the output voltage within the range specified. Output voltage trimming range is within -20% – +20% of the rated output voltage (48V, 60V model: -20% – +10%). Turn the trimmer clockwise to increase output voltage. Take note when the output voltage is increased excessively over voltage protection (OVP) function may trigger and output voltage will shut down.

Use the output power of the power supply below the rated output power value when you raise the output voltage.

3 Over Voltage Protection (OVP)

The OVP function (Inverter shut down method, manual reset type) is provided. OVP function operates within 125-145% of the rated DC output voltage value (3-7V model: 125-140%, 36V model: 125-138%, 48V, 60V model: 115-125%), and the output will be shut down when OVP function triggers. When OVP function operates, the input power is cut off for a few minutes, and then power is re-input or remote ON/OFF control signal shall be input for recovery of the output. OVP value is fixed and can not be adjusted.

4 Over Current Protection (OCP)

The OCP function (Constant current limiting, Time delay shutdown type) is provided. OCP function operates when the output current exceeds 105% of maximum DC output current specification and the over current or short circuit condition continues 5-second or more, the output will be shut down. When the OCP is triggered, the input power is cut off for a few minutes, and then power is re-input or remote ON/OFF control signal should be input for recovery of the output. The OCP setting is fixed and not to be adjusted externally.

5 Over Temperature Protection (OTP)

Over temperature protection function (manual reset type) is provided. When ambient or internal temperature rises abnormally, OTP will shut down the output. When OTP is triggered, input power is cut off and allow sufficient cooling to reset the OTP function. Then power is re-input or remote ON/OFF control signal should be input for recovery of the output.

6 Low Output Detection Circuit (PF)

Low output voltage detection circuit is provided. Power Fail signal (PF signal) will output when output voltage decrease by either the drop or brown out of the input voltage or OCP, OVP and OTP function operation. PF signal will turn "High" level to indicate the abnormal status

of the power supply when the output voltage decrease to 80% of the output voltage setting value. However, there is a possibility that PF signal may not output during parallel operation. The PF signal circuit is insulated from the power supply input and output circuit and it is an open collector. TOG terminal is ground for PF terminal.

When the Built-in Fan Motor of this power supply unit stops, PF signal will turn to "H" and the output power will shut down. The Built-in Fan Motor is a component with lifetime. We recommend a periodic replacement. Please contact our sales office. Replacement is at customer's expenses.

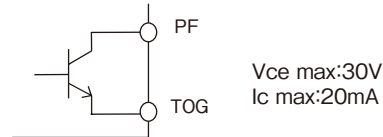

7 Remote Sensing (+S, -S terminal)

Remote sensing function is provided to compensate for voltage drop across the wiring from the power supply output terminals to the load input terminals. Connect "+S" terminal to "+" terminal of the load and "-S" terminal to "-" terminal of the load with sensing wires. The total line voltage drop (+ side line and - side line) shall be less than 0.3V. In case that sensing line is too long, it is necessary to put an electrolytic capacitor across the load terminals.

Please take note that the electrolytic capacitor has generation of heat etc. done by the ripple current depending on connected load. Therefore, the electrolytic capacitor must have a ripple current allowance higher than the output ripple current. If CN01 (or CN02) is in use, terminal +S, -S for CN02 (or CN01) must be in open condition.

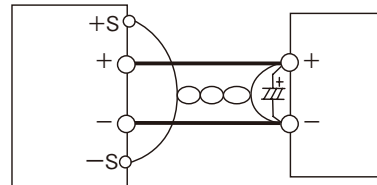

When the function of remote sensing is not in used, connect +S terminal to +V terminal, and -S terminal to -V terminal by the attachment connector.

If remote sensing terminals are opened, the stability and the accuracy of the output deteriorate. Therefore, terminal +S, -S must be connected.

8 Remote ON/OFF Control

Remote ON/OFF control is provided. Output can be remotely switch ON and OFF by using CNT terminal and TOG terminal even though input is connected. The output is turned to ON when TOG and CNT terminals are shorted and output is turned to OFF when these terminals are opened. When the function is not used, connect TOG and CNT terminals with short piece. The standards for this function are as follows. "TOG" terminal is ground for "CNT" terminal.

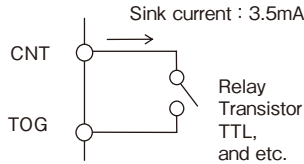

The Mode of control

| CNT Level for TOG Terminal | Output | Built-in Fan Motor |
|----------------------------|--------|--------------------|
| Short or L (0-0.8V) | ON | Rotate |
| Open or H (2.4-12V) | OFF | Stop |

- 1) TTL compatible. The maximum input voltage to CNT terminal is 12V, and the maximum allowable reverse voltage is -1V. The sink current of CNT terminal is 3.5mA.
- 2) Output ON/OFF control can be enable by a switch, relay or a transistor ON/OFF. When CNT terminal-TOG terminal is shorted power supply is turn ON, and when CNT terminal-TOG terminal is opened power supply is turn OFF.
- 3) Remote ON/OFF control circuit is isolated from the input and output circuit of power supply.

It is possible to use it regardless of the positive and negative of the power supply output.

Please be aware that if CNT terminal and TOG terminal is short and input voltage is gradually increase, this will trigger the low output voltage detector protection circuit and will result to output voltage shut down. When the low output voltage detector protection circuit is triggered, the input power is cut off for a few minutes, and then power is re-input or remote ON/OFF control signal should be input for recovery of the output.

9 Output Ripple & Noise

Maximum ripple & noise value in specifications is measured according to measurement circuit specified by JEITA-RC9131A. When Load lines are longer, ripple & noise becomes larger. In this case, electrolytic capacitor, film capacitor, etc. might be necessary to use across the load terminal. The output ripple & noise cannot be measured accurately if the probe ground lead of oscilloscope is too long.

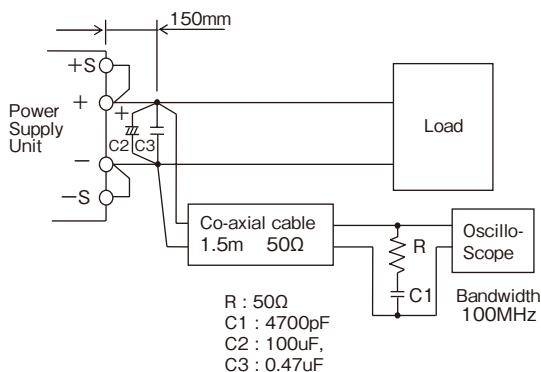

10 Series Operation

For series operation, either method (A) or (B) is possible. There might be a step in the rise waveform during series operation.

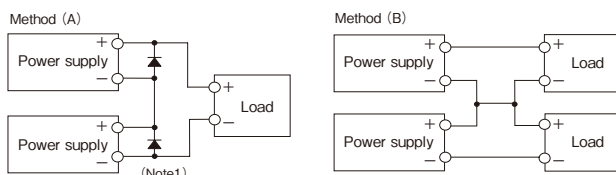

(Note1) Please connect a diode for by-pass when using method (A) of the series operation. Please use the diode with rated forward current is equal or more than load current and that the rated maximum reverse voltage is higher than output voltage for each power supply.

11 Parallel Operation

Current balancing function is provided. Either of operations mode (A) or (B) is possible.

(A) To Increase the Output Current

Current balancing function activates by connecting PC-to-PC terminal and COM-to-COM terminal, and output current of each power supply is equivalently supplied to load. Wires to PC terminals shall be as short as possible, same length and twisted.

There is a possibility that output could be unstable caused by external noise. For this case, disconnect COM terminal and connect -S terminal from parallel power supply to a single point on the load. Please refer connection Method (A)-2.

- 1) Adjust the output voltage of each power supply to be same value within 1% or 100mV, whichever is smaller.
- 2) Use same length and type of wires for all load lines.
- 3) Maximum value of output current in parallel is up to 80% of all paralleled models. The purpose of the current balancing function is the static power-up. Therefore the output voltage might decrease according to the condition of dynamic load. There might be a step in the rise waveform during parallel operation.
- 4) Up to 5 units can be connected in parallel.

(B) To Use as a Backup Power Supply

- 1) Set power supply output voltage higher by the forward voltage drop of diode.
- 2) Adjust the output voltage of each power supply to be same value.
- 3) Use within the specifications for output voltage and output power.

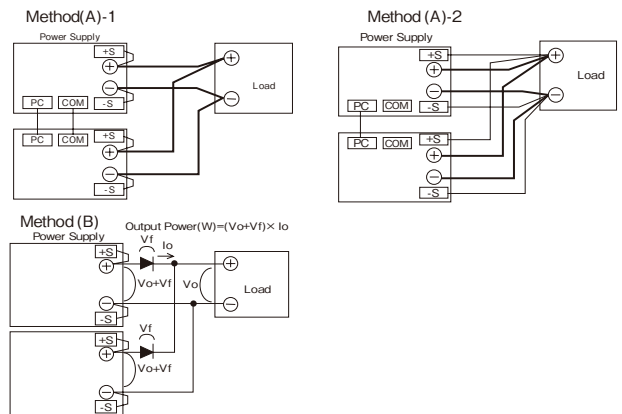

12 Isolation Test

Isolation resistance between output and FG (chassis) shall be more than 100Ω at 500VDC and between output and CNT·PF shall be more than 10MΩ at 100VDC. For safety operation, voltage setting of DC isolation tester must be done before the test. Ensure that it is fully discharged after the test.

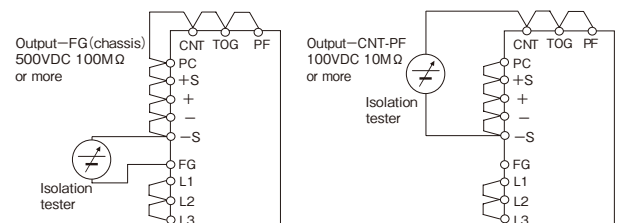

13 Withstand Voltage

This series is designed to withstand 3.0kVAC between input and output, 2.0kVAC between input and FG (chassis), 500VAC (60V model: 651VAC) between output and FG (chassis), and 100VAC between output and CNT·PF terminal each for 1 minute. When testing withstand voltage, set current limit of withstand voltage test equipment at 20mA.

(Output-FG (chassis): 300mA (60V model: 390mA), Output- CNT·PF : 100mA).

The applied voltage must be gradually increased from zero to testing value and then gradually decreased for shut down. When timer is used, the power supply may be damaged by high impulse voltage at timer switch on and off. Connect input and output as follows. If output is left open during test, output voltage might appear momentarily.

This product have monolithic ceramic capacitor in secondary circuit to frame ground.

Some of the withstand voltage tester may generate high voltage at the matching with monolithic ceramic capacitor and may cause the unit damage.

So, please check the waveform of test voltage.

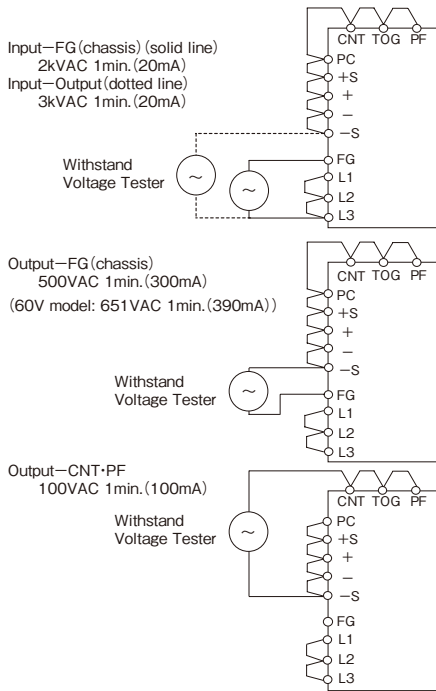

14 Output Voltage External Control (PV)

(A) Control by External Voltage

Output voltage external control function is provided. Output voltage can be varied by applying an external voltage (1-6V) to "PV" terminal and "COM" terminal. Note if an external voltage is not applied, there will be no output. Please consider the following characteristics below when operating the unit.

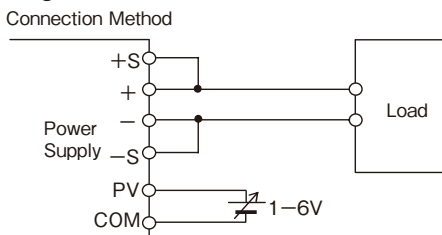

Output Voltage Linearity

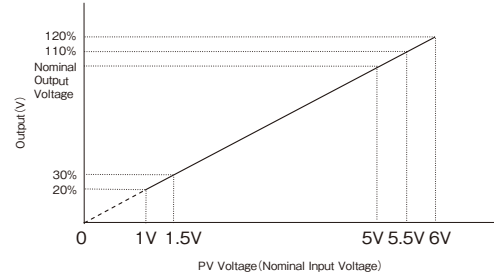

Note: Only as for the model of 3V output, the output voltage is used from 30% to 120% at the PV voltage is from 1.5V to 6V

Note: Only as for the model of 5-36V output, the output voltage is used from 20% to 120% at the PV voltage is from 1V to 6V

Note: Only as for the model of 48V, 60V output, the output voltage is used from 20% to 110% at the PV voltage is from 1V to 5.5V

Output Voltage Derating

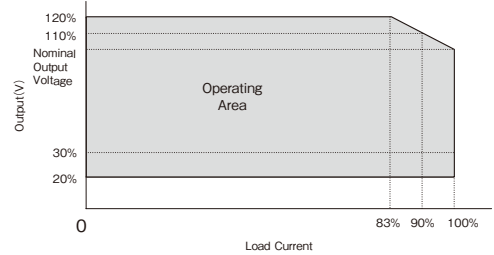

Note: Only as for the model of 48V, 60V output, the maximum output voltage is used up to 110% at 90% load current.

* Output voltage usage below 20% (3V type: 30%) is not a guaranteed. There is a possibility that it cannot be use with certain product. Please conduct a thorough evaluation test before using it.

(B) Control by External Variable Resistor

"PV" terminal and "COM" terminal usage is the same as explained in section [control by external voltage] . But in this method voltage for control is supplied through REF terminal. Variable resistor is connected between REF terminal and COM terminal and the middle point of variable resistor is connected to PV terminal. Please use the output voltage within 20% - 120% of rated output voltage value (48V, 60V model: 20% - 110%). Wires for control lines must be twisted wire or shield wire. In addition, maximum variable voltage when control by external variable resistor is rated output voltage (100%). When output voltage must be externally control to 120% of rated output voltage (110% for 48V, 60V model), please follow the following procedure.

- (1) PV terminal and REF terminal is short by using standard connector supplied.
- (2) Set the power supply output voltage to maximum value of the output voltage variable range mentioned in specification standard by adjusting V.ADJ volume at the front panel.
- (3) Remove standard connector after input is cut off.
- (4) Connect external variable resistor (50kΩ) between REF terminal and COM terminal. Then connect middle point of external variable resistor to PV terminal.(sensing current is 1.4mA)

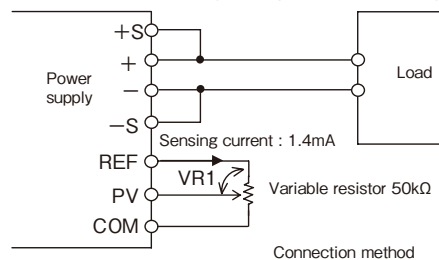

When output voltage is over rated value, please make sure that maximum output power is below rated value. Moreover, when output voltage is below rated value, please make sure that maximum output current is below rated value.

Please consider the following characteristic during usage.

Please consider the following characteristic during usage.

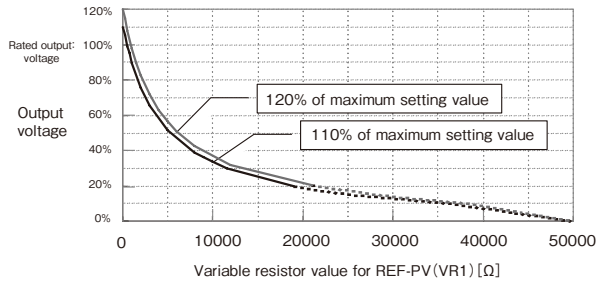

* Output voltage usage below 20% (3V model: 30%) is not a guaranteed. There is a possibility that it cannot be use with certain product. Please conduct a thorough evaluation test before using it.

15 Output Peak Current

For model with output peak current, please meet the following condition.

Reduce peak current value according to output derating as section 4-1.

The output is shut down by protection circuit when rated current and continuous peak output time (τ) exceeds rated value during usage.

When protection circuit is activated, input is temporarily cut off for a few minutes and then power is re-input or remote ON/OFF control signal should be input for recovery of the output.

- Continuous Peak output time. (τ) : Within 10 seconds
- Peak output current (I_p) : Within the rated peak output current
- Duty : up to 35%

$$\text{Duty} = \frac{\tau}{T} \times 100 (\%)$$

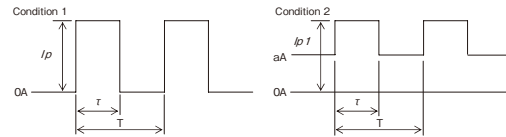

$$\sqrt{I_p^2 \times \frac{\tau}{T}} \leq I_{rms \max}$$

$$\sqrt{I_p^2 \times \frac{\tau}{T} + a^2 \times (1 - \frac{\tau}{T})} \leq I_{rms \max}$$

| Model | I _{rms max} |
|-------------|----------------------|
| HWS1800T-6 | 177.5A |
| HWS1800T-7 | 142.0A |
| HWS1800T-12 | 88.7A |
| HWS1800T-15 | 71.0A |
| HWS1800T-24 | 62.1A |
| HWS1800T-36 | 41.4A |
| HWS1800T-48 | 31.0A |
| HWS1800T-60 | 24.8A |

- I_p, I_{p1} : Peak output current (A)
- I_{av} : Rated output current (A)
- I_m : Average output current (A)
- τ : Peak current pulse width (sec)
- T : cycle (sec)

16 Input Open Phase Detection

If one of the 3-phase input line becomes open or one phase voltage falls below 160VAC, the output will be shut off in approximately 3 seconds. To restore the output to normal, shut off the input once, and apply a normal input line voltage again after for a while.

3. Mounting Directions

1 Output Derating

Mounting directions are as follows.

Standard mounting method is (A). Methods (B), (C) and (D) are also possible.

Mounting methods besides (A),(B),(C) and (D) (example : (E) and (F)) are inhibit.

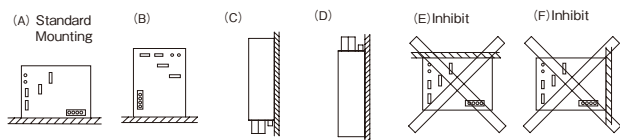

HWS1800T 3V Output Derating

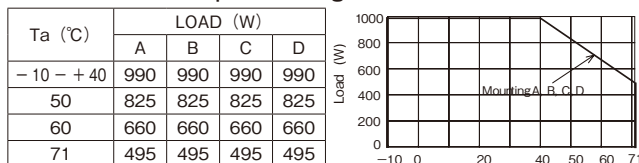

HWS1800T 5V Output Derating

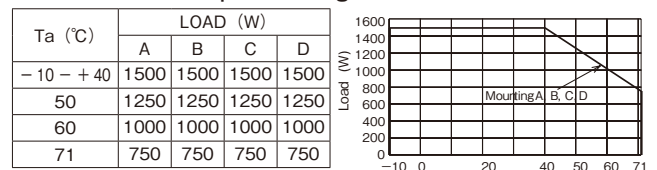

HWS1800T 6V-15V Output Derating

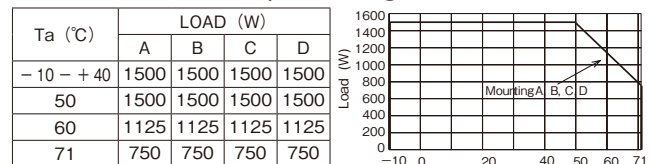

HWS1800T 24V-60V Output Derating

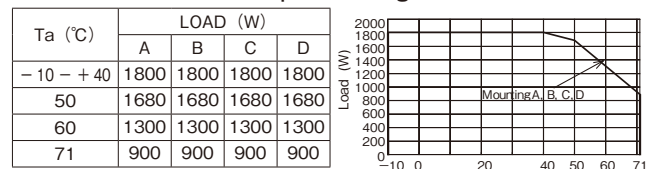

2 Mounting Method Caution

- (1) This Power supply unit is a forced air-cooling system with a built-in fan.
- (2) This power supply has ventilating holes on the front and back panels.
Keep these areas freely more than 100mm from front side and more than 50mm from rear side.
- (3) Please note that ventilation will be worsened in a dusty environment.
- (4) Built-in fan is limited life part, which require periodic replacement. (Replacement will be charge).
- (5) The ambient temperature of this power supply is less than 50mm from the center of a front side.
- (6) The maximum allowable penetration of mounting screw is 6mm.
- (7) Recommended torque for mounting screw (M4) is 1.27N · m.

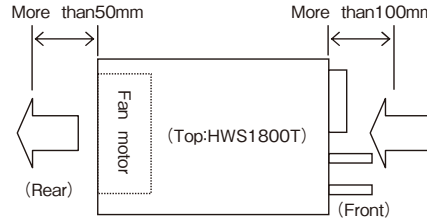

HWS

4. Wiring Method

- (1) The output load line and input line shall be separated and twisted to improve noise sensitivity.
- (2) The sensing lines shall be twisted or shield wire and separated from the output lines.
- (3) Use all lines as thick and short as possible to make lower impedance. Wires are to be twisted or use shield wire to improve noise sensitivity.
- (4) Attaching a capacitor to the load terminals can eliminate noise.
- (5) FG terminal of this power supply is functional earthing. For safety purposes, connect protective earthing terminal to the mounting set ground terminal.
- (6) Recommended torque for the terminal piece:

Input terminal (M4 screw) : 1.27 N · m
Output terminal (M8 Bolt & Nut) : 10.8N · m

(7) Recommended wiring

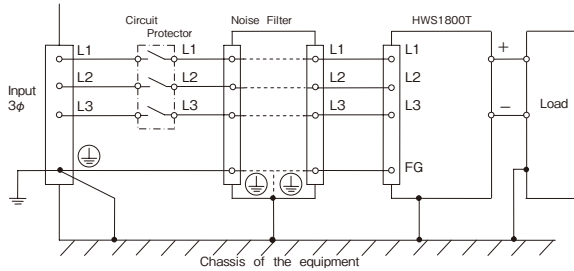

Recommended circuit protector : AC250V20A
Recommended noise filter : MC1320 (DENSEI-LAMBDA)

- (8) M4 screw for output terminal might damage the terminal's inner thread. This is mainly cause by the M4 screw's unthread section. Therefore, please select a washer, spring washer, etc. to avoid unthread screw section from penetrating into output terminal inner section.

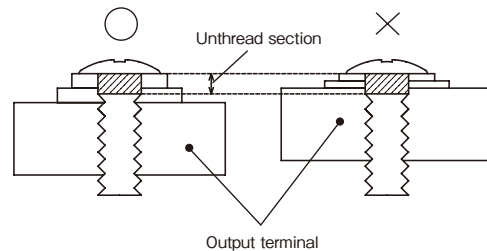

5. External Fuse Rating

Refer to the following fuse rating when selecting the external fuses for input line. Surge current flows when line turns on. Use slow-blow fuse or time-lag fuse. Do not use fast-blow fuse. Fuse rating is specified by in-rush current value at line turn-on. Do not select the fuse according to input

current (rms.) values under the actual load condition.

HWS1800T : 20A

6. Troubleshooting

Before concluding that the unit is at fault, make the following checks.

- (1) Check if the rated input voltage is apply.
- (2) Check if the wiring of input and output is correct.
- (3) Check if the I/O terminal connection is properly tight- en by a regulated tightening torque.
- (4) Check if the wire material is not too thin.
- (5) Check if the output voltage control (V.ADJ) is properly adjusted. OVP might be trigged and output is cut off.
- (6) Check if the wiring of "+S" and "-S" terminal is cor- rect. If in open condition, when input voltage is apply, OVP is trigged and output is cut off. Output display LED will turn on for a moment.
- (7) If use function of the remote ON/OFF control, check if the remote ON/OFF control connector is not opened. If in open condition, output is cut off.
- (8) Check if the built-in fan is not stopped. Is fan stopped by something irregulars or dust, etc. If fan stops, the PF signal is turn on.

Moreover, the output is intercepted with the protection circuit if fan stops.

Fans are the limited life parts.

This power supply has ventilating holes on the front and back panels. Check if there is any irregulars or dust, etc.

- (9) Is the main body of the power supply abnormally hot? Please turn on the input again after allowing the unit to cool down sufficiently. The output shut down by over temperature protection function.
- (10) Check if the output current and output power is not applied over specification.
- (11) Check if the input voltage wave is sinusoidal. If this power supply unit is connected to a UPS, input voltage wave might not be sinusoidal. An audible noise is emmitted from the power supply unit.
- (12) Audible noise can be heard during Dynamic-Load operation.

HWS

7. Warranty

This product is warranted for a period of 5 years from the date of shipment. As for the breakdown under a normal use during free warrantee term, repair is at free of charge. However, the Built-in Fan Motor replacement is for a fee. Please contact your nearest sales office for replacement. The Fan-life has limitation. Therefore, periodic mainte- nance by replacing the life-expired fan is required. The following figure shows the life of fan.

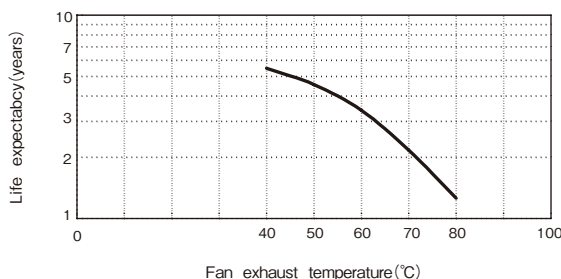

Life expectancy

| | | |
|-------------------------|------|-------------|
| Fan exhaust temperature | 45°C | 45,000 hour |
| Fan exhaust temperature | 80°C | 11,000 hour |

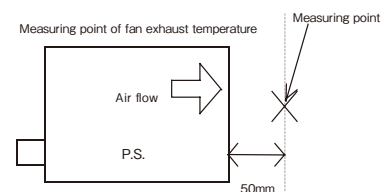

Conditions of usage at the free of charge warrantee are as follows.

- (1) Average operating temperature (ambient temperature of the power supply unit) is 40°C
- (2) Average load factor is 80% or less
- (3) Installation method: Standard installation. However, the maximum rating is within the output derating.

Following cases are not covered by warranty.

- (1) Improper usage like dropping products, applying shock and defects from operation exceeding specification of the units.
- (2) Defects resulting from natural disaster (fire, flood).
- (3) Unauthorized modifications or repair by the buyers.
- (4) Defects not cause by DENSEI LAMBDA.

8. Option

1 Fan unit for replacement

We have prepared an optional fan unit for replacement.

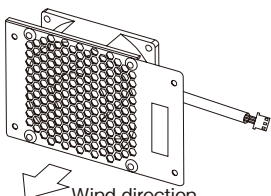
| Name of fan unit for replacement | Applicable models | Appearance | Pin assignments | Price | | | | | | | | |
|----------------------------------|---|---|---|---------|-------------|---|--------------|---|-----------|---|-----|------|
| 1500-FAN-01 | HWS1500 HWS1800T (of standard specifications) |  | Housing = XHP-3(J.S.T.) Contact = SXH-001T-P0.6(J.S.T.) <table border="1" style="margin-left: 20px;"> <thead> <tr> <th>Pin No.</th> <th>Description</th> </tr> </thead> <tbody> <tr> <td>1</td> <td>Power supply</td> </tr> <tr> <td>2</td> <td>Fan alarm</td> </tr> <tr> <td>3</td> <td>GND</td> </tr> </tbody> </table> Length of fan harness = 65 ± 10mm | Pin No. | Description | 1 | Power supply | 2 | Fan alarm | 3 | GND | Open |
| Pin No. | Description | | | | | | | | | | | |
| 1 | Power supply | | | | | | | | | | | |
| 2 | Fan alarm | | | | | | | | | | | |
| 3 | GND | | | | | | | | | | | |

Ask us for replacement of the fan. This will be a charged service. If you are replacing the fan by yourself, note the following.

- *1. Be careful in handling the fan unit so as not to cause an impact by dropping it or hitting it, etc.
- *2. Shut down the input before starting the replacement operation.
- *3. Check that there are no loose parts in connectors or harness tucking, etc.
- *4. Safety standards (UL, CE, etc.) are not applicable.

• All specifications are subject to change without notice.

TDK-Lambda