

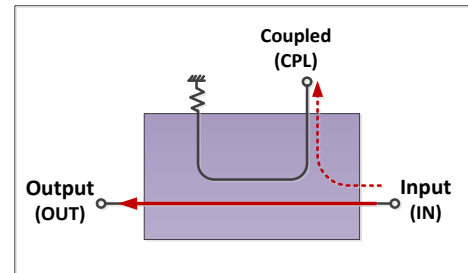

Electrical schematic



RoHS Compliant

Electrical Specifications

| Parameter | Unit | Frequency (GHz) | Min. | Typ. | Max. |
|------------------------------------------|------|-----------------|------|------|------|
| Nominal Coupling | dB | 1 – 20 | 9 | 10 | 11 |
| Coupling Flatness | | | ±0.6 | ±1.0 | |
| Directivity | | | 15 | 20 | |
| Main Line VSWR | :1 | 1 – 8 | | 1.15 | 1.25 |
| | | 8 – 20 | | 1.25 | 1.35 |
| Coupled Line VSWR | | 1 – 8 | | 1.15 | 1.25 |
| | | 8 – 20 | | 1.30 | 1.40 |
| Insertion Loss (Including Coupling Loss) | dB | 1 – 20 | | 1.6 | 1.9 |
| Average Power Handling | W | 1 – 20 | | | 20 |

Operated in 50Ω system, 25°C environment.

Outline Drawing

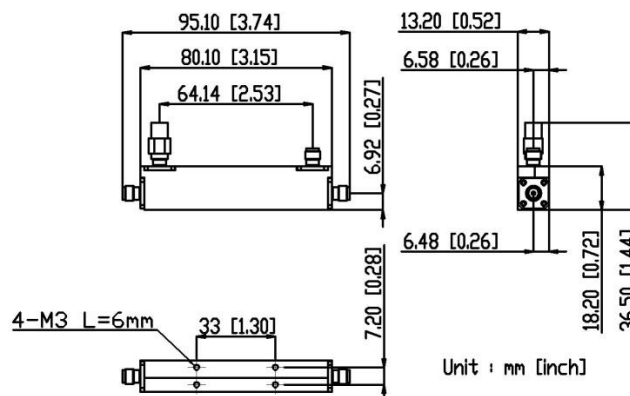

Connectors: SMA Female

Typical Performance

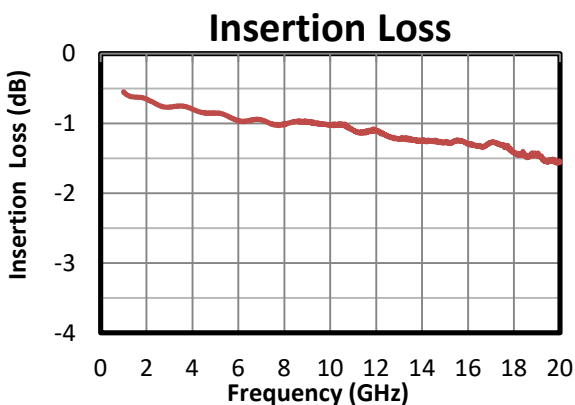
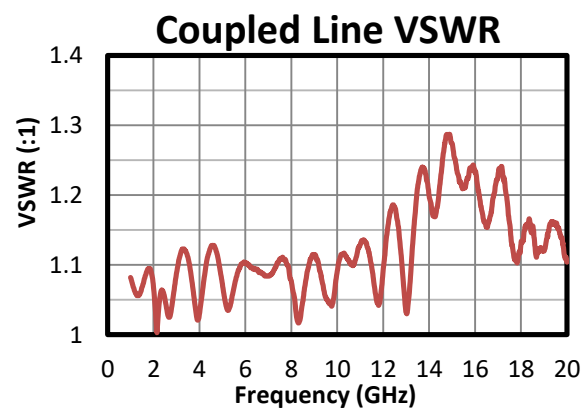
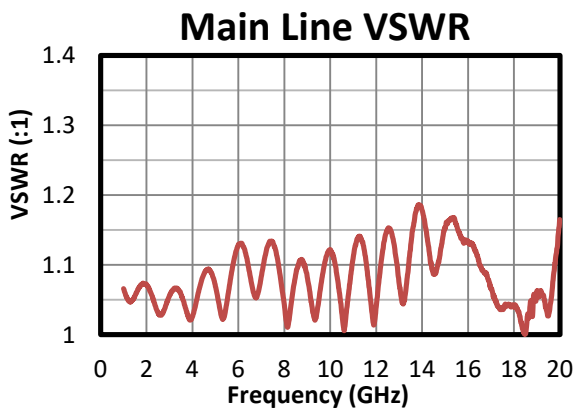
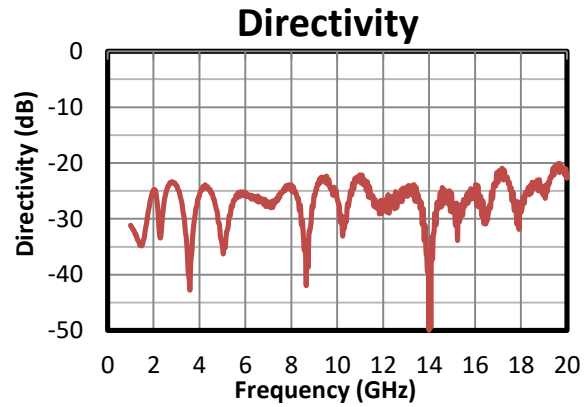
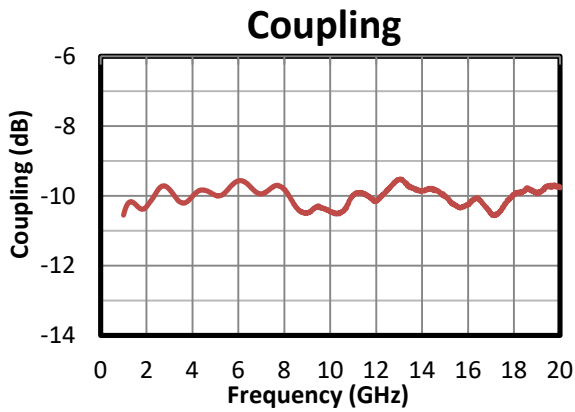

Typical performance S-parameter file: <https://www.amtery.com/en/goods-59>

For each S/N S-parameter file, go to <https://www.amtery.com/en/downloads>

Note: Specifications are subject to change without notice.