



MICROCHIP

**MPLAB[®] Starter Kit for
Intelligent.Integrated.Analog
User's Guide**

Note the following details of the code protection feature on Microchip devices:

- Microchip products meet the specification contained in their particular Microchip Data Sheet.
- Microchip believes that its family of products is one of the most secure families of its kind on the market today, when used in the intended manner and under normal conditions.
- There are dishonest and possibly illegal methods used to breach the code protection feature. All of these methods, to our knowledge, require using the Microchip products in a manner outside the operating specifications contained in Microchip's Data Sheets. Most likely, the person doing so is engaged in theft of intellectual property.
- Microchip is willing to work with the customer who is concerned about the integrity of their code.
- Neither Microchip nor any other semiconductor manufacturer can guarantee the security of their code. Code protection does not mean that we are guaranteeing the product as "unbreakable."

Code protection is constantly evolving. We at Microchip are committed to continuously improving the code protection features of our products. Attempts to break Microchip's code protection feature may be a violation of the Digital Millennium Copyright Act. If such acts allow unauthorized access to your software or other copyrighted work, you may have a right to sue for relief under that Act.

Information contained in this publication regarding device applications and the like is provided only for your convenience and may be superseded by updates. It is your responsibility to ensure that your application meets with your specifications. MICROCHIP MAKES NO REPRESENTATIONS OR WARRANTIES OF ANY KIND WHETHER EXPRESS OR IMPLIED, WRITTEN OR ORAL, STATUTORY OR OTHERWISE, RELATED TO THE INFORMATION, INCLUDING BUT NOT LIMITED TO ITS CONDITION, QUALITY, PERFORMANCE, MERCHANTABILITY OR FITNESS FOR PURPOSE. Microchip disclaims all liability arising from this information and its use. Use of Microchip devices in life support and/or safety applications is entirely at the buyer's risk, and the buyer agrees to defend, indemnify and hold harmless Microchip from any and all damages, claims, suits, or expenses resulting from such use. No licenses are conveyed, implicitly or otherwise, under any Microchip intellectual property rights.

Trademarks

The Microchip name and logo, the Microchip logo, dsPIC, FlashFlex, KEELOQ, KEELOQ logo, MPLAB, PIC, PICmicro, PICSTART, PIC³² logo, rPIC, SST, SST Logo, SuperFlash and UNI/O are registered trademarks of Microchip Technology Incorporated in the U.S.A. and other countries.

FilterLab, Hampshire, HI-TECH C, Linear Active Thermistor, MTP, SEEVAL and The Embedded Control Solutions Company are registered trademarks of Microchip Technology Incorporated in the U.S.A.

Silicon Storage Technology is a registered trademark of Microchip Technology Inc. in other countries.

Analog-for-the-Digital Age, Application Maestro, BodyCom, chipKIT, chipKIT logo, CodeGuard, dsPICDEM, dsPICDEM.net, dsPICworks, dsSPEAK, ECAN, ECONOMONITOR, FanSense, HI-TIDE, In-Circuit Serial Programming, ICSP, Mindi, MiWi, MPASM, MPF, MPLAB Certified logo, MPLIB, MPLINK, mTouch, Omniscient Code Generation, PICC, PICC-18, PICDEM, PICDEM.net, PICkit, PICtail, REAL ICE, rLAB, Select Mode, SQI, Serial Quad I/O, Total Endurance, TSHARC, UniWinDriver, WiperLock, ZENA and Z-Scale are trademarks of Microchip Technology Incorporated in the U.S.A. and other countries.

SQTP is a service mark of Microchip Technology Incorporated in the U.S.A.

GestIC and ULPP are registered trademarks of Microchip Technology Germany II GmbH & Co. KG, a subsidiary of Microchip Technology Inc., in other countries.

All other trademarks mentioned herein are property of their respective companies.

© 2013, Microchip Technology Incorporated, Printed in the U.S.A., All Rights Reserved.

 Printed on recycled paper.

ISBN: 978-1-62077-268-3

**QUALITY MANAGEMENT SYSTEM
CERTIFIED BY DNV
= ISO/TS 16949 =**

Microchip received ISO/TS-16949:2009 certification for its worldwide headquarters, design and wafer fabrication facilities in Chandler and Tempe, Arizona; Gresham, Oregon and design centers in California and India. The Company's quality system processes and procedures are for its PIC[®] MCUs and dsPIC[®] DSCs, KEELOQ[®] code hopping devices, Serial EEPROMs, microperipherals, nonvolatile memory and analog products. In addition, Microchip's quality system for the design and manufacture of development systems is ISO 9001:2000 certified.

Object of Declaration: DM240015, MPLAB® Starter Kit for Intelligent.Integrated.Analog

EU Declaration of Conformity

This declaration of conformity is issued by the manufacturer.

The development/evaluation tool is designed to be used for research and development in a laboratory environment. This development/evaluation tool is not a Finished Appliance, nor is it intended for incorporation into Finished Appliances that are made commercially available as single functional units to end users under EU EMC Directive 2004/108/EC and as supported by the European Commission's Guide for the EMC Directive 2004/108/EC (8th February 2010).

This development/evaluation tool complies with EU RoHS2 Directive 2011/65/EU.

For information regarding the exclusive, limited warranties applicable to Microchip products, please see Microchip's standard terms and conditions of sale, which are printed on our sales documentation and available at www.microchip.com.

Signed for and on behalf of Microchip Technology Inc. at Chandler, Arizona, USA

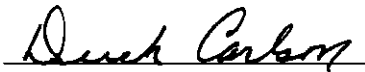

Derek Carlson
VP Development Tools

02-May-12
Date

NOTES:



MPLAB® STARTER KIT FOR INTELLIGENT.INTEGRATED.ANALOG USER'S GUIDE

Table of Contents

Preface	7
Chapter 1. Introduction to the Starter Kit	
1.1 Overview	13
1.2 What's in the Kit	14
1.3 Hardware	14
1.4 Installing Device Drivers for the Starter Kit	18
Chapter 2. The Demonstration Application	
2.1 Start-up Display	19
2.2 Sections of the Demo	19
2.3 Other Hardware Resources on the Starter Kit	23
Chapter 3. Developing New Applications	
3.1 Reprogramming the Starter Kit Using the PKOB	25
3.2 Hardware Considerations for New Applications	27
Chapter 4. Troubleshooting	29
Appendix A. Starter Kit Schematics	31
Appendix B. LCD Panel Information	35
Appendix C. Optional Microphone Amplifier	39
Index	41
Worldwide Sales and Service	42

NOTES:



MPLAB® STARTER KIT FOR INTELLIGENT.INTEGRATED.ANALOG USER'S GUIDE

Preface

NOTICE TO CUSTOMERS

All documentation becomes dated, and this manual is no exception. Microchip tools and documentation are constantly evolving to meet customer needs, so some actual dialogs and/or tool descriptions may differ from those in this document. Please refer to our web site (www.microchip.com) to obtain the latest documentation available.

Documents are identified with a “DS” number. This number is located on the bottom of each page, in front of the page number. The numbering convention for the DS number is “DSXXXXXXXXXA”, where “XXXXXXXXX” is the document number and “A” is the revision level of the document.

For the most up-to-date information on development tools, see the MPLAB® IDE online help. Select the Help menu, and then Topics to open a list of available online help files.

INTRODUCTION

This chapter contains general information that will be useful to know before using the MPLAB Starter Kit for Intelligent.Integrated.Analog. Items discussed in this chapter include:

- [Document Layout](#)
- [Conventions Used in this Guide](#)
- [Warranty Registration](#)
- [Recommended Reading](#)
- [The Microchip Web Site](#)
- [Development Systems Customer Change Notification Service](#)
- [Customer Support](#)
- [Revision History](#)

Note: Format limitations do not permit the use of the full Starter Kit name in the page headers in this document. All references to the “MPLAB Starter Kit for PIC24F Integrated Analog” throughout this document are understood to refer to the “MPLAB Starter Kit for Intelligent.Integrated.Analog”.

DOCUMENT LAYOUT

This document describes how to use the MPLAB Starter Kit for Intelligent.Integrated.Analog as a development tool to emulate and debug firmware on a target board, as well as how to program devices. The document is organized as follows:

- **Chapter 1. “Introduction to the Starter Kit”** provides a brief overview and hardware description of the Starter Kit.
- **Chapter 2. “The Demonstration Application”** describes the Starter Kit's preprogrammed application.
- **Chapter 3. “Developing New Applications”** describes the important programming and hardware considerations when developing new Starter Kit applications.
- **Chapter 4. “Troubleshooting”** describes common issues and their solutions.
- **Appendix A. “Starter Kit Schematics”** provides detailed schematics for the Starter Kit.
- **Appendix B. “LCD Panel Information”** provides technical details about the custom Microchip LCD panel.
- **Appendix C. “Optional Microphone Amplifier”** describes the optional microphone amplifier for use in voice applications.

CONVENTIONS USED IN THIS GUIDE

This manual uses the following documentation conventions:

DOCUMENTATION CONVENTIONS

Description	Represents	Examples
Arial font:		
Italic characters	Referenced books	<i>MPLAB[®] IDE User's Guide</i>
	Emphasized text	...is the <i>only</i> compiler...
Initial caps	A window	the Output window
	A dialog	the Settings dialog
	A menu selection	select Enable Programmer
Quotes	A field name in a window or dialog	"Save project before build"
Underlined, italic text with right angle bracket	A menu path	<u><i>File>Save</i></u>
Bold characters	A dialog button	Click OK
	A tab	Click the Power tab
Text in angle brackets < >	A key on the keyboard	Press <Enter>, <F1>
Courier New font:		
Plain Courier New	Sample source code	#define START
	Filenames	autoexec.bat
	File paths	c:\mcc18\h
	Keywords	_asm, _endasm, static
	Command line options	-Opa+, -Opa-
	Bit values	0, 1
	Constants	0xFF, 'A'
Italic Courier New	A variable argument	<i>file.o</i> , where <i>file</i> can be any valid filename
Square brackets []	Optional arguments	mcc18 [options] <i>file</i> [options]
Curly brackets and pipe character: { }	Choice of mutually exclusive arguments; an OR selection	errorlevel {0 1}
Ellipses...	Replaces repeated text	var_name [, var_name...]
	Represents code supplied by user	void main (void) { ... }

WARRANTY REGISTRATION

Please complete the enclosed Warranty Registration Card and mail it promptly. Sending in the Warranty Registration Card entitles users to receive new product updates. Interim software releases are available at the Microchip web site.

RECOMMENDED READING

This user's guide describes how to use the MPLAB Starter Kit for Intelligent.Integrated.Analog. Other useful documents are listed below. The following Microchip documents are available and recommended as supplemental reference resources.

Readme Files

For the latest information on using other tools, read the tool-specific Readme files in the Readmes subdirectory of the MPLAB IDE installation directory. The Readme files contain update information and known issues that may not be included in this user's guide.

PIC24F Family Reference Manual

This reference manual explains the operation of the PIC24F microcontroller family architecture and peripheral modules. The specifics of each device family are discussed in the individual family's device data sheet.

This useful manual is online in sections at the Technical Documentation section of the Microchip web site. Refer to these sections for detailed information on PIC24F device operation.

PIC24FJ128GC010 Device Data Sheet (DS30009312) and Flash Programming Specification (DS39970)

Refer to this device data sheet for device-specific information and specifications. Also, refer to the appropriate device flash programming specification for information on instruction sets and firmware development. These files may be found on the Microchip web site or from your local sales office.

MPLAB® XC16 C Compiler User's Guide (DS52071)

This document helps you use Microchip's MPLAB XC16 C compiler to develop your application. MPLAB XC16 is a GNU-based language tool, based on source code from the Free Software Foundation (FSF). For more information about FSF, see www.fsf.org.

MPLAB® X IDE User's Guide (DS52027)

This document describes how to use the MPLAB X IDE, Microchip's latest version of its integrated development environment, as well as the MPLAB Project Manager, MPLAB Editor and MPLAB SIM Simulator. Use these development tools to help you develop and debug application code.

THE MICROCHIP WEB SITE

Microchip provides online support via our web site at www.microchip.com. This web site is used as a means to make files and information easily available to customers. Accessible by using your favorite Internet browser, the web site contains the following information:

- **Product Support** – Data sheets and errata, application notes and sample programs, design resources, user's guides and hardware support documents, latest software releases and archived software
- **General Technical Support** – Frequently Asked Questions (FAQs), technical support requests, online discussion groups, Microchip consultant program member listing
- **Business of Microchip** – Product selector and ordering guides, latest Microchip press releases, listing of seminars and events, listings of Microchip sales offices, distributors and factory representatives

DEVELOPMENT SYSTEMS CUSTOMER CHANGE NOTIFICATION SERVICE

Microchip's customer change notification service helps keep customers current on Microchip products. Subscribers will receive e-mail notification whenever there are changes, updates, revisions or errata related to a specified product family, or development tool of interest.

To register, access the Microchip web site at www.microchip.com, click on Customer Change Notification and follow the registration instructions.

The Development Systems product group categories are:

- **Compilers** – The latest information on Microchip C compilers, assemblers, linkers and other language tools. These include all MPLAB C compilers; all MPLAB assemblers (including MPASM™ Assembler); all MPLAB linkers (including MPLINK™ Object Linker); and all MPLAB librarians (including MPLIB™ Object Librarian).
- **Emulators** – The latest information on Microchip in-circuit emulators. This includes the MPLAB REAL ICE™ and MPLAB ICE 2000 in-circuit emulators.
- **In-Circuit Debuggers** – The latest information on the Microchip in-circuit debuggers. This includes MPLAB ICD 3 in-circuit debuggers and PICKit™ 3 debug express.
- **MPLAB® IDE** – The latest information on Microchip MPLAB IDE, the Windows® Integrated Development Environment for development systems tools. This list is focused on the MPLAB IDE, MPLAB IDE Project Manager, MPLAB Editor and MPLAB SIM Simulator, as well as general editing and debugging features.
- **Programmers** – The latest information on Microchip programmers. These include production programmers, such as MPLAB REAL ICE™ in-circuit emulator, MPLAB ICD 3 in-circuit debugger and MPLAB PM3 device programmers. Also included are non-production development programmers, such as PICSTART® Plus and PICKit 2 and 3.

CUSTOMER SUPPORT

Users of Microchip products can receive assistance through several channels:

- Distributor or Representative
- Local Sales Office
- Field Application Engineer (FAE)
- Technical Support

Customers should contact their distributor, representative or Field Application Engineer (FAE) for support. Local sales offices are also available to help customers. A listing of sales offices and locations is included in the back of this document.

Technical support is available through the web site at:

<http://www.microchip.com/support>

REVISION HISTORY

Revision A (June 2013)

This is the initial release of this document.

Chapter 1. Introduction to the Starter Kit

Thank you for purchasing the MPLAB Starter Kit for Intelligent.Integrated.Analog. This board is intended to introduce the PIC24FJ128GC010 family of advanced analog microcontrollers and demonstrate its wide range of on-chip analog features.

This chapter introduces the Starter Kit and provides an overview of its features. Topics covered include:

- [Overview](#)
- [What's in the Kit](#)
- [Hardware](#)
- [Installing Device Drivers for the Starter Kit](#)

1.1 OVERVIEW

The Starter Kit board includes many analog features to showcase the capabilities of the PIC24FJ128GC010 family. The included 100-pin microcontroller integrates the following analog features:

- A high-speed (10 Msps), 12-bit A/D Converter with multiple input channels
- A high-accuracy, 16-bit Sigma-Delta A/D Converter with two input channels
- Dual 10-bit, voltage output Digital-to-Analog Converters (DACs)
- Two op amps and three comparators
- mTouch™ capacitive sensing

In addition, the Starter Kit board adds external analog and digital sensors, including:

- Ambient light sensor
- Digital temperature sensor
- Microphone
- Headphone/line amplifier (stereo)
- Precision, low-drift voltage reference
- Optional expansion area for a Microchip wireless radio module (MRF24J40A)
- Optional NTC thermistor

The board comes preprogrammed with a menu driven demonstration application that highlights most of the functions on the board. The application can be overwritten with your own software, using the PICkit On Board (PKOB) programmer; no external programmer is needed.

The preprogrammed application operates on a stand-alone basis; other than power from a USB connection, no computer or client-side software is required for the board to operate.

The low operating current (7 mA) of the PIC24FJ128GC010 microcontroller means the entire board can be powered from a USB connection or optionally, by battery. The entire Starter Kit itself draws approximately 25 mA from the USB host when running the demo application; the actual current varies slightly between different segments of the application. In Reduced Power mode, the total current draw for the Starter Kit is 1.7 mA, the majority of which is drawn by the LEDs, with about 150 µA for the microcontroller.

1.2 WHAT'S IN THE KIT

Your MPLAB Starter Kit for Intelligent.Integrated.Analog should contain the following:

- MPLAB Starter Kit board
- USB cable (A to mini-B)
- An insert card with links to the web site for this manual and the demo application

1.3 HARDWARE

Figure 1-1 identifies the major features of the Starter Kit.

FIGURE 1-1: STARTER KIT BOARD, FRONT AND BACK VIEWS

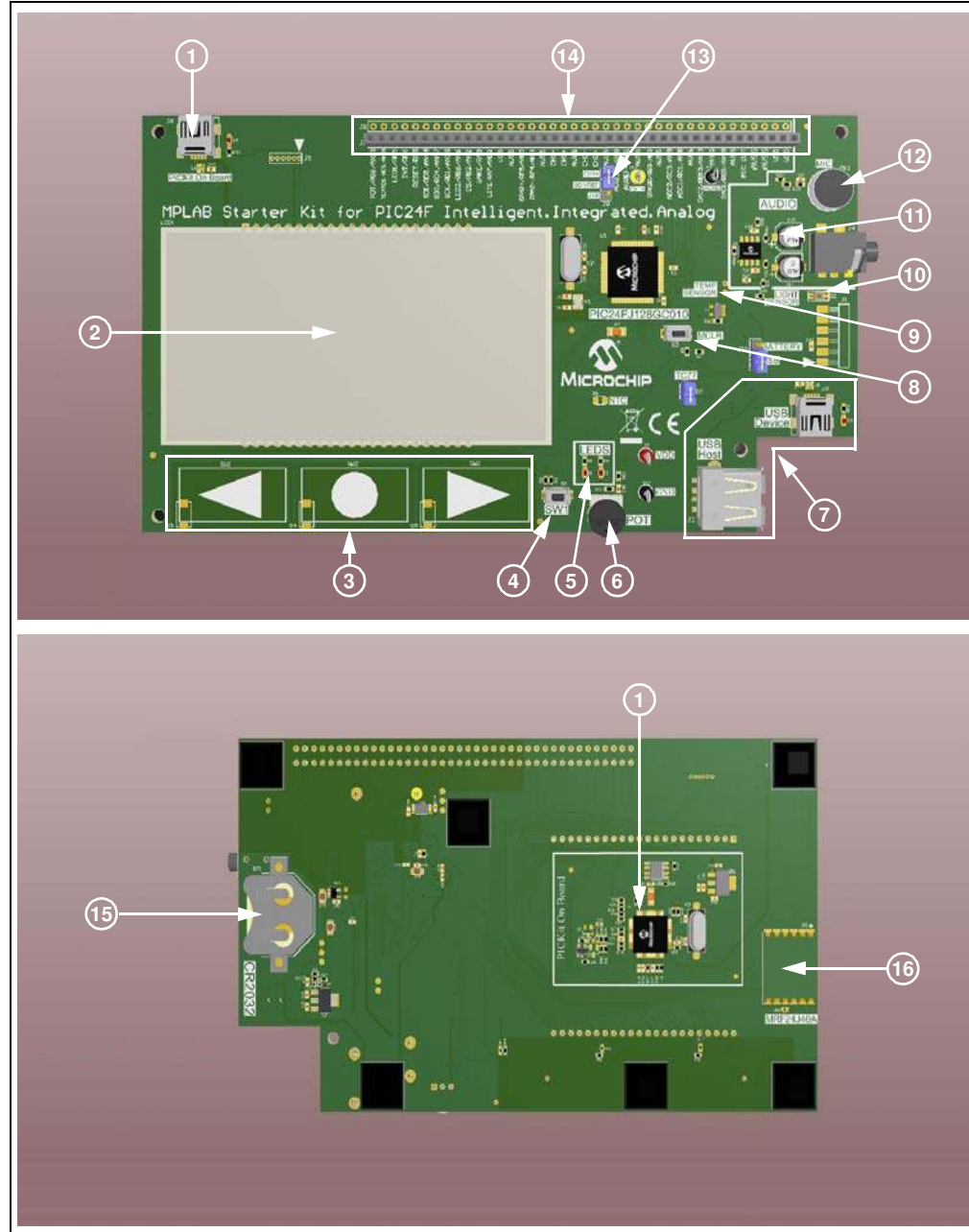

1. PICKit On Board (PKOB) USB Programmer/Debugger and Connector

The PKOB is used to program the PIC24FJ128GC010 MCU on the Starter Kit. It connects via USB to MPLAB X, Microchip's programming and debugging environment, and eliminates the need for an external hardware programmer. For more information on loading your own application into the Starter Kit (or reloading the original application), see [Section 3.1 "Reprogramming the Starter Kit Using the PKOB"](#).

2. LCD Display

This is a custom passive display panel developed exclusively for Microchip Technology. The panel is an STN, positive-sense LCD, organized as a 36-segment by 8-column display. It includes a 37 x 8 dot-matrix array for alphanumeric or special characters and 17 special purpose display icons (useful for many consumer applications) composed of 29 addressable elements.

The LCD panel is directly driven from the I/O pins of the PIC24FJ128GC010 microcontroller; a separate display controller is not required. Multiplexing of the display elements is described in [Appendix B. "LCD Panel Information"](#).

3. mTouch Navigation Touch Pads

These three navigation buttons are designed into the PCB itself and are configured to respond to the user's body capacitance when touched. Control of the touch sense features are built on the PIC24F microcontroller's on-chip Charge Time Measurement Unit (CTMU) module, which uses a constant-current source to detect changes in the pad's capacitance. A more detailed description of the CTMU module's operation is provided in the *"PIC24F Family Reference Manual"*, ["Charge Time Measurement Unit \(CTMU\)"](#) (DS39724). Additional information on the mTouch system is available at www.microchip.com/mtouch.

The buttons are covered in detail in [Section 2.1 "Start-up Display"](#).

4. SW1 Momentary Push Button

This is normally an open SPST push button connected to port pin, RD0. Pressing this button brings RD0 to logic low (ground). The demo application uses this switch to toggle Sleep mode, as described in [Section 2.2.9 "Entering Reduced Power \(Sleep\) Mode"](#).

5. User LEDs

These two red LEDs are tied to port pins. D1 is tied to RE7 and D2 is tied to RB6. A logical '1' on the port pin will light the corresponding LED. When on, each draws 1 mA of current.

6. Potentiometer (R7)

This 10 k Ω trim potentiometer is connected to the analog input pin, AN19. It is configured as a voltage divider between SWITCHED_VDD and ground. See [Section 1.3.1.1 "SWITCHED_VDD Control"](#) for more information.

7. USB Host and Device Connectors (J2 and J3)

Connectors, J2 (USB-A) and J3 (USB mini-B), allow the Starter Kit board to provide USB host and device functionality. These two USB connectors share the microcontroller's single USB port; therefore, only one device can be connected at a time. The preprogrammed application is configured for device functionality only.

When the board is connected through J2, VBUS is used to power the PIC24FJ128GC010 microcontroller (both VDD and SWITCHED_VDD). LED D4 lights when VBUS is detected. The PKOB is not powered.

8. MCLR Push Button (S2)

Pressing the switch pulls the $\overline{\text{MCLR}}$ pin low, causing a Reset for the microcontroller and any application that may be running.

9. Digital Temperature Sensor (U9) and Jumper, JP7

The TC77 is a digital temperature sensor in a SOT-23 package. It uses an SPI interface to communicate to the microcontroller. The TC77 is powered as part of the SWITCHED_VDD bus.

When installed (default), jumper, JP7, connects the TC77 chip select to port pin, RE9. If the TC77 is not needed, removing JP7 allows port pin, RE9, to be used as a general purpose I/O resource.

10. Indoor Ambient Light Sensor (Q1)

Q1 is a phototransistor, used to detect indoor ambient light level. The sensor is designed to output a current in the range of 5 μ A to 300 μ A, as the light flux varies from 10 to 1000 lux. This current flows through R11, causing a voltage of $V_{DD} - (I_{SENSOR}/R11)$ to be applied to analog input pin, AN22. The resulting DC voltage is inversely proportional to the amount of light on the sensor, ranging from 3.3V (dark) to 50 mV (very bright).

The value of R11 (27 k Ω) limits the upper light level to approximately 400 lux. (As a reference, the average ambient light in an office is 300 to 400 lux.)

11. Audio Output Driver and Output Jack (3.5 mm)

The microcontroller's two 10-bit DACs are connected via buffer op amp, U3 (MCP6022), to this jack. DAC1 (port pin, RG9) is connect to the right channel and DAC2 (port pin, RB13) is connected to the left channel. The op amp is configured as a unity gain buffer. The op amp buffer is powered from the SWITCHED_VDD bus.

A simple RC filter with a cut point of -3 dB point at 16 kHz is in series with each output. When connecting to a high-impedance input (such as external powered speakers), the 15 Ω series resistor has little effect on the amplitude.

Note: Each DAC is capable of driving full-scale levels (i.e., 3.3V p-p). The 15 Ω limiting resistor, in series with the outputs, should limit the output to a standard 16 Ω headset to approximately 1.5V maximum. However, this level may exceed safe listening levels. When driving headphones, it is recommended that the output level be kept under 200 mV p-p.

12. Electret Microphone

This is a simple, unamplified microphone, which is biased at 1/2 of the SWITCHED_VDD voltage (about 1.65V). The output is AC-coupled and brought out to Pin 5 of J7/J8. For voice use, the output will need to be boosted to approximately 20X.

13. Precision Voltage Reference Section Jumper (J9)

The jumper selects the on-board, precision 2.5V voltage reference or an externally applied reference on the CH1+ (default) connection on J7/J8 for use with the Sigma-Delta A/D Converter. The default configuration is VDD as the reference, which is also the default configuration for the preprogrammed demonstration.

For low noise and more accurate measurements, the 2.5V precision reference is required. Since the input range of the A/D is VSS to VREF, using the 2.5V reference reduces the converter's input range.

14. Breakout Connectors (J7/J8)

Connectors, J7 and J8, provide a direct interface to select functions of the PIC24FJ128GC010 microcontroller. Connector, J7, is a standard riser and can accept standard 0.025" square posts. J8 is a parallel connected set of through holes. The mapping of microcontroller pins to riser pins is listed in [Table 1-1](#).

Many of the microcontroller pins are multiplexed with several functions. Refer to [Appendix A. "Starter Kit Schematics"](#) and the PIC24FJ128GC010 device data sheet if you wish to remap the pins for a custom application.

TABLE 1-1: MAPPING OF BREAKOUT CONNECTOR PINS TO MICROCONTROLLER FUNCTIONS

J7/J8 Pin	Function	Device Pin	J7/J8 Pin	Function	Device Pin
1	VDD	—	21	GND	—
2	VDD	—	22	CH1+ IN	35
3	GND	—	23	CH1- IN	36
4	GND	—	24	GND	—
5	MIC OUT	—	25	OPA2- IN	49
6	GND	—	26	OPA2+ IN	50
7	DAC1 OUT	14	27	GND	—
8	GND	—	28	GND	—
9	DAC2 OUT	42	29	LIGHT OUT	92
10	GND	—	30	WAKE	28
11	1 IN	6	31	$\overline{\text{CS}}$ RF	11
12	2 IN	8	32	LED2	26
13	GND	—	33	SCK	76
14	OPA2 OUT	22	34	SDO	81
15	GND	—	35	SDI	82
16	AVREF- IN	24	36	WAKE	28
17	AVREF+ IN	25	37	INT IN	4
18	GND	—	39	LED1	5
19	CH0+ IN	33	39	TC77 CS	19
20	CH0- IN	34	40	POT OUT	12

15. C2032 Battery Holder (BT1)

This allows the Starter Kit (i.e., those portions driven from the PIC24FJ128GC010 microcontroller) to be powered from a single coin cell, as opposed to USB power. Jumper, J10, must also be configured to use the battery power feature.

16. RF Transceiver Footprint (U2)

This 14-pin area is designed to accept an optional Microchip MRF42J40A wireless transceiver, for use with wireless application development. Note that the transceiver requires permanent surface mounting to this area. The preprogrammed demonstration does not support the use of the wireless transceiver.

1.3.1 Power Sources

The Starter Kit can be powered in one of three ways, depending on the usage:

- PKOB USB Connector (J6). This will power the entire MPLAB Starter Kit board, including the PICkit programming circuitry. Jumper, J10, must be placed into the USB position (Pins 2-3), which is the default position. Both power LEDs (D4 and D5) will light.
- USB Device Port (J3). In this mode, only those portions of the board driven by the PIC24FJ128GC010 are functional; the PKOB is not powered. Jumper, J10, must be placed into the USB position (Pins 2-3), which is the default position. Only LED, D4, will light.
- CR2032 Coin Cell (not supplied). Only those portions of the board driven by the PIC24FJ128GC010 microcontroller are functional; the PKOB is not powered. Jumper, J10, must be placed into the BATTERY position (Pins 1-2). While operating from a battery, the USB LEDs do not light.

1.3.1.1 SWITCHED_VDD CONTROL

In order to reduce power consumption of the Starter Kit, certain circuits can be powered on or off by the microcontroller. This is controlled by port pin, RA9 (WAKE). Asserting this pin (logic '1') turns VDD on to the following devices:

- MCP6022 headphone buffer (U3)
- Potentiometer (R7)
- TC77 temperature sensor (U8)
- Ambient light sensor (Q1)
- Precision voltage reference (U11)
- Electret Microphone (MK1)
- Optional wireless module (U2) (also is the WAKE function to the module)

When `SWITCHED_VDD` is off, power supply current is reduced approximately 3.5 mA without the wireless module installed. Since the wireless module shares its WAKE pin with the control line for `SWITCHED_VDD`, the module will not be able to go into Sleep mode. Installing the wireless module adds approximately 21 mA of current requirement whenever `SWITCHED_VDD` is asserted.

1.4 INSTALLING DEVICE DRIVERS FOR THE STARTER KIT

The USB mode firmware requires the generic Microsoft[®] WinUSB driver (`winusb.dll`) to be in the directory, `C:\windows\system32`. This driver should already be installed on computers running Microsoft Windows. When the Starter Kit board is attached for the first time, a notification window that drivers are being installed may briefly appear.

When the drivers are properly installed, the Starter Kit will appear as a USB COM port when plugged into the USB device port (J3).

Chapter 2. The Demonstration Application

This chapter describes the preprogrammed demonstration on the Starter Kit. The application is essentially free-standing and does not require a host application running on a computer. The board can be powered from either USB mini-B connector (J3 or J6).

2.1 START-UP DISPLAY

The application displays a 24-hour clock (**hh:mm**, with flashing colon). The Microchip logo icon appears in the lower right corner of the LCD; LED, D4, is also lit. If this is not correct, try unplugging and replugging the USB cable. Refer to [Chapter 4. “Troubleshooting”](#) for more information.

The three mTouch touch pads are used by the demo code for data entry and navigation:

- Left Arrow (◀): Decrement current display value or go to the previous demo
- Circle (●): Enter data or select the next submenu
- Right Arrow (▶): Increase current display value or go to the next demo

The mTouch software included in the application waits a preset time to verify the pad has been touched. When the software decodes a “finger down” event, the red LED, D1, will light. When the finger is lifted off the pad, the LED is turned off and the demo application executes the action. Tapping the pad for less than the programmed time (about 100 ms) will not cause a press to be detected.

2.2 SECTIONS OF THE DEMO

The demo application is divided into several foreground sections, with each dedicated to showing a unique function of the microcontroller. In addition to these, the demo application runs a continuous background process to export data over the USB port.

The sections are organized as a closed-loop menu, meaning they will repeat once the end is reached if the ▶ key is pressed. The sections are ordered as follows:

- Clock
- Sigma-Delta A/D
- Pipelined A/D (also includes the ambient light sensor)
- Stereo DAC
- Temperature Sensor (external TC77 sensor)
- LCD Test
- Audio Input (microphone)

Some sections (like setting the clock) have submenus, which are selected using the ● pad. Detailed information on each section follows.

2.2.1 Clock Demo

The 24-hour clock is the home page for the demo. This is a 24-hour clock with a blinking colon for seconds. The clock uses the on-board 32 kHz Secondary Oscillator (SOSC) for an accurate time base.

To set the clock to the proper time:

1. Press ● when the LCD is displaying the clock.
2. The display shows, **hh:mm**, where '**hh**' is the current hour and '**mm**' is the current minute. The first hours digit begins to blink, indicating that is the current digit to set.
3. Press the ◀ pad to decrement the hours digit or press ▶ to increment the digit. Since this is a 24-hour setting, the digits cycle through 0 > 1 > 2 > 0... .
4. When the correct digit is shown, press ● to save it. The current digit stops blinking and the next digit begins to blink.
5. Repeat Steps 2 through 4 for each of the remaining digits until the display is showing the correct time.

Note that there is no back key to return to a previous digit. If you make an error after pressing the ● key, you have to start over.

2.2.2 Sigma-Delta A/D Demo

This section demonstrates the Sigma-Delta A/D Converter. For more information on this module and its feature set, refer to the *"PIC24F Family Reference Manual"*, **"16-Bit Sigma-Delta A/D Converter"** (DS30687).

Pressing the ▶ pad from the clock demo causes the LCD to momentarily display, **"SD ADC CH:DATA"**. **"CH:DATA"** is the display format of the A/D result, where **"CH"** is the Sigma-Delta A/D channel and **"DATA"** is a 16-bit signed hexadecimal value. Positive values are in the range of 0000h to 7FFFh. Due to a slight offset voltage, the display may indicate a small negative voltage (FFC0h to FFFFh). If the CH+/CH- inputs are swapped, the display will show negative values (a range of 8000h to 0000h).

The demo uses CH1 to read an externally applied voltage with SVDD (3.3V) as the A/D voltage reference. The precision 2.5V reference can be used if the demo application is modified (or replaced with custom code) to use CH1+ as the reference and measurements are taken with the CH0 channel.

The input amplifier for the Sigma-Delta A/D is differential; that is, you can apply a differential voltage across the two inputs. This is why swapping the inputs in the demo generates a negative value. The amplifier has different gain settings but in the demo, it is set for a gain of 1.

It is also possible to make a single-ended measurement with the Sigma-Delta A/D Converter by applying a voltage to one terminal, while the other is the ground reference. To do this, with using SVDD as a reference:

1. Set jumper, J9, to the CH1+ position.
2. Connect an external jumper wire between CH1- (J7, Pin 23) and AVSS (any of the GND pins on J7).
3. Connect the voltage to be measured to CH1+ (J7, Pin 22). The voltage must be in the range of 0V to 3.3V.

The Demonstration Application

2.2.3 Pipeline A/D Demo

This section of the demo uses the 12-bit Pipeline A/D Converter. For more information on this module and its operation, refer to the “PIC24F Family Reference Manual”, “12-Bit, High-Speed Pipeline A/D Converter” (DS30686).

The Pipeline A/D demo uses two analog input channels of the Pipeline A/D Converter to display a pair of bar graphs. The bar graphs extend, left-to-right, across the LCD. The top bar is the reading of the potentiometer, R7 (AN19), and the lower bar graph is the ambient light sensor, Q1 (AN22). Turning the thumb wheel counterclockwise, or covering the light sensor, reduces the corresponding bar.

While in this demo, pressing the ● pad advances through a sequence of display options. On the first touch, the display shows, “19 : xxxx”, where “xxxx” is the hexadecimal value from the A/D of the potentiometer’s current setting (range, 0 to 0FFFh).

Pressing ● again displays, “22 : yyyy”, where “yyyy” is the hexadecimal value from the A/D of the light sensor; the value increases with less light.

Pressing ● again displays, “8 : zzzz”, to display the converted value on AN8 (Pin 11 on JP7/8), where “zzzz” is the hexadecimal value of the voltage. If a voltage is not present, and AN8 is not tied to Vss, this value will be random.

Pressing ● once more returns to the original display.

The data from the potentiometer, light sensor and AN8 are output over the USB port, as described in [Section 2.2.8 “Background Data Transmission”](#), via the background data transmission process.

2.2.4 Stereo DAC Demo

This section generates three audio sine waves, one octave apart. The demo application calculates a 512-point sine wave and stores the 10-bit values for each point in RAM. Timer4 is used to transfer (via the DMA bus) the RAM buffer to the DAC Output registers. The output frequency is calculated, on-the-fly, as a passed parameter in Hz. The frequencies of the three tones generated are: 110 Hz, 220 Hz and 440 Hz (A₂, A₃ and A₄ or middle A).

The raw DAC output is passed through the 16 kHz low-pass filters and to the headphone jack. The maximum voltage generated by the demo is 800 mV p-p.

Pressing the ● key steps through the three different frequencies.

Note: Do not use excessive volume with this part of the demo. The maximum output (800 mV p-p) may produce an audio output in excess of safe listening levels.
--

2.2.5 TC77 Temperature Sensor Demo

This section uses the TC77 temperature sensor (U8) to obtain the ambient temperature. This sensor transfers data to the microcontroller via the SPI bus. The chip select is provided by the port pin, RE9, and is routed via jumper, JP7.

By default, the demo displays the board’s current temperature in degrees Centigrade. Pressing ● converts the reading to Fahrenheit. The LCD displays the thermometer icon and the appropriate temperature unit icon.

2.2.6 LCD Test Demo

This section of the demo displays all the available graphic icons and sequentially flashes each one while showing their name in the dot-matrix portion of the LCD. This demo repeats continuously until another portion is selected. There is no submenu.

2.2.7 Audio/Microphone Demo

This section uses a bar graph display to represent the output of the unamplified electret microphone. The 12-bit Pipeline A/D Converter is used to measure the amplitude of the output signal.

To use this section, it is necessary to first connect MIC OUT (J7/J8, Pin 5) to ADC1 IN (Pin 11) with a jumper wire (22 gauge recommended). The display bar graph increases (extends to the right) as the amplitude of the input signal increases. As the microphone's output is low, it is necessary to directly tap on it or blow into it to get a response.

The on-board electret microphone is biased at 1.6 VDC and is unamplified. To use the microphone for voice recording, it will be necessary to add an amplifier. An appropriate design would be an AC-coupled amplifier, with approximately 20X gain, and with an output DC-biased to 1.6V (the microphone's normal bias level) at midscale. An example of a suitable design is provided in [Appendix C. "Optional Microphone Amplifier"](#).

2.2.8 Background Data Transmission

As the foreground demo application runs, a separate background process is also executing. This process sequentially converts the input from three different analog inputs into a digital value and exports this data over USB as a virtual COM (serial) port. The Pipeline A/D demo must be selected for data to be output on the USB port. The data is output in three hexadecimal words, representing the potentiometer value, the light sensor value and the signal on AN8. The process repeats the conversions and exports the most current values continuously.

The data from this process can be read from the virtual COM port by using any available serial terminal emulator.

2.2.9 Entering Reduced Power (Sleep) Mode

During any foreground section of the application, pressing SW1 places the microcontroller in Sleep mode. While in this mode, execution of the demo is paused while the display returns to the 24-hour clock demo. Also, two "z"s are added to the LCD display. The background transmission of data over the virtual COM port also pauses. The microcontroller wakes, once every minute, allowing the time display to be updated, after which the microcontroller returns to Sleep mode.

Pressing SW1 again ends Sleep Mode. The "z"s on the display are removed and the clock display's colon resumes blinking.

2.3 OTHER HARDWARE RESOURCES ON THE STARTER KIT

Connector, J2, is configured as a USB host. As it is connected in parallel with the USB device port connector, J2 cannot be used while J3 is in use.

A footprint (R5) is provided on the board for an add-on thermistor. The footprint is designed to accommodate an NTC thermistor in an 0805 package size. Typical values are 10 k Ω and 47 k Ω . The CTMU can source a current to the NTC and read the resulting voltage using the 12-bit Pipeline A/D Converter. This feature is not implemented in the supplied demo software. For more information, refer to Microchip Application Note, AN1375, "See What You Can Do with the CTMU" (DS01375).

If touch sensing is not desired, the function of the touch pads can be replaced with push button (or other momentary contact) switches. Spaces are provided for switches, S3, S4 and S5, as well as corresponding (unpopulated) pull-up resistors, R12, R52 and R54. Note that installing these components does not automatically disable touch sense functionality.

The footprint for U2 has been designed to directly solder mount one of Microchip Technology's wireless transceiver modules. Although the MRF24J40A (2.4 GHz, IEEE 802.15.4) wireless transceiver is specified elsewhere in this manual, in theory, any pin-compatible Microchip wireless transceiver module can be used.

The unpopulated footprints for J1 and J5 are provided in the event that additional programming and emulation interfaces are required. J1 provides a 6-pin interface to the Starter Kit for use as a ICSP™ compatible emulator product (Microchip MPLAB ICD 3 programmer, the PICkit 3 programmer or the MPLAB REAL ICE emulator). It can also be used as an alternative method for directly programming the PIC2FJ128GC010 microcontroller via In-Circuit Serial Programming™ (ICSP™). J5 provides a standard 5/6-pin interface to the PKOB and can be used to update its firmware.

NOTES:

Chapter 3. Developing New Applications

The MPLAB Starter Kit for Intelligent.Integrated.Analog may be used with MPLAB® IDE, the free Integrated Development Environment available on Microchip's web site. MPLAB IDE allows the starter kit to be used as an in-circuit debugger as well as a programmer for the featured device.

In-circuit debugging allows you to run, examine and modify your program for the device embedded in the Starter Kit hardware. This greatly assists you in debugging your firmware and hardware together.

Working through the PICKit On Board (PKOB), the Starter Kit interacts with the MPLAB IDE application to run, stop and single-step through programs. Breakpoints can be set and the processor can be reset. Once the processor is stopped, the register's contents can be examined and modified.

3.1 REPROGRAMMING THE STARTER KIT USING THE PKOB

When the Starter Kit is connected from your computer to the PICKit On Board USB connector (J6), MPLAB recognizes it as a valid programmer and debugger. In MPLAB IDE 8.x, the drop-down menu will show "Starter Kit on Board" as the correct name ([Figure 3-1](#)).

FIGURE 3-1: SELECTING THE PKOB IN EARLIER VERSIONS OF MPLAB® IDE

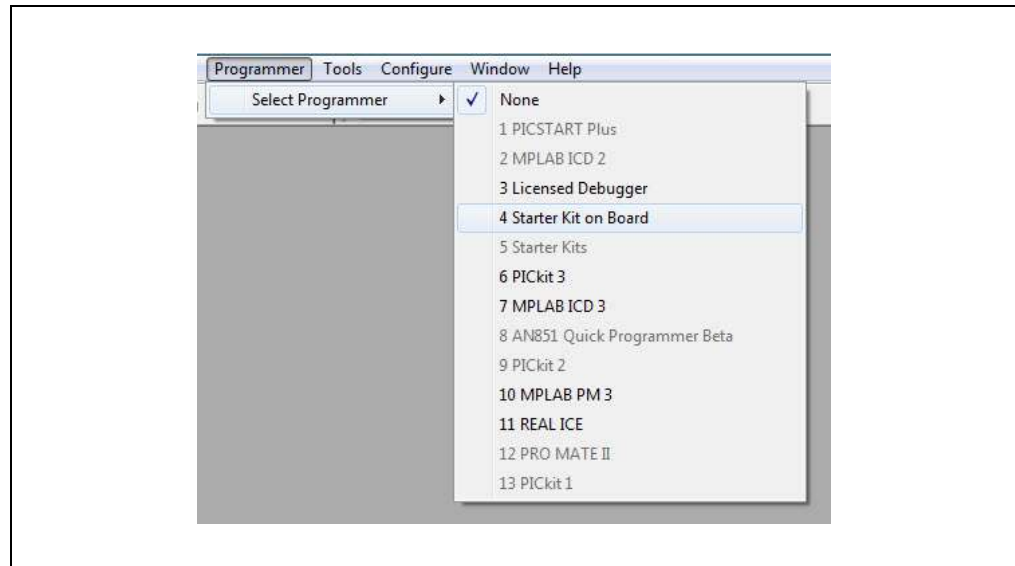

MPLAB X refers to it as “Starter Kits (PKOB)”; see [Figure 3-2](#). In the MPLAB X example, the Serial Number (SN) of the board will differ from the one shown.

In all cases, be sure to select PIC24FJ128GC010 as the device name in the Project window.

FIGURE 3-2: SELECTING THE PKOB

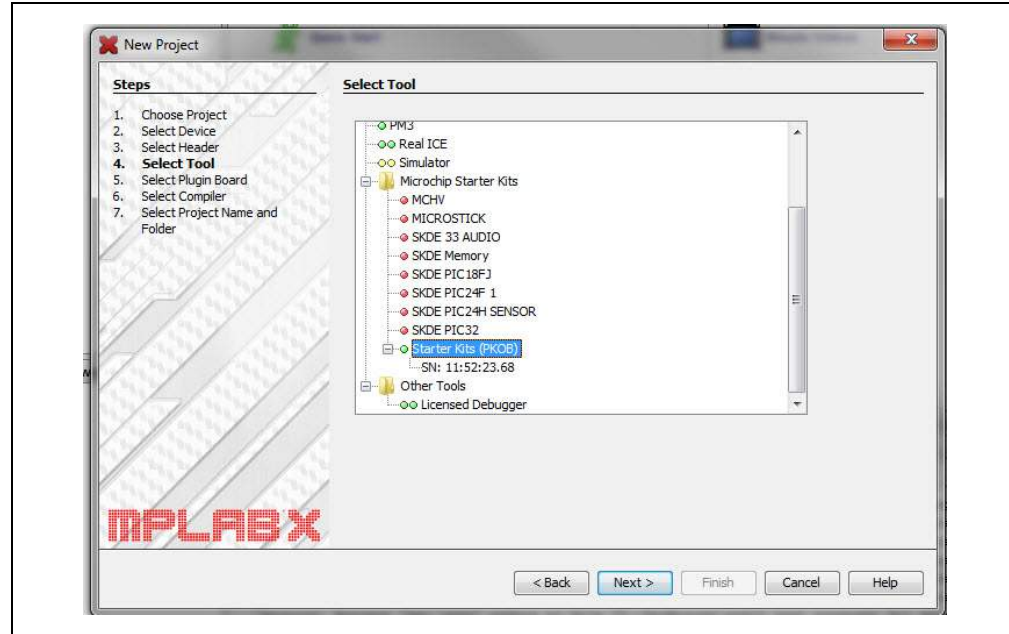

The application originally included with the Starter Kit is not protected; you may overwrite it with your own code. If you wish to reload the demo software, the files can be found on the Microchip web site (www.microchip.com/PIC24FJ128GC010).

3.2 HARDWARE CONSIDERATIONS FOR NEW APPLICATIONS

When developing your own application for the Starter Kit board, it is important to set each pin on the microcontroller's I/O ports to the proper type (analog or digital) and to the proper state (input or output).

Certain I/O pins on the PIC24FJ128GC010 microcontroller (and the corresponding pin on J7/J8) can be used as general purpose I/Os. Others are hard-wired to Starter Kit circuitry, but may be available under certain conditions. [Table 3-1](#) lists these pins.

TABLE 3-1: I/O PINS AVAILABLE FOR USER

PIC24FJ128GC010 Pin	J7/J8 Pin	Function	Comment
RE6/PMD6/CN64	37	External Interrupt from Wireless Module	Available if there is no wireless module
RE9/AN21/CN67	39	Chip Select for TC77	Available if JP7 shunt is removed
RF4/AN11/OPA2N3/CN17	25	OPA2- (input)	Free to use
RF5/AN10/OPA2P2/CN18	26	OPA2+ (output)	Free to use
RG7/AN18/CN9	31	Chip Select (low) for Wireless Module	Available if there is no wireless module
AN9/RPI40/CN47/RC3	12	ADC2 Input	Free to use
AN8/RPI38/CN45/RC1	11	ADC1 Input	Free to use
AN3/OPA2O/CN5/RB3	14	OPA2O (output)	Free to use

Note: Op amp OPA1 cannot be used on the Starter Kit as its output pin is used for the PKOB.

If the LCD display is not being used in the new application, the pins driving the panel segment and columns must be set as digital inputs; this prevents possible damage to the LCD. This includes the following pins:

- RA<15:14>,<10>,<6:0>
- RB<15:14>,<12:7>
- RC2
- RD<15:13>,<11:6>
- RE<8>,<4:0>
- RF<13:12>,<8>,<3:0>
- RG<15:12>,<1:0>

If the potentiometer, R7 (AN19/RG8), or the phototransistor sensor, Q1 (AN22/RA7), is not to be used, the associated pin(s) must remain set as an analog input.

The digital input for SW1 (RD0) must remain set as a digital input.

NOTES:



Chapter 4. Troubleshooting

This chapter discusses common operational issues and how to resolve them.

1. The demo application does not run.

The Starter Kit board must be plugged into a powered USB hub, computer or other USB host device. Start by plugging into the USB device port, J2. LED, D4, should light when VBUS is detected.

If D4 is not lit, verify that the USB host side port is functional.

Verify that there is a jumper in the USB position on J10.

2. The temperature sensor does not provide a reading or does not read correctly.

Verify that a jumper is installed at JP7.

3. The Starter Kit is not recognized as a COM port device when it is connected.

The virtual COM port is only available when the Starter Kit is connected through the device port (J2).

Be certain to launch the terminal software only after the Starter Kit has been powered up and the demo application is running. If the terminal program is started first, it will not see the Starter Kit.

4. The light sensor's voltage saturates under some bright light conditions.

The voltage generated by Q1 is set by resistor, R11. The default value is 27 kΩ. If your ambient light is bright (over 500 lux), try lowering the value of R11 to 15 kΩ.

NOTES:



Appendix A. Starter Kit Schematics

The following schematic diagrams are included in this appendix:

Application:

- [Figure A-1](#): Application Microcontroller and Associated Components
- [Figure A-2](#): LED Display and other Application Components

Programmer/Debugger:

- [Figure A-3](#): PICkit On Board Programmer/Debugger

Appendix B. LCD Panel Information

This section provides specific pinout and multiplexing information for the Microchip custom LCD display panel. It is furnished for those users who desire to design custom applications using the MPLAB Starter Kit for Intelligent.Integrated.Analog display.

The layout of the display elements is shown in [Figure B-1](#). The letters and numbers in grey (white on some graphic elements) indicate the pixel address in the dot-matrix section, or the graphic element in the icon section, and are not part of the actual display.

[Table B-1](#) shows the mapping of the panel's pins to display segments and commons. [Table B-2](#) shows the segment column mapping for each display element.

FIGURE B-1: MICROCHIP CUSTOM LCD PANEL (ELEMENT NUMBERS SHOWN IN GREY)

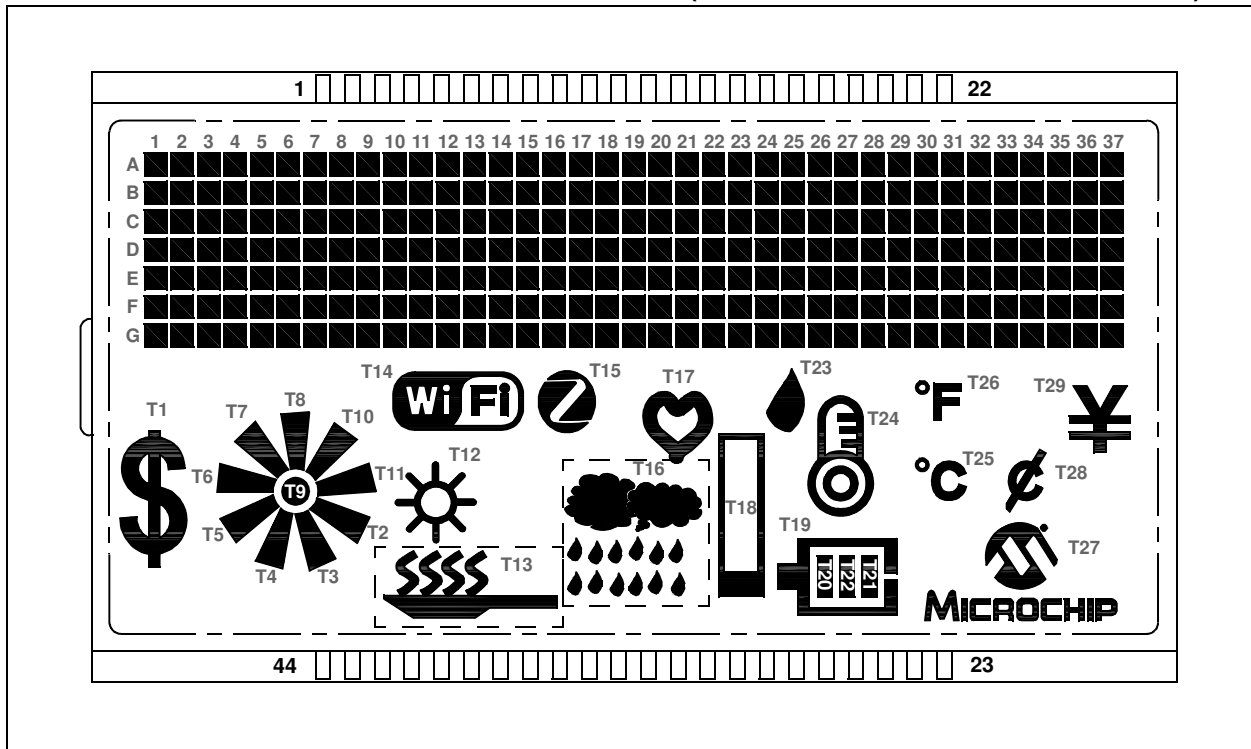

TABLE B-1: LCD PANEL PIN MAPPING

Pin #	Function	Pin #	Function
1	SEG1	23	SEG23
2	SEG2	24	SEG24
3	SEG3	25	SEG25
4	SEG4	26	SEG26
5	SEG5	27	SEG27
6	SEG6	28	SEG28
7	SEG7	29	SEG29
8	SEG8	30	SEG30
9	SEG9	31	SEG31
10	SEG10	32	SEG32
11	SEG11	33	SEG33
12	SEG12	34	SEG34
13	SEG13	35	SEG35
14	SEG14	36	SEG36
15	SEG15	37	COL8
16	SEG16	38	COL7
17	SEG17	39	COL6
18	SEG18	40	COL5
19	SEG19	41	COL4
20	SEG20	42	COL3
21	SEG21	43	COL2
22	SEG22	44	COL1

LCD Panel Information

TABLE B-2: LCD PANEL DISPLAY ELEMENT MAPPING

	COL1	COL2	COL3	COL4	COL5	COL6	COL7	COL8
SEG1	D1A	D1B	D1C	D1D	D1E	D1F	D1G	T1
SEG2	D2A	D2B	D2C	D2D	D2E	D2F	D2G	T2
SEG3	D3A	D3B	D3C	D3D	D3E	D3F	D3G	T3
SEG4	D4A	D4B	D4C	D4D	D4E	D4F	D4G	T4
SEG5	D5A	D5B	D5C	D5D	D5E	D5F	D5G	T5
SEG6	D6A	D6B	D6C	D6D	D6E	D6F	D6G	T6
SEG7	D7A	D7B	D7C	D7D	D7E	D7F	D7G	T7
SEG8	D8A	D8B	D8C	D8D	D8E	D8F	D8G	T8
SEG9	D9A	D9B	D9C	D9D	D9E	D9F	D9G	T9
SEG10	D10A	D10B	D10C	D10D	D10E	D10F	D10G	T10
SEG11	D11A	D11B	D11C	D11D	D11E	D11F	D11G	T11
SEG12	D12A	D12B	D12C	D12D	D12E	D12F	D2G	T12
SEG13	D20A	D20B	D20C	D20D	D20E	D20F	D20G	T20
SEG14	D21A	D21B	D21C	D21D	D21E	D21F	D21G	T21
SEG15	D22A	D22B	D22C	D22D	D22E	D22F	D22G	T22
SEG16	D30A	D30B	D30C	D30D	D30E	D30F	D30G	D37A
SEG17	D31A	D31B	D31C	D31D	D31E	D31F	D31G	D37B
SEG18	D32A	D32B	D32C	D32D	D32E	D32F	D32G	D37C
SEG19	D33A	D33B	D33C	D33D	D33E	D33F	D33G	D37D
SEG20	D34A	D34B	D34C	D34D	D34E	D34F	D34G	D37E
SEG21	D35A	D35B	D35C	D35D	D35E	D35F	D35G	D37F
SEG22	D36A	D36B	D36C	D36D	D36E	D36F	D36G	D37G
SEG23	D29A	D29B	D29C	D29D	D29E	D29F	D29G	T29
SEG24	D28A	D28B	D28C	D28D	D28E	D28F	D28G	T28
SEG25	D27A	D27B	D27C	D27D	D27E	D27F	D27G	T27
SEG26	D26A	D26B	D26C	D26D	D26E	D26F	D26G	T26
SEG27	D25A	D25B	D25C	D25D	D25E	D25F	D25G	T25
SEG28	D24A	D24B	D24C	D24D	D24E	D24F	D24G	T24
SEG29	D23A	D23B	D23C	D23D	D23E	D23F	D23G	T23
SEG30	D19A	D19B	D19C	D19D	D19E	D19F	D19G	T19
SEG31	D18A	D18B	D18C	D18D	D18E	D18F	D18G	T18
SEG32	D17A	D17B	D17C	D17D	D17E	D17F	D17G	T17
SEG33	D16A	D16B	D16C	D16D	D16E	D16F	D16G	T16
SEG34	D15A	D15B	D15C	D15D	D15E	D15F	D15G	T15
SEG35	D14A	D14B	D14C	D14D	D14E	D14F	D14G	T14
SEG36	D13A	D13B	D13C	D13D	D13E	D13F	D13G	T13

Legend: DnX = Dot Matrix, Column n, Row X; Tn = Graphic Display Element n (see [Figure B-1](#) for details).

NOTES:

Appendix C. Optional Microphone Amplifier

By default, the electret microphone on the MPLAB Starter Kit for Intelligent.Integrated.Analog is configured as a simple audio detector; it does not provide sufficient amplification for voice or more advanced audio applications. To achieve better performance, a microphone amplifier needs to be implemented. The preferred design would be an AC-coupled amplifier with a gain of approximately 20:1, with the output DC-biased to 1.6V.

Figure C-1 shows a suggested implementation for this type of amplifier. Table C-1 provides the list of required components. The exact implementation in hardware is left to the user.

FIGURE C-1: MICROPHONE AMPLIFIER SCHEMATIC

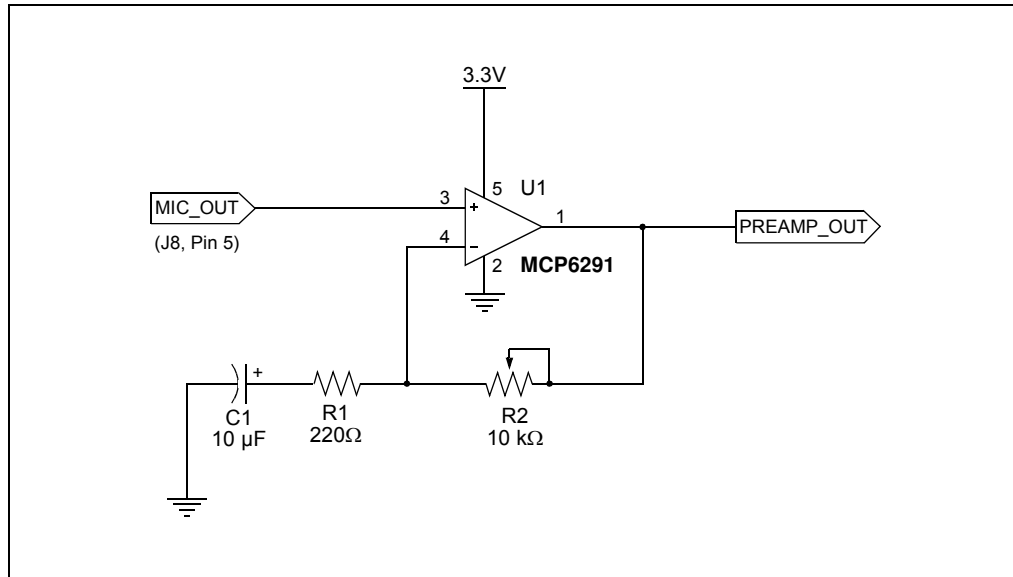

TABLE C-1: MICROPHONE AMPLIFIER COMPONENT LIST

Component	Description
C1	10 μ F, 16 WVDC Electrolytic Capacitor
R1	220 Ω , Resistor (\pm 5% tolerance or better) ⁽¹⁾
R2	10 k Ω Trim Potentiometer
U1	MCP6921-E/OT Operational Amplifier (SOT-23 package) ⁽¹⁾

Note 1: Specific part options depend on your choices for implementing the design. SOT-23 packaging options are shown for convenience; other options are available.

NOTES:



MPLAB® STARTER KIT FOR INTELLIGENT.INTEGRATED.ANALOG USER'S GUIDE

Index

A	
Ambient Light Sensor	16
Audio Output Driver	16
Audio/Microphone Demo	22
B	
Background Data Transmission	22
Battery Holder	17
Breakout Connectors	17
C	
Clock Demo	20
Customer Change Notification Service	11
Customer Support	12
D	
Device Drivers Installation	18
Documentation	
Conventions	9
Layout	8
H	
Hardware Considerations for New Applications	27
I	
Internet Address	11
L	
LCD Display	15
LCD Panel	
Technical Information	35
LCD Test Demo	21
M	
MCLR Push Button	15
Microchip Internet Web Site	11
Microphone	16
mTouch Navigation Pads	15
O	
Optional Microphone Amplifier	39
Other Hardware Resources	23
P	
PICkit On Board (PKOB)	15, 25
Pipeline A/D Demo	21
Potentiometer	15
Power Source Options	18
Precision Voltage Reference	16
R	
Reading, Recommended	10
Reduced Power (Sleep) Mode, Entering	22
Reprogramming the Starter Kit Using PKOB	25
Revision History	12
RF Transceiver Footprint	17
S	
Schematic Diagrams	31–34
Optional Microphone Amplifier	39
Sigma-Delta A/D Demo	20
Starter Kit Board	
Front/Back Views (figure)	14
Start-up Display	19
Stereo DAC Demo	21
SW1 Momentary Push Button	15
SWITCHED_VDD Control	18
T	
TC77 Temperature Sensor Demo	21
Temperature Sensor	16
Troubleshooting	29
U	
USB Connectors	15
User LEDs	15
W	
Warranty Registration	9
WWW Address	11



MICROCHIP

Worldwide Sales and Service

AMERICAS

Corporate Office
2355 West Chandler Blvd.
Chandler, AZ 85224-6199
Tel: 480-792-7200
Fax: 480-792-7277
Technical Support:
<http://www.microchip.com/support>
Web Address:
www.microchip.com

Atlanta
Duluth, GA
Tel: 678-957-9614
Fax: 678-957-1455

Boston
Westborough, MA
Tel: 774-760-0087
Fax: 774-760-0088

Chicago
Itasca, IL
Tel: 630-285-0071
Fax: 630-285-0075

Cleveland
Independence, OH
Tel: 216-447-0464
Fax: 216-447-0643

Dallas
Addison, TX
Tel: 972-818-7423
Fax: 972-818-2924

Detroit
Farmington Hills, MI
Tel: 248-538-2250
Fax: 248-538-2260

Indianapolis
Noblesville, IN
Tel: 317-773-8323
Fax: 317-773-5453

Los Angeles
Mission Viejo, CA
Tel: 949-462-9523
Fax: 949-462-9608

Santa Clara
Santa Clara, CA
Tel: 408-961-6444
Fax: 408-961-6445

Toronto
Mississauga, Ontario,
Canada
Tel: 905-673-0699
Fax: 905-673-6509

ASIA/PACIFIC

Asia Pacific Office
Suites 3707-14, 37th Floor
Tower 6, The Gateway
Harbour City, Kowloon
Hong Kong
Tel: 852-2401-1200
Fax: 852-2401-3431

Australia - Sydney
Tel: 61-2-9868-6733
Fax: 61-2-9868-6755

China - Beijing
Tel: 86-10-8569-7000
Fax: 86-10-8528-2104

China - Chengdu
Tel: 86-28-8665-5511
Fax: 86-28-8665-7889

China - Chongqing
Tel: 86-23-8980-9588
Fax: 86-23-8980-9500

China - Hangzhou
Tel: 86-571-2819-3187
Fax: 86-571-2819-3189

China - Hong Kong SAR
Tel: 852-2943-5100
Fax: 852-2401-3431

China - Nanjing
Tel: 86-25-8473-2460
Fax: 86-25-8473-2470

China - Qingdao
Tel: 86-532-8502-7355
Fax: 86-532-8502-7205

China - Shanghai
Tel: 86-21-5407-5533
Fax: 86-21-5407-5066

China - Shenyang
Tel: 86-24-2334-2829
Fax: 86-24-2334-2393

China - Shenzhen
Tel: 86-755-8864-2200
Fax: 86-755-8203-1760

China - Wuhan
Tel: 86-27-5980-5300
Fax: 86-27-5980-5118

China - Xian
Tel: 86-29-8833-7252
Fax: 86-29-8833-7256

China - Xiamen
Tel: 86-592-2388138
Fax: 86-592-2388130

China - Zhuhai
Tel: 86-756-3210040
Fax: 86-756-3210049

ASIA/PACIFIC

India - Bangalore
Tel: 91-80-3090-4444
Fax: 91-80-3090-4123

India - New Delhi
Tel: 91-11-4160-8631
Fax: 91-11-4160-8632

India - Pune
Tel: 91-20-2566-1512
Fax: 91-20-2566-1513

Japan - Osaka
Tel: 81-6-6152-7160
Fax: 81-6-6152-9310

Japan - Tokyo
Tel: 81-3-6880-3770
Fax: 81-3-6880-3771

Korea - Daegu
Tel: 82-53-744-4301
Fax: 82-53-744-4302

Korea - Seoul
Tel: 82-2-554-7200
Fax: 82-2-558-5932 or
82-2-558-5934

Malaysia - Kuala Lumpur
Tel: 60-3-6201-9857
Fax: 60-3-6201-9859

Malaysia - Penang
Tel: 60-4-227-8870
Fax: 60-4-227-4068

Philippines - Manila
Tel: 63-2-634-9065
Fax: 63-2-634-9069

Singapore
Tel: 65-6334-8870
Fax: 65-6334-8850

Taiwan - Hsin Chu
Tel: 886-3-5778-366
Fax: 886-3-5770-955

Taiwan - Kaohsiung
Tel: 886-7-213-7828
Fax: 886-7-330-9305

Taiwan - Taipei
Tel: 886-2-2508-8600
Fax: 886-2-2508-0102

Thailand - Bangkok
Tel: 66-2-694-1351
Fax: 66-2-694-1350

EUROPE

Austria - Wels
Tel: 43-7242-2244-39
Fax: 43-7242-2244-393

Denmark - Copenhagen
Tel: 45-4450-2828
Fax: 45-4485-2829

France - Paris
Tel: 33-1-69-53-63-20
Fax: 33-1-69-30-90-79

Germany - Munich
Tel: 49-89-627-144-0
Fax: 49-89-627-144-44

Italy - Milan
Tel: 39-0331-742611
Fax: 39-0331-466781

Netherlands - Drunen
Tel: 31-416-690399
Fax: 31-416-690340

Spain - Madrid
Tel: 34-91-708-08-90
Fax: 34-91-708-08-91

UK - Wokingham
Tel: 44-118-921-5869
Fax: 44-118-921-5820

11/29/12