

|   |  |
|---|--|
| <p>GlobTek, Inc.<br/>www.globtek.com<br/>186 Veterans Drive,<br/>Northvale, NJ 07647<br/>Tel. (201) 784-1000<br/>Fax (201) 784-0111</p> | <p>Drawing Title: GTM96605-G2A1-T2-RA, USB Power Delivery (PD) Source, ICT/ITE/Medical, Efficiency Level: USA DOE Level VI / Eco-design Directive 2009/125/EC, (EU) 2019/1782, Case Color/Style: GlobTek Black, Desktop/External, USB Adaptive Power Supply AC Adaptor, Input Rating: 100-240V~, 50-60Hz, IEC 60320/C8 , Output Rating: 60W, 5V, 5.8V, 9V, 12V, 15V, 15.1V, 20VV@4.6A, 4.6A, 4.4A, 4A, 3.6A, 3.6A, 3AA, Output Configuration: mm, / Cond, . , Ferrite: . , GT Cord # , Pin Out: +V: A4, A9, B4, B9, GND: A1, A12, B1, B12, CC1: A5, D+:A6, D-:A7, Blades/Input Cord: Not Applicable, Approvals: RCM; CE; PSE; WEEE; VCCI; RoHS; China RoHS; Level VI; Double Insulation; EAC; Ukraine; CB 60601-1 2MOPP (6W max); CB 60950; CB 62368; CCC; ETL 62368; ETL; cETLus 60601-1 3rd; cETLus 60601; RCM; S-Mark 60950; UKCA; Conforms to 62368-1; LPS 60950; Morocco;Morocco;</p> |
|   | <p>Model No. GTM96605-G2A1-T2-RA</p>   |
|   | <p>Part No./Ordering No. TR9KZ3000USBCRAR6B</p>  |
|   | <p>Rev A3</p>  |

In Addition to GlobTek Inc.'s renewed ISO9001:2015 - Quality Management System Certification, GlobTek Inc. is now certified to:

ISO13485:2016 - Medical Devices Quality Management System Certification  
ISO14001:2015 - Environmental Management System Certification

ISO Certificates are available online at <https://www.globtek.com/iso-certificates/>

The acceptance of this specification and use of the product described in this document indicates the acceptance and binding of the customer to Globtek TERMS AND CONDITIONS (attached to the end of this document), which supersede all other agreements, terms, and conditions (<https://en.globtek.com/terms-and-conditions/>).

The purchaser of this product (Customer) agrees that it is their sole responsibility to determine suitability/fitness of the product described in this specification for their application and to take precautions for protection against any hazards attendant to the handling and use of the product.

Footnote:

GlobTek Inc. will not be liable for the safety and performance of these power supplies/battery packs if unauthorized access and repair occurs. End user should consult applicable UL, CSA or EN standards for proper installation instruction.

Limitation of Use:

GlobTek products are intended for use with commercial, medical, and/or industrial equipment only. GlobTek product are not authorized for use as mission critical components in life support hazardous environment, nuclear or aircraft applications without prior written approval from the CEO of GlobTek Inc.

Contents of this document are subject to change without prior notice.

### Customer Approval of Specification:

Please approve, sign and send back to GlobTek so we can complete order processing.  
A delay in receipt of this form will delay delivery schedule.

|                                       |  |
|---------------------------------------|--|
| Company Name: _____                   | Customer P/N: _____                        |
| Quote Number: _____                   | Date: _____                                |
| Authorized Representative Name: _____ | Authorized Representative Signature: _____ |

|  |   |        |
|--|---|--------|
| <b>GlobTek, Inc.</b><br>www.globtek.com<br>186 Veterans Drive,<br>Northvale, NJ 07647<br>Tel. (201) 784-1000<br>Fax (201) 784-0111 | Drawing Title: GTM96605-G2A1-T2-RA, USB Power Delivery (PD) Source, ICT/ITE/Medical, Efficiency Level: USA DOE Level VI / Eco-design Directive 2009/125/EC, (EU) 2019/1782, Case Color/Style: GlobTek Black, Desktop/External, USB Adaptive Power Supply AC Adaptor, Input Rating: 100-240V~, 50-60Hz, IEC 60320/C8 , Output Rating: 60W, 5V, 5.8V, 9V, 12V, 15V, 15.1V, 20VV@4.6A, 4.6A, 4.4A, 4A, 3.6A, 3.6A, 3AA, Output Configuration: mm, / Cond, . , Ferrite: . , GT Cord # , Pin Out: +V: A4, A9, B4, B9, GND: A1, A12, B1, B12, CC1: A5, D+:A6, D-:A7, Blades/Input Cord: Not Applicable, Approvals: RCM; CE; PSE; WEEE; VCCI; RoHS; China RoHS; Level VI; Double Insulation; EAC; Ukraine; CB 60601-1 2MOPP (6W max); CB 60950; CB 62368; CCC; ETL 62368; ETL; cETLus 60601-1 3rd; cETLus 60601; RCM; S-Mark 60950; UKCA; Conforms to 62368-1; LPS 60950; Morocco;Morocco; |        |
|  | Model No. GTM96605-G2A1-T2-RA   |        |
|  | Part No./Ordering No. TR9KZ3000USBCRAR6B  | Rev A3 |

## REVISION HISTORY

| REV | DESCRIPTION  | SUB    | DATE       | APPROVED |
|-----|--|--------|------------|----------|
| A3  | Update firmware version from GTF-BAAC-3 to GTF-D336-3  | QA     | 06/21/2022 | QA       |
| A2  | Change engineering model from GTM96605-G2A1-T2 to GTM96605-G2A1-T2-RA, update firmware to GTF-BAAC-3 | QA     | 01/11/2022 | QA       |
| A1  | Add drawing to model with integrated USBC connector (suffix -RA)                                     | QA     | 07/14/2021 | QA       |
| A   | Initial release  | krakom | 06/11/2020 | MICHAEL  |

### POWER SUPPLY INFORMATION

|                                |   |
|--------------------------------|---|
| TYPE                           | Desktop/External  |
| TECHNOLOGY                     | USB Adaptive Power Supply AC Adaptor                                |
| FIRMWARE VER                   | GTF-D336-3  |
| CASE COLOR                     | GlobTek Black   |
| NAMEPLATE RATED INPUT          | 100-240V~, 50-60Hz, 1.5A  |
| INPUT CONFIG                   | IEC 60320/C8  |
| WATTS                          | 60.00   |
| VOLTS OUT                      | 5V, 5.8V, 9V, 12V, 15V, 15.1V, 20V                                  |
| CURRENT OUT (Amps)             | 4.6A, 4.6A, 4.4A, 4A, 3.6A, 3.6A, 3A                                |
| BLADE/CORD INCLUDED            | N/A Not Applicable  |
| BLADE/CORD INSTALLED           | N/A :Not Applicable   |
| INGRESS PROTECTION             |   |
| GROUNDING CONFIGURATION        | (F1) Class II / Double Insulated                                    |
| EFFICIENCY LEVEL               | USA DOE Level VI / Eco-design Directive 2009/125/EC, (EU) 2019/1782 |
| CONNECTOR PIN OUT              | +V: A4, A9, B4, B9, GND: A1, A12, B1, B12, CC1: A5, D+:A6, D-:A7    |
| LABEL SPECS                    | ISO 15223 medical device compliant label + FW,L-1624                |
| SPECIAL BARCODE LABEL MATERIAL | No  |
| PACK SPEC                      | Standard DT, Cellular packaging, User manual                        |
| USER MANUAL                    | 809-DESKTOPUSERMANUAL on A4 paper                                   |

#### PROPRIETARY INFORMATION

|   |  |               |
|---|--|---------------|
| <p>GlobTek, Inc.<br/>www.globtek.com<br/>186 Veterans Drive,<br/>Northvale, NJ 07647<br/>Tel. (201) 784-1000<br/>Fax (201) 784-0111</p> | <p>Drawing Title: GTM96605-G2A1-T2-RA, USB Power Delivery (PD) Source, ICT/ITE/Medical, Efficiency Level: USA DOE Level VI / Eco-design Directive 2009/125/EC, (EU) 2019/1782, Case Color/Style: GlobTek Black, Desktop/External, USB Adaptive Power Supply AC Adaptor, Input Rating: 100-240V~, 50-60Hz, IEC 60320/C8 , Output Rating: 60W, 5V, 5.8V, 9V, 12V, 15V, 15.1V, 20VV@4.6A, 4.6A, 4.4A, 4A, 3.6A, 3.6A, 3AA, Output Configuration: mm, / Cond, . , Ferrite: . , GT Cord # , Pin Out: +V: A4, A9, B4, B9, GND: A1, A12, B1, B12, CC1: A5, D+:A6, D-:A7, Blades/Input Cord: Not Applicable, Approvals: RCM; CE; PSE; WEEE; VCCI; RoHS; China RoHS; Level VI; Double Insulation; EAC; Ukraine; CB 60601-1 2MOPP (6W max); CB 60950; CB 62368; CCC; ETL 62368; ETL; cETLus 60601-1 3rd; cETLus 60601; RCM; S-Mark 60950; UKCA; Conforms to 62368-1; LPS 60950; Morocco;Morocco;</p> |               |
|   | <p>Model No. GTM96605-G2A1-T2-RA</p>   |               |
|   | <p>Part No./Ordering No. TR9KZ3000USBCRAR6B</p>  | <p>Rev A3</p> |

Notes/Modifications/Customizations (notes in this section supersede the values shown in the standard spec)  
DIMENSIONS ARE IN MM UNLESS SPECIFIED OTHERWISE

|  |   |        |
|--|---|--------|
| <b>GlobTek, Inc.</b><br>www.globtek.com<br>186 Veterans Drive,<br>Northvale, NJ 07647<br>Tel. (201) 784-1000<br>Fax (201) 784-0111 | Drawing Title: GTM96605-G2A1-T2-RA, USB Power Delivery (PD) Source, ICT/ITE/Medical, Efficiency Level: USA DOE Level VI / Eco-design Directive 2009/125/EC, (EU) 2019/1782, Case Color/Style: GlobTek Black, Desktop/External, USB Adaptive Power Supply AC Adaptor, Input Rating: 100-240V~, 50-60Hz, IEC 60320/C8 , Output Rating: 60W, 5V, 5.8V, 9V, 12V, 15V, 15.1V, 20VV@4.6A, 4.6A, 4.4A, 4A, 3.6A, 3.6A, 3AA, Output Configuration: mm, / Cond, . , Ferrite: . , GT Cord # , Pin Out: +V: A4, A9, B4, B9, GND: A1, A12, B1, B12, CC1: A5, D+:A6, D-:A7, Blades/Input Cord: Not Applicable, Approvals: RCM; CE; PSE; WEEE; VCCI; RoHS; China RoHS; Level VI; Double Insulation; EAC; Ukraine; CB 60601-1 2MOPP (6W max); CB 60950; CB 62368; CCC; ETL 62368; ETL; cETLus 60601-1 3rd; cETLus 60601; RCM; S-Mark 60950; UKCA; Conforms to 62368-1; LPS 60950; Morocco;Morocco; |        |
|  | Model No. GTM96605-G2A1-T2-RA   |        |
|  | Part No./Ordering No. TR9KZ3000USBCRAR6B  | Rev A3 |

## ELECTRICAL SPECIFICATIONS

### USB Power Delivery Capabilities

|                                       |  |
|---------------------------------------|--|
| Protocols supported:                  | USB Power Delivery (PD) 2.0/3.0 + PPS  |
| Default Output State:                 | 5V/2.0A  |
| Advertised Power Data Objects (PDOs): | Standard option: 5V, 5.8V, 9V, 12V, 15V, 15.1V <sup>†</sup> , 20V<br>PPS option: 5V, 9V, 15V, 20V, PPS (3.6-11V), PPS (3.6-16V), PPS (3.6-20V)<br>Refer to the 'Rating Table' for output current capability for each USB PD PDO.   |
| Output Current:                       | Models with -RA suffix have a female USB Type-C connector for use with a detachable USB Type-C cable. If no E-marked cable is detected, the maximum current is limited to 3A.<br><br>Models without a suffix have a captive 5A rated cable and can always deliver the full current per the 'Rating Table'.   |
| Note 1:                               | Custom fixed PDOs available upon request. PDO1 must be 5V. PDO2 through PDO7 may be set to any custom voltage from 3.6V to 20V, with a step size of 100mV.   |
| Note 2:                               | In critical applications, the use of a non-authorized USB PD power adapter may pose a substantial risk. The power adapter's identity may be checked and validated prior to PD contract negotiation by using USB PD Vendor Defined Messages (VDMs). Please see our article <a href="#">Product Security and Risk Mitigation for USB Power Delivery (PD) Based Systems</a> for additional information. |

### Qualcomm Quick Charge™ Capabilities

| Protocols supported:    | Quick Charge™ 2.0/3.0  |  |           |        |      |     |           |      |      |           |      |      |          |      |      |          |      |      |  |
|-------------------------|--|--|-----------|--------|------|-----|-----------|------|------|-----------|------|------|----------|------|------|----------|------|------|--|
| Default Output State:   | 5V/2.0A  |  |           |        |      |     |           |      |      |           |      |      |          |      |      |          |      |      |  |
| HVDCP Class B Profiles: | <table border="1"> <thead> <tr> <th>D+</th> <th>D-</th> <th>Output</th> </tr> </thead> <tbody> <tr> <td>0.6V</td> <td>GND</td> <td>5.0V/4.6A</td> </tr> <tr> <td>3.3V</td> <td>0.6V</td> <td>9.0V/4.4A</td> </tr> <tr> <td>0.6V</td> <td>0.6V</td> <td>12V/4.0A</td> </tr> <tr> <td>3.3V</td> <td>3.3V</td> <td>20V/3.0A</td> </tr> <tr> <td>0.6V</td> <td>3.3V</td> <td>Continuous mode. Adjust from 3.6V to 20V in 200mV steps.</td> </tr> </tbody> </table> | D+   | D-        | Output | 0.6V | GND | 5.0V/4.6A | 3.3V | 0.6V | 9.0V/4.4A | 0.6V | 0.6V | 12V/4.0A | 3.3V | 3.3V | 20V/3.0A | 0.6V | 3.3V | Continuous mode. Adjust from 3.6V to 20V in 200mV steps. |
|                         | D+   | D-   | Output    |        |      |     |           |      |      |           |      |      |          |      |      |          |      |      |  |
|                         | 0.6V   | GND  | 5.0V/4.6A |        |      |     |           |      |      |           |      |      |          |      |      |          |      |      |  |
|                         | 3.3V   | 0.6V   | 9.0V/4.4A |        |      |     |           |      |      |           |      |      |          |      |      |          |      |      |  |
|                         | 0.6V   | 0.6V   | 12V/4.0A  |        |      |     |           |      |      |           |      |      |          |      |      |          |      |      |  |
| 3.3V                    | 3.3V   | 20V/3.0A   |           |        |      |     |           |      |      |           |      |      |          |      |      |          |      |      |  |
| 0.6V                    | 3.3V   | Continuous mode. Adjust from 3.6V to 20V in 200mV steps. |           |        |      |     |           |      |      |           |      |      |          |      |      |          |      |      |  |
| Output Current:         | Models with -RA suffix are limited to 3A, as Quick Charge does not support USB PD E-marked cables.<br><br>Models without a suffix can deliver full rated Quick Charge current.   |  |           |        |      |     |           |      |      |           |      |      |          |      |      |          |      |      |  |

### Input

Specified: 90-264VAC, Nameplate: 100-240VAC  
100% rated load current for 90-264VAC

|  |   |        |
|--|---|--------|
| <b>GlobTek, Inc.</b><br>www.globtek.com<br>186 Veterans Drive,<br>Northvale, NJ 07647<br>Tel. (201) 784-1000<br>Fax (201) 784-0111 | Drawing Title: GTM96605-G2A1-T2-RA, USB Power Delivery (PD) Source, ICT/ITE/Medical, Efficiency Level: USA DOE Level VI / Eco-design Directive 2009/125/EC, (EU) 2019/1782, Case Color/Style: GlobTek Black, Desktop/External, USB Adaptive Power Supply AC Adaptor, Input Rating: 100-240V~, 50-60Hz, IEC 60320/C8 , Output Rating: 60W, 5V, 5.8V, 9V, 12V, 15V, 15.1V, 20VV@4.6A, 4.6A, 4.4A, 4A, 3.6A, 3.6A, 3AA, Output Configuration: mm, / Cond, . , Ferrite: . , GT Cord # , Pin Out: +V: A4, A9, B4, B9, GND: A1, A12, B1, B12, CC1: A5, D+:A6, D-:A7, Blades/Input Cord: Not Applicable, Approvals: RCM; CE; PSE; WEEE; VCCI; RoHS; China RoHS; Level VI; Double Insulation; EAC; Ukraine; CB 60601-1 2MOPP (6W max); CB 60950; CB 62368; CCC; ETL 62368; ETL; cETLus 60601-1 3rd; cETLus 60601; RCM; S-Mark 60950; UKCA; Conforms to 62368-1; LPS 60950; Morocco;Morocco; |        |
|  | Model No. GTM96605-G2A1-T2-RA   |        |
|  | Part No./Ordering No. TR9KZ3000USBCRAR6B  | Rev A3 |

|                      |   |
|----------------------|---|
| Input Voltage:       | 85% rated load current for 85-264VAC<br>100% rated load current for 110-370VDC                                    |
| Input Frequency:     | Specified: 47-63Hz, Nameplate: 50-60Hz  |
| No Load Input Power: | < 75mW @ 230VAC (EU CoC Tier 2 compliant)   |
| Inrush Current:      | < 30A @ 115VAC, < 60A @ 230VAC (cold start)   |
| Efficiency:          | DoE Efficiency Level VI and CoC Tier 2 compliant (tested according to DoE 10 CFR Part 430, Subpart B, Appendix Z) |

## Output

|                     |  |
|---------------------|--|
| Turn-on Delay:      | < 1 second (full load, 115VAC)   |
| Output Regulation   | ± 4% max. (measured at the end of output cord)   |
| Line Regulation:    | ± 0.5% typ. (measured at the end of output cord)   |
| Ripple:             | 100mV max. (using a 47µF low-ESR electrolytic cap + 0.1µF ceramic cap, measured @ 20MHz BW, at the output connector) |
| Transient Response: | 5% max. deviation, 1ms max. recovery time (with 40 to 70% load step),  |
| Hold-up Time:       | 8ms typ. (full load, nominal line voltage)   |
| Power Indicator:    | Green LED  |

## Protections

|                              |   |
|------------------------------|---|
| Input Protection:            | MOV transient suppressor, input line fusing   |
| Over-Voltage Protection:     | Level 1: 110-130%, Auto-recovery, adaptive to selected PDO/QC profile<br>Level 2: 25V (max), Latched off, cycle AC to reset |
| Over-Current Protection:     | 110-140%, Auto-recovery, adaptive to selected PDO/QC profile  |
| Short-Circuit Protection:    | Auto-recovery   |
| Over-Temperature Protection: | Auto-recovery   |

## Environmental

|                        |   |
|------------------------|---|
| MTBF:                  | 1,500,000 hours @ 25°C ambient, full load (Telcordia SR-332, Issue 3) |
| Operating Temperature: | -10°C to 40°C (full load)<br>-10°C to 50°C (80% load)                 |
| Storage Temperature:   | -30°C to 80°C   |
| Humidity:              | 0% to 95% relative humidity, non-condensing                           |
| Altitude               | 5000m   |
| Cooling:               | Convection  |
| RoHS:                  | Complies with EU 2011/65/EU and China SJ/T 11363-2006                 |

## Safety

|                               |   |
|-------------------------------|---|
| Dielectric Withstand Voltage: | 4000VAC or 5656VDC from input to output |
|-------------------------------|---|

|  |   |        |
|--|---|--------|
| <b>GlobTek, Inc.</b><br>www.globtek.com<br>186 Veterans Drive,<br>Northvale, NJ 07647<br>Tel. (201) 784-1000<br>Fax (201) 784-0111 | Drawing Title: GTM96605-G2A1-T2-RA, USB Power Delivery (PD) Source, ICT/ITE/Medical, Efficiency Level: USA DOE Level VI / Eco-design Directive 2009/125/EC, (EU) 2019/1782, Case Color/Style: GlobTek Black, Desktop/External, USB Adaptive Power Supply AC Adaptor, Input Rating: 100-240V~, 50-60Hz, IEC 60320/C8 , Output Rating: 60W, 5V, 5.8V, 9V, 12V, 15V, 15.1V, 20VV@4.6A, 4.6A, 4.4A, 4A, 3.6A, 3.6A, 3AA, Output Configuration: mm, / Cond, . , Ferrite: . , GT Cord # , Pin Out: +V: A4, A9, B4, B9, GND: A1, A12, B1, B12, CC1: A5, D+:A6, D-:A7, Blades/Input Cord: Not Applicable, Approvals: RCM; CE; PSE; WEEE; VCCI; RoHS; China RoHS; Level VI; Double Insulation; EAC; Ukraine; CB 60601-1 2MOPP (6W max); CB 60950; CB 62368; CCC; ETL 62368; ETL; cETLus 60601-1 3rd; cETLus 60601; RCM; S-Mark 60950; UKCA; Conforms to 62368-1; LPS 60950; Morocco/Morocco; |        |
|  | Model No. GTM96605-G2A1-T2-RA   |        |
|  | Part No./Ordering No. TR9KZ3000USBCRAR6B  | Rev A3 |

|                           |  |
|---------------------------|--|
| Touch Current:            | 3-conductor models: 20µA max.<br>2-conductor models: 65µA max.   |
| Earth Leakage Current     | 300µA max. NC/SFC (N/A for 2-conductor input models)   |
| Means of Protection:      | 2 x MOPP   |
| Output Isolation Options: | -T2/R2 suffix: Class II 2-conductor (C8/C18 inlet or interchangeable blades)<br>-T3/R3 suffix: Class II, with functional earth (FE) (C6/C14 inlet or interchangeable blades)<br>Class I, earth wire connected directly to output negative (C6/C14 inlet or interchangeable blades) |
| Note 3:                   | Review output isolation options with our article: <a href="#">PSU Isolation and Identify</a>   |

## EMC

|  |   |
|--|---|
| Applicable Standards:                    | Medical: EN 60601-1-2 (4e)<br>Emissions: EN55032, EN61000-6-3, EN61000-6-4<br>Immunity: EN55024, EN61000-6-1 (4e), EN61000-6-2 (4e) |
| Conducted Emissions:                     | Class B, FCC Part 15, Class B (with resistive load)   |
| Radiated Emissions:                      | Class B, FCC Part 15, Class B (with resistive load)   |
| Harmonic Current Voltage Distortion:     | EN61000-3-2, Class A  |
| Voltage Fluctuations/Flicker:            | EN61000-3-3   |
| Electrostatic Discharge (ESD) Immunity:  | EN61000-4-2, 10KV contact discharge, 18KV air discharge, Criterion A  |
| Radiated RF Immunity:                    | EN61000-4-3, 10V/m @ 80-1000MHz, 3V/m @ 1-2.7GHz, 80% 1KHz AM, Criterion A  |
| EFT/Burst Immunity:                      | EN61000-4-4, 2KV/100KHz., Criterion A; 4KV/100KHz, Criterion B  |
| Line Surge Immunity:                     | EN61000-4-5, 2KV differential, 2KV common-mode, Criterion A; 4KV common-mode, Criterion B   |
| Conducted RF Immunity:                   | EN61000-4-6, 3VRMS, 80% 1KHz AM, Criterion A  |
| Power Frequency Magnetic Field Immunity: | EN61000-4-8, 30A/m, Criterion A   |
| Voltage Dip Immunity:                    | EN61000-4-11, Criterion B   |

## Enclosure

|           |  |
|-----------|--|
| Housing:  | High impact plastic, 94V0 polycarbonate, non-vented<br>Desktop T2/T3: C6, C8, C14, or C18 IEC inlet<br>Hybrid (desktop or wall plug-in): Class I or Class II input |
| Markings: | No suffix: Captive 1.5m shielded USB Type-C cable<br>-RA suffix: Female USB Type-C connector integrated into housing<br>Adhesive backed label or laser engraving   |

## Prevention of Unauthorized Use

In critical applications, the use of a non-authorized USB PD power adapter may pose a substantial risk to system safety or performance.

The power adapter's identity may be checked and validated prior to PD contract negotiation by use

|  |   |        |
|--|---|--------|
| GloTek, Inc.<br>www.globtek.com<br>186 Veterans Drive,<br>Northvale, NJ 07647<br>Tel. (201) 784-1000<br>Fax (201) 784-0111 | Drawing Title: GTM96605-G2A1-T2-RA, USB Power Delivery (PD) Source, ICT/ITE/Medical, Efficiency Level: USA DOE Level VI / Eco-design Directive 2009/125/EC, (EU) 2019/1782, Case Color/Style: GlobTek Black, Desktop/External, USB Adaptive Power Supply AC Adaptor, Input Rating: 100-240V~, 50-60Hz, IEC 60320/C8 , Output Rating: 60W, 5V, 5.8V, 9V, 12V, 15V, 15.1V, 20VV@4.6A, 4.6A, 4.4A, 4A, 3.6A, 3.6A, 3AA, Output Configuration: mm, / Cond, . . , Ferrite: . . , GT Cord # , Pin Out: +V: A4, A9, B4, B9, GND: A1, A12, B1, B12, CC1: A5, D+:A6, D-:A7, Blades/Input Cord: Not Applicable, Approvals: RCM; CE; PSE; WEEE; VCCI; RoHS; China RoHS; Level VI; Double Insulation; EAC; Ukraine; CB 60601-1 2MOPP (6W max); CB 60950; CB 62368; CCC; ETL 62368; ETL; cETLus 60601-1 3rd; cETLus 60601; RCM; S-Mark 60950; UKCA; Conforms to 62368-1; LPS 60950; Morocco;Morocco; |        |
|  | Model No. GTM96605-G2A1-T2-RA   |        |
|  | Part No./Ordering No. TR9KZ3000USBCRAR6B  | Rev A3 |

|                     |   |
|---------------------|---|
| USB Power Delivery: | of USB PD Vendor Defined Messages (VDMs). The power adapter will respond to a USB PD "Discover Identity" VDM with 0x4754 in the "ProductID" field.<br><br>Additionally, non-standard 5.8V and 15.1V PDOs are included. Host systems may be designed to reject a power adapter which does not contain one of these PDOs. |
| Note 4:             | These measures do not guarantee a secure implementation, and are only suggested as a method of risk mitigation.   |
| Note 5:             | Please see our article <a href="#">Product Security and Risk Mitigation for USB Power Delivery (PD) Based Systems</a> for additional information.   |

## Special Options

Non-standard - Contact GlobTek

1. Custom housing and output cord colors
2. Custom fixed output cord length, for applicable models (1m, 2m, 3m lengths,etc.)
3. Custom markings and marking methods
4. Custom USB PD PDOs: Output voltages selectable between 5V and 20V, in 100mV increments
5. USB Micro-B connector for Quick Charge™-only applications
6. Quick Charge™ 4.0/4.0+ support

† 15.1V PDO is standard on units with date codes after Sept-10-2019.

†† VDM functionality is standard on units with date codes after Sept-10-2019.

TO ADDRESS SYSTEM-LEVEL EMI CONCERNS, FERRITE CHOKES/BEADS MAY BE ADDED/REVISED UPON REQUEST. A SAMPLE KIT OF GLOBTEK'S STANDARD FERRITES IS AVAILABLE UNDER GLOBTEK P/N: EMI-MITIGATION-KIT1

FOR ADDITIONAL INFORMATION, PLEASE READ OUR WHITE PAPER AT: <https://r.globtek.info/3QeaqtD>

|  |  |  |
|--|--|--|
| <p>GlobTek, Inc.<br/> www.globtek.com<br/> 186 Veterans Drive,<br/> Northvale, NJ 07647<br/> Tel. (201) 784-1000<br/> Fax (201) 784-0111</p> | <p>Drawing Title: GTM96605-G2A1-T2-RA, USB Power Delivery (PD) Source, ICT/ITE/Medical, Efficiency Level: USA DOE Level VI / Eco-design Directive 2009/125/EC, (EU) 2019/1782, Case Color/Style: GlobTek Black, Desktop/External, USB Adaptive Power Supply AC Adaptor, Input Rating: 100-240V~, 50-60Hz, IEC 60320/C8 , Output Rating: 60W, 5V, 5.8V, 9V, 12V, 15V, 15.1V, 20VV@4.6A, 4.6A, 4.4A, 4A, 3.6A, 3.6A, 3AA, Output Configuration: mm, / Cond, . , Ferrite: . , GT Cord # , Pin Out: +V: A4, A9, B4, B9, GND: A1, A12, B1, B12, CC1: A5, D+:A6, D-:A7, Blades/Input Cord: Not Applicable, Approvals: RCM; CE; PSE; WEEE; VCCI; RoHS; China RoHS; Level VI; Double Insulation; EAC; Ukraine; CB 60601-1 2MOPP (6W max); CB 60950; CB 62368; CCC; ETL 62368; ETL; cETLus 60601-1 3rd; cETLus 60601; RCM; S-Mark 60950; UKCA; Conforms to 62368-1; LPS 60950; Morocco/Morocco;</p> | <p>Model No. GTM96605-G2A1-T2-RA<br/> Part No./Ordering No. TR9KZ3000USBCRAR6B<br/> Rev A3</p> |
|--|--|--|

3D File Download <https://www.globtek.com/dl/GTM96605-T2.igs>

Mechanical drawing

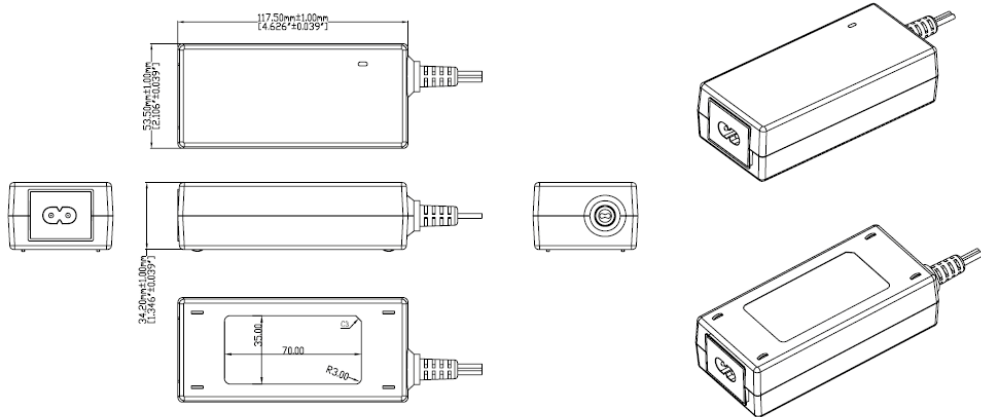

Drawing above is model with output cord

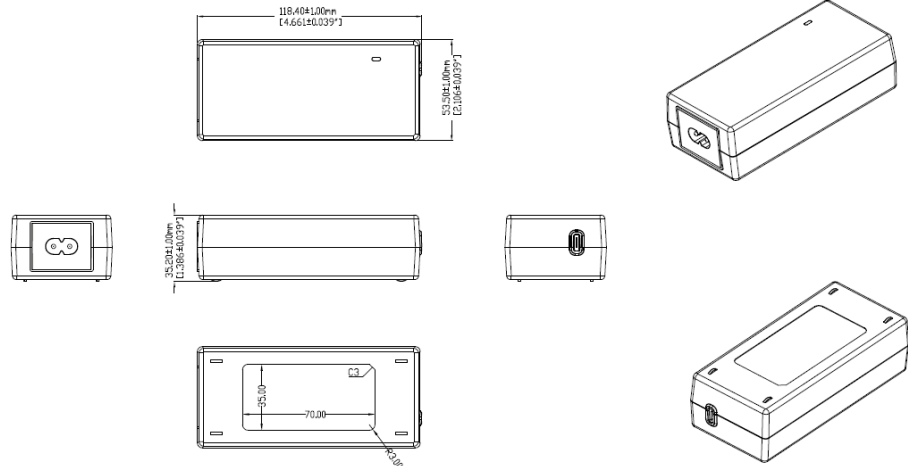

Drawing above is model with integrated USB-C connector (suffix -RA)



|   |   |               |
|---|---|---------------|
| <p>GlobTek, Inc.<br/>www.globtek.com<br/>186 Veterans Drive,<br/>Northvale, NJ 07647<br/>Tel. (201) 784-1000<br/>Fax (201) 784-0111</p> | <p>Drawing Title: GTM96605-G2A1-T2-RA, USB Power Delivery (PD) Source, ICT/ITE/Medical, Efficiency Level: USA DOE Level VI / Eco-design Directive 2009/125/EC, (EU) 2019/1782, Case Color/Style: GlobTek Black, Desktop/External, USB Adaptive Power Supply AC Adaptor, Input Rating: 100-240V~, 50-60Hz, IEC 60320/C8 , Output Rating: 60W, 5V, 5.8V, 9V, 12V, 15V, 15.1V, 20VV@4.6A, 4.6A, 4.4A, 4A, 3.6A, 3.6A, 3AA, Output Configuration: mm, / Cond, . , Ferrite: . , GT Cord # , Pin Out: +V: A4, A9, B4, B9, GND: A1, A12, B1, B12, CC1: A5, D+:A6, D-:A7, Blades/Input Cord: Not Applicable, Approvals: RCM; CE; PSE; WEEE; VCCI; RoHS; China RoHS; Level VI; Double Insulation; EAC; Ukraine; CB 60601-1 2MOPP (6W max); CB 60950; CB 62368; CCC; ETL 62368; ETL; cETLus 60601-1 3rd; cETLus 60601; RCM; S-Mark 60950; UKCA; Conforms to 62368-1; LPS 60950; Morocco/Morocco;</p> <p>Model No. GTM96605-G2A1-T2-RA</p> <p>Part No./Ordering No. TR9KZ3000USBCRAR6B</p> | <p>Rev A3</p> |
|---|---|---------------|

DERATING CURVE

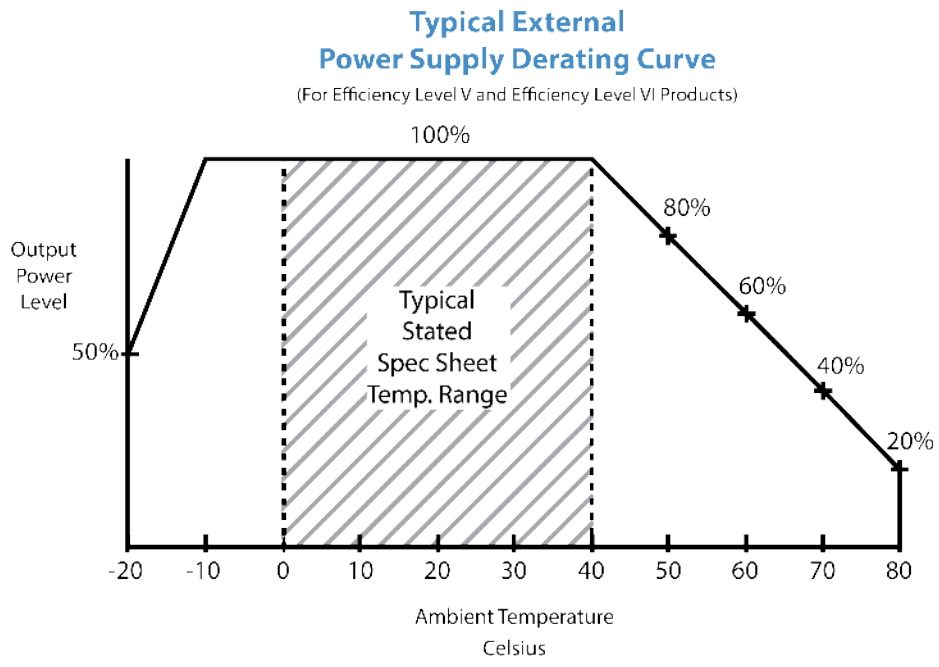

|  |   |        |
|--|---|--------|
| GloTek, Inc.<br>www.globtek.com<br>186 Veterans Drive,<br>Northvale, NJ 07647<br>Tel. (201) 784-1000<br>Fax (201) 784-0111 | Drawing Title: GTM96605-G2A1-T2-RA, USB Power Delivery (PD) Source, ICT/ITE/Medical, Efficiency Level: USA DOE Level VI / Eco-design Directive 2009/125/EC, (EU) 2019/1782, Case Color/Style: GlobTek Black, Desktop/External, USB Adaptive Power Supply AC Adaptor, Input Rating: 100-240V~, 50-60Hz, IEC 60320/C8 , Output Rating: 60W, 5V, 5.8V, 9V, 12V, 15V, 15.1V, 20VV@4.6A, 4.6A, 4.4A, 4A, 3.6A, 3.6A, 3AA, Output Configuration: mm, / Cond, . , Ferrite: . , GT Cord # , Pin Out: +V: A4, A9, B4, B9, GND: A1, A12, B1, B12, CC1: A5, D+:A6, D-:A7, Blades/Input Cord: Not Applicable, Approvals: RCM; CE; PSE; WEEE; VCCI; RoHS; China RoHS; Level VI; Double Insulation; EAC; Ukraine; CB 60601-1 2MOPP (6W max); CB 60950; CB 62368; CCC; ETL 62368; ETL; cETLus 60601-1 3rd; cETLus 60601; RCM; S-Mark 60950; UKCA; Conforms to 62368-1; LPS 60950; Morocco/Morocco; |        |
|  | Model No. GTM96605-G2A1-T2-RA   |        |
|  | Part No./Ordering No. TR9KZ3000USBCRAR6B  | Rev A3 |

**INPUT CONFIGURATION**

(F1) Class II / Double Insulated



[Alternate grounding configurations](#) available upon request.

Blades/Cord Included:N/A:Not Applicable

Blades/Cord Installed:N/A:Not Applicable

IEC 60320/C8 AC Inlet connector, Class II, Non-Earth Ground (aka "Figure-8")

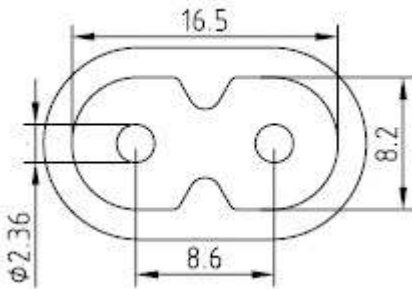

Mates with IEC 60320/C7 Plug

Below are standard cordsets which are "not included" (unless stated above); these may be purchased separately or packaged with the power supply. Please contact your Sales Engineer if the style required is not shown below. Many more available in different lengths, colors or cable material.

[Standard International IEC 320/C7 Cordsets](#)

| Part Number                         | Type                                | Standard  | Connector  | Length (mm) | Length (feet) |
|-------------------------------------|-------------------------------------|-----------|------------|-------------|---------------|
| <a href="#">2094112M703(R)</a>      | Argentina (Type I)                  | IRAM 2063 | IEC 320/C7 | 2000        | 7             |
| <a href="#">5014112M703A(R)</a>     | Australian (Type I)                 | AS 3112   | IEC 320/C7 | 2000        | 7             |
| <a href="#">207B4111M8703(R)</a>    | Brazil (Type N)                     | NBR14136  | IEC 320/C7 | 1800        | 6             |
| <a href="#">4533501M8703(R)</a>     | China (Type A)                      | GB 2099.1 | IEC 320/C7 | 1830        | 6             |
| <a href="#">2074112M703A(R)</a>     | European (Type C)                   | CEE 7/16  | IEC 320/C7 | 2000        | 7             |
| <a href="#">2074112M703AEUSA(R)</a> | European/South Africa Combo(Type C) | CEE 7/16  | IEC 320/C7 | 2000        | 7             |
| <a href="#">2084111M8703B(R)</a>    | India (Type D)                      | IS 1293   | IEC 320/C7 | 1800        | 6             |

**PROPRIETARY INFORMATION**

|  |   |        |
|--|---|--------|
| GloTek, Inc.<br>www.globtek.com<br>186 Veterans Drive,<br>Northvale, NJ 07647<br>Tel. (201) 784-1000<br>Fax (201) 784-0111 | Drawing Title: GTM96605-G2A1-T2-RA, USB Power Delivery (PD) Source, ICT/ITE/Medical, Efficiency Level: USA DOE Level VI / Eco-design Directive 2009/125/EC, (EU) 2019/1782, Case Color/Style: GlobTek Black, Desktop/External, USB Adaptive Power Supply AC Adaptor, Input Rating: 100-240V~, 50-60Hz, IEC 60320/C8 , Output Rating: 60W, 5V, 5.8V, 9V, 12V, 15V, 15.1V, 20VV@4.6A, 4.6A, 4.4A, 4A, 3.6A, 3.6A, 3AA, Output Configuration: mm, / Cond, . , Ferrite: . , GT Cord # , Pin Out: +V: A4, A9, B4, B9, GND: A1, A12, B1, B12, CC1: A5, D+:A6, D-:A7, Blades/Input Cord: Not Applicable, Approvals: RCM; CE; PSE; WEEE; VCCI; RoHS; China RoHS; Level VI; Double Insulation; EAC; Ukraine; CB 60601-1 2MOPP (6W max); CB 60950; CB 62368; CCC; ETL 62368; ETL; cETLus 60601-1 3rd; cETLus 60601; RCM; S-Mark 60950; UKCA; Conforms to 62368-1; LPS 60950; Morocco/Morocco; |        |
|  | Model No. GTM96605-G2A1-T2-RA   |        |
|  | Part No./Ordering No. TR9KZ3000USBCRAR6B  | Rev A3 |

|                                  |   |              |            |      |   |
|----------------------------------|---|--------------|------------|------|---|
| <a href="#">451J3401M8703(R)</a> | Japan (Type A)  | JIS 8303     | IEC 320/C7 | 1830 | 6 |
| <a href="#">2044112M703A(R)</a>  | Korea (Type C)  | KS C8305     | IEC 320/C7 | 2000 | 7 |
| <a href="#">4511116F703A(R)</a>  | North America (Type A)  | NEMA 1-15P   | IEC 320/C7 | 1830 | 6 |
| <a href="#">2084111M8703(R)</a>  | South Africa (Type M)   | BS 546       | IEC320/C7  | 1830 | 6 |
| <a href="#">4033401M8703A(R)</a> | Taiwan (Type A)   | CNS690       | IEC 320/C7 | 1830 | 6 |
| <a href="#">6104112M703A(R)</a>  | UK, Hong Kong,<br>Singapore, Gulf States<br>(Type G)  | BS1363       | IEC 320/C7 | 2000 | 7 |
| <a href="#">451G1116F703A(R)</a> | Gulf States (Kuwait,<br>Bahrain, Oman, Qatar,<br>Saudi Arabia, Yemen<br>and the United Arab<br>Emirates (UAE)(Type A) | Nema 1-15P   | IEC320/C7  | 1830 | 6 |
| <a href="#">6303742M5703(R)</a>  | Thailand (Type C)   | TIS 166-2549 | IEC320/C7  | 2500 | 8 |

|  |   |        |
|--|---|--------|
| GloTek, Inc.<br>www.globtek.com<br>186 Veterans Drive,<br>Northvale, NJ 07647<br>Tel. (201) 784-1000<br>Fax (201) 784-0111 | Drawing Title: GTM96605-G2A1-T2-RA, USB Power Delivery (PD) Source, ICT/ITE/Medical, Efficiency Level: USA DOE Level VI / Eco-design Directive 2009/125/EC, (EU) 2019/1782, Case Color/Style: GlobTek Black, Desktop/External, USB Adaptive Power Supply AC Adaptor, Input Rating: 100-240V~, 50-60Hz, IEC 60320/C8 , Output Rating: 60W, 5V, 5.8V, 9V, 12V, 15V, 15.1V, 20VV@4.6A, 4.6A, 4.4A, 4A, 3.6A, 3.6A, 3AA, Output Configuration: mm, / Cond, . . , Ferrite: . . , GT Cord # , Pin Out: +V: A4, A9, B4, B9, GND: A1, A12, B1, B12, CC1: A5, D+:A6, D-:A7, Blades/Input Cord: Not Applicable, Approvals: RCM; CE; PSE; WEEE; VCCI; RoHS; China RoHS; Level VI; Double Insulation; EAC; Ukraine; CB 60601-1 2MOPP (6W max); CB 60950; CB 62368; CCC; ETL 62368; ETL; cETLus 60601-1 3rd; cETLus 60601; RCM; S-Mark 60950; UKCA; Conforms to 62368-1; LPS 60950; Morocco;Morocco; |        |
|  | Model No. GTM96605-G2A1-T2-RA   |        |
|  | Part No./Ordering No. TR9KZ3000USBCRAR6B  | Rev A3 |

**OUTPUT CORD AND CONNECTOR:**

ACTUAL CONNECTORS, OVERMOLDS, FERRITES MAY VARY SLIGHTLY FROM THE PICTURE BELOW

CABLE TYPE

CABLE LENGTH (mm)

CABLE TOLERANCE (mm)

WIRE GAUGE (AWG)

CONDUCTORS

HANK DIMENSION (mm)

CABLE / CONNECTOR OVERMOLD COLOR

FERRITE TYPE AND DIMENSION

FERRITE NUMBER OF TURNS [\(Definition\)](#)

FERRITE DIMENSION FROM STRAIN

RELIEF

FERRITE DIMENSION FROM PLUG

|                   |  |
|-------------------|--|
| CONNECTOR PIN OUT | +V: A4, A9, B4, B9,<br>GND: A1, A12, B1, B12,<br>CC1: A5,<br>D+:A6,<br>D-:A7 |
|-------------------|--|

ADDITIONAL OUTPUT PLUG OPTIONS ARE AVAILABLE AT <https://www.globtek.com/connectors/>

STANDARD PLUGS AND CONNECTORS CAN BE SEEN ONLINE AT <https://www.globtek.com/connectors/>

CALCULATE VOLTAGE REGULATION/DROP WITH OUR ONLINE CALCULATOR: <https://en.globtek.com/output-cable-regulation-calculator/>

|  |  |
|--|--|
| <p>GlobTek, Inc.<br/> www.globtek.com<br/> 186 Veterans Drive,<br/> Northvale, NJ 07647<br/> Tel. (201) 784-1000<br/> Fax (201) 784-0111</p> | <p>Drawing Title: GTM96605-G2A1-T2-RA, USB Power Delivery (PD) Source, ICT/ITE/Medical, Efficiency Level: USA DOE Level VI / Eco-design Directive 2009/125/EC, (EU) 2019/1782, Case Color/Style: GlobTek Black, Desktop/External, USB Adaptive Power Supply AC Adaptor, Input Rating: 100-240V~, 50-60Hz, IEC 60320/C8 , Output Rating: 60W, 5V, 5.8V, 9V, 12V, 15V, 15.1V, 20VV@4.6A, 4.6A, 4.4A, 4A, 3.6A, 3.6A, 3AA, Output Configuration: mm, / Cond, . , Ferrite: . , GT Cord # , Pin Out: +V: A4, A9, B4, B9, GND: A1, A12, B1, B12, CC1: A5, D+:A6, D-:A7, Blades/Input Cord: Not Applicable, Approvals: RCM; CE; PSE; WEEE; VCCI; RoHS; China RoHS; Level VI; Double Insulation; EAC; Ukraine; CB 60601-1 2MOPP (6W max); CB 60950; CB 62368; CCC; ETL 62368; ETL; cETLus 60601-1 3rd; cETLus 60601; RCM; S-Mark 60950; UKCA; Conforms to 62368-1; LPS 60950; Morocco;Morocco;</p> |
|  | <p>Model No. GTM96605-G2A1-T2-RA</p>   |
|  | <p>Part No./Ordering No. TR9KZ3000USBCRAR6B <span style="float: right;">Rev A3</span></p>  |

**OUTPUT CONNECTOR HOOK UP**

TO ADDRESS SYSTEM-LEVEL EMI CONCERNS, FERRITE CHOKES/BEADS MAY BE ADDED/REVISED UPON REQUEST. A SAMPLE KIT OF GLOBTEK'S STANDARD FERRITES IS AVAILABLE UNDER GLOBTEK P/N: EMI-MITIGATION-KIT1

FOR ADDITIONAL INFORMATION, PLEASE READ OUR WHITE PAPER AT:

<https://en.globtek.com/technical-articles/ferrite-kit-radiated-emi-suppression-kit-for-globtek-power-supplies-cable-assemblies>

|   |   |        |
|---|---|--------|
| GlobTek, Inc.<br>www.globtek.com<br>186 Veterans Drive,<br>Northvale, NJ 07647<br>Tel. (201) 784-1000<br>Fax (201) 784-0111 | Drawing Title: GTM96605-G2A1-T2-RA, USB Power Delivery (PD) Source, ICT/ITE/Medical, Efficiency Level: USA DOE Level VI / Eco-design Directive 2009/125/EC, (EU) 2019/1782, Case Color/Style: GlobTek Black, Desktop/External, USB Adaptive Power Supply AC Adaptor, Input Rating: 100-240V~, 50-60Hz, IEC 60320/C8, Output Rating: 60W, 5V, 5.8V, 9V, 12V, 15V, 15.1V, 20VV@4.6A, 4.6A, 4.4A, 4A, 3.6A, 3.6A, 3AA, Output Configuration: mm, / Cond, , Ferrite: , , GT Cord #, Pin Out: +V: A4, A9, B4, B9, GND: A1, A12, B1, B12, CC1: A5, D+:A6, D-:A7, Blades/Input Cord: Not Applicable, Approvals: RCM; CE; PSE; WEEE; VCCI; RoHS; China RoHS; Level VI; Double Insulation; EAC; Ukraine; CB 60601-1 2MOPP (6W max); CB 60950; CB 62368; CCC; ETL 62368; ETL; cETLus 60601-1 3rd; cETLus 60601; RCM; S-Mark 60950; UKCA; Conforms to 62368-1; LPS 60950; Morocco;Morocco; |        |
|   | Model No. GTM96605-G2A1-T2-RA   |        |
|   | Part No./Ordering No. TR9KZ3000USBCRAR6B  | Rev A3 |

**LABEL:L-1624**





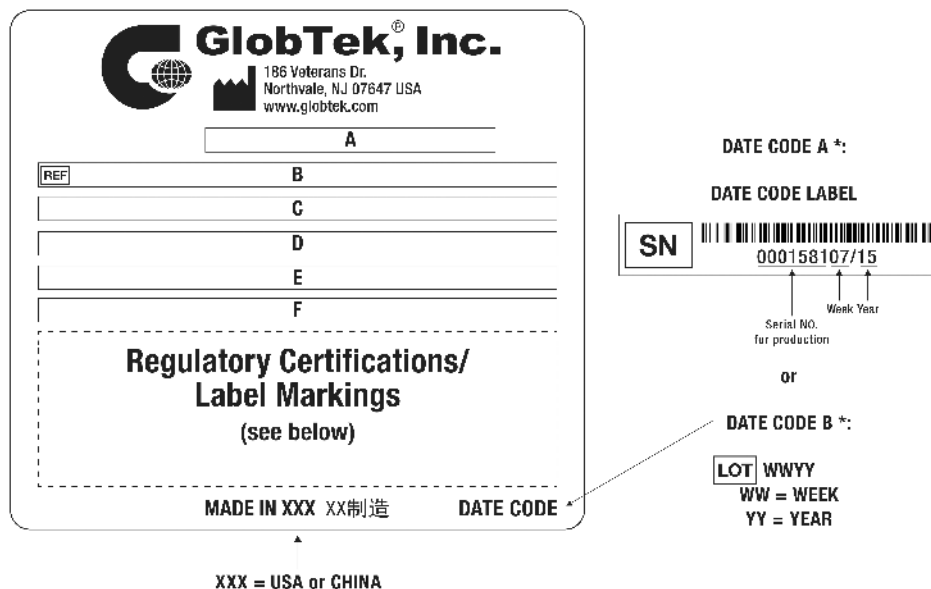

|                                |  |
|--------------------------------|--|
| LABEL P/N                      | ISO 15223 medical device compliant label + FW  |
| MATERIAL                       | Flat Thermal Transfer, Imprintable, Polyester Label and/or Pad Printed and/or Molded, and/or Laser Engraved in the case                    |
| BACKGROUND COLOR               | Black if housing is Black, White or Silver if housing is White or Gray.  |
| TEXT COLOR                     | White or Silver if label is Black Background for Black housing. Black if label is White or Silver background and Housing is White or Gray. |
| SPECIAL BARCODE LABEL MATERIAL | No   |

Below is the minimum information which will appear on the label. NOTE: in the logo area additional/actual positioning of symbols and text is subjected to change as per agency updates/requirements or additional model approvals become available. Agency logos may be in Regulatory Certifications/Label Markings area on the label or molded into the case housing outside the label area. Information will be shown via Label and/or Pad Printed and/or Molded in the case.



A=USB Power Delivery (PD) Source, ICT/ITE/Medical  
 B=P/N: (料号) TR9KZ3000USBCRAR6B  
 C=Model (型号) GTM96605-G2A1-T2-RA  
 D=Input (输入)100-240V~, 50-60Hz, 1.5A

|  |   |        |
|--|---|--------|
| GloTek, Inc.<br>www.globtek.com<br>186 Veterans Drive,<br>Northvale, NJ 07647<br>Tel. (201) 784-1000<br>Fax (201) 784-0111 | Drawing Title: GTM96605-G2A1-T2-RA, USB Power Delivery (PD) Source, ICT/ITE/Medical, Efficiency Level: USA DOE Level VI / Eco-design Directive 2009/125/EC, (EU) 2019/1782, Case Color/Style: GlobTek Black, Desktop/External, USB Adaptive Power Supply AC Adaptor, Input Rating: 100-240V~, 50-60Hz, IEC 60320/C8 , Output Rating: 60W, 5V, 5.8V, 9V, 12V, 15V, 15.1V, 20VV@4.6A, 4.6A, 4.4A, 4A, 3.6A, 3.6A, 3AA, Output Configuration: mm, / Cond, . , Ferrite: . , GT Cord # , Pin Out: +V: A4, A9, B4, B9, GND: A1, A12, B1, B12, CC1: A5, D+:A6, D-:A7, Blades/Input Cord: Not Applicable, Approvals: RCM; CE; PSE; WEEE; VCCI; RoHS; China RoHS; Level VI; Double Insulation; EAC; Ukraine; CB 60601-1 2MOPP (6W max); CB 60950; CB 62368; CCC; ETL 62368; ETL; cETLus 60601-1 3rd; cETLus 60601; RCM; S-Mark 60950; UKCA; Conforms to 62368-1; LPS 60950; Morocco;Morocco; |        |
|  | Model No. GTM96605-G2A1-T2-RA   |        |
|  | Part No./Ordering No. TR9KZ3000USBCRAR6B  | Rev A3 |

|   |
|---|
| E=Output (輸出) 5V  4.6A<br>5.8V  4.6A<br>9V  4.4A<br>12V  4A<br>15V  3.6A<br>15.1V  3.6A<br>20V  3A<br>F=GTF-D336-3 |
|---|

|  |   |        |
|--|---|--------|
| GloTek, Inc.<br>www.globtek.com<br>186 Veterans Drive,<br>Northvale, NJ 07647<br>Tel. (201) 784-1000<br>Fax (201) 784-0111 | Drawing Title: GTM96605-G2A1-T2-RA, USB Power Delivery (PD) Source, ICT/ITE/Medical, Efficiency Level: USA DOE Level VI / Eco-design Directive 2009/125/EC, (EU) 2019/1782, Case Color/Style: GlobTek Black, Desktop/External, USB Adaptive Power Supply AC Adaptor, Input Rating: 100-240V~, 50-60Hz, IEC 60320/C8 , Output Rating: 60W, 5V, 5.8V, 9V, 12V, 15V, 15.1V, 20VV@4.6A, 4.6A, 4.4A, 4A, 3.6A, 3.6A, 3AA, Output Configuration: mm, / Cond, . , Ferrite: . , GT Cord # , Pin Out: +V: A4, A9, B4, B9, GND: A1, A12, B1, B12, CC1: A5, D+:A6, D-:A7, Blades/Input Cord: Not Applicable, Approvals: RCM; CE; PSE; WEEE; VCCI; RoHS; China RoHS; Level VI; Double Insulation; EAC; Ukraine; CB 60601-1 2MOPP (6W max); CB 60950; CB 62368; CCC; ETL 62368; ETL; cETLus 60601-1 3rd; cETLus 60601; RCM; S-Mark 60950; UKCA; Conforms to 62368-1; LPS 60950; Morocco/Morocco; |        |
|  | Model No. GTM96605-G2A1-T2-RA   |        |
|  | Part No./Ordering No. TR9KZ3000USBCRAR6B  | Rev A3 |

|   |   |
|---|---|
| AGENCY ONLINE DOCUMENTS   | <a href="http://www.globtek.info/certs/GTM96605-GEN2/">http://www.globtek.info/certs/GTM96605-GEN2/</a>   |
| CE EC-Declaration for Medical   | <a href="http://globtek.force.com/models/ec_declaration_product?id=01t3a000004vDjK&amp;m=1">http://globtek.force.com/models/ec_declaration_product?id=01t3a000004vDjK&amp;m=1</a>             |
| CE EC-Declaration for Industrial/Commercial/ITE   | <a href="http://globtek.force.com/models/ec_declaration_product?id=01t3a000004vDjK&amp;i=2">http://globtek.force.com/models/ec_declaration_product?id=01t3a000004vDjK&amp;i=2</a>             |
| CE EC-Declaration for Household   | <a href="#">Contact GlobTek for more information</a>  |
| UKCA-Declaration for Medical  | <a href="http://globtek.force.com/models/ukca_declaration_product?id=01t3a000004vDjK&amp;m=1">http://globtek.force.com/models/ukca_declaration_product?id=01t3a000004vDjK&amp;m=1</a>         |
| UKCA-Declaration for Industrial/Commercial/ITE  | <a href="http://globtek.force.com/models/ukca_declaration_product?id=01t3a000004vDjK&amp;i=2">http://globtek.force.com/models/ukca_declaration_product?id=01t3a000004vDjK&amp;i=2</a>         |
| UKCA-Declaration for Household  | <a href="#">Contact GlobTek for more information</a>  |
| Morocco SDoC Declaration  | <a href="https://globtek.secure.force.com/models/Morocco_SDoC_Declaration?id=a000c000000PGI8DEAX">https://globtek.secure.force.com/models/Morocco_SDoC_Declaration?id=a000c000000PGI8DEAX</a> |
| RoHS/RoHS3 Declaration  | <a href="https://www.globtek.com/pdf/rohs_cert/01t3a000004vDjKAAU">https://www.globtek.com/pdf/rohs_cert/01t3a000004vDjKAAU</a>   |
| REACH Declaration   | <a href="https://www.globtek.com/pdf/iso_certificates/REACH.pdf">https://www.globtek.com/pdf/iso_certificates/REACH.pdf</a>   |
| Conflict Minerals Declaration   | <a href="https://www.globtek.com/pdf/conflict-minerals.pdf">https://www.globtek.com/pdf/conflict-minerals.pdf</a>   |
| Prop 65 Statement   | <a href="https://en.globtek.com/prop-65-statement.pdf">https://en.globtek.com/prop-65-statement.pdf</a>   |
| IPXY rating is based on 3rd party testing and customers should check suitability and test system level IPXY rating before ordering. |   |

## Regulatory Certifications/Label Markings

Below follows a link to the latest regulatory certifications and marks for this specific product. National standards as well as certification schemes are constantly changing and so is the set of certification marks and symbols applicable to this product. Various standards, marks and symbols, and certificates are subject to change at any time without notice.

Additional standards or unique country certifications are available upon request. Please contact Globtek to request a quotation.

LATEST PRODUCT/MODEL CERTIFICATIONS: <https://www.globtek.com/datasheet/w70316>

AGENCY ONLINE DOCUMENTS <http://www.globtek.info/certs/GTM96605-GEN2/>



(F1) Class II / Double Insulated

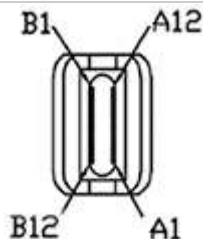

+V: A4, A9, B4, B9,  
GND: A1, A12, B1, B12,  
CC1: A5,  
D+:A6,  
D-:A7



|  |   |        |
|--|---|--------|
| GloTek, Inc.<br>www.globtek.com<br>186 Veterans Drive,<br>Northvale, NJ 07647<br>Tel. (201) 784-1000<br>Fax (201) 784-0111 | Drawing Title: GTM96605-G2A1-T2-RA, USB Power Delivery (PD) Source, ICT/ITE/Medical, Efficiency Level: USA DOE Level VI / Eco-design Directive 2009/125/EC, (EU) 2019/1782, Case Color/Style: GlobTek Black, Desktop/External, USB Adaptive Power Supply AC Adaptor, Input Rating: 100-240V~, 50-60Hz, IEC 60320/C8 , Output Rating: 60W, 5V, 5.8V, 9V, 12V, 15V, 15.1V, 20VV@4.6A, 4.6A, 4.4A, 4A, 3.6A, 3.6A, 3AA, Output Configuration: mm, / Cond, . , Ferrite: . , GT Cord # , Pin Out: +V: A4, A9, B4, B9, GND: A1, A12, B1, B12, CC1: A5, D+:A6, D-:A7, Blades/Input Cord: Not Applicable, Approvals: RCM; CE; PSE; WEEE; VCCI; RoHS; China RoHS; Level VI; Double Insulation; EAC; Ukraine; CB 60601-1 2MOPP (6W max); CB 60950; CB 62368; CCC; ETL 62368; ETL; cETLus 60601-1 3rd; cETLus 60601; RCM; S-Mark 60950; UKCA; Conforms to 62368-1; LPS 60950; Morocco/Morocco; |        |
|  | Model No. GTM96605-G2A1-T2-RA   |        |
|  | Part No./Ordering No. TR9KZ3000USBCRAR6B  | Rev A3 |

## PACKAGING

|                                 |   |
|---------------------------------|---|
| Packing Spec P/N                | Standard DT, Cellular packaging, User manual  |
| Box Qty                         | 75  |
| Gift Box Size (mm)              | Egg Crate   |
| Gift Box Color                  | None  |
| Master Carton Size (mm)         | 455 x 430 x 320   |
| Master Carton Cubic Volume (m³) | 0.06  |
| Master GW (Kg)                  | 7.0 kg  |
| BLADES INCLUDED                 | N/A: Not Applicable   |
| BLADE/CORD INSTALLED            | N/A: Not Applicable   |
| USER MANUAL*                    | 809-DESKTOPUSERMANUAL on A4 paper   |
| USER MANUAL WEB LINK            | <a href="https://en.globtek.com/pdf/809-DESKTOPUSERMANUAL.jpg">https://en.globtek.com/pdf/809-DESKTOPUSERMANUAL.jpg</a> |

\* This specification sheet is considered the user manual for all applications. It is expected that the buyer of this product will use it to formulate their own user manual for their end product and a user manual specifically for the power adapter is not usually required. If a user manual is not specifically listed above then none will be provided with this unit.

If specific packaging is required, this section must specify all requirements and note "no exceptions". If this section does not specify packaging, it is subject to change without notice at GlobTek's discretion.

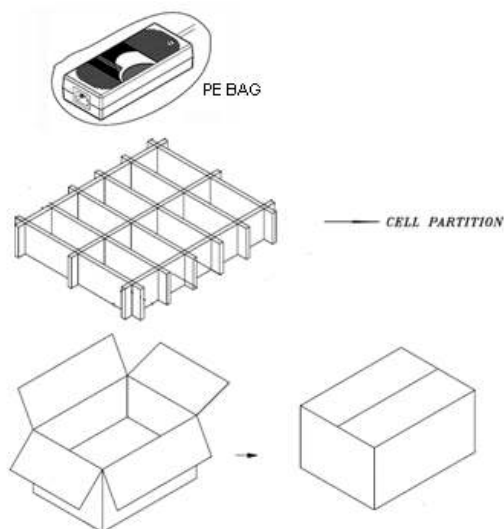

### PROPRIETARY INFORMATION

|   |  |
|---|--|
| <p>GlobTek, Inc.<br/>www.globtek.com<br/>186 Veterans Drive,<br/>Northvale, NJ 07647<br/>Tel. (201) 784-1000<br/>Fax (201) 784-0111</p> | <p>Drawing Title: GTM96605-G2A1-T2-RA, USB Power Delivery (PD) Source, ICT/ITE/Medical, Efficiency Level: USA DOE Level VI / Eco-design Directive 2009/125/EC, (EU) 2019/1782, Case Color/Style: GlobTek Black, Desktop/External, USB Adaptive Power Supply AC Adaptor, Input Rating: 100-240V~, 50-60Hz, IEC 60320/C8 , Output Rating: 60W, 5V, 5.8V, 9V, 12V, 15V, 15.1V, 20VV@4.6A, 4.6A, 4.4A, 4A, 3.6A, 3.6A, 3AA, Output Configuration: mm, / Cond, . , Ferrite: . , GT Cord # , Pin Out: +V: A4, A9, B4, B9, GND: A1, A12, B1, B12, CC1: A5, D+:A6, D-:A7, Blades/Input Cord: Not Applicable, Approvals: RCM; CE; PSE; WEEE; VCCI; RoHS; China RoHS; Level VI; Double Insulation; EAC; Ukraine; CB 60601-1 2MOPP (6W max); CB 60950; CB 62368; CCC; ETL 62368; ETL; cETLus 60601-1 3rd; cETLus 60601; RCM; S-Mark 60950; UKCA; Conforms to 62368-1; LPS 60950; Morocco;Morocco;</p> |
|   | <p>Model No. GTM96605-G2A1-T2-RA</p>   |
|   | <p>Part No./Ordering No. TR9KZ3000USBCRAR6B <span style="float: right;">Rev A3</span></p>  |

**INSTRUCTIONS TO THE OEM SYSTEMS ENGINEER**

It is the responsibility of the OEM systems engineer to provide the end system user instructions and warnings for the use of this product in the end system.

If an input cord is required for this product, AC Mains voltage should be provided to the power supply by a power supply cord approved to the national standards of the country in which it will be used.

This product is not designed to be repaired. No serviceable parts inside. A blown internal fuse is an indication of catastrophic failure of circuit component(s). If a Failure Analysis is required for a failed power supply/battery charger, please return the damaged unit to GlobTek for an accurate determination of the root cause of the failure.

EMC Compliance of the complete OEM product, including the GlobTek power supply/battery charger needs to be verified by the OEM systems engineer.

**INSTRUCTION SHEET**

N/A

|  |  |
|--|--|
| <p>GlobTek, Inc.<br/> www.globtek.com<br/> 186 Veterans Drive,<br/> Northvale, NJ 07647<br/> Tel. (201) 784-1000<br/> Fax (201) 784-0111</p> | <p>Drawing Title: GTM96605-G2A1-T2-RA, USB Power Delivery (PD) Source, ICT/ITE/Medical, Efficiency Level: USA DOE Level VI / Eco-design Directive 2009/125/EC, (EU) 2019/1782, Case Color/Style: GlobTek Black, Desktop/External, USB Adaptive Power Supply AC Adaptor, Input Rating: 100-240V~, 50-60Hz, IEC 60320/C8 , Output Rating: 60W, 5V, 5.8V, 9V, 12V, 15V, 15.1V, 20VV@4.6A, 4.6A, 4.4A, 4A, 3.6A, 3.6A, 3AA, Output Configuration: mm, / Cond, . , Ferrite: . , GT Cord # , Pin Out: +V: A4, A9, B4, B9, GND: A1, A12, B1, B12, CC1: A5, D+:A6, D-:A7, Blades/Input Cord: Not Applicable, Approvals: RCM; CE; PSE; WEEE; VCCI; RoHS; China RoHS; Level VI; Double Insulation; EAC; Ukraine; CB 60601-1 2MOPP (6W max); CB 60950; CB 62368; CCC; ETL 62368; ETL; cETLus 60601-1 3rd; cETLus 60601; RCM; S-Mark 60950; UKCA; Conforms to 62368-1; LPS 60950; Morocco;Morocco;</p> |
|  | <p>Model No. GTM96605-G2A1-T2-RA</p>   |
|  | <p>Part No./Ordering No. TR9KZ3000USBCRAR6B</p>  |
|  | <p>Rev A3</p>  |

