

N-Channel Enhancement Mode Power MOSFET

Description

The G1003A uses advanced trench technology to provide excellent $R_{DS(ON)}$, low gate charge. It can be used in a wide variety of applications.

General Features

- V_{DS} 100V
- I_D (at $V_{GS} = 10V$) 3A
- $R_{DS(ON)}$ (at $V_{GS} = 10V$) < 120m Ω
- $R_{DS(ON)}$ (at $V_{GS} = 4.5V$) < 130m Ω
- 100% Avalanche Tested
- RoHS Compliant
- ESD (HBM)>6KV

Application

- Power switch
- DC/DC converters

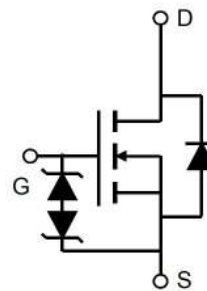

Schematic diagram

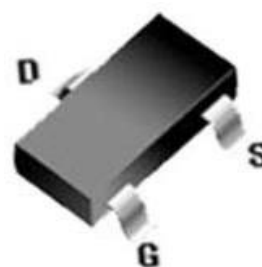

SOT-23-3L

Ordering Information

| Device | Package | Marking | Packaging |
|--------|-----------|---------|--------------|
| G1003A | SOT-23-3L | G1003A | 3000pcs/Reel |

Absolute Maximum Ratings $T_C = 25^\circ\text{C}$, unless otherwise noted

| Parameter | Symbol | Value | Unit |
|--|----------------|------------|------------------|
| Drain-Source Voltage | V_{DS} | 100 | V |
| Continuous Drain Current | I_D | 3 | A |
| Pulsed Drain Current (note1) | I_{DM} | 12 | A |
| Gate-Source Voltage | V_{GS} | ± 20 | V |
| Power Dissipation | P_D | 1.5 | W |
| Operating Junction and Storage Temperature Range | T_J, T_{stg} | -55 To 150 | $^\circ\text{C}$ |

Thermal Resistance

| Parameter | Symbol | Value | Unit |
|---|------------|-------|--------------------|
| Thermal Resistance, Junction-to-Ambient, $t \leq 10s$ (SOP-8 SOT系列) | R_{thJA} | 83.3 | $^\circ\text{C/W}$ |

| Specifications $T_J = 25^\circ\text{C}$, unless otherwise noted | | | | | | |
|--|---------------|--|-------|------|-----------|------------|
| Parameter | Symbol | Test Conditions | Value | | | Unit |
| | | | Min. | Typ. | Max. | |
| Static Parameters | | | | | | |
| Drain-Source Breakdown Voltage | $V_{(BR)DSS}$ | $V_{GS} = 0V, I_D = 250\mu A$ | 100 | -- | -- | V |
| Zero Gate Voltage Drain Current | I_{DSS} | $V_{DS} = 100V, V_{GS} = 0V$ | -- | -- | 1 | μA |
| Gate-Source Leakage | I_{GSS} | $V_{GS} = \pm 20V$ | -- | -- | ± 100 | nA |
| Gate-Source Threshold Voltage | $V_{GS(th)}$ | $V_{DS} = V_{GS}, I_D = 250\mu A$ | 1.0 | 1.7 | 3.0 | V |
| Drain-Source On-Resistance | $R_{DS(on)}$ | $V_{GS} = 10V, I_D = 3A$ | -- | 96 | 120 | m Ω |
| | | $V_{GS} = 4.5V, I_D = 3A$ | -- | 105 | 130 | |
| Forward Transconductance | g_{FS} | $V_{GS} = 5V, I_D = 3A$ | -- | 5 | -- | S |
| Dynamic Parameters | | | | | | |
| Input Capacitance | C_{iss} | $V_{GS} = 0V,$ $V_{DS} = 50V,$ $f = 1.0\text{MHz}$ | -- | 527 | -- | pF |
| Output Capacitance | C_{oss} | | -- | 29 | -- | |
| Reverse Transfer Capacitance | C_{rss} | | -- | 22 | -- | |
| Total Gate Charge | Q_g | $V_{DD} = 50V,$ $I_D = 3A,$ $V_{GS} = 10V$ | -- | 17 | -- | nC |
| Gate-Source Charge | Q_{gs} | | -- | 2 | -- | |
| Gate-Drain Charge | Q_{gd} | | -- | 3 | -- | |
| Turn-on Delay Time | $t_{d(on)}$ | $V_{DD} = 50V,$ $I_D = 3A,$ $R_G = 3\Omega$ | -- | 5 | -- | ns |
| Turn-on Rise Time | t_r | | -- | 4 | -- | |
| Turn-off Delay Time | $t_{d(off)}$ | | -- | 17 | -- | |
| Turn-off Fall Time | t_f | | -- | 4 | -- | |
| Drain-Source Body Diode Characteristics | | | | | | |
| Continuous Body Diode Current | I_S | $T_C = 25^\circ\text{C}$ | -- | -- | 3 | A |
| Body Diode Voltage | V_{SD} | $T_J = 25^\circ\text{C}, I_{SD} = 3A, V_{GS} = 0V$ | -- | -- | 1.2 | V |
| Reverse Recovery Charge | Q_{rr} | $I_F = 3A, V_{GS} = 0V$ $di/dt = 100A/\mu s$ | -- | 12 | -- | nC |
| Reverse Recovery Time | T_{rr} | | -- | 17 | -- | ns |

Notes

1. Repetitive Rating: Pulse width limited by maximum junction temperature
2. Identical low side and high side switch with identical R_G

Gate Charge Test Circuit



Switch Time Test Circuit

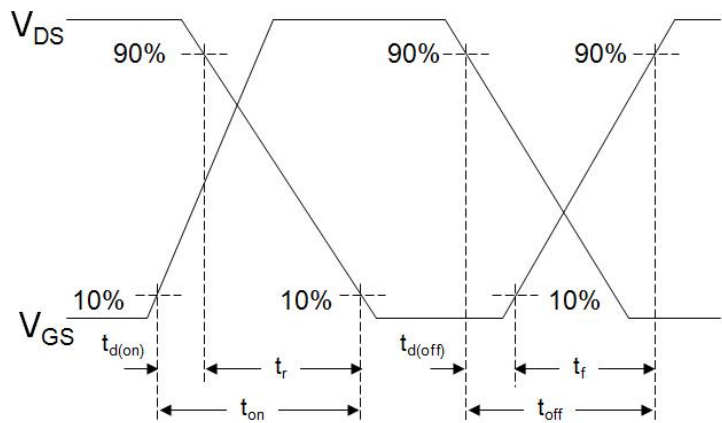
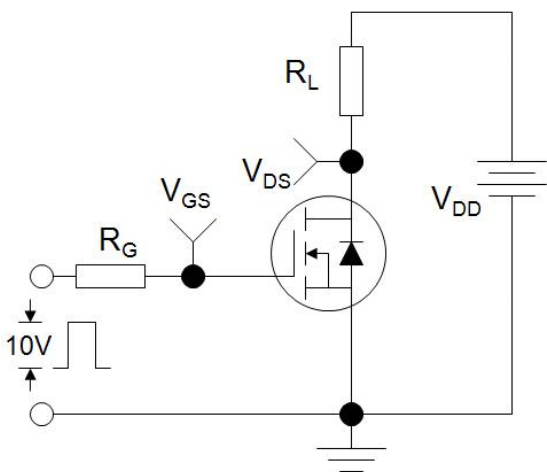

EAS Test Circuit



Typical Characteristics $T_J = 25^\circ\text{C}$, unless otherwise noted

Figure 1. Output Characteristics

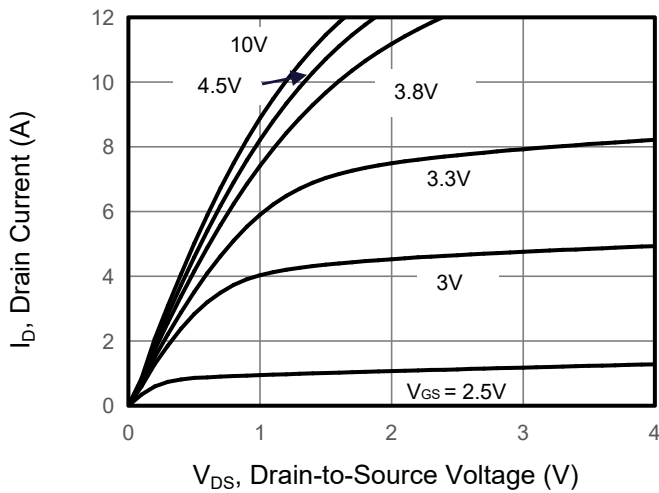

Figure 2. Transfer Characteristics

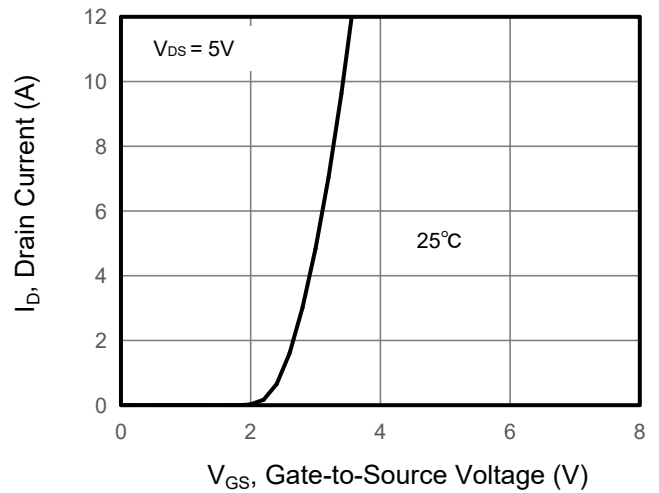

Figure 3. Drain Source On Resistance

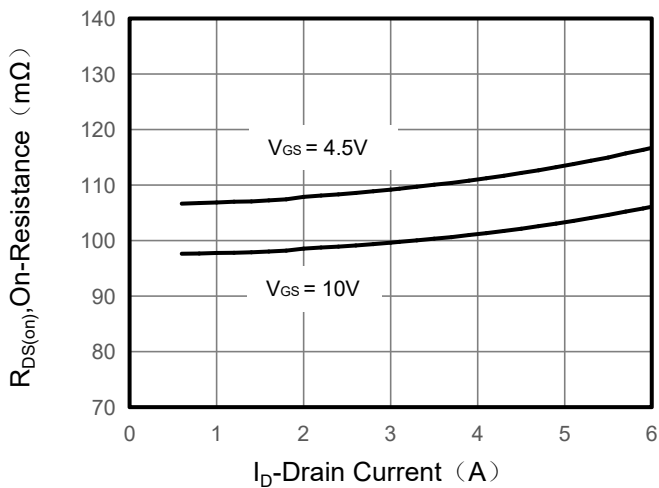

Figure 4. Gate Charge

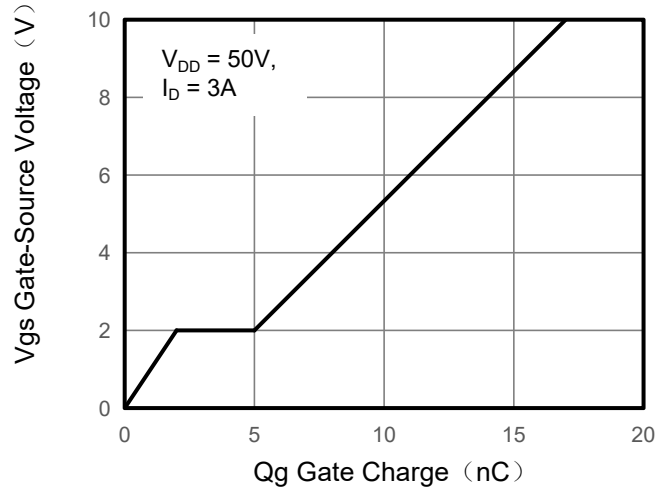

Figure 5. Capacitance

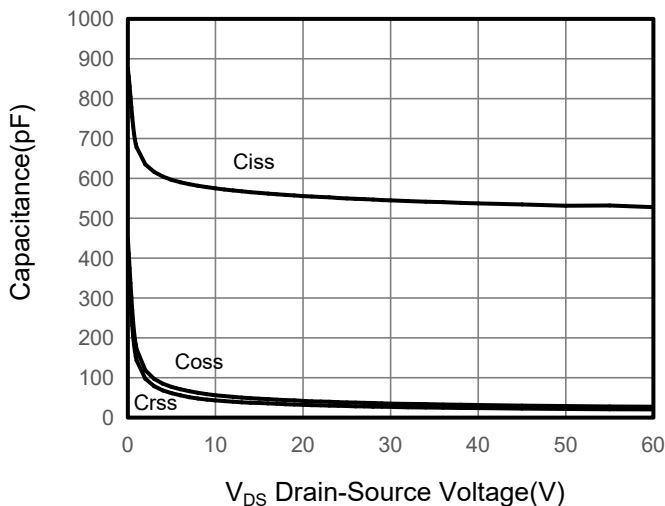
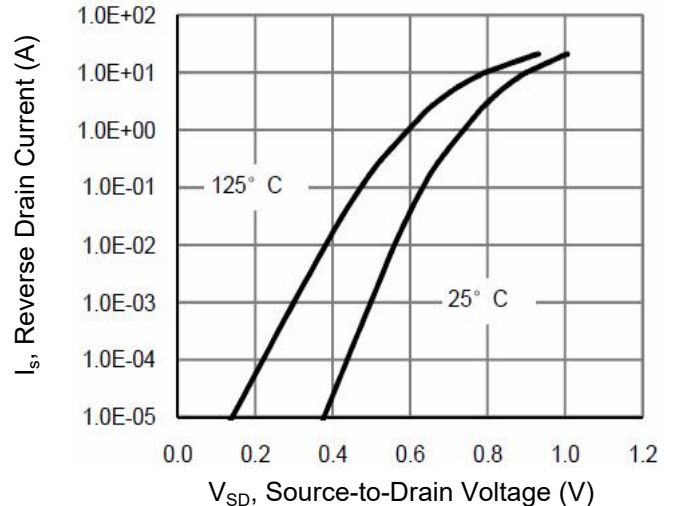

Figure 6. Source-Drain Diode Forward



Typical Characteristics $T_J = 25^\circ\text{C}$, unless otherwise noted

Figure 7. Drain-Source On-Resistance

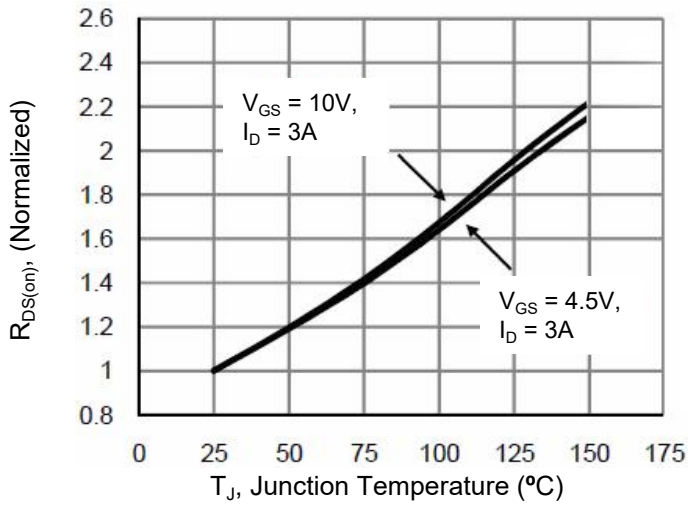

Figure 8. Safe Operation Area

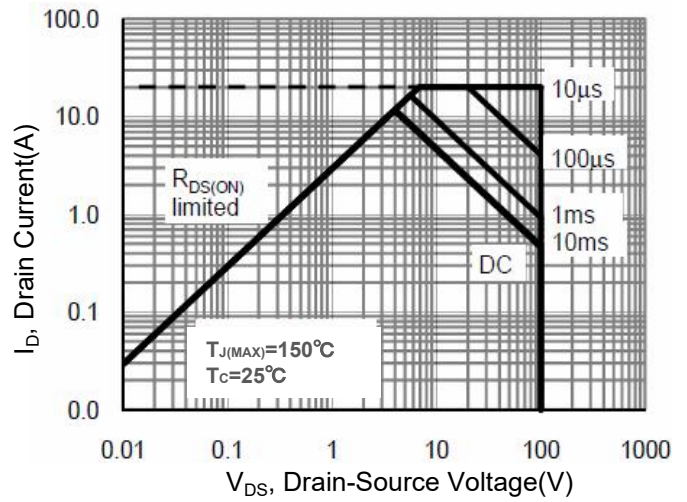
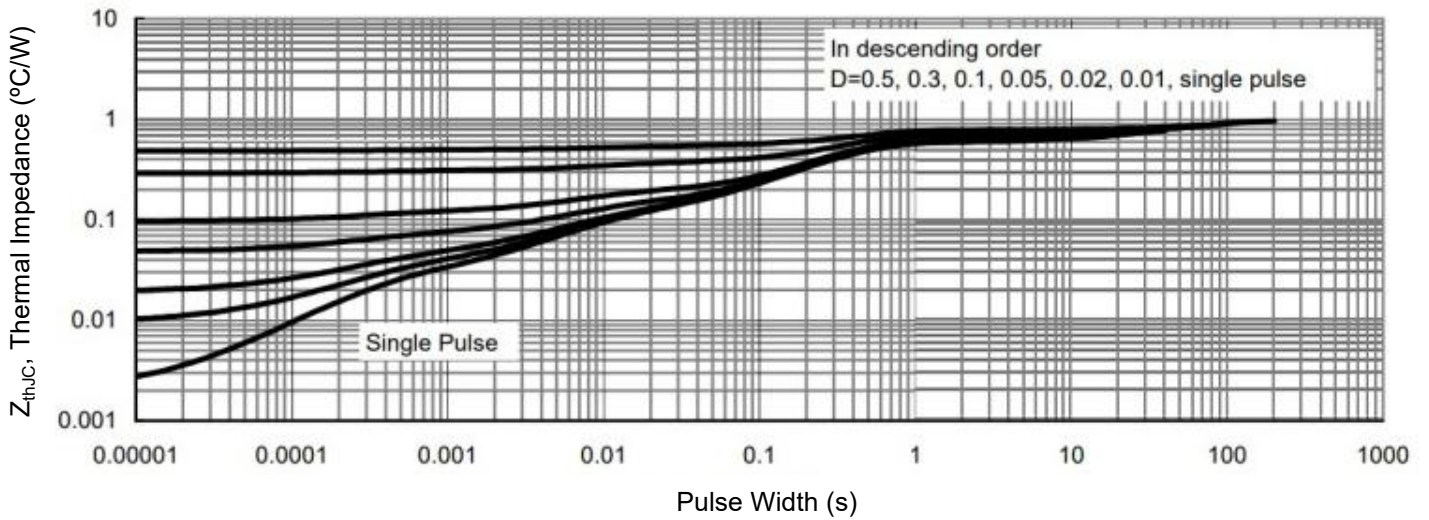
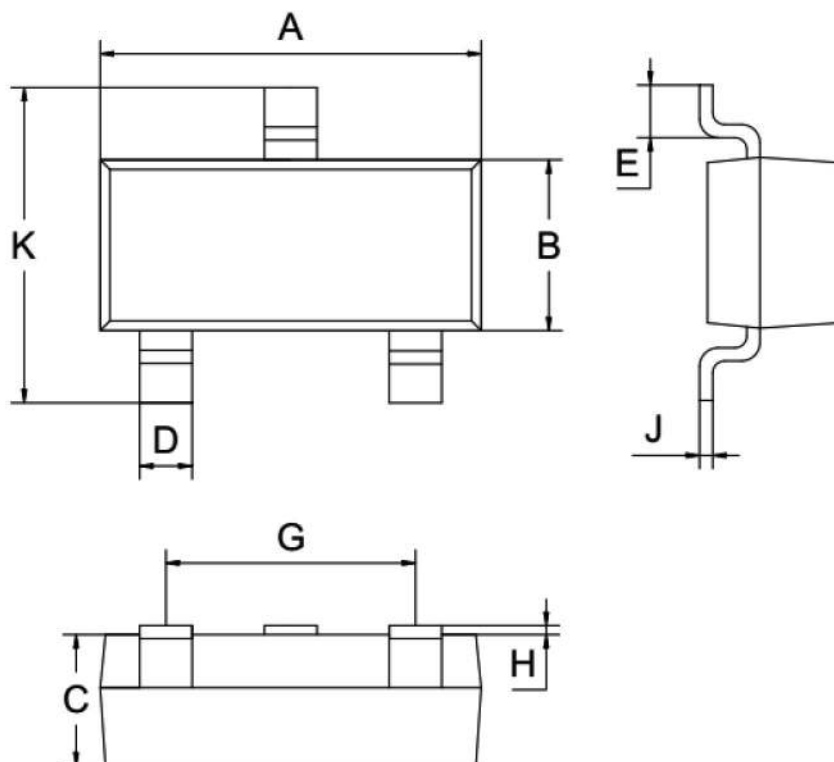

Figure 9. Normalized Maximum Transient Thermal Impedance



SOT-23-3L Package Information



| Symbol | Dimensions in Millimeters | | |
|----------------------|---------------------------|-------|-------|
| | MIN. | NOM. | MAX. |
| A | 2.80 | 2.90 | 3.00 |
| B | 1.50 | 1.60 | 1.70 |
| C | 1.00 | 1.10 | 1.20 |
| D | 0.30 | 0.40 | 0.50 |
| E | 0.25 | 0.40 | 0.55 |
| G | 1.90 | | |
| H | 0.00 | - | 0.10 |
| J | 0.047 | 0.127 | 0.207 |
| K | 2.60 | 2.80 | 3.00 |
| All Dimensions in mm | | | |