

## SMT GaAs MMIC x2 ACTIVE FREQUENCY MULTIPLIER, 27 - 31 GHz OUTPUT

### Typical Applications

The HMC449LC3B is suitable for:

- Point-to-Point & Multi-Point Radios
- VSAT Radios
- Military EW, ECM, C<sup>3</sup>I
- Test Instrumentation
- Military & Space

### Functional Diagram

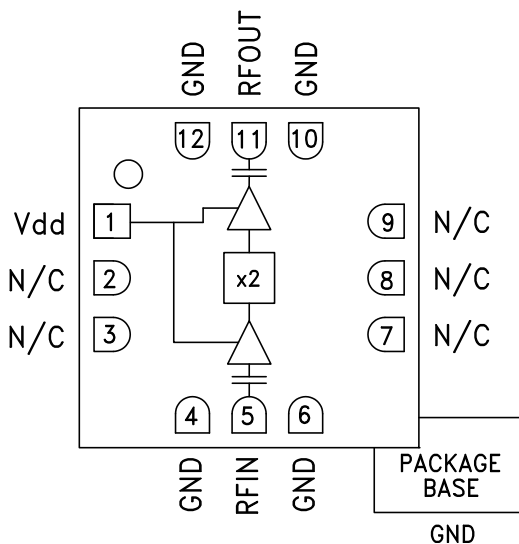

### Features

- Output Power: +9 dBm
- Wide Input Power Range: -4 to +6 dBm
- Fo Isolation: 30 dBc @ Fout= 28 GHz
- 100 kHz SSB Phase Noise: -132 dBc/Hz
- Single Supply: 5V@ 50 mA
- RoHS Compliant 3x3 mm SMT Package

### General Description

The HMC449LC3B is a x2 active broadband frequency multiplier utilizing GaAs PHEMT technology in a leadless RoHS SMT package. When driven by a 0 dBm signal the multiplier provides +9 dBm typical output power from 27 to 31 GHz. The Fo and 3Fo isolations are >25 dBc and >30 dBc respectively at 30 GHz. The HMC449LC3B is ideal for use in LO multiplier chains yielding a reduced parts count vs. traditional approaches. The low additive SSB Phase Noise of -132 dBc/Hz at 100 kHz offset helps maintain good system noise performance. The HMC449LC3B eliminates the need for wire bonding, allowing the use of surface mount manufacturing techniques.

### Electrical Specifications, $T_A = +25^\circ \text{C}$ , $V_{dd} = +5\text{V}$ , 0 dBm Drive Level

Parameter	Min.	Typ.	Max.	Units
Frequency Range, Input		13.5 - 15.5		GHz
Frequency Range, Output		27 - 31		GHz
Output Power	5	9		dBm
Fo Isolation (with respect to output level)		30		dBc
3Fo Isolation (with respect to output level)		25		dBc
Input Return Loss		12		dB
Output Return Loss		8		dB
SSB Phase Noise (100 kHz Offset)		-132		dBc/Hz
Supply Current (I <sub>dd</sub> )		50		mA



## SMT GaAs MMIC x2 ACTIVE FREQUENCY MULTIPLIER, 27 - 31 GHz OUTPUT

**Output Power vs. Temperature @ 0 dBm Drive Level**

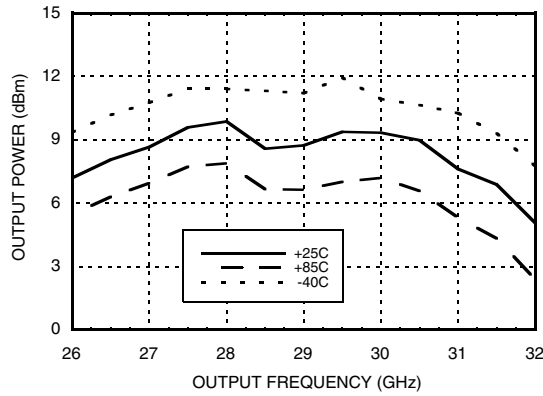

**Output Power vs. Drive Level**

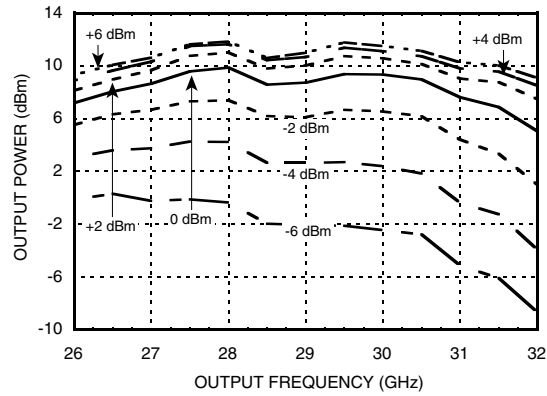

**Output Power vs. Supply Voltage @ 0 dBm Drive Level**

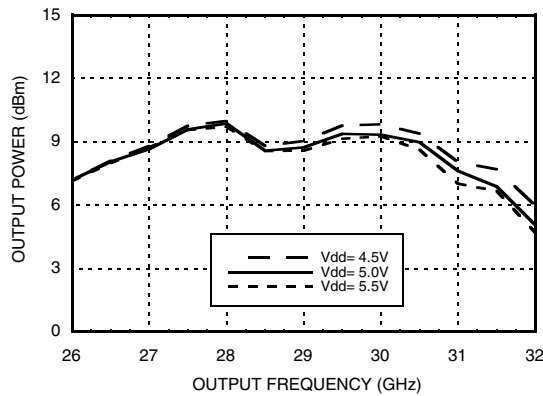

**Isolation @ 0 dBm Drive Level**

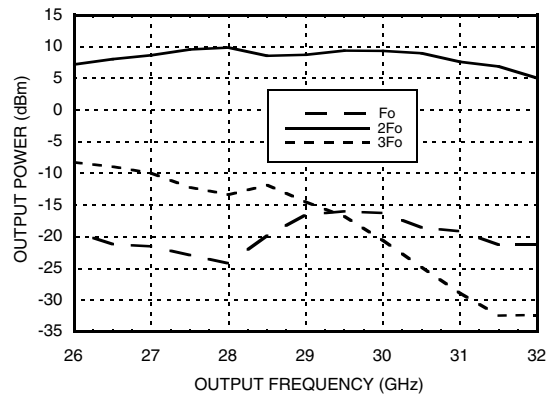

**Pin vs. Pout @ 3 Frequencies**

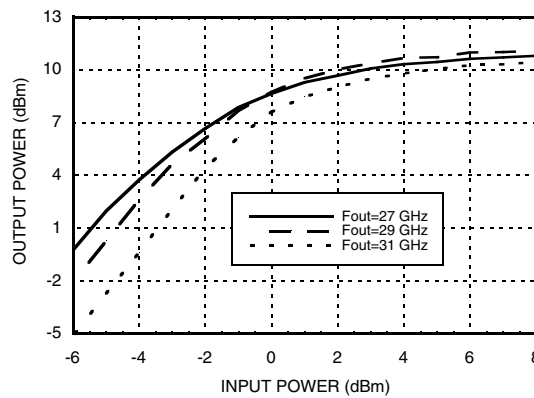



## SMT GaAs MMIC x2 ACTIVE FREQUENCY MULTIPLIER, 27 - 31 GHz OUTPUT

FREQ. MULTIPLIERS - ACTIVE - SMT

**Input Return Loss vs. Temperature**

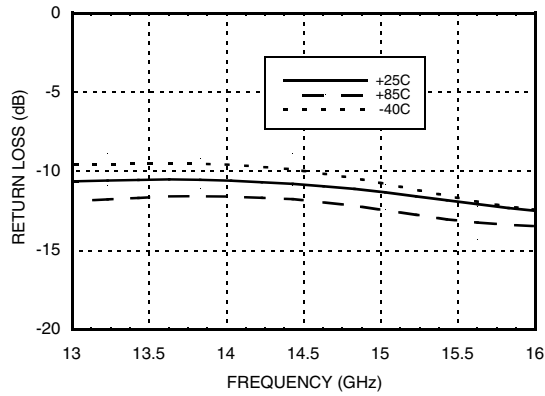

**Output Return Loss vs. Temperature**

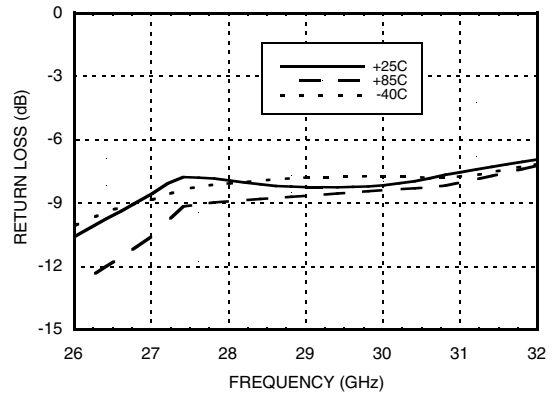

**SSB Phase Noise Performance,  
Fout = 27 GHz, Pin = 0 dBm**

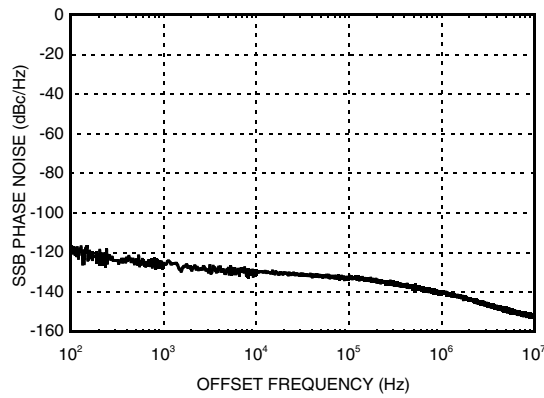

## SMT GaAs MMIC x2 ACTIVE FREQUENCY MULTIPLIER, 27 - 31 GHz OUTPUT

### Absolute Maximum Ratings

RF Input (Vcc= +5V)	+20 dBm
Supply Voltage (Vdd)	+6.0 Vdc
Channel Temperature	175 °C
Continuous Pdiss (T= 85 °C) (derate 8.3 mW/°C above 85 °C)	744 mW
Thermal Resistance (channel to ground paddle)	121 °C/W
Storage Temperature	-65 to +150 °C
Operating Temperature	-40 to +85 °C

### Typical Supply Current vs. Vdd

Vdd (Vdc)	Idd (mA)
4.5	49
5.0	50
5.5	51

Note:  
Multiplier will operate over full voltage range shown above.



ELECTROSTATIC SENSITIVE DEVICE  
OBSERVE HANDLING PRECAUTIONS

### Outline Drawing

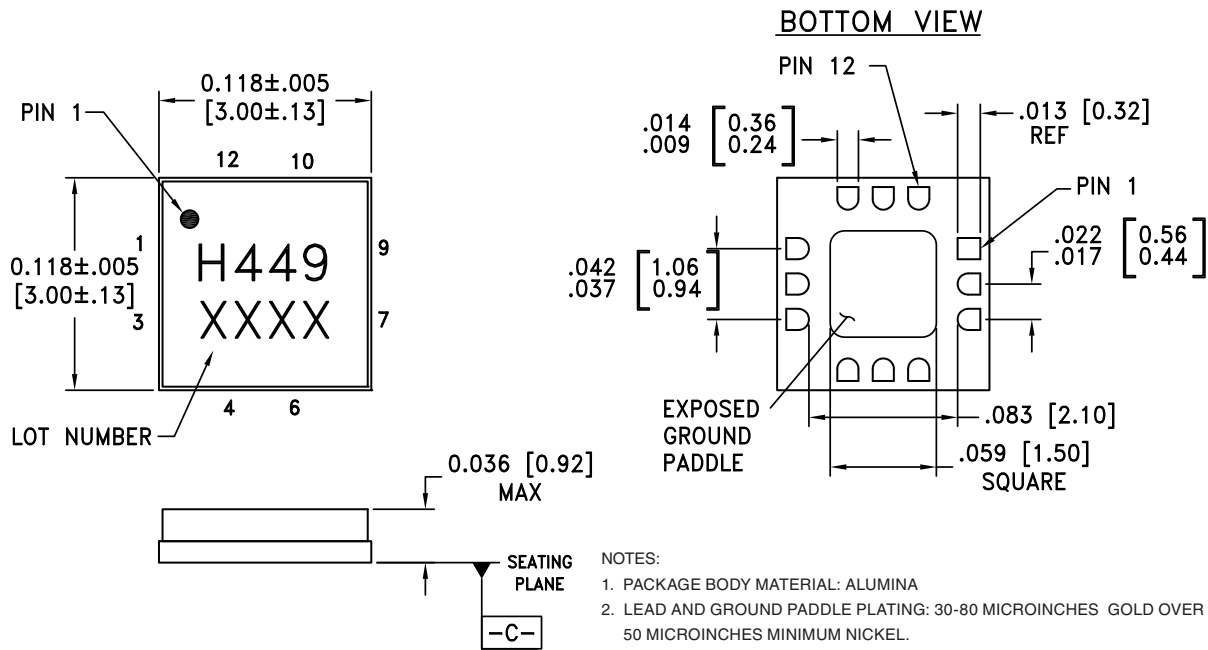

- NOTES:
1. PACKAGE BODY MATERIAL: ALUMINA
  2. LEAD AND GROUND PADDLE PLATING: 30-80 MICROINCHES GOLD OVER 50 MICROINCHES MINIMUM NICKEL.
  3. DIMENSIONS ARE IN INCHES [MILLIMETERS].
  4. LEAD SPACING TOLERANCE IS NON-CUMULATIVE
  5. PACKAGE WARP SHALL NOT EXCEED 0.05mm DATUM [C-]
  6. ALL GROUND LEADS AND GROUND PADDLE MUST BE SOLDERED TO PCB RF GROUND.



### Package Information

Part Number	Package Body Material	Lead Finish	MSL Rating	Package Marking <sup>[2]</sup>
HMC449LC3B	Alumina, White	Gold over Nickel	MSL3 <sup>[1]</sup>	H449 XXXX

[1] Max peak reflow temperature of 260 °C

[2] 4-Digit lot number XXXX

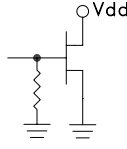
**SMT GaAs MMIC x2 ACTIVE FREQUENCY MULTIPLIER, 27 - 31 GHz OUTPUT**
**Pin Description**

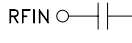
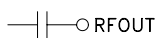
Pin Number	Function	Description	Interface Schematic
1	Vdd	Supply voltage $5V \pm 0.5V$ . External bypass capacitors of 100 pF, 1,000 pF and 2.2 $\mu F$ are required.	
2, 3, 7-9	N/C	This pin may be connected to RF/DC ground. Performance will not be affected.	
4, 6, 10, 12	GND	Package bottom must also be connected to RF/DC ground.	
5	RFIN	Pin is AC coupled and matched to 50 Ohm from 13.5 - 15.5 GHz.	
11	RFOUT	Pin is AC coupled and matched to 50 Ohm from 27 - 31 GHz.	

**Application Circuit**

Component	Value
C1	100 pF
C2	1,000 pF
C3	2.2 $\mu F$

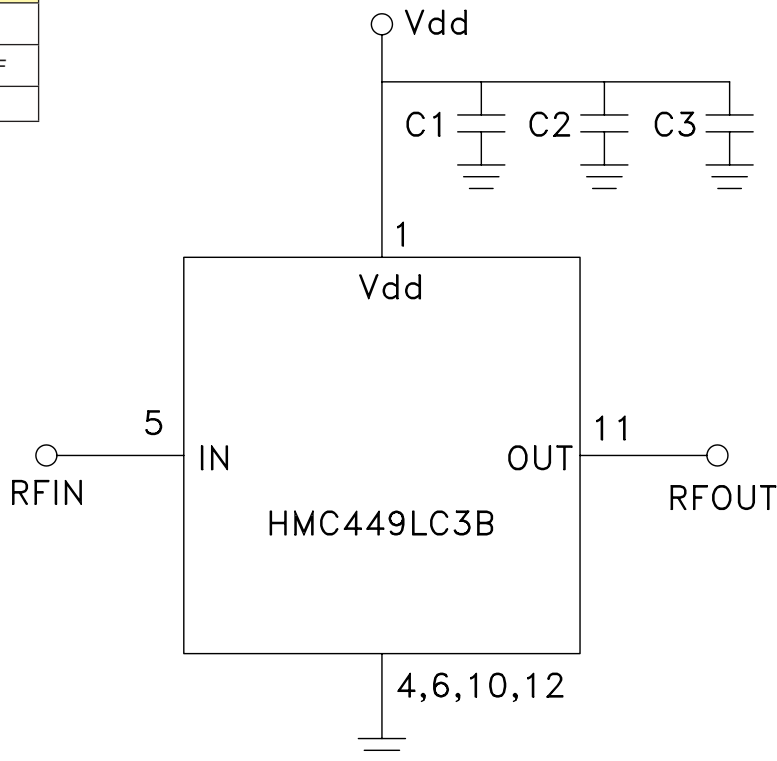



**SMT GaAs MMIC x2 ACTIVE FREQUENCY MULTIPLIER, 27 - 31 GHz OUTPUT**

**Evaluation PCB**

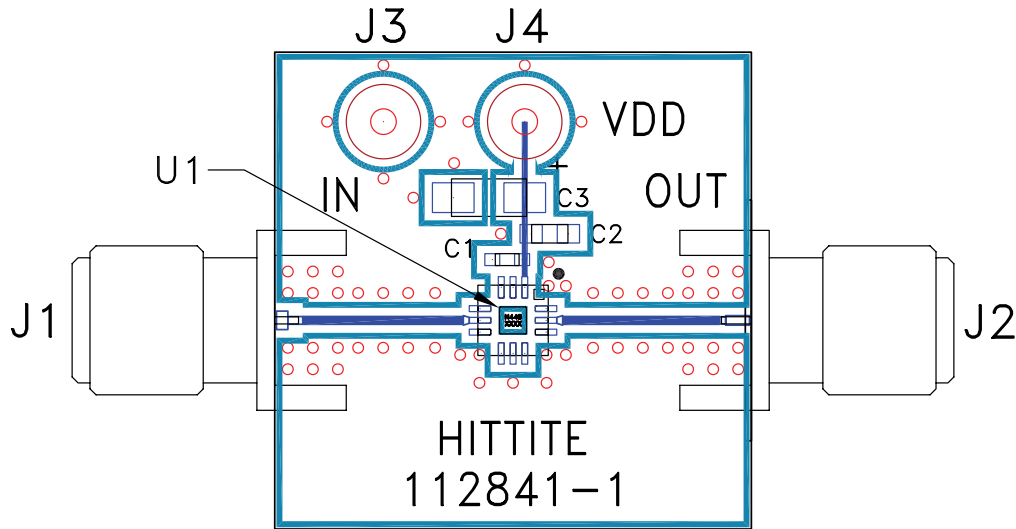

**List of Materials for Evaluation PCB 112697 [1]**

Item	Description
J1	PCB Mount SRI SMA Connector
J2	PCB Mount SRI K Connector
J3 - J4	DC Pin
C1	100 pF Capacitor, 0402 Pkg.
C2	1,000 pF Capacitor, 0603 Pkg.
C3	2.2µF Tantalum Capacitor
U1	HMC449LC3B x2 Active Multiplier
PCB [2]	112841 Eval Board

The circuit board used in the final application should be generated with proper RF circuit design techniques. Signal lines should have 50 ohm impedance while the package ground leads and exposed paddle should be connected directly to the ground plane similar to that shown. The evaluation circuit board shown is available from Hittite upon request.

[1] Reference this number when ordering complete evaluation PCB

[2] Circuit Board Material: Rogers 4350