

## Photo IC type high sensitive light sensor NaPiCa



Through-hole type

**Discontinued products**  
Last time buy : 2017/12/31

### Features

- Built-in optical filter : visibility characteristics close to human visibility
- Linear photocurrent output proportionating to the brightness of surrounding environment
- Environmentally-friendly silicon chip
- RoHS compliant

### Typical Applications

- Automatic lighting of lighting apparatus (domestic lighting, security light)
- Day and night power saving operation of domestic appliances
- Brightness detection of wall clocks (radio clocks)

### Types

Standard packing : Tape and reel package Through-hole type : Carton : 2,000 pcs.; Case: 2,000 pcs.  
Baggage package Through-hole type : Carton : 500 pcs.; Case: 1,000 pcs.

Type (shape)	Photocurrent	Part No.	
		Tape and reel package	Baggage package
Through-hole type	260 $\mu$ A*	AMS302T	AMS302

Note: \*Ev = 100 lx (Ev : Brightness, Fluorescent lamp is used as light source)

### Ratings

- Absolute maximum ratings (Measuring condition: ambient temperature: 25 °C 77 °F)

Item	Symbol	Absolute maximum ratings	Remarks
Reverse voltage	$V_R$	-0.5 V.DC to 8 V.DC	-
Photocurrent	$I_L$	5 mA	-
Power dissipation	P	40 mW	-
Operating temperature	$T_{opr}$	-30 °C to 85 °C -22 °F to +185 °F	Non-condensing at low temperatures
Storage temperature	$T_{stg}$	-40 °C to 100 °C -40 °F to +212 °F	Non-condensing at low temperatures

- Recommended operating condition

Item	Symbol	AMS302	Remarks
Reverse voltage	Minimum	1.5 V.DC	-
	Maximum	6 V.DC	-

- Electrical and optical characteristics (Measuring condition: ambient temperature: 25 °C 77 °F)

Item		Symbol	AMS302	Condition
Peak sensitivity wavelength	—	$\lambda_p$	580 nm	—
Photocurrent 1	Minimum	$I_{L1}$	9.1 $\mu\text{A}$	$V_R=5 \text{ V.DC}, E_v=5 \text{ lx}^{*1}$
	Typical		13 $\mu\text{A}$	
	Maximum		16.9 $\mu\text{A}$	
Photocurrent 2	Minimum	$I_{L2}$	182 $\mu\text{A}$	$V_R=5 \text{ V.DC}, E_v=100 \text{ lx}^{*2}$
	Typical		260 $\mu\text{A}$	
	Maximum		338 $\mu\text{A}$	
Photocurrent 3	Typical	$I_{L3}$	500 $\mu\text{A}$	$V_R=5 \text{ V.DC}, E_v=100 \text{ lx}^{*2}$
Dark current	Maximum	$I_D$	0.3 $\mu\text{A}$	$V_R=5 \text{ V.DC}, E_v=0 \text{ lx}$
Switching time	Rise time	Typical	$t_r$	$V_{CC}=5.0 \text{ V.DC}, V_0=2.5 \text{ V.DC}, R_L=5 \text{ k}\Omega$
	Fall time	Typical	$t_f$	

Note : \*1 Fluorescent lamp is used as light source.  $E_v$  = Brightness  
 \*2 CIE standard illuminant 'A' is used as light source.

[Measuring method for switching time]

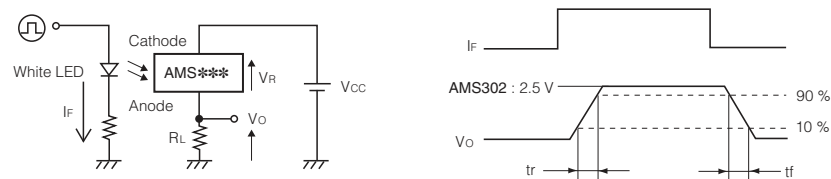

## Reference Data

- Power dissipation vs. ambient temperature characteristics

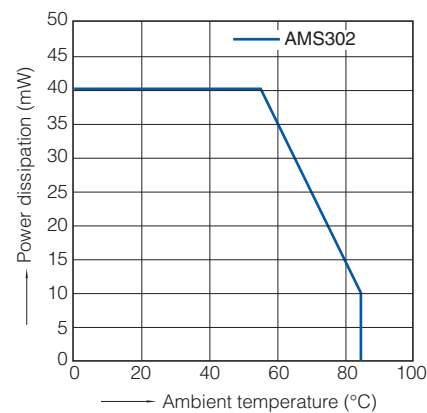

- Relative sensitivity vs. wavelength characteristics

Reverse voltage : 5 V.DC  
 Ambient temperature : 25 °C 77 °F

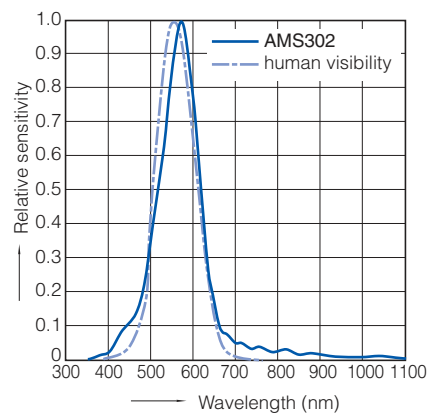

- Dark current vs. ambient temperature characteristics

Reverse voltage : 5 V.DC

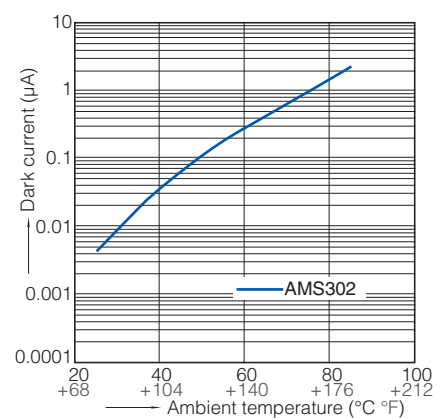

- Photocurrent vs. brightness characteristics

Light source : Fluorescent lamp  
 Reverse voltage : 5 V.DC  
 Ambient temperature : 25 °C 77 °F

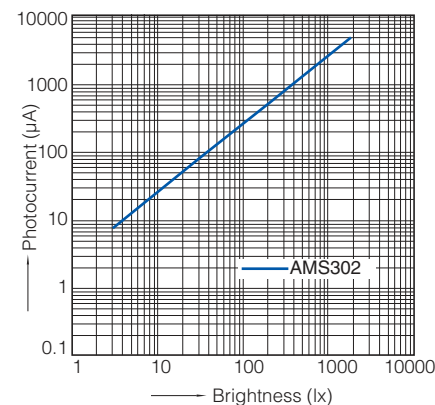

- Relative photocurrent vs. ambient temperature characteristics

Light source : Fluorescent lamp, Brightness : 100 lx  
 Reverse voltage : 5 V.DC

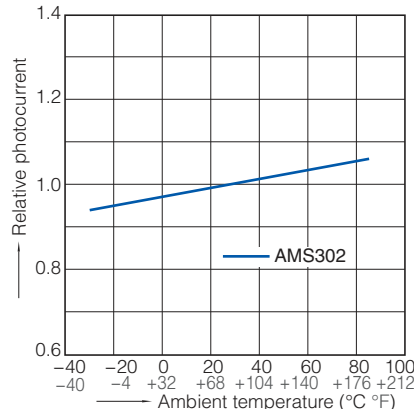

- Relative photocurrent vs. reverse voltage characteristics

Light source : Fluorescent lamp, Brightness : 100 lx  
 Ambient temperature : 25 °C 77 °F

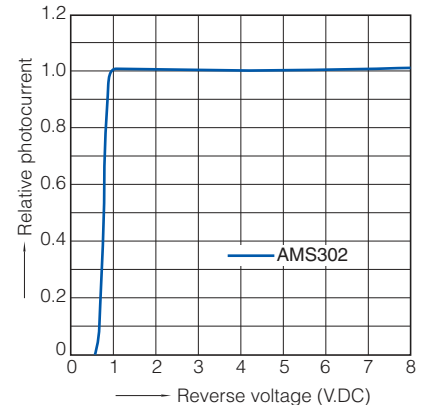

## 7. Switching time vs. resistive load characteristics

Light source : White LED  
 Power voltage : 5 V.DC  
 Resistive load voltage : 2.5 V.DC  
 Ambient temperature : 25 °C 77 °F

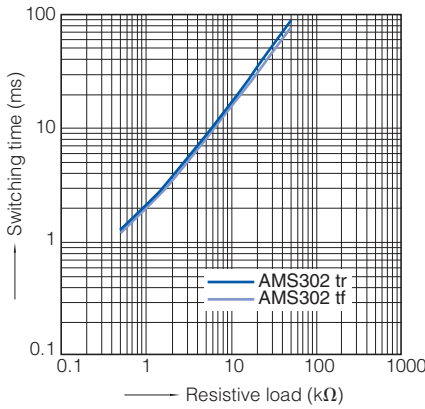

## Dimensions

The CAD data of the products with a **CAD Data** mark can be downloaded from: <http://industrial.panasonic.com/>

### CAD Data

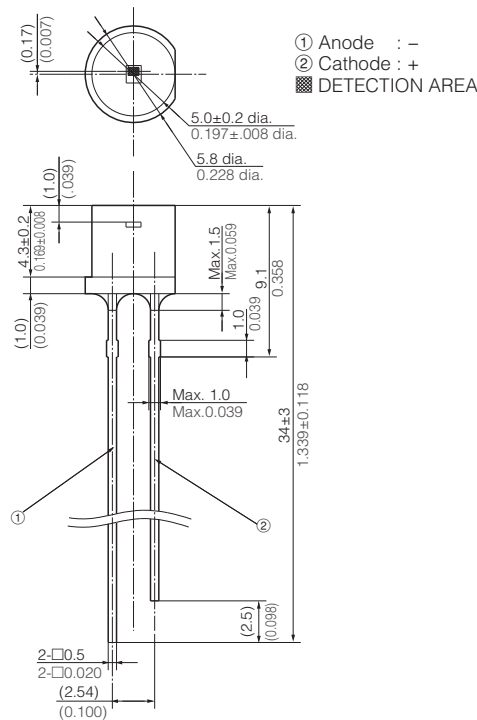
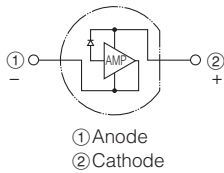
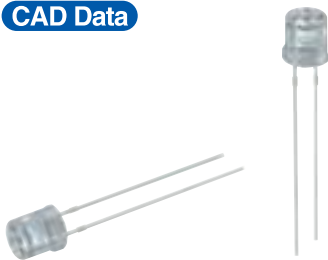

General tolerance :  $\pm 0.5 \pm 0.020$

unit : mm inch

## Safety Precautions

Follow the instructions to prevent injuries and accidents.

- Avoid use beyond the specifications.  
Such use may generate abnormal heat, smoke and fire.

- Correctly connect terminals according to the pin arrangement in the specifications. Misconnection may invite unexpected malfunction, abnormal heat, smoke and fire.
- For safety-sensitive use, arrange appropriate protective circuits and protection devices.

## CAUTIONS FOR USE

### ■ Applying stress beyond absolute maximum rating

When voltage and current values of each terminal exceed absolute maximum rating, overvoltage and overcurrent may deteriorate the internal element. In extreme cases, such excess may melt wires or damage the silicon P/N junction. Design the product not to exceed the absolute maximum rating even momentarily.

### ■ Deterioration and damage by static electricity discharge

The phenomenon, deteriorating the internal element, is generally called electrostatic breakdown. It is caused by discharge of static electricity, arisen from multiple factors, to each terminal. Once unpacked, perform antistatic countermeasures and follow the instructions below.

- 1) Operators must wear antistatic cloths and human body grounding devices, and have the protective resistance of between 500 k $\Omega$  and 1 M $\Omega$ .
- 2) Cover the surface of workbench by electroconductive metal plates and ground measuring instruments and jigs.
- 3) Use the soldering iron which has a small leakage current or ground the soldering tip. (The soldering iron for a low voltage is recommended)
- 4) Ground the assembling equipment.
- 5) When packing printed-circuit boards and devices, avoid polymeric materials, which have electrification characteristics, such as expanded polystyrene and plastic.
- 6) When storing and transporting the sensor, choose the environment where static electricity is hardly generated (e.g., humidity between 45 and 60 %) and protect the product by using electroconductive packaging materials.

### ■ When the power is supplied, the current flowing into the sensor varies in order to stabilize the internal circuit.

### ■ Storage

The sensor is in the transparent resin package. Due to its sensitivity to humidity, the package is moisture-proof. When storing the sensor, follow the instructions below.

- 1) Promptly use after opening. (within a week, below 30 °C 86 °F/60 % R.H.)
- 2) Once unpacked, preserving in a moisture-proof manner, such as keeping in a moisture-proof bag with silica gels, is recommended for long-term storage. (use within 3 months)
- 3) Extremely bad storage conditions may deteriorate solderability or characteristics, and defect the appearance. Recommended conditions of the storage place are below.
  - Temperature : 0 to 30 °C 32 to 86 °F
  - Humidity : Below 60% R.H. (Avoid freezing and dew condensation)
  - Atmosphere: Low-dust and free from noxious chemicals such as sulfurous acid gas

\* During soldering, when adding thermal stress in a moisture absorbing state, moisture evaporates, swells and generates stress to the internal package. To avoid swellings and cracks in the surface of the package, follow soldering conditions below.

### ■ Recommended soldering conditions

<Through-hole type>

#### 1) Recommended conditions

##### (1) Double-wave soldering method

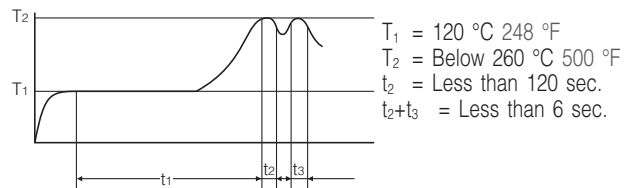

##### (2) Soldering method

Tip temperature : 350 to 400 °C 662 to 752 °F  
 Wattage : 30 to 60 W  
 Soldering time : Less than 3 sec.

- 2) Keep the soldering part at a distance of 3 mm 0.118 inch or more from the root of the lead.

### ■ Mounting

- 1) When various packages are on one circuit board, temperature rise of the lead largely depends on the package size. Keep temperature of the soldered terminals of the products below the previously mentioned specifications. Before use, check the performance with actual equipment.
- 2) If mounting conditions are beyond the specifications above, such use may decrease the resin strength, increase mismatching in the thermal expansion coefficient of each component material, generate cracks in the package and break the bonding wire. Please consult us before use.

### ■ Cleaning

For flux cleaning, immersion cleaning by ASAHIKLIN AK-225 is recommended. If using ultrasonic cleaning for unavoidable reasons, implementation conditions should not be beyond the specifications below. Before use, check and ensure that there is no defect.

- Frequency : 27 to 29 kHz
- Ultrasonic outlet : Below 0.25W/cm<sup>2</sup> \*
- Cleaning time : Less than 30 sec.
- Cleaning solvent : ASAHIKLIN AK-225
- Others : In order to prevent the printedcircuit board and elements from contacting with ultrasonic oscillator, clean the flux while the sensor is suspended in the solution.

\* Ultrasonic outlet per unit area (bottom area) of cleaning tank

### ■ Transportation

Excessive vibration during transport may deform the lead or damage the sensor. Carefully handle the exterior and interior boxes.

### ■ Avoid use in the highly-humid or dusty environment, the corrosive gas, an environment where organic solvent can be adhered.

### ■ Lead-forming and cuttings

- 1) Before soldering, perform lead forming at normal temperature.
- 2) When forming or cutting the lead, keep the spot at a distance of 3 mm 0.118 inch or more from the root of the lead.
- 3) When forming and cutting, fix the root of the lead.
- 4) Avoid mounting which may cause stress on the root of the lead.

- The following shows the packaging format  
Through-hole type tape and reel (mm inch)

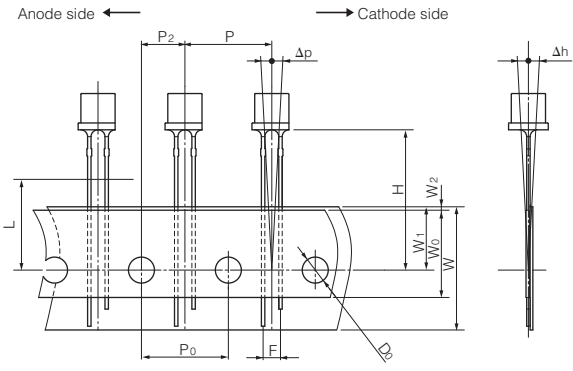
Type	Tape dimensions																																																													
Light sensor NaPiCa Through-hole type AMS302T	 <p>Note : Zigzag tape style is used.</p>	<table border="1"> <thead> <tr> <th>Item</th> <th>Symbol</th> <th>Dimensions</th> <th>Remarks</th> </tr> </thead> <tbody> <tr> <td>Feed hole pitch</td> <td><math>P_0</math></td> <td><math>12.7 \pm 0.3</math> <math>0.500 \pm 0.012</math></td> <td></td> </tr> <tr> <td>Product interval pitch</td> <td><math>P</math></td> <td><math>12.7 \pm 1.0</math> <math>0.500 \pm 0.039</math></td> <td></td> </tr> <tr> <td>Product distance</td> <td><math>P_2</math></td> <td><math>6.35 \pm 1.3</math> <math>0.250 \pm 0.051</math></td> <td></td> </tr> <tr> <td>Product bottom distance</td> <td><math>H</math></td> <td><math>20.5 \pm 1.0</math> <math>0.807 \pm 0.039</math></td> <td></td> </tr> <tr> <td>Lead interval</td> <td><math>F</math></td> <td><math>2.54 \pm 0.5</math> <math>0.100 \pm 0.020</math></td> <td></td> </tr> <tr> <td>Product slant</td> <td><math>\Delta h</math></td> <td><math>0 \pm 1.0</math> <math>0 \pm 0.039</math></td> <td></td> </tr> <tr> <td>Product tilt</td> <td><math>\Delta p</math></td> <td><math>0 \pm 1.0</math> <math>0 \pm 0.039</math></td> <td></td> </tr> <tr> <td>Tape width</td> <td><math>W</math></td> <td><math>18.0^{+1.0}_{-0.5}</math> <math>0.709^{+0.039}_{-0.020}</math></td> <td></td> </tr> <tr> <td>Holding tape width</td> <td><math>W_0</math></td> <td><math>13.0 \pm 0.3</math> <math>0.512 \pm 0.012</math></td> <td></td> </tr> <tr> <td>Feed hole position</td> <td><math>W_1</math></td> <td><math>9.0^{+0.75}_{-0.50}</math> <math>0.354^{+0.030}_{-0.020}</math></td> <td></td> </tr> <tr> <td>Holding tape distance</td> <td><math>W_2</math></td> <td>0 to 0.5 0 to 0.020</td> <td></td> </tr> <tr> <td>Feed hole diameter</td> <td><math>D_0</math></td> <td><math>3.8 \pm 0.2</math> <math>0.150 \pm 0.008</math></td> <td></td> </tr> <tr> <td>Tape thickness</td> <td><math>t</math></td> <td><math>0.5 \pm 0.2</math> <math>0.020 \pm 0.008</math></td> <td>Included holding tape thickness</td> </tr> <tr> <td>Defective product cutoff position</td> <td><math>L</math></td> <td>Max: 11.0 Max: 0.433</td> <td></td> </tr> </tbody> </table>	Item	Symbol	Dimensions	Remarks	Feed hole pitch	$P_0$	$12.7 \pm 0.3$ $0.500 \pm 0.012$		Product interval pitch	$P$	$12.7 \pm 1.0$ $0.500 \pm 0.039$		Product distance	$P_2$	$6.35 \pm 1.3$ $0.250 \pm 0.051$		Product bottom distance	$H$	$20.5 \pm 1.0$ $0.807 \pm 0.039$		Lead interval	$F$	$2.54 \pm 0.5$ $0.100 \pm 0.020$		Product slant	$\Delta h$	$0 \pm 1.0$ $0 \pm 0.039$		Product tilt	$\Delta p$	$0 \pm 1.0$ $0 \pm 0.039$		Tape width	$W$	$18.0^{+1.0}_{-0.5}$ $0.709^{+0.039}_{-0.020}$		Holding tape width	$W_0$	$13.0 \pm 0.3$ $0.512 \pm 0.012$		Feed hole position	$W_1$	$9.0^{+0.75}_{-0.50}$ $0.354^{+0.030}_{-0.020}$		Holding tape distance	$W_2$	0 to 0.5 0 to 0.020		Feed hole diameter	$D_0$	$3.8 \pm 0.2$ $0.150 \pm 0.008$		Tape thickness	$t$	$0.5 \pm 0.2$ $0.020 \pm 0.008$	Included holding tape thickness	Defective product cutoff position	$L$	Max: 11.0 Max: 0.433	
		Item	Symbol	Dimensions	Remarks																																																									
		Feed hole pitch	$P_0$	$12.7 \pm 0.3$ $0.500 \pm 0.012$																																																										
		Product interval pitch	$P$	$12.7 \pm 1.0$ $0.500 \pm 0.039$																																																										
		Product distance	$P_2$	$6.35 \pm 1.3$ $0.250 \pm 0.051$																																																										
		Product bottom distance	$H$	$20.5 \pm 1.0$ $0.807 \pm 0.039$																																																										
		Lead interval	$F$	$2.54 \pm 0.5$ $0.100 \pm 0.020$																																																										
		Product slant	$\Delta h$	$0 \pm 1.0$ $0 \pm 0.039$																																																										
		Product tilt	$\Delta p$	$0 \pm 1.0$ $0 \pm 0.039$																																																										
		Tape width	$W$	$18.0^{+1.0}_{-0.5}$ $0.709^{+0.039}_{-0.020}$																																																										
		Holding tape width	$W_0$	$13.0 \pm 0.3$ $0.512 \pm 0.012$																																																										
		Feed hole position	$W_1$	$9.0^{+0.75}_{-0.50}$ $0.354^{+0.030}_{-0.020}$																																																										
		Holding tape distance	$W_2$	0 to 0.5 0 to 0.020																																																										
		Feed hole diameter	$D_0$	$3.8 \pm 0.2$ $0.150 \pm 0.008$																																																										
Tape thickness	$t$	$0.5 \pm 0.2$ $0.020 \pm 0.008$	Included holding tape thickness																																																											
Defective product cutoff position	$L$	Max: 11.0 Max: 0.433																																																												

## Light Sensor NaPiCa terminology

Term	Symbol	Explanation
Reverse voltage	$V_R$	The applied voltage between the cathode and anode.
Photocurrent	$I_L$	The current that flows between the cathode and anode when light is applied.
Power dissipation	$P$	The electric power loss that occurs between the cathode and anode.
Operating temperature	$T_{opr}$	The workable ambient temperature range at which normal operation is possible under the condition of a prescribed allowable loss.
Storage temperature	$T_{stg}$	The ambient temperature range at which the sensor can be left or stored without applying voltage.
Peak sensitivity wavelength	$\lambda_p$	The wavelength of light at which sensitivity is at its maximum.
Dark current	$I_D$	The current between the cathode and anode when reverse voltage is applied during darkness.
Rise time	$t_r$	Time required for the output waveform to rise from 10 % to 90 % when light is applied.
Fall time	$t_f$	Time required for the output waveform to fall from 90 % to 10 % when light is cut.