



# American Opto Plus LED Corp.

## L152L-LWC-TR

3.2 x 1.6 x 1.1 mm White SMD LED

### PACKAGE DIMENSION

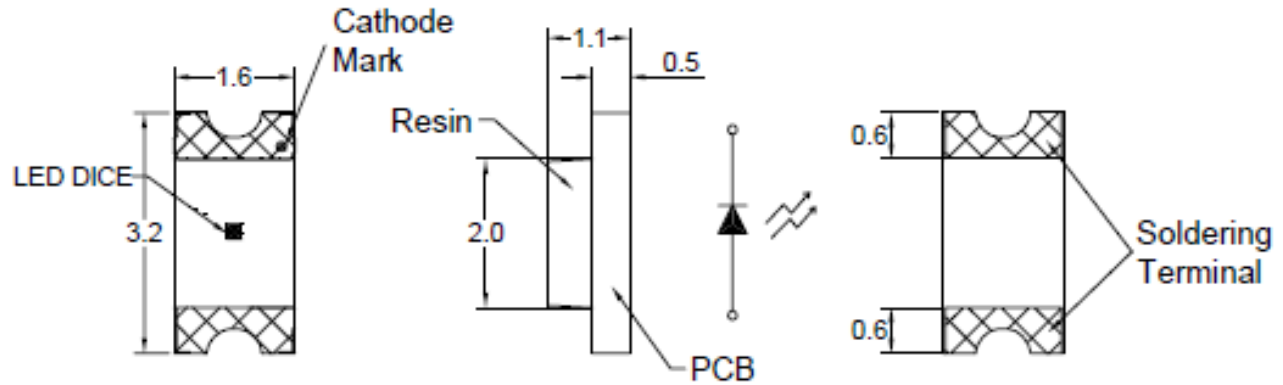

### NOTES:

1. All dimension are in millimeter tolerance is  $\pm 0.1$ mm unless otherwise noted.
2. Specifications are subject to change without notice.

### Recommended Solder Pad

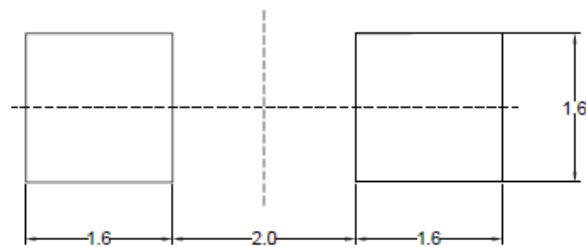

Note : The tolerances unless mentioned is  $\pm 0.1$ mm, Angle  $\pm 0.5$ . Unit=mm.

Chip Material	Chip Emitted	Lens Color	Viewing Angle
InGaN/GaN	White	Yellow Diffused	160



# American Opto Plus LED Corp.

## L152L-LWC-TR

3.2 x 1.6 x 1.1 mm White SMD LED

### ABSOLUTE MAXIMUM RATINGS

(Ta=25°C)

Parameter	Symbol	Value	Unit
Forward current	I <sub>f</sub>	20	mA
Reverse current @ 5V	I <sub>r</sub>	50	μA
Power dissipation	P <sub>d</sub>	80	mW
Operating temperature range	T <sub>opr</sub>	-40~+85	°C
Storage temperature range	T <sub>stg</sub>	-40~+90	°C
Peak pulsing current (1/10 duty f= 10KHz)	I <sub>fp</sub>	100	mA
Soldering Temperature	T <sub>SOL</sub>	Max 260°C for 5 sec Max	

### TYPICAL & OPTICAL-ELECTRICAL CHARACTERISTICS (Ta=25°C)

Parameter	Symbol	Test Condition	Value			Unit
			Min	Typ	Max	
Chromaticity Coordinates	X	I <sub>F</sub> = 20mA	0.21	-	0.35	
	Y	I <sub>F</sub> = 20mA	0.15	-	0.40	
Spectral half bandwidth	Δλ	I <sub>F</sub> = 20mA	-	30	-	nm
Forward Voltage	V <sub>f</sub>	I <sub>F</sub> = 20mA	-	3.5	4.0	V
Luminous intensity	I <sub>v</sub>	I <sub>F</sub> = 20mA	125	320	-	mcd
Viewing angle at 50% I <sub>v</sub>	2θ ½	I <sub>F</sub> = 20mA	-	160		Deg

Note : 1.The forward voltage data did not including ±0.1V testing tolerance.  
 2. The luminous intensity data did not including ±15% testing tolerance.



# American Opto Plus LED Corp.

## L152L-LWC-TR

3.2 x 1.6 x 1.1 mm White SMD LED

### Chromaticity Coordinates Specifications For Bin Grading

BIN	X	Y	BIN	X	Y	BIN	X	Y
A1	0.21	0.190	B1	0.26	0.265	C1	0.31	0.340
	0.21	0.150		0.26	0.225		0.31	0.300
	0.22	0.165		0.27	0.240		0.32	0.315
	0.22	0.205		0.27	0.280		0.32	0.355
A2	0.22	0.205	B2	0.27	0.280	C2	0.32	0.355
	0.22	0.165		0.27	0.240		0.32	0.315
	0.23	0.180		0.28	0.255		0.33	0.330
	0.23	0.220		0.28	0.295		0.33	0.370
A3	0.23	0.220	B3	0.28	0.295	C3	0.33	0.370
	0.23	0.180		0.28	0.255		0.33	0.330
	0.24	0.195		0.29	0.270		0.34	0.345
	0.24	0.235		0.29	0.310		0.34	0.385
A4	0.24	0.235	B4	0.29	0.310	C4	0.34	0.385
	0.24	0.195		0.29	0.270		0.34	0.345
	0.25	0.210		0.30	0.285		0.35	0.360
	0.25	0.250		0.30	0.325		0.35	0.400
A5	0.25	0.250	B5	0.30	0.325			
	0.25	0.210		0.30	0.285			
	0.26	0.225		0.31	0.300			
	0.26	0.265		0.31	0.340			



# American Opto Plus LED Corp.

## L152L-LWC-TR

3.2 x 1.6 x 1.1 mm White SMD LED

### TYPICAL ELECTRO-OPTICAL CHARACTERISTIC CURVES

Fig.1 Forward current vs. Forward Voltage

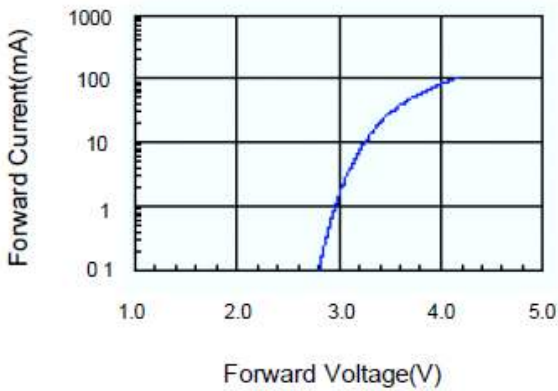

Fig.2 Relative Intensity vs. Forward Current

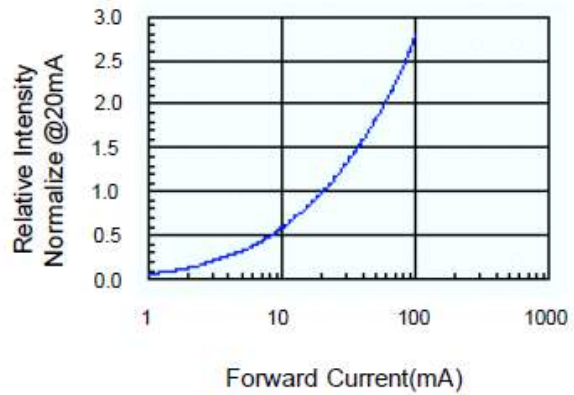

Fig.3 Forward Voltage vs. Temperature

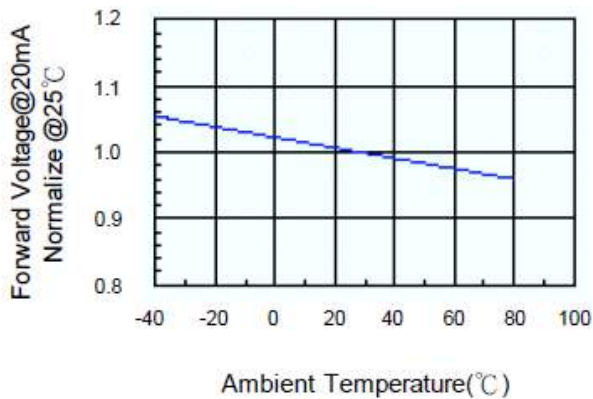

Fig.4 Relative Intensity vs. Temperature

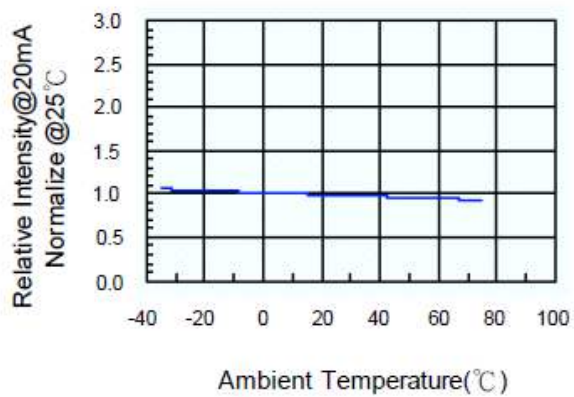

Fig.5 Luminous Spectrum (Ta=25°C)

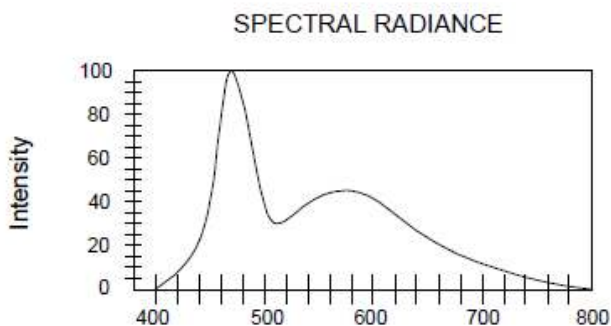
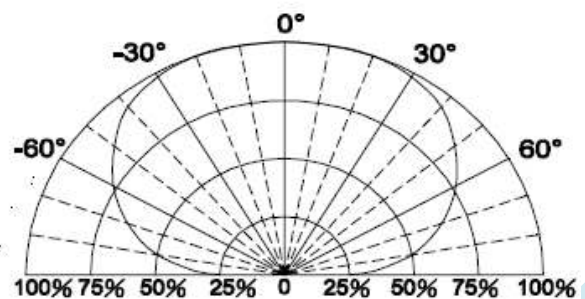

Fig.6 Directive Radiation





# American Opto Plus LED Corp.

## L152L-LWC-TR

3.2 x 1.6 x 1.1 mm White SMD LED

### Dimensions of Tape (Unit: mm)

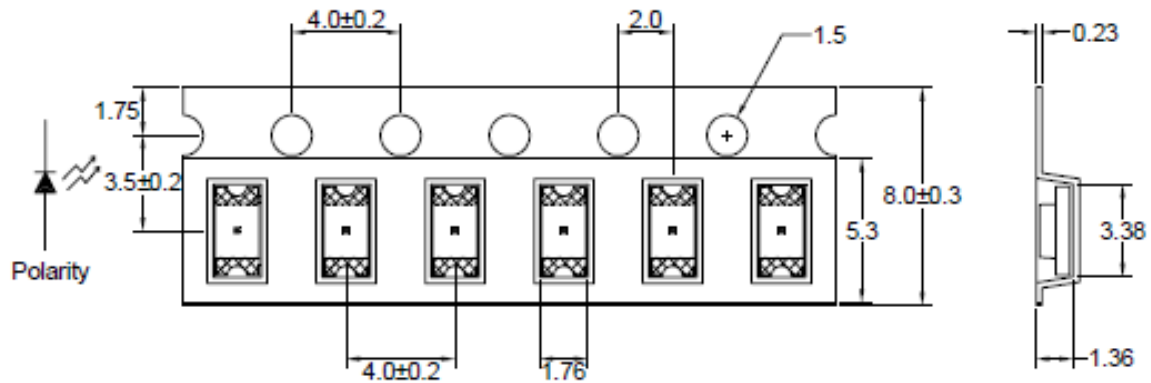

Note : The tolerances unless mentioned is  $\pm 0.1$ mm, Angle  $\pm 0.5$ . Unit=mm.

### PACKAGING SPECIFICATION

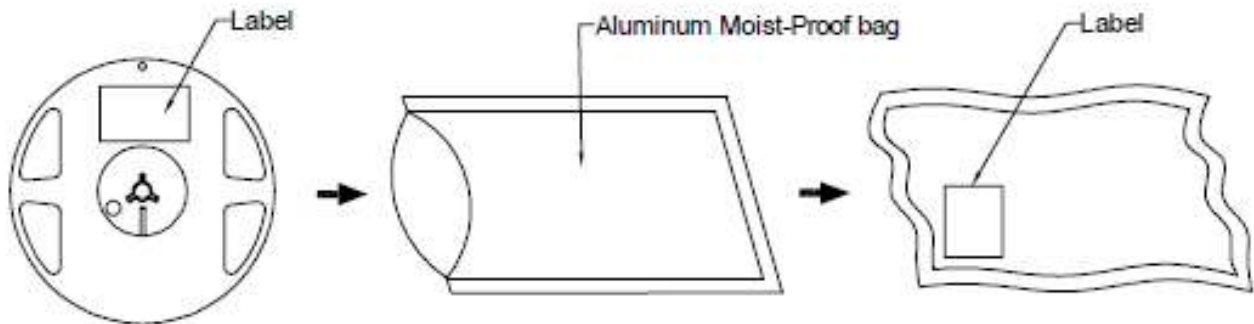



# American Opto Plus LED Corp.

## L152L-LWC-TR

3.2 x 1.6 x 1.1 mm White SMD LED

### REEL DIMENSIONS

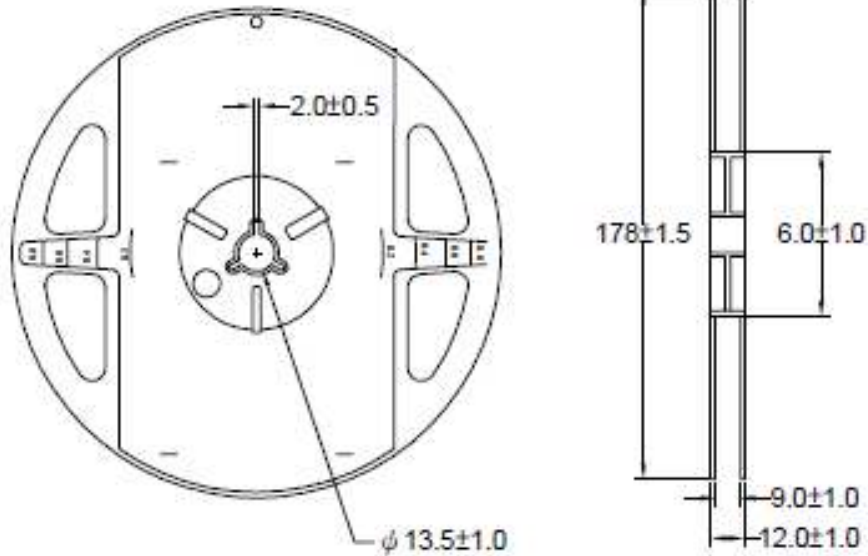

#### Notes:

1. Empty component pockets are sealed with top cover tape;
2. The maximum number of missing lamps is two;
3. The cathode is oriented towards the tape sprocket hole.
4. 3,000pcs/Reel



# American Opto Plus LED Corp.

## L152L-LWC-TR

3.2 x 1.6 x 1.1 mm White SMD LED

### Recommended Soldering Conditions

#### 1. Hand Solder

Basic spec is  $\leq 280^{\circ}\text{C}$  3 sec one time only.

#### 2. Wave Solder

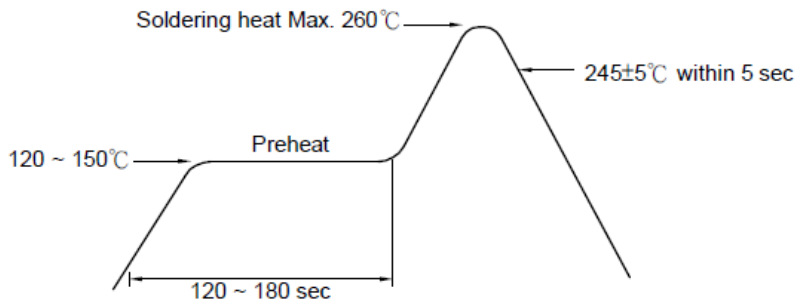

#### 3-1. LEAD Reflow Solder

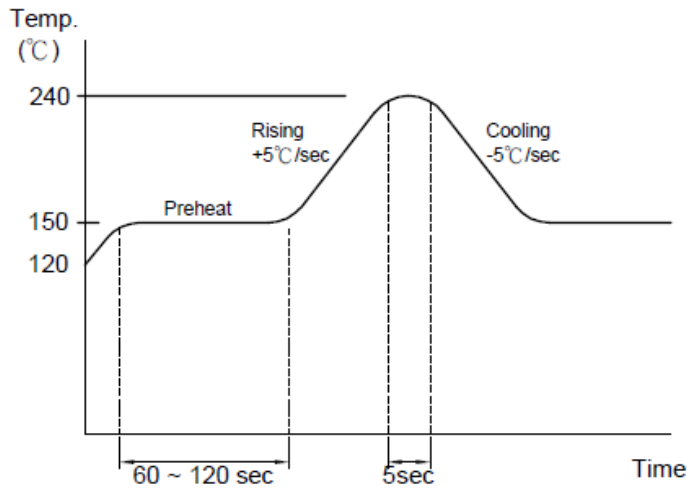

#### 3-2 PB-Free Reflow Solder

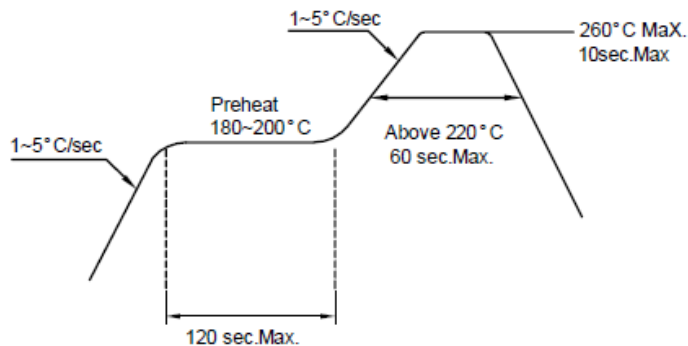

Reflow Soldering should not be done more than two times.



# American Opto Plus LED Corp.

## L152L-LWC-TR

3.2 x 1.6 x 1.1 mm White SMD LED

### Precautions For Use:

#### Storage time:

1. The operation of Temperatures and RH are : 5 °C ~35°C ,RH60%.
2. Once the package is opened, the products should be used within a week. Otherwise, they should be kept in a damp proof box with desiccating agent. Considering the tape life, we suggest our customers to use our products within a year(from production date).
3. If opened more than one week in an atmosphere 5 °C ~ 35°C ,RH60%, they should be treated at 60 °C ±5 °C for 15hrs.

### Drive Method:

LED is a current operated device, and therefore, requires some kind of current limiting incorporated into the driver circuit. This current limiting typically takes the form of a current limiting resistor placed in series with the LED.

Consider worst case voltage variations that could occur across the current limiting resistor. The forward current should not be allowed to change by more than 40 % of its desired value.

Circuit model A



Circuit model B

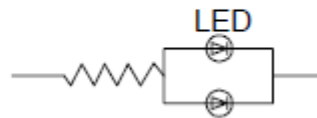

(A) Recommended circuit.

(B) The difference of brightness between LED could be found due to the VF-IF characteristics of LED.

### ESD(Electrostatic Discharge):

Static Electricity or power surge will damage the LED. Use of a conductive wrist band or anti-electrostatic glove is recommended when handling these LED. All devices, equipment and machinery must be properly grounded.





# American Opto Plus LED Corp.

## L152L-LWC-TR

3.2 x 1.6 x 1.1 mm White SMD LED

### RELIABILITY TEST

Classification	Test Item	Test Condition	Reference Standard
Endurance Test	Operating Life Test	1.Ta=Under Room Temperature As Per Data Sheet Maximum Rating. 2.If=20mA 3.t=1000 hrs (-24hrs, +72hrs)	MIL-STD-750D: 1026 MIL-STD-883D: 1005 JIS C 7021: B-1
	High Temperature Storage Test	1.Ta=105°C±5°C 2.t=1000 hrs (-24hrs, +72hrs)	MIL-STD-883D:1008 JIS C 7021: B-10
	Low Temperature Storage Test	1.Ta=-40°C±5°C 2.t=1000 hrs (-24hrs, +72hrs)	JIS C 7021: B-12
	High Temperature High Humidity Storage Test	1.Ta=65°C±5°C 2.RH=90%~95% 3.t=1000hrs±2hrs	MIL-STD-202F:103B JIS C 7021: B-11
Environmental Test	Thermal Shock Test	1.Ta=105°C±5°C & -40°C±5°C (10min) (10min) 2.total 10 cycles	MIL-STD-202F: 107D MIL-STD-750D: 1051 MIL-STD-883D: 1011
	Solderability Test	1.T.Sol=235°C±5°C 2.Immersion time 2±0.5sec 3.Coverage ≥95% of the dipped surface	MIL-STD-202F: 208D MIL-STD-750D: 2026 MIL-STD-883D: 2003 IEC 68 Part 2-20 JIS C 7021: A-2
	Temperature Cycling	1.105°C ~ 25°C ~ -55°C ~ 25°C 30mins 5mins 30mins 5mins 2.10 Cycles	MIL-STD-202F: 107D MIL-STD-750D: 1051 MIL-STD-883D: 1010 JIS C 7021: A-4
	IR Reflow	1.T=260°C Max. 10sec.Max. 2. 6 Min	MIL-STD-750D:2031.2 J-STD-020