

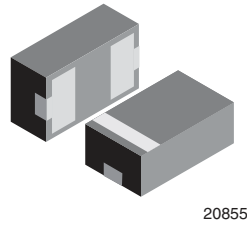

Bidirectional Symmetrical (BiSy) Single Line ESD Protection Diode in LLP1006-2L

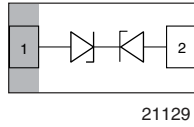

FEATURES

- Ultra compact LLP1006-2L package
- Low package profile < 0.4 mm
- 1-line ESD protection
- Working range ± 7 V
- Low leakage current $I_R < 0.1 \mu A$
- Low load capacitance $C_D = 14$ pF
- ESD immunity acc. IEC 61000-4-2 ± 30 kV contact discharge ± 30 kV air discharge
- Soldering can be checked by standard vision inspection; no X-ray necessary
- Pin plating NiPdAu (e4) no whisker growth
- e4 - precious metal (e.g. Ag, Au, NiPd, NiPdAu) (no Sn)
- PATENT(S): www.vishay.com/patents
- Material categorization: for definitions of compliance please see www.vishay.com/doc?99912



MARKING (example only)



Bar = pin 1 marking
 X = date code
 Y = type code (see table below)

DESIGN SUPPORT TOOLS

[click logo to get started](#)



ORDERING INFORMATION			
DEVICE NAME	ORDERING CODE	TAPED UNITS PER REEL (8 mm TAPE ON 7" REEL)	MINIMUM ORDER QUANTITY
VCUT07B1-HD1	VCUT07B1-HD1-G4-08	8000	8000

PACKAGE DATA						
DEVICE NAME	PACKAGE NAME	TYPE CODE	WEIGHT	MOLDING COMPOUND FLAMMABILITY RATING	MOISTURE SENSITIVITY LEVEL	SOLDERING CONDITIONS
VCUT07B1-HD1	LLP1006-2L	U	0.72 mg	UL 94 V-0	MSL level 1 (according J-STD-020)	Peak temperature max. 260 °C

ABSOLUTE MAXIMUM RATINGS VCUT07B1-HD1				
PARAMETER	TEST CONDITIONS	SYMBOL	VALUE	UNIT
Peak pulse current	Acc. IEC 61000-4-5; $t_p = 8/20 \mu s$; single shot	I_{PPM}	4	A
Peak pulse power	Pin 1 to pin 2 acc. IEC 61000-4-5; $t_p = 8/20 \mu s$; single shot	P_{PP}	60	W
ESD immunity	Contact discharge acc. IEC 61000-4-2; 10 pulses	V_{ESD}	± 30	kV
	Air discharge acc. IEC 61000-4-2; 10 pulses		± 30	kV
Operating temperature	Junction temperature	T_J	-40 to +125	°C
Storage temperature		T_{stg}	-55 to +150	°C

PATENT(S): www.vishay.com/patents

This Vishay product is protected by one or more United States and international patents.

ELECTRICAL CHARACTERISTICS VCUT07B1-HD1 (pin 1 to pin 2 or pin 2 to pin1) ($T_{amb} = 25\text{ }^{\circ}\text{C}$, unless otherwise specified)						
PARAMETER	TEST CONDITIONS/REMARKS	SYMBOL	MIN.	TYP.	MAX.	UNIT
Protection paths	Number of lines which can be protected	$N_{channel}$	-	-	1	lines
Reverse stand-off voltage	Max. reverse working voltage	V_{RWM}	-	-	7	V
Reverse voltage	At $I_R = 0.1\text{ }\mu\text{A}$	V_R	7	-	-	V
Reverse current	At $V_{RWM} = 7\text{ V}$	I_R	-	-	0.1	μA
Reverse breakdown voltage	At $I_R = 1\text{ mA}$	V_{BR}	7.3	-	-	V
Reverse clamping voltage	At $I_{PP} = 1\text{ A}$	V_C	-	9	12	V
	At $I_{PP} = I_{PPM} = 4\text{ A}$		-	-	15	V
Capacitance	At $V_R = 0\text{ V}$; $f = 1\text{ MHz}$	C_D	-	14	16	pF
	At $V_R = 2.5\text{ V}$; $f = 1\text{ MHz}$		-	11	-	pF

CUT THE SPIKES WITH VCUT07B1-HD1:

The VCUT07B1-HD1 is a bidirectional and symmetrical (BiSy) ESD protection device which clamps positive and negative overvoltage transients to ground. Connected between the signal or data line and the ground the VCUT07B1-HD1 offers a high isolation (low leakage current, low capacitance) within the specified working range. Due to the short leads and small package size of the tiny LLP1006-2L package the line inductance is very low, so that fast transients like an ESD strike can be clamped with minimal over- or undershoots.

TYPICAL CHARACTERISTICS ($T_{amb} = 25\text{ }^{\circ}\text{C}$, unless otherwise specified)

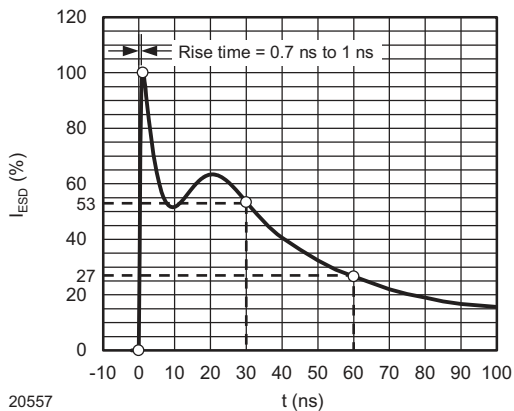

Fig. 1 - ESD Discharge Current Wave Form
acc. IEC 61000-4-2 (330 Ω /150 pF)

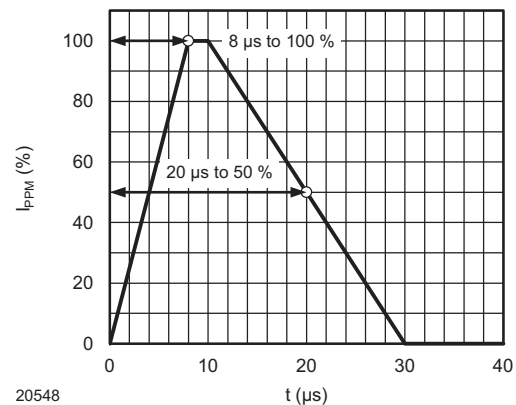

Fig. 2 - 8/20 μs Peak Pulse Current Wave Form
acc. IEC 61000-4-5

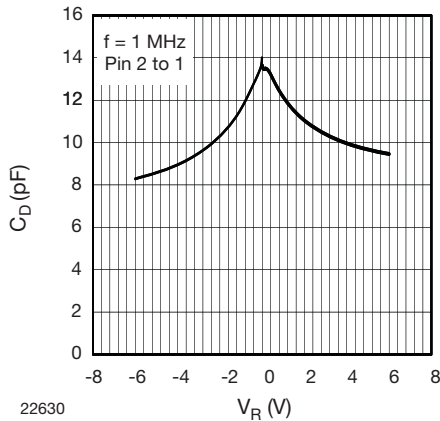

Fig. 3 - Typical Capacitance C_D vs. Reverse Voltage V_R

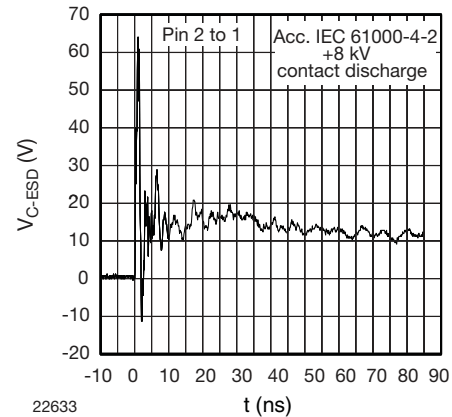

Fig. 6 - Typical Clamping Performance at +8 kV Contact Discharge (acc. IEC 61000-4-2)

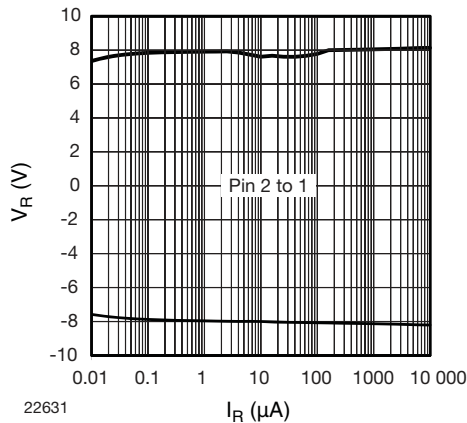

Fig. 4 - Typical Reverse Voltage V_R vs. Reverse Current I_R

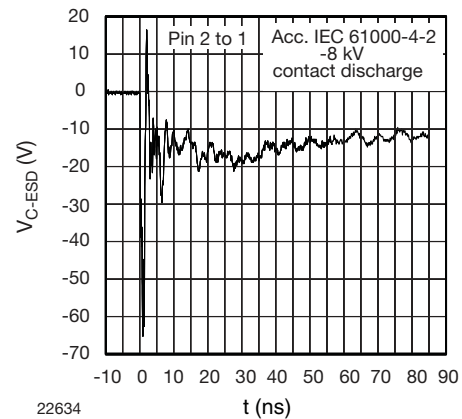

Fig. 7 - Typical Clamping Performance at +8 kV Contact Discharge (acc. IEC 61000-4-2)

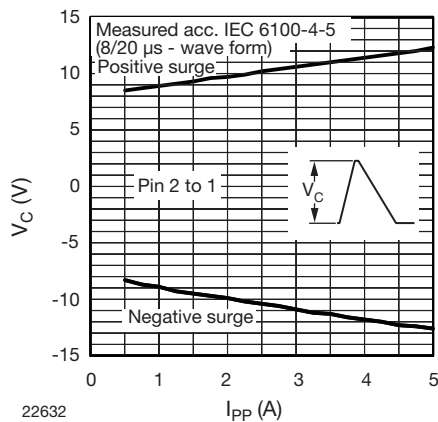

Fig. 5 - Typical Peak Clamping Voltage V_C vs. Peak Pulse Current I_{PP}

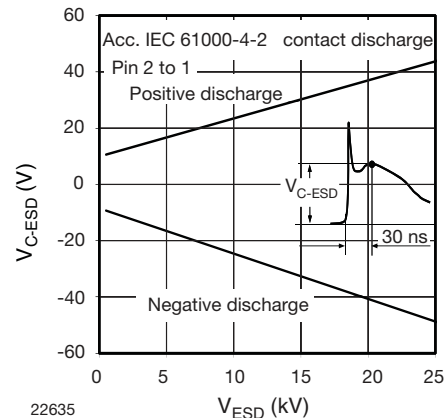
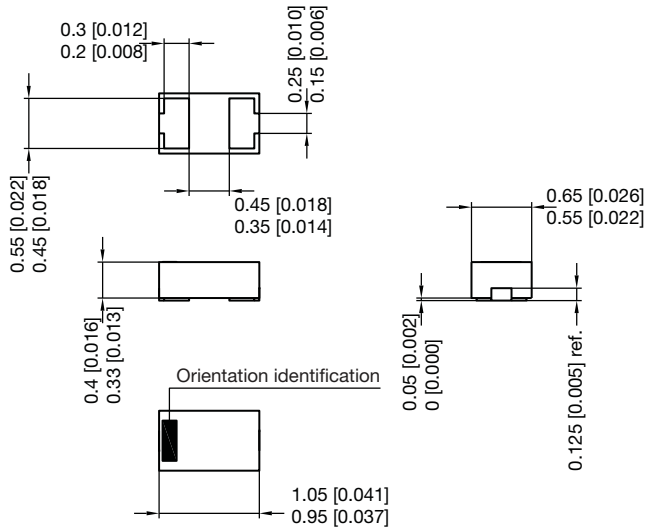

Fig. 8 - Typical Peak Clamping Voltage at ESD Contact Discharge (acc. IEC 61000-4-2)



PACKAGE DIMENSIONS in millimeters (inches): **LLP1006-2L**



Foot print recommendation:

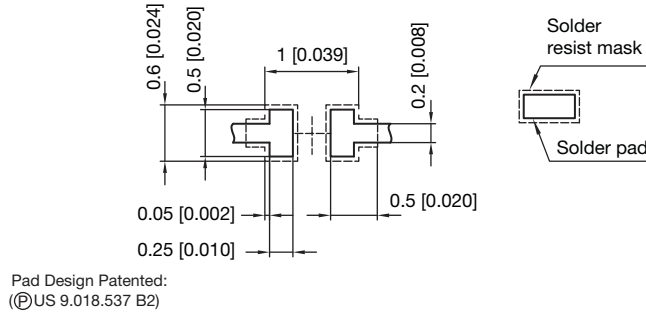

Document no.: S8-V-3906.04-005 (4)
Rev. 7 - Date: 11.May 2016
20812

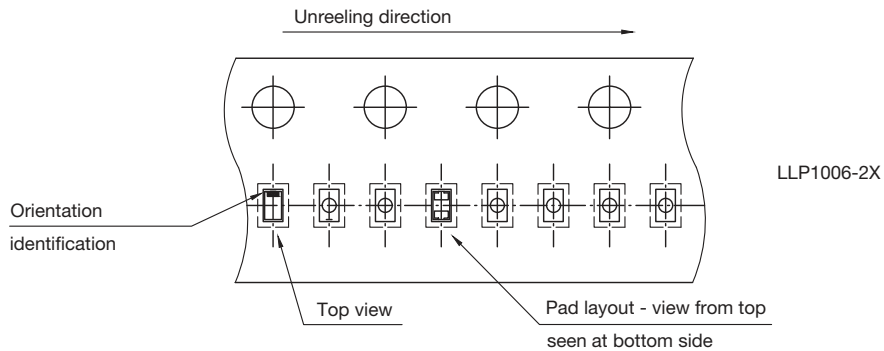

S8-V-3906.04-017 (4)
02.05.2017
22965



Disclaimer

ALL PRODUCT, PRODUCT SPECIFICATIONS AND DATA ARE SUBJECT TO CHANGE WITHOUT NOTICE TO IMPROVE RELIABILITY, FUNCTION OR DESIGN OR OTHERWISE.

Vishay Intertechnology, Inc., its affiliates, agents, and employees, and all persons acting on its or their behalf (collectively, "Vishay"), disclaim any and all liability for any errors, inaccuracies or incompleteness contained in any datasheet or in any other disclosure relating to any product.

Vishay makes no warranty, representation or guarantee regarding the suitability of the products for any particular purpose or the continuing production of any product. To the maximum extent permitted by applicable law, Vishay disclaims (i) any and all liability arising out of the application or use of any product, (ii) any and all liability, including without limitation special, consequential or incidental damages, and (iii) any and all implied warranties, including warranties of fitness for particular purpose, non-infringement and merchantability.

Statements regarding the suitability of products for certain types of applications are based on Vishay's knowledge of typical requirements that are often placed on Vishay products in generic applications. Such statements are not binding statements about the suitability of products for a particular application. It is the customer's responsibility to validate that a particular product with the properties described in the product specification is suitable for use in a particular application. Parameters provided in datasheets and / or specifications may vary in different applications and performance may vary over time. All operating parameters, including typical parameters, must be validated for each customer application by the customer's technical experts. Product specifications do not expand or otherwise modify Vishay's terms and conditions of purchase, including but not limited to the warranty expressed therein.

Hyperlinks included in this datasheet may direct users to third-party websites. These links are provided as a convenience and for informational purposes only. Inclusion of these hyperlinks does not constitute an endorsement or an approval by Vishay of any of the products, services or opinions of the corporation, organization or individual associated with the third-party website. Vishay disclaims any and all liability and bears no responsibility for the accuracy, legality or content of the third-party website or for that of subsequent links.

Except as expressly indicated in writing, Vishay products are not designed for use in medical, life-saving, or life-sustaining applications or for any other application in which the failure of the Vishay product could result in personal injury or death. Customers using or selling Vishay products not expressly indicated for use in such applications do so at their own risk. Please contact authorized Vishay personnel to obtain written terms and conditions regarding products designed for such applications.

No license, express or implied, by estoppel or otherwise, to any intellectual property rights is granted by this document or by any conduct of Vishay. Product names and markings noted herein may be trademarks of their respective owners.