

### FEATURES

- Real time clock keeps track of hundredths of seconds, minutes, hours, days, date of the month, months, and years
- 512K x 8 NV SRAM directly replaces volatile static RAM or EEPROM
- Embedded lithium energy cell maintains calendar operation and retains RAM data
- Watch function is transparent to RAM operation
- Month and year determine the number of days in each month; valid up to 2100
- Over 10 years of data retention in the absence of power
- Full 10% operating range
- Lithium energy source is electrically disconnected to retain freshness until power is applied for the first time
- DIP Module only
  - Standard 32-pin JEDEC pinout
  - Upward comparable with the DS1248
- PowerCap Module Board only
  - Surface mountable package for direct connection to PowerCap
  - Containing battery and crystal
  - Replaceable battery (PowerCap)
  - Pin for pin compatible with other densities of DS124XP Phantom Clocks

### PIN ASSIGNMENT

A18/RST	1	32	V <sub>CC</sub>
A16	2	31	A15
A14	3	30	A17
A12	4	29	WE
A7	5	28	A13
A6	6	27	A8
A5	7	26	A9
A4	8	25	A11
A3	9	24	OE
A2	10	23	A10
A1	11	22	CE
A0	12	21	DQ7
DQ0	13	20	DQ6
DQ1	14	19	DQ5
DQ2	15	18	DQ4
GND	16	17	DQ3

32-Pin Encapsulated Package  
740-Mil Flush

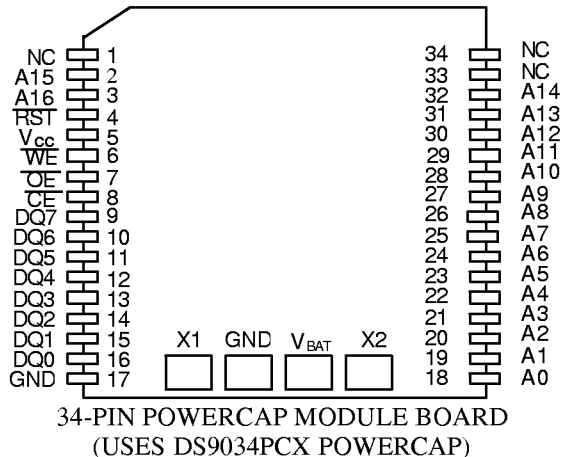

## ORDERING INFORMATION

DS1251YP-XXXX (5 Volt)

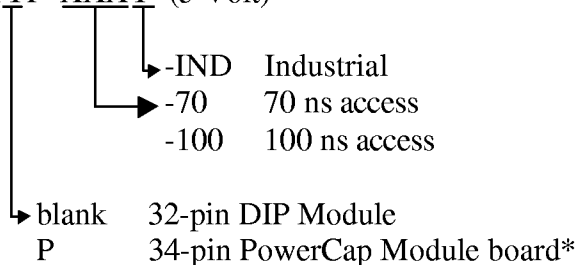

DS1251WP-XXXX (3.3 Volt)

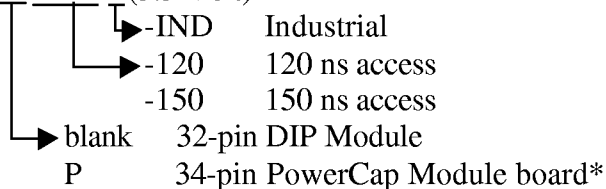

\*DS9034PCX (PowerCap) Required: (must be ordered separately)

## PIN DESCRIPTION

$\overline{A_0-A_{18}}$	- Address Inputs
$\overline{CE}$	- Chip Enable
$\overline{OE}$	- Output Enable
$\overline{WE}$	- Write Enable
$V_{CC}$	- Power Supply Input
GND	- Ground
DQ <sub>0</sub> -DQ <sub>7</sub>	- Data In/Data Out
NC	- No Connection
X1,X2	- Crystal Connection
$\overline{V_{BAT}}$	- Battery Connection
$\overline{RST}$	- Reset

## DESCRIPTION

The DS1251 4096K NV SRAM with Phantom Clock is a fully static nonvolatile RAM (organized as 512K words by 8 bits) with a built-in real time clock. The DS1251Y has a self-contained lithium energy source and control circuitry which constantly monitors  $V_{CC}$  for an out-of-tolerance condition. When such a condition occurs, the lithium energy source is automatically switched on and write protection is unconditionally enabled to prevent garbled data in both the memory and real time clock.

The Phantom Clock provides timekeeping information including hundredths of seconds, seconds, minutes, hours, day, date, month, and year information. The date at the end of the month is automatically adjusted for months with less than 31 days, including correction for leap years. The Phantom Clock operates in either 24-hour or 12-hour format with an AM/PM indicator.

## RAM READ MODE

The DS1251 executes a read cycle whenever  $\overline{WE}$  (Write Enable) is inactive (high) and  $\overline{CE}$  (Chip Enable) is active (low). The unique address specified by the 19 address inputs (A0–A18) defines which of the 512K bytes of data is to be accessed. Valid data will be available to the eight data output drivers within  $t_{ACC}$  (Access Time) after the last address input signal is stable, providing that  $\overline{CE}$  and  $\overline{OE}$  (Output Enable) access times and states are also satisfied. If  $\overline{OE}$  and  $\overline{CE}$  access times are not satisfied, then data access must be measured from the later occurring signal ( $\overline{CE}$  or  $\overline{OE}$ ) and the limiting parameter is either  $t_{CO}$  for  $\overline{CE}$  or  $t_{OE}$  for  $\overline{OE}$  rather than address access.

## PACKAGES

The DS1251 is available in two packages (32-pin DIP and 34-Pin PowerCap module). The 32-pin DIP style module integrates the crystal, lithium energy source, and silicon all in one package. The 34-pin PowerCap Module Board is designed with contacts for connection to a separate PowerCap (DS9034PCX) that contains the crystal and battery. This design allows the PowerCap to be mounted on top of the DS1251P after the completion of the surface mount process. Mounting the PowerCap after the surface mount process prevents damage to the crystal and battery due to the high temperatures required for solder reflow. The PowerCap is keyed to prevent reverse insertion. The PowerCap Module Board and PowerCap are ordered separately and shipped in separate containers. The part number for the Powercap is DS9034PCX.

## RAM READ MODE

The DS1251 executes a read cycle whenever  $\overline{WE}$  (Write Enable) is inactive (high) and  $\overline{CE}$  (Chip Enable) is active (low). The unique address specified by the 19 address inputs (A0–A18) defines which of the 512K bytes of data is to be accessed. Valid data will be available to the eight data output drivers within  $t_{ACC}$  (Access Time) after the last address input signal is stable, providing that  $\overline{CE}$  and  $\overline{OE}$  (Output Enable) access times and states are also satisfied. If  $\overline{OE}$  and  $\overline{CE}$  access times are not satisfied, then data access must be measured from the later occurring signal ( $\overline{CE}$  or  $\overline{OE}$ ) and the limiting parameter is either  $t_{CO}$  for  $\overline{CE}$  or  $t_{OE}$  for  $\overline{OE}$  rather than address access.

## RAM WRITE MODE

The DS1251 is in the write mode whenever the  $\overline{WE}$  and  $\overline{CE}$  signals are in the active (low) state after address inputs are stable. The latter occurring falling edge of  $\overline{CE}$  or  $\overline{WE}$  will determine the start of the write cycle. The write cycle is terminated by the earlier rising edge of  $\overline{CE}$  or  $\overline{WE}$ . All address inputs must be kept valid throughout the write cycle.  $\overline{WE}$  must return to the high state for a minimum recovery time ( $t_{WR}$ ) before another cycle can be initiated. The  $\overline{OE}$  control signal should be kept inactive (high) during write cycles to avoid bus contention. However, if the output bus has been enabled ( $\overline{CE}$  and  $\overline{OE}$  active) then  $\overline{WE}$  will disable the outputs in  $t_{ODW}$  from its falling edge.

## DATA RETENTION MODE

The 5 volt device is fully accessible and data can be written or read only when  $V_{CC}$  is greater than  $V_{PF}$ . However, when  $V_{CC}$  is below the power fail point,  $V_{PF}$ , (point at which write protection occurs) the internal clock registers and SRAM are blocked from any access. When  $V_{CC}$  falls below the battery switch point  $V_{SO}$  (battery supply level), device power is switched from the  $V_{CC}$  pin to the backup battery. RTC operation and SRAM data are maintained from the battery until  $V_{CC}$  is returned to nominal levels. The 3.3 volt device is fully accessible and data can be written or read only when  $V_{CC}$  is greater than  $V_{PF}$ . When  $V_{CC}$  falls below the power fail point,  $V_{PF}$ , access to the device is inhibited. If  $V_{PF}$  is less than  $V_{BAT}$ , the device power is switched from  $V_{CC}$  to the backup supply ( $V_{BAT}$ ) when  $V_{CC}$  drops below  $V_{PF}$ . If  $V_{PF}$  is greater than  $V_{BAT}$ , the device power is switched from  $V_{CC}$  to the backup supply ( $V_{BAT}$ ) when  $V_{CC}$  drops below  $V_{BAT}$ . RTC operation and SRAM data are maintained from the battery until  $V_{CC}$  is returned to nominal levels. All control, data, and address signals must be powered down when  $V_{CC}$  is powered down.

## PHANTOM CLOCK OPERATION

Communication with the Phantom Clock is established by pattern recognition on a serial bit stream of 64 bits which must be matched by executing 64 consecutive write cycles containing the proper data on DQ0. All accesses which occur prior to recognition of the 64-bit pattern are directed to memory.

After recognition is established, the next 64 read or write cycles either extract or update data in the Phantom Clock, and memory access is inhibited.

Data transfer to and from the timekeeping function is accomplished with a serial bit stream under control of Chip Enable ( $\overline{CE}$ ), Output Enable ( $\overline{OE}$ ), and Write Enable ( $\overline{WE}$ ). Initially, a read cycle to any memory location using the  $\overline{CE}$  and  $\overline{OE}$  control of the Phantom Clock starts the pattern recognition sequence by moving a pointer to the first bit of the 64-bit comparison register. Next, 64 consecutive write cycles are executed using the  $\overline{CE}$  and  $\overline{WE}$  control of the SmartWatch. These 64 write cycles are used only to gain access to the Phantom Clock. Therefore, any address to the memory in the socket is acceptable. However, the write cycles generated to gain access to the Phantom Clock are also writing data to a location in the mated RAM. The preferred way to manage this requirement is to set aside just one address location in RAM as a Phantom Clock scratch pad. When the first write cycle is executed, it is compared to bit 0 of the 64-bit comparison register. If a match is found, the pointer increments to the next location of the comparison register and awaits the next write cycle. If a match is not found, the pointer does not advance and all subsequent write cycles are ignored. If a read cycle occurs at any time during pattern recognition, the present sequence is aborted and the comparison register pointer is reset. Pattern recognition continues for a total of 64 write cycles as described above until all the bits in the comparison register have been matched (this bit pattern is shown in Figure 1). With a correct match for 64-bits, the Phantom Clock is enabled and data transfer to or from the timekeeping registers can proceed. The next 64 cycles will cause the Phantom Clock to either receive or transmit data on DQ0, depending on the level of the  $\overline{OE}$  pin or the  $\overline{WE}$  pin. Cycles to other locations outside the memory block can be interleaved with  $\overline{CE}$  cycles without interrupting the pattern recognition sequence or data transfer sequence to the Phantom Clock.

## PHANTOM CLOCK REGISTER INFORMATION

The Phantom Clock information is contained in eight registers of 8 bits, each of which is sequentially accessed 1 bit at a time after the 64-bit pattern recognition sequence has been completed. When updating the Phantom Clock registers, each register must be handled in groups of 8 bits. Writing and reading individual bits within a register could produce erroneous results. These read/write registers are defined in Figure 2.

Data contained in the Phantom Clock register is in binary coded decimal format (BCD). Reading and writing the registers is always accomplished by stepping through all eight registers, starting with bit 0 of register 0 and ending with bit 7 of register 7.

### PHANTOM CLOCK REGISTER DEFINITION Figure 1

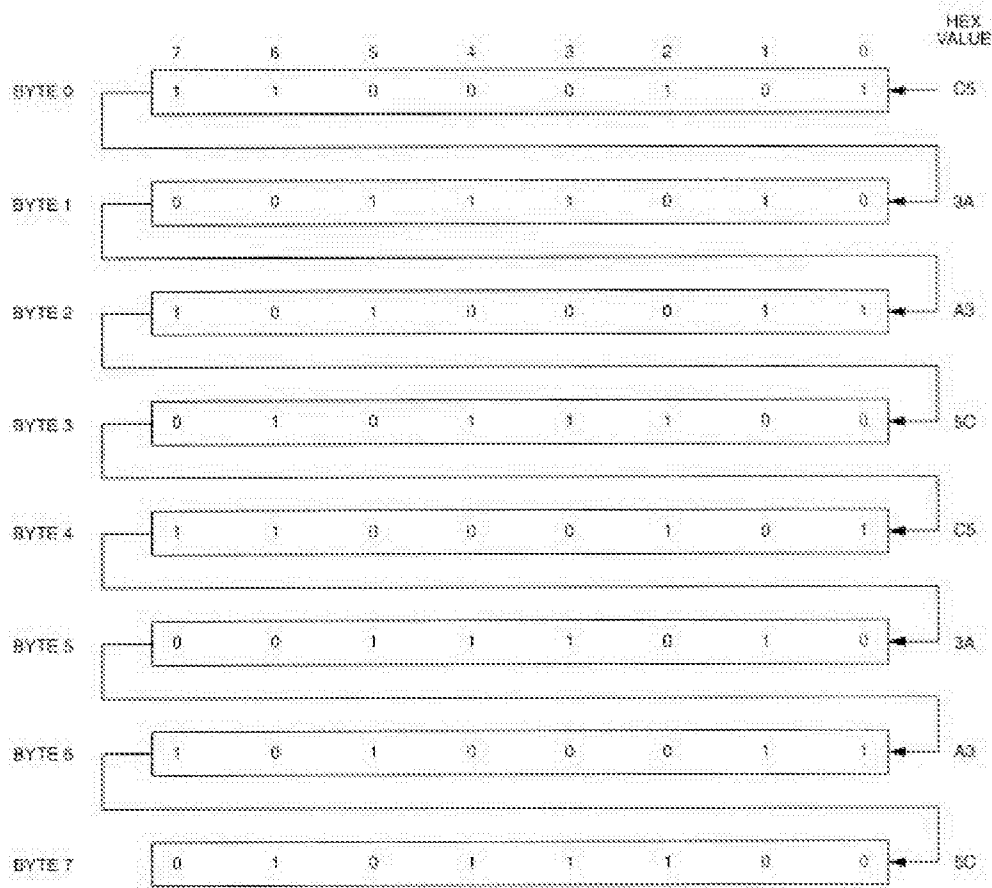

#### NOTE:

The pattern recognition in Hex is C5, 3A, A3, 5C, C5, 3A, A3, 5C. The odds of this pattern being accidentally duplicated and causing inadvertent entry to the Phantom Clock is less than 1 in  $10^{19}$ . This pattern is sent to the Phantom Clock LSB to MSB.

## PHANTOM CLOCK REGISTER DEFINITION Figure 2

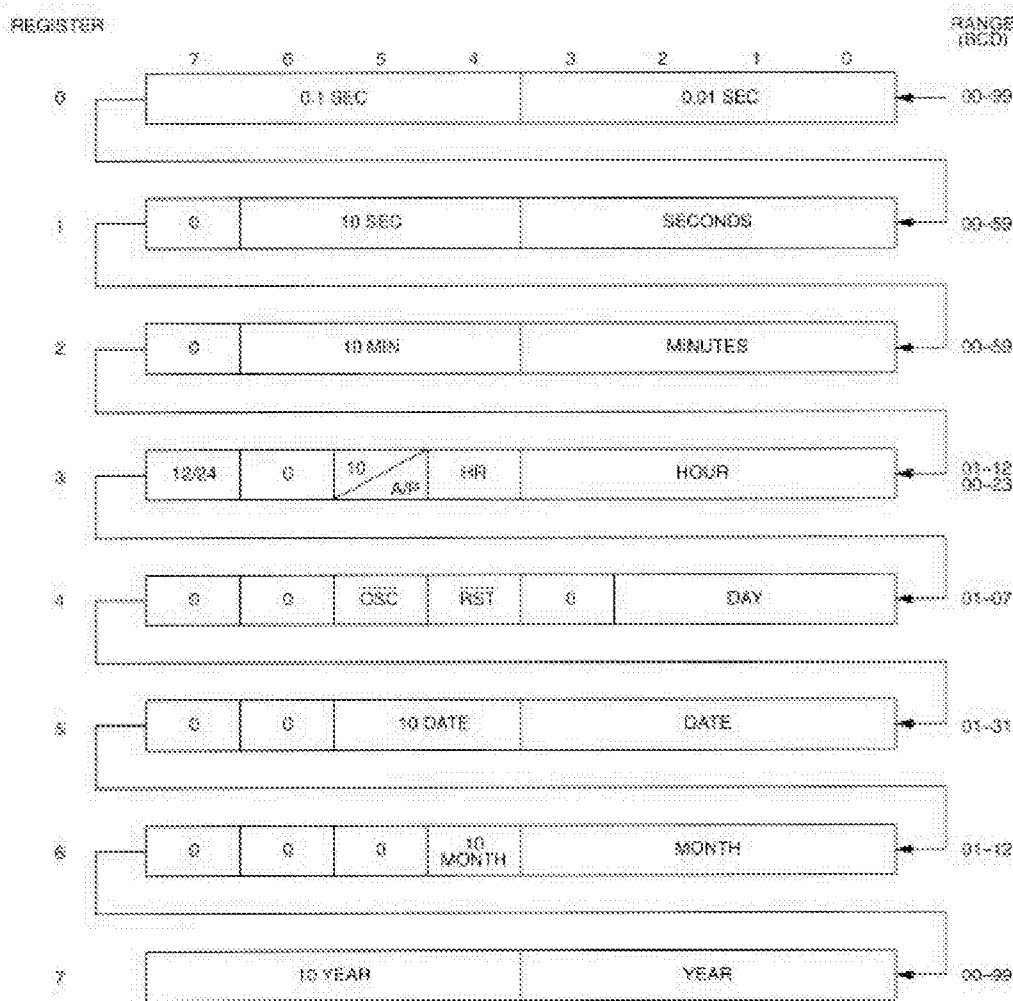

### AM-PM/12/24 MODE

Bit 7 of the hours register is defined as the 12- or 24-hour mode select bit. When high, the 12-hour mode is selected. In the 12-hour mode, bit 5 is the AM/PM bit with logic high being PM. In the 24-hour mode, bit 5 is the second 10-hour bit (20-23 hours).

### OSCILLATOR AND RESET BITS

Bits 4 and 5 of the day register are used to control the RESET and oscillator functions. Bit 4 controls the RESET (pin 1). When the RESET bit is set to logic 1, the RESET input pin is ignored. When the RESET bit is set to logic 0, a low input on the RESET pin will cause the Phantom Clock to abort data transfer without changing data in the watch registers. Bit 5 controls the oscillator. When set to logic 1, the oscillator is off. When set to logic 0, the oscillator turns on and the watch becomes operational. These bits are shipped from the factory set to a logic 1.

### ZERO BITS

Registers 1, 2, 3, 4, 5, and 6 contain one or more bits which will always read logic 0. When writing these locations, either a logic 1 or 0 is acceptable.

## BATTERY LONGEVITY

The DS1251 has a lithium power source that is designed to provide energy for clock activity, and clock and RAM data retention when the  $V_{CC}$  supply is not present. The capability of this internal power supply is sufficient to power the DS1251 continuously for the life of the equipment in which it is installed. For specification purposes, the life expectancy is 10 years at 25°C with the internal clock oscillator running in the absence of  $V_{CC}$  power. Each DS1251 is shipped from Dallas Semiconductor with its lithium energy source disconnected, guaranteeing full energy capacity. When  $V_{CC}$  is first applied at a level greater than  $V_{PF}$ , the lithium energy source is enabled for battery backup operation. Actual life expectancy of the DS1251 will be much longer than 10 years since no lithium battery energy is consumed when  $V_{CC}$  is present.

## CLOCK ACCURACY (DIP MODULE)

The DS1251 is guaranteed to keep time accuracy to within  $\pm 1$  minute per month at 25°C. The clock is calibrated at the factory by Dallas Semiconductor using special calibration nonvolatile tuning elements. The DS1251 does not require additional calibration and temperature deviations will have a negligible effect in most applications. For this reason, methods of field clock calibration are not available and not necessary.

## CLOCK ACCURACY (POWERCAP MODULE)

The DS1251P and DS9034PCX are each individually tested for accuracy. Once mounted together, the module is guaranteed to keep time accuracy to within  $\pm 1.53$  minutes per month (35 ppm) at 25°C.

## ABSOLUTE MAXIMUM RATINGS\*

Voltage on Any Pin Relative to Ground	-0.3V to +7.0V
Operating Temperature	-40°C to +85°C
Storage Temperature	-45°C to +85°C
Soldering Temperature	260°C for 10 seconds (See Note 13)

\* This is a stress rating only and functional operation of the device at these or any other conditions above those indicated in the operation sections of this specification is not implied. Exposure to absolute maximum rating conditions for extended periods of time may affect reliability.

## RECOMMENDED DC OPERATING CONDITIONS (0 C to +85 C)

PARAMETER	SYMBOL	MIN	TYP	MAX	UNITS	NOTES
Logic 1 Voltage All Inputs $V_{CC} = 5V \pm 10\%$	$V_{IH}$	2.2		$V_{CC} + 0.3V$	V	11
$V_{CC} = 3.3V \pm 10\%$	$V_{IH}$	2.0		$V_{CC} + 0.3V$	V	11
Logic 0 Voltage All Inputs $V_{CC} = 5V \pm 10\%$	$V_{IL}$	-0.3		0.8	V	11
$V_{CC} = 3.3V \pm 10\%$	$V_{IL}$	-0.3		0.6	V	11

(-40 C to +85 C;  $V_{CC} = 5V - 10\%$ )(0 C to 70 C;  $V_{CC} = 5V - 10\%$ )**DC ELECTRICAL CHARACTERISTICS**

PARAMETER	SYMBOL	MIN	TYP	MAX	UNITS	NOTES
Input Leakage Current	$I_{IL}$	-1.0		+1.0	$\mu A$	12
I/O Leakage Current $CE \geq V_{IH} [ V_{CC}$	$I_{IO}$	-1.0		+1.0	$\mu A$	
Output Current @ 2.4 volts	$I_{OH}$	-1.0			mA	
Output Current @ 0.4 volts	$I_{OL}$	2.0			mA	
Standby Current $\overline{CE} = 2.2$ volts	$I_{CCS1}$		5	10	mA	
Standby Current $\overline{CE} =$ $V_{CC} - 0.5$ volts	$I_{CCS2}$		3.0	5.0	mA	
Operating Current $t_{CYC} = 70ns$	$I_{CC01}$			85	mA	
Write Protection Voltage	$V_{PF}$	4.25	4.37	4.50	V	11
Battery Switch Over Voltage	$V_{SO}$		$V_{BAT}$		V	11

(-40°C to +85 C;  $V_{CC} = 3.3V \pm 10\%$ )(0 C to 70 C;  $V_{CC} = 3.3V - 10\%$ )**DC ELECTRICAL CHARACTERISTICS**

PARAMETER	SYMBOL	MIN	TYP	MAX	UNITS	NOTES
Input Leakage Current	$I_{IL}$	-1.0		+1.0	$\mu A$	12
I/O Leakage Current $CE \geq V_{IH} [ V_{CC}$	$I_{IO}$	-1.0		+1.0	$\mu A$	
Output Current @ 2.4 volts	$I_{OH}$	-1.0			mA	
Output Current @ 0.4 volts	$I_{OL}$	2.0			mA	
Standby Current $\overline{CE} = 2.2$ volts	$I_{CCS1}$		5	7	mA	
Standby Current $\overline{CE} =$ $V_{CC} - 0.5$ volts	$I_{CCS2}$		2.0	3.0	mA	
Operating Current $t_{CYC} = 70ns$	$I_{CC01}$			50	mA	
Write Protection Voltage	$V_{PF}$	2.80		2.97	V	11
Battery Switch Over Voltage	$V_{SO}$		$V_{BAT}$ OR $V_{PF}$		V	11

**CAPACITANCE** $(t_A = 25^\circ C)$ 

PARAMETER	SYMBOL	MIN	TYP	MAX	UNITS	NOTES
Input Capacitance	$C_{IN}$		5	10	pF	
Input/Output Capacitance	$C_{IO}$		5	10	pF	



**MEMORY AC ELECTRICAL CHARACTERISTICS**(-40°C to +85 C;  $V_{CC} = 5.0V \pm 10\%$ )(0 C to 70 C;  $V_{CC} = 5.0V - 10\%$ )

PARAMETER	SYMBOL	DS1251Y-70		DS1251Y-100		UNITS	NOTES
		MIN	MAX	MIN	MAX		
Read Cycle Time	$t_{RC}$	70		100		ns	
Access Time	$t_{ACC}$		70		100	ns	
$\overline{OE}$ to Output Valid	$t_{OE}$		35		55	ns	
$\overline{CE}$ to Output Valid	$t_{CO}$		70		100	ns	
$\overline{OE}$ or $\overline{CE}$ to Output Active	$t_{COE}$	5		5		ns	5
Output High Z from Deselection	$t_{OD}$		25		35	ns	5
Output Hold from Address Change	$t_{OH}$	5		5		ns	
Write Cycle Time	$t_{WC}$	70		100		ns	
Write Pulse Width	$t_{WP}$	50		70		ns	3
Address Setup Time	$t_{AW}$	0		0		ns	
Write Recovery Time	$t_{WR}$	0		0		ns	
Output High Z from $\overline{WE}$	$t_{ODW}$		25		35	ns	5
Output Active from $\overline{WE}$	$t_{OEW}$	5		5		ns	5
Data Setup Time	$t_{DS}$	30		40		ns	4
Data Hold Time from $\overline{WE}$	$t_{DH}$	5		5		ns	4

**PHANTOM CLOCK AC ELECTRICAL CHARACTERISTICS**(-40°C to +85 °C;  $V_{CC} = 5.0V \pm 10\%$ )(0°C to 70°C;  $V_{CC} = 5.0V - 10\%$ )

PARAMETER	SYMBOL	MIN	TYP	MAX	UNITS	NOTES
Read Cycle Time	$t_{RC}$	65			ns	
$\overline{CE}$ Access Time	$t_{CO}$			55	ns	
$\overline{OE}$ Access Time	$t_{OE}$			55	ns	
$\overline{CE}$ to Output Low Z	$t_{COE}$	5			ns	
$\overline{OE}$ to Output Low Z	$t_{OEE}$	5			ns	
$\overline{CE}$ to Output High Z	$t_{OD}$			25	ns	5
$\overline{OE}$ to Output High Z	$t_{ODO}$			25	ns	5
Read Recovery	$t_{RR}$	10			ns	
Write Cycle Time	$t_{WC}$	65			ns	
Write Pulse Width	$t_{WP}$	55			ns	3
Write Recovery	$t_{WR}$	10			ns	10
Data Setup Time	$t_{DS}$	30			ns	4
Data Hold Time	$t_{DH}$	0			ns	4
$\overline{CE}$ Pulse Width	$t_{CW}$	60			ns	
RESET Pulse Width	$t_{RST}$	65			ns	

**POWER-DOWN/POWER-UP TIMING** $V_{CC} = 5.0V - 10\%$ 

PARAMETER	SYMBOL	MIN	TYP	MAX	UNITS	NOTES
$\overline{CE}$ at $V_{IH}$ before Power-Down	$t_{PD}$	0			$\mu s$	
$V_{CC}$ Slew from $V_{PF(max)}$ to $V_{PF(min)}$ ( $\overline{CE}$ at $V_{PF}$ )	$t_F$	300			$\mu s$	
$V_{CC}$ Slew from $V_{PF(min)}$ to $V_{SO}$	$t_{FB}$	10			$\mu s$	
$V_{CC}$ Slew from $V_{PF(max)}$ to $V_{PF(min)}$ ( $\overline{CE}$ at $V_{PF}$ )	$t_R$	0			$\mu s$	
$\overline{CE}$ at $V_{IH}$ after Power-Up	$t_{REC}$	1.5		2.5	ms	

 $(t_A = 25^\circ C)$ 

PARAMETER	SYMBOL	MIN	TYP	MAX	UNITS	NOTES
Expected Data Retention Time	$t_{DR}$	10			years	9

**WARNING:**

Under no circumstances are negative undershoots, of any amplitude, allowed when device is in battery backup mode.

**MEMORY AC ELECTRICAL CHARACTERISTICS**(-40 °C to +85 °C;  $V_{CC} = 3.3V - 10\%$ )(0 °C to 70 °C;  $V_{CC} = 3.3V - 10\%$ )

PARAMETER	SYMBOL	DS1251W-120		DS1251W-150		UNITS	NOTES
		MIN	MAX	MIN	MAX		
Read Cycle Time	$t_{RC}$	120		150		ns	
Access Time	$t_{ACC}$		120		150	ns	
$\overline{OE}$ to Output Valid	$t_{OE}$		60		75	ns	
$\overline{CE}$ to Output Valid	$t_{CO}$		120		150	ns	
$\overline{OE}$ or $\overline{CE}$ to Output Active	$t_{COE}$	5		5		ns	5
Output High Z from Deselection	$t_{OD}$		40		70	ns	5
Output Hold from Address Change	$t_{OH}$	5		5		ns	
Write Cycle Time	$t_{WC}$	120		150		ns	
Write Pulse Width	$t_{WP}$	90		100		ns	3
Address Setup Time	$t_{AW}$	0		0		ns	
Write Recovery Time	$t_{WR}$	20		20		ns	10
Output High Z from $\overline{WE}$	$t_{ODW}$		40		70	ns	5
Output Active from $\overline{WE}$	$t_{OEW}$	5		5		ns	5
Data Setup Time	$t_{DS}$	50		60		ns	4
Data Hold Time from $\overline{WE}$	$t_{DH}$	20		20		ns	4

**PHANTOM CLOCK AC ELECTRICAL CHARACTERISTICS**(-40 °C to +85 °C;  $V_{CC} = 3.3V - 10\%$ )(0 °C to 70 °C;  $V_{CC} = 3.3V - 10\%$ )

PARAMETER	SYMBOL	MIN	TYP	MAX	UNITS	NOTES
Read Cycle Time	$t_{RC}$	120			ns	
$\overline{CE}$ Access Time	$t_{CO}$			100	ns	
$\overline{OE}$ Access Time	$t_{OE}$			100	ns	
$\overline{CE}$ to Output Low Z	$t_{COE}$	5			ns	
$\overline{OE}$ to Output Low Z	$t_{OEE}$	5			ns	
$\overline{CE}$ to Output High Z	$t_{OD}$			40	ns	5
$\overline{OE}$ to Output High Z	$t_{ODO}$			40	ns	5
Read Recovery	$t_{RR}$	20			ns	
Write Cycle Time	$t_{WC}$	120			ns	
Write Pulse Width	$t_{WP}$	100			ns	3
Write Recovery	$t_{WR}$	20			ns	10
Data Setup Time	$t_{DS}$	45			ns	4
Data Hold Time	$t_{DH}$	0			ns	4
$\overline{CE}$ Pulse Width	$t_{CW}$	105			ns	
RESET Pulse Width	$t_{RST}$	120			ns	

**POWER-DOWN/POWER-UP TIMING****V<sub>CC</sub> = 3.3V – 10%**

PARAMETER	SYMBOL	MIN	TYP	MAX	UNITS	NOTES
$\overline{\text{CE}}$ at V <sub>IH</sub> before Power-Down	t <sub>PD</sub>	0			μs	
V <sub>CC</sub> Slew from V <sub>PF(max)</sub> to V <sub>PF(min)</sub> ( $\overline{\text{CE}}$ at V <sub>IH</sub> )	t <sub>F</sub>	300			μs	
V <sub>CC</sub> Slew from V <sub>PF(max)</sub> to V <sub>PF(min)</sub> ( $\overline{\text{CE}}$ at V <sub>IH</sub> )	t <sub>R</sub>	0			μs	
$\overline{\text{CE}}$ at V <sub>IH</sub> after Power-Up	t <sub>REC</sub>	1.5		2.5	ms	

(t<sub>A</sub> = 25 °C)

PARAMETER	SYMBOL	MIN	TYP	MAX	UNITS	NOTES
Expected Data Retention Time	t <sub>DR</sub>	10			years	9

**WARNING:**

Under no circumstances are negative undershoots, of any amplitude, allowed when device is in battery backup mode.

### MEMORY READ CYCLE (NOTE 1)

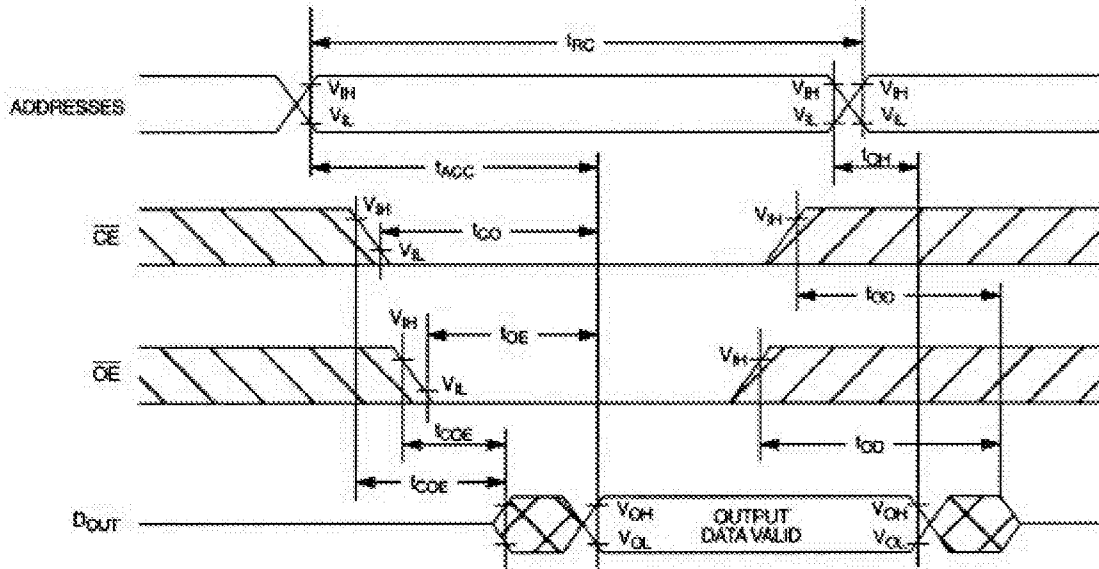

### MEMORY WRITE CYCLE 1 (NOTES 2, 6, AND 7)

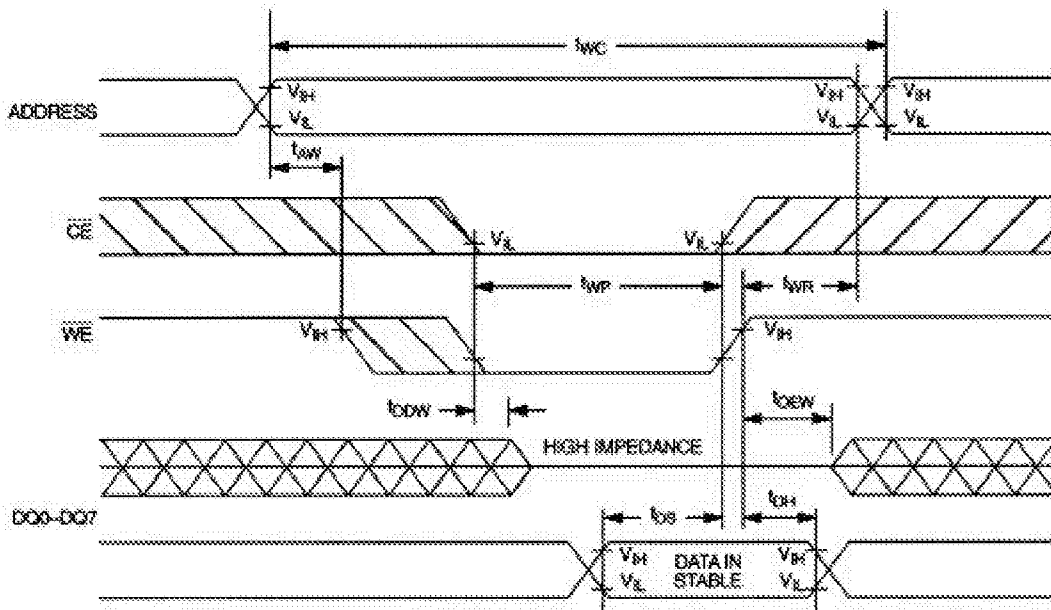

## MEMORY WRITE CYCLE 2 (NOTES 2 AND 8)

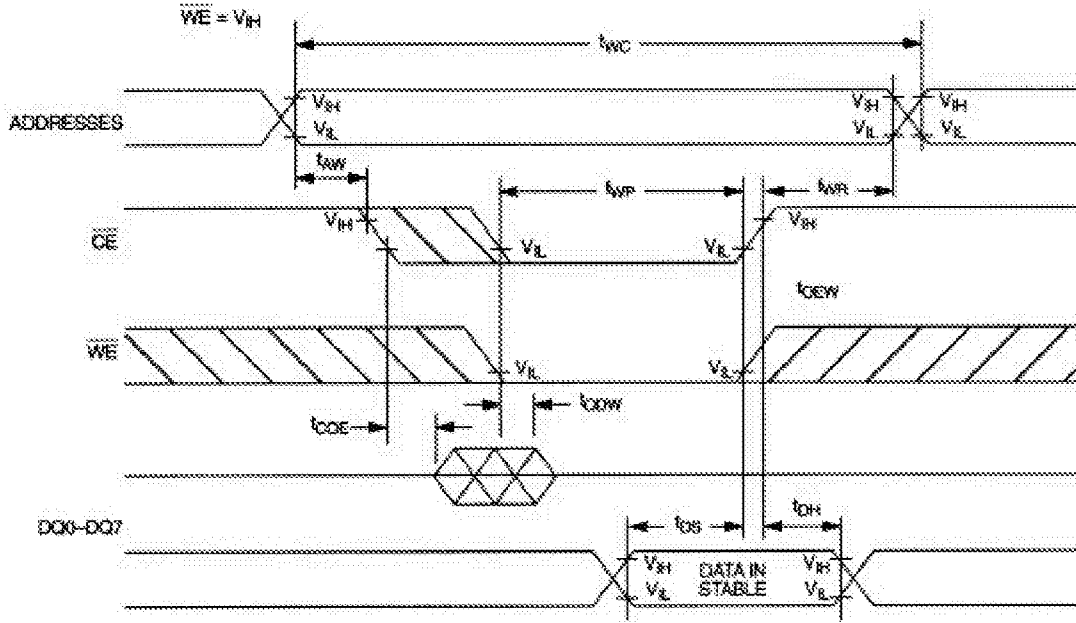

## RESET FOR PHANTOM CLOCK

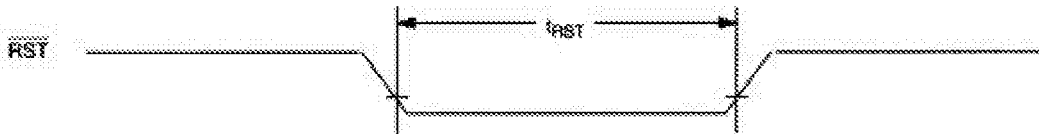

## READ CYCLE TO PHANTOM CLOCK

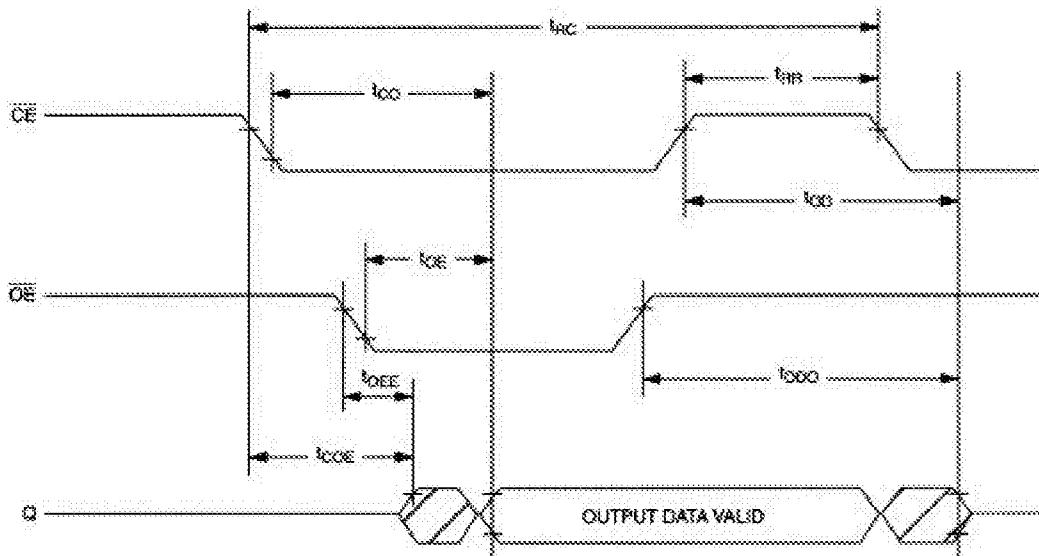

## WRITE CYCLE TO PHANTOM CLOCK

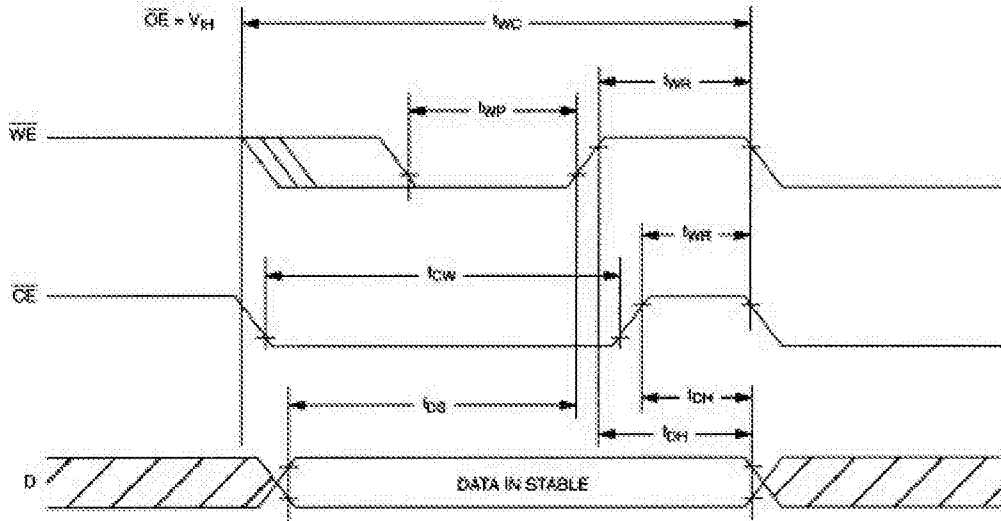

## POWER-DOWN/POWER-UP CONDITION (5 VOLT DEVICE)

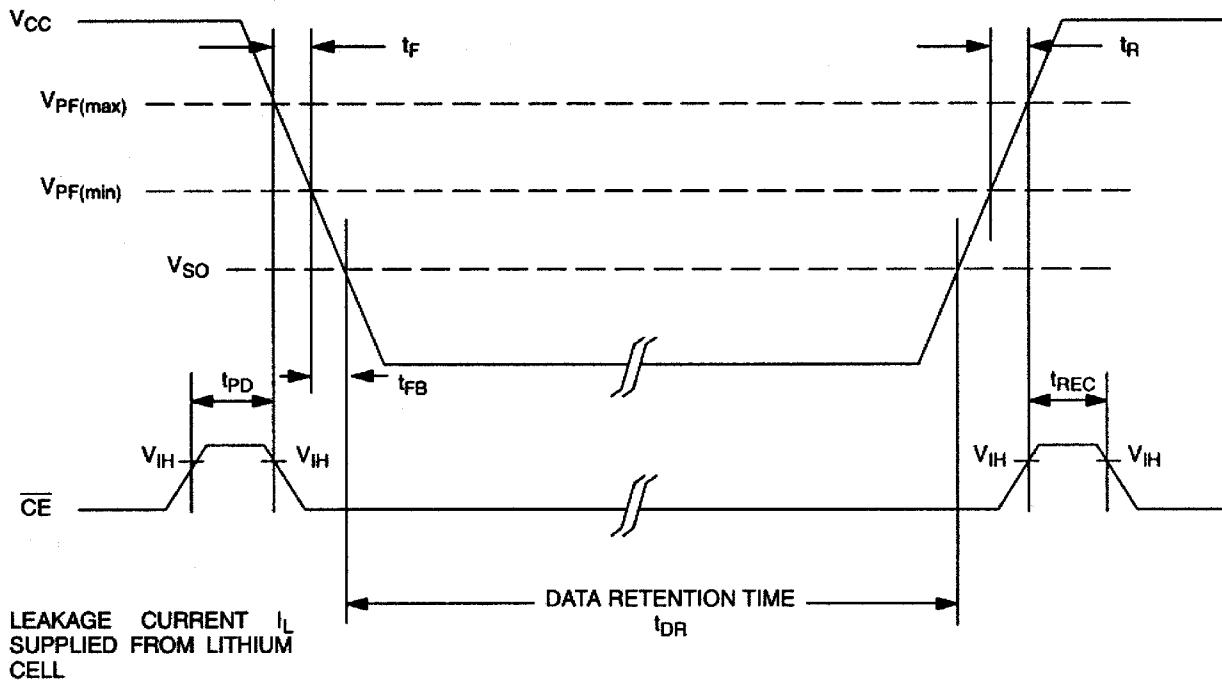

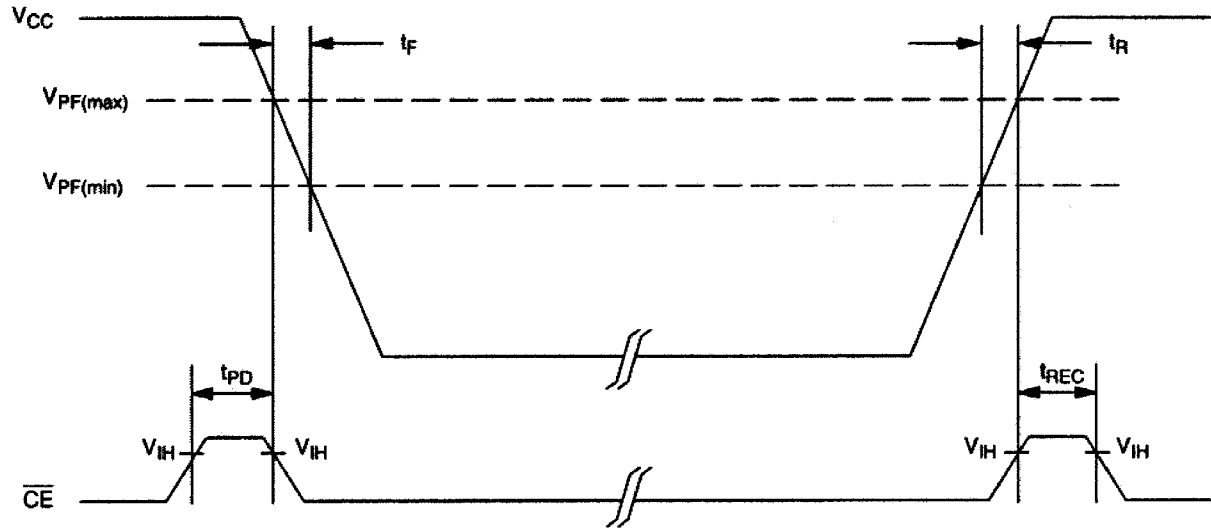
**POWER-DOWN/POWER-UP CONDITION (3.3 VOLT DEVICE)**



## AC TEST CONDITIONS

Output Load:	50 pF + 1TTL Gate	Timing Measurement Reference Levels	
Input Pulse Levels:	0–3 volts	Input:	1.5 volts
		Output:	1.5 volts
		Input Pulse Rise and Fall Times:	5 ns

### NOTES:

1.  $\overline{WE}$  is high for a read cycle.
2.  $OE = V_{IH}$  or  $V_{IL}$ . If  $OE = V_{IH}$  during write cycle, the output buffers remain in a high impedance state.
3.  $t_{WP}$  is specified as the logical AND of  $\overline{CE}$  and  $\overline{WE}$ .  $t_{WP}$  is measured from the latter of  $\overline{CE}$  or  $\overline{WE}$  going low to the earlier of  $\overline{CE}$  or  $\overline{WE}$  going high.
4.  $t_{DH}$ ,  $t_{DS}$  are measured from the earlier of  $\overline{CE}$  or  $\overline{WE}$  going high.
5. These parameters are sampled with a 50 pF load and are not 100% tested.
6. If the  $\overline{CE}$  low transition occurs simultaneously with or later than the  $\overline{WE}$  low transition in Write Cycle 1, the output buffers remain in a high impedance state during this period.
7. If the  $\overline{CE}$  high transition occurs prior to or simultaneously with the  $\overline{WE}$  high transition, the output buffers remain in a high impedance state during this period.
8. If  $\overline{WE}$  is low or the  $\overline{WE}$  low transition occurs prior to or simultaneously with the  $\overline{CE}$  low transition, the output buffers remain in a high impedance state during this period.
9. The expected  $t_{DR}$  is defined as cumulative time in the absence of  $V_{CC}$  with the clock oscillator running.
10.  $t_{WR}$  is a function of the latter occurring edge of  $\overline{WE}$  or  $\overline{CE}$ .
11. Voltage are referenced to ground.
12. RST (Pin1) has an internal pull-up resistor.
13. Real-Time Clock Modules can be successfully processed through conventional wave-soldering techniques as long as temperature exposure to the lithium energy source contained within does not exceed +85°C. Post solder cleaning with water washing techniques is acceptable, provided that ultrasonic vibration is not used.

In addition, for the PowerCap:

- a. Dallas Semiconductor recommends that PowerCap Module bases experience one pass through solder reflow oriented with the label side up (“live – bug”).
- b. Hand Soldering and touch-up: Do not touch or apply the soldering iron to leads for more than 3 (three) seconds.

To solder, apply flux to the pad, heat the lead frame pad and apply solder. To remove the part, apply flux, heat the lead frame pad until the solder reflow and use a solder wick to remove solder.

## DS1251 4096K NV SRAM WITH PHANTOM CLOCK

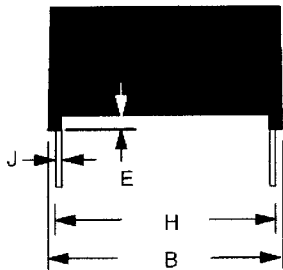
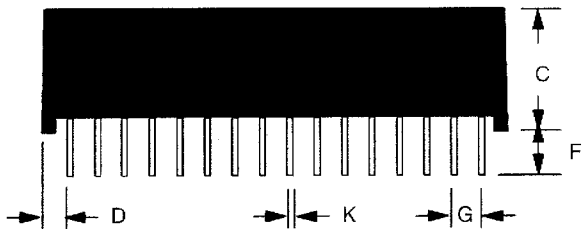
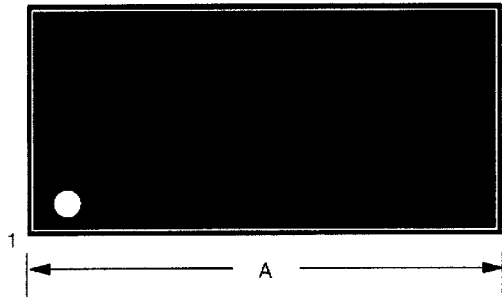

KG	32-PIN	
DIM	MIN	MAX
A IN.	1.720	1.740
MM	43.691	44.20
B IN.	0.720	0.740
MM	18.29	18.80
C IN.	0.395	0.415
MM	10.03	10.54
D IN.	0.090	0.120
MM	2.29	3.05
E IN.	0.017	0.030
MM	0.43	0.76
F IN.	0.120	0.160
MM	3.05	4.06
G IN.	0.090	0.110
MM	2.29	2.79
H IN.	0.590	0.630
MM	14.99	16.00
J IN.	0.008	0.012
MM	0.20	0.30
K IN.	0.015	0.021
MM	0.38	0.53

## DS1251P

PKG DIM	INCHES		
	MIN	NOM	MAX
A	0.920	0.925	0.930
B	0.980	0.985	0.990
C	-	-	0.080
D	0.052	0.055	0.058
E	0.048	0.050	0.052
F	0.015	0.020	0.025
G	0.025	0.027	0.030

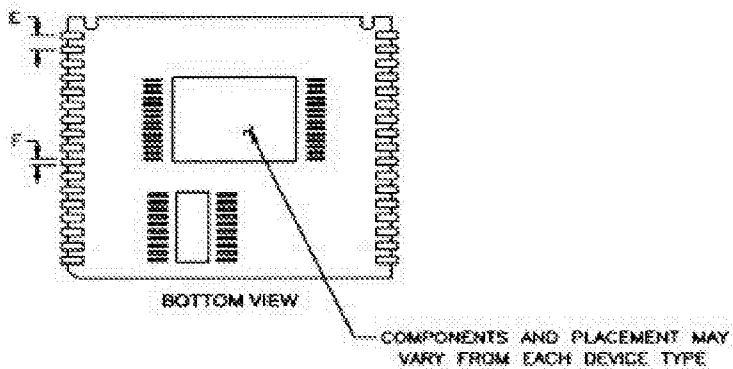
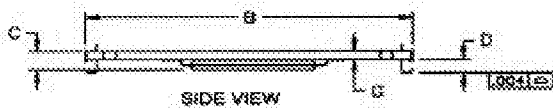
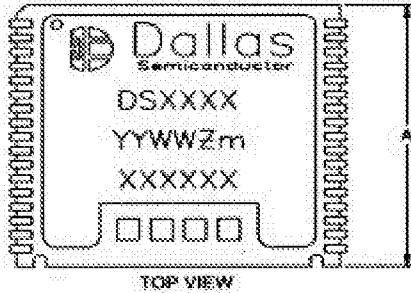
**NOTE:**

Dallas Semiconductor recommends that PowerCap Module bases experience one pass through solder reflow oriented with the label side up (“live – bug”).

Hand Soldering and touch-up: Do not touch or apply the soldering iron to leads for more than 3 (three) seconds. To solder, apply flux to the pad, heat the lead frame pad and apply solder. To remove the part, apply flux, heat the lead frame pad until the solder reflows and use a solder wick to remove solder.

**DS1251P WITH DS9034PCX ATTACHED**

PKG DIM	INCHES		
	MIN	NOM	MAX
A	0.920	0.925	0.930
B	0.955	0.960	0.965
C	0.240	0.245	0.250
D	0.052	0.055	0.058
E	0.048	0.050	0.052
F	0.015	0.020	0.025
G	0.020	0.025	0.030

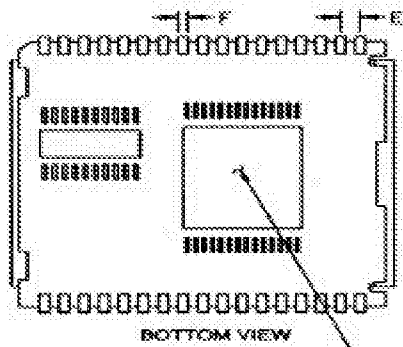
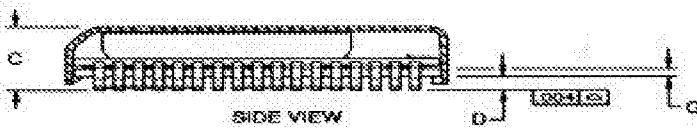
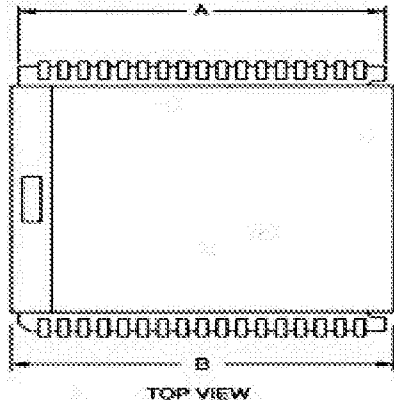

COMPONENTS AND PLACEMENT MAY VARY FROM EACH DEVICE TYPE

## RECOMMENDED POWERCAP MODULE LAND PATTERN

PKG DIM	INCHES		
	MIN	NOM	MAX
A	-	1.050	-
B	-	0.826	-
C	-	0.050	-
D	-	0.030	-
E	-	0.112	-

