

Features

- High Gain: 24 dB @ 30 GHz
- P1dB: 34.5 dBm
- P_{SAT}: 36.5 dBm
- IM3 Level: -27 dBc @ P_{OUT} = 29 dBm/tone
- Power Added Efficiency: 23% @ P_{SAT}
- Return Loss: 10 dB
- Bare Die Dimensions: 3.1 x 2.8 x 0.05 mm
- RoHS* Compliant

Description

The MAAP-011139-DIE is a 4-stage, 4 W power amplifier in bare die form. This power amplifier operates from 28.5 to 31.0 GHz and provides 24 dB of linear gain, 4 W saturated output power, and 23% efficiency while biased at 6 V.

The MAAP-011139-DIE is a power amplifier ideally suited for VSAT communications.

This product is fabricated using a GaAs pHEMT device process which features full passivation for enhanced reliability.

Ordering Information

Part Number	Package
MAAP-011139-DIE	Die in Gel Pack ¹

1. Die quantity varies

Functional Diagram

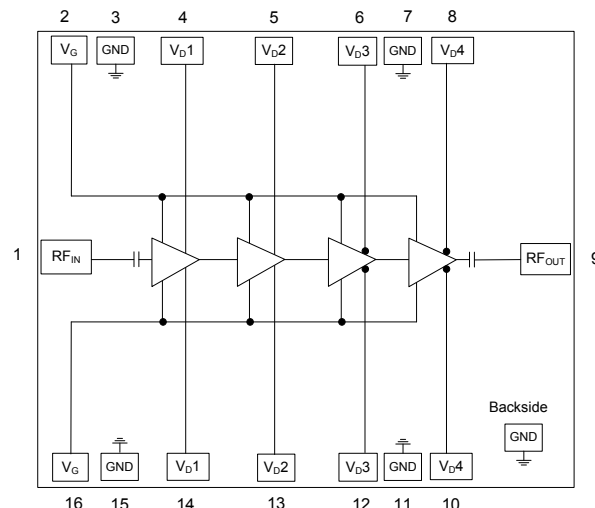

Pin Configuration²

Pad	Function	Description
1	RF _{IN}	RF Input
2, 16	V _G	Gate Voltage
3, 7, 11, 15 & backside	GND	Ground
4, 14	V _{D1}	Drain Voltage 1
5, 13	V _{D2}	Drain Voltage 2
6, 12	V _{D3}	Drain Voltage 3
8, 10	V _{D4}	Drain Voltage 4
9	RF _{OUT}	RF Output

2. Backside metal is RF, DC and thermal ground.

* Restrictions on Hazardous Substances, European Union Directive 2011/65/EU.

Electrical Specifications³: Freq. = 30 GHz, T_C = +25°C, V_D = +6 V, Z₀ = 50 Ω

Parameter	Test Conditions	Units	Min.	Typ.	Max.
Gain	P _{IN} = 0 dBm	dB	22	24	—
P _{OUT}	P _{IN} = 17 dBm	dBm	35.0	36.5	—
IM3 Level	P _{OUT} = 29 dBm / tone	dBc	—	-27	—
Power Added Efficiency	P _{SAT} (P _{IN} = 17 dBm)	%	—	23	—
Input Return Loss	P _{IN} = -20 dBm	dB	—	10	—
Output Return Loss	P _{IN} = -20 dBm	dB	—	10	—
Quiescent Current	I _{DQ} (see bias conditions, page 5)	mA	—	2000	—
Current	P _{SAT} (P _{IN} = +17 dBm)	mA	—	3200	—

3. Specifications apply to MMIC die with two RF input and two RF output bond wires.

Maximum Operating Ratings

Parameter	Rating
Input Power	+17 dBm
Junction Temperature ^{4,5}	+160°C
Operating Temperature	-40°C to +85°C

4. Operating at nominal conditions with junction temperature ≤ +160°C will ensure MTTF > 1 x 10⁶ hours.
5. Junction Temperature (T_J) = T_C + Θ_{JC} * ((V * I) - (P_{out} - P_{IN}))
Typical thermal resistance (Θ_{JC}) = 3.4°C/W.
- a) For T_C = +25°C,
T_J = +75°C @ 6 V, 3.2 A, P_{OUT} = 36.5 dBm, P_{IN} = 17 dBm
- b) For T_C = +85°C,
T_J = +133°C @ 6 V, 3.0 A, P_{OUT} = 36.0 dBm, P_{IN} = 17 dBm

Absolute Maximum Ratings^{6,7}

Parameter	Absolute Maximum
Input Power	+23 dBm
Drain Voltage	+6.5 V
Gate Voltage	-3 to 0 V
Junction Temperature ⁸	+175°C
Storage Temperature	-65°C to +150°C

6. Exceeding any one or combination of these limits may cause permanent damage to this device.
7. MACOM does not recommend sustained operation near these survivability limits.
8. Junction temperature directly effects device MTTF. Junction temperature should be kept as low as possible to maximize lifetime.

Application PCB Layout

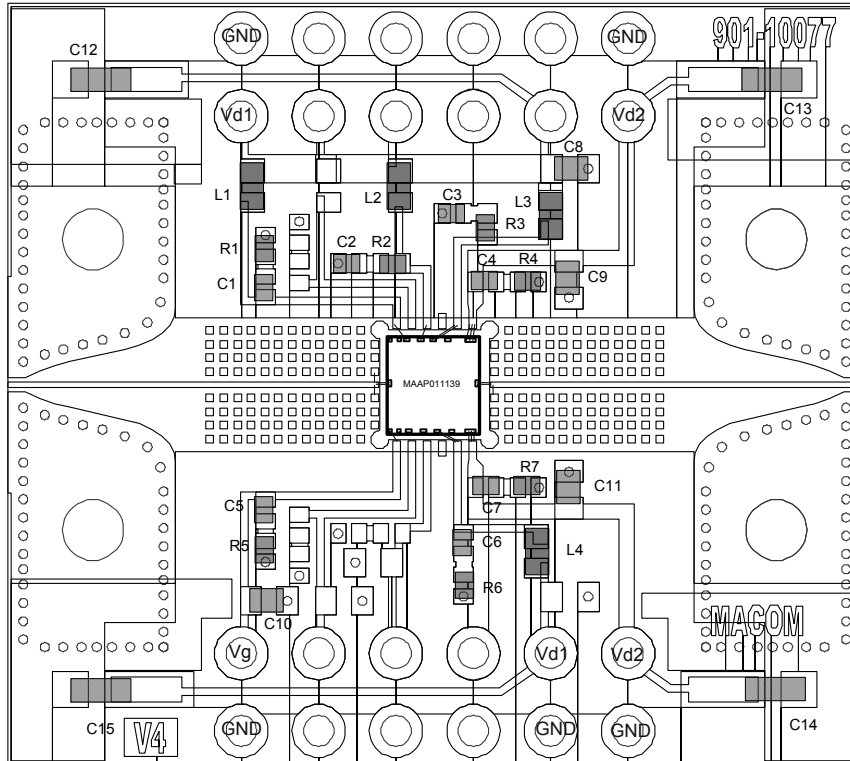

Application Diagram

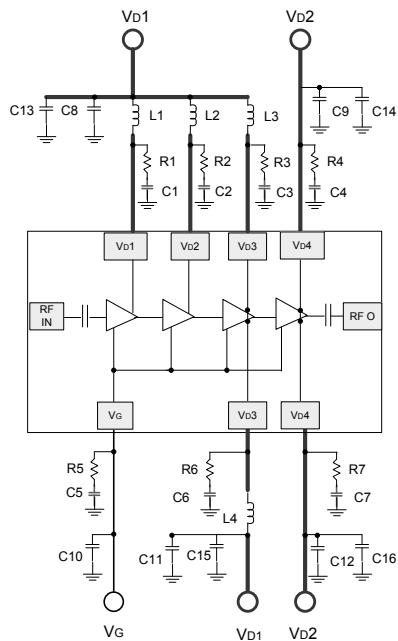

Application Parts List

Part	Value	Case Style
C1 - C7	0.01 μ F	0402
C8 - C12	1 μ F	0603
C13 - C16	10 μ F	0805
R1 - R7	10 Ω	0402
L1 - L4 (Chip Ferrite Bead)	BLM18HE601SN1D	0603

PCB Material Specifications

Top Layer: 1/2 oz Copper Cladding, 0.017 mm thickness
Dielectric Layer: Rogers RO4350B, 0.101 mm thickness
Bottom Layer: 1/2 oz Copper Cladding, 0.017 mm thickness
Finished overall thickness: 0.135 mm

Recommended Bonding Diagram and PCB Layout Detail:

For optimum power match, RF input and output microstrip lines require open stubs on the application board for bonding wire inductance compensation. Optimum bonding wire inductance for the RF I/O connection is 0.2 nH, and physical length for the gold bond wire (.001" dia.) is approximately 350 μm each for the two wire connection.

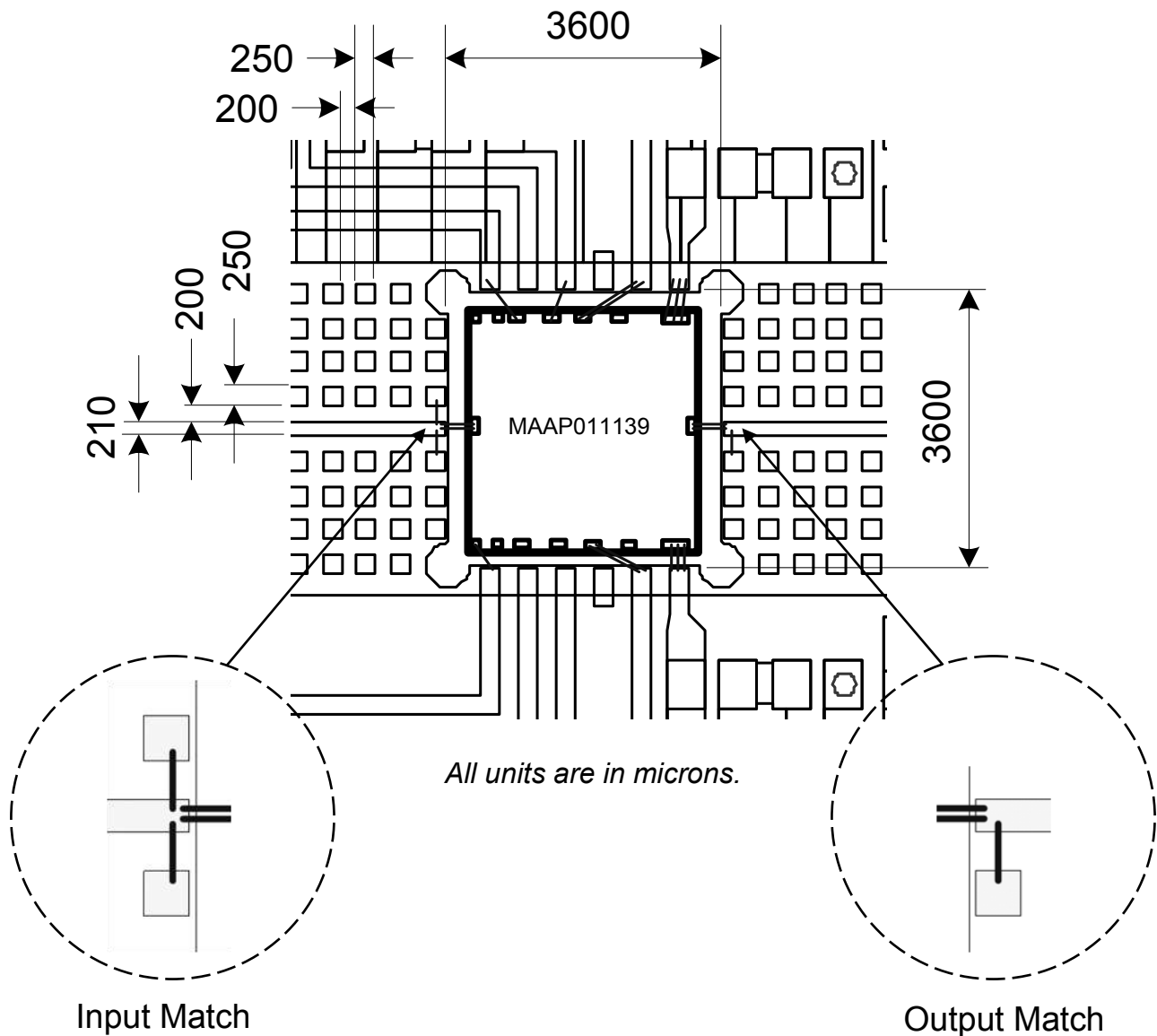

Application Information

The MAAP-011139 is designed to be easy to use yet high performance. The ultra small size and simple bias allow easy placement on system board. RF input and output ports are DC de-coupled internally.

Biasing conditions

Recommended biasing conditions are $V_D = 6\text{ V}$, $I_{DQ} = 2000\text{ mA}$ (controlled with V_G). The drain bias voltage range is 3 to 6 V, and the quiescent drain current biasing range is 1500 to 2500 mA.

V_G pads 2 and 16 are connected internally; choose either pad for layout convenience. Muting can be accomplished by setting the V_G to the pinched off voltage ($V_G = -2\text{ V}$).

V_D bias must be applied to V_{D1} , V_{D2} , V_{D3} , and V_{D4} pads.

V_{D1} pads 4 and 14 are connected internally, and only one pad is required for biasing. Choose either pad for layout convenience.

V_{D2} pads 5 and 13 are connected internally, and only one pad is required for biasing. Choose either pad for layout convenience.

Both V_{D3} pads (6 and 12) are required for current symmetry.

Both V_{D4} pads (8 and 10) are required for current symmetry.

Die Attachment

This product is manufactured from 0.050 mm (0.002") thick GaAs substrate and has vias through to the backside to enable grounding to the circuit.

Recommended conductive epoxy is Namics Unimec XH9890-6. Epoxy should be applied and cured in accordance with the manufacturer's specifications and should avoid contact with the top of the die.

Operating the MAAP-011139-DIE

Turn-on

1. Apply V_G (-1.5 V).
2. Apply V_D (6.0 V typical).
3. Set I_{DQ} by adjusting V_G more positive (typically $V_G \sim -0.9\text{ V}$ for $I_{DQ} = 2000\text{ mA}$).
4. Apply RF_{IN} signal.

Turn-off

1. Remove RF_{IN} signal.
2. Decrease V_G to -1.5 V.
3. Decrease V_D to 0 V.

Handling Procedures

Please observe the following precautions to avoid damage:

Static Sensitivity

These electronic devices are sensitive to electrostatic discharge (ESD) and can be damaged by static electricity. Proper ESD control techniques should be used when handling these HBM Class 1A devices.

Typical Performance Curves⁹

Small Signal Gain vs. Frequency over Temperature

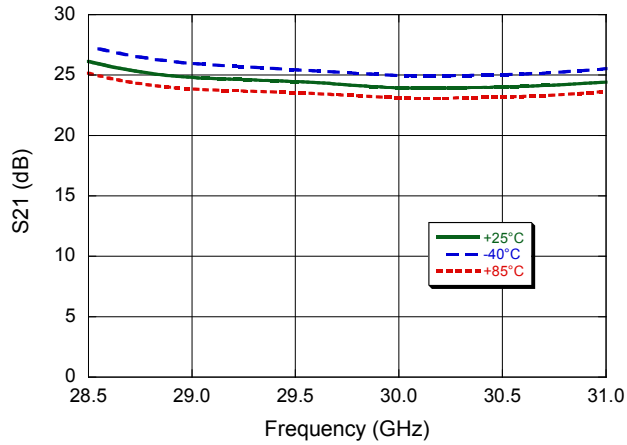

Small Signal Gain vs. Frequency over Bias Voltage

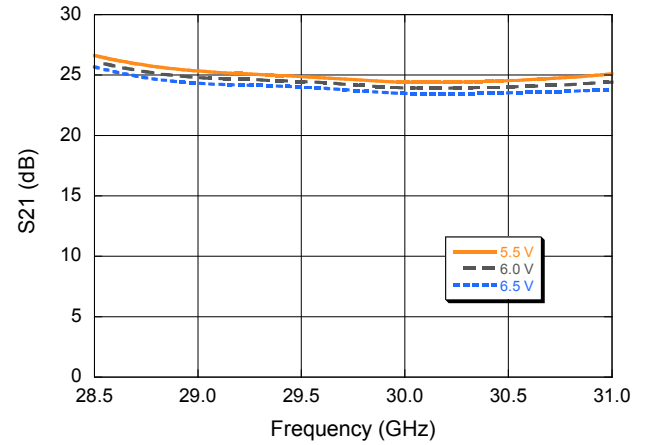

Input Return Loss vs. Frequency over Temperature

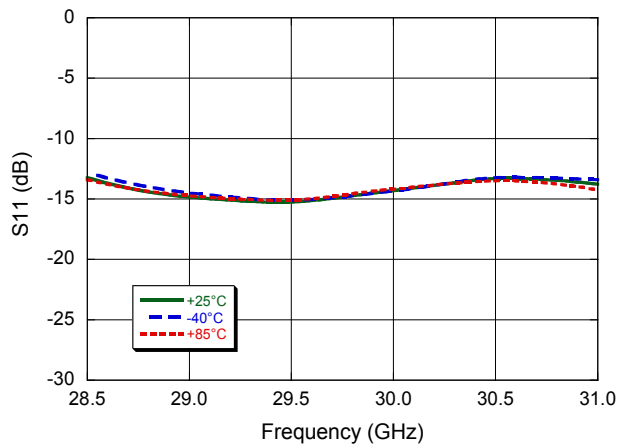

Input Return Loss vs. Frequency over Bias Voltage

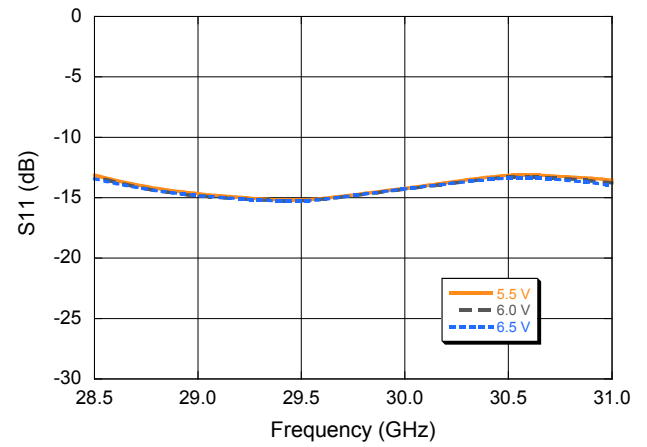

Output Return Loss vs. Frequency over Temperature

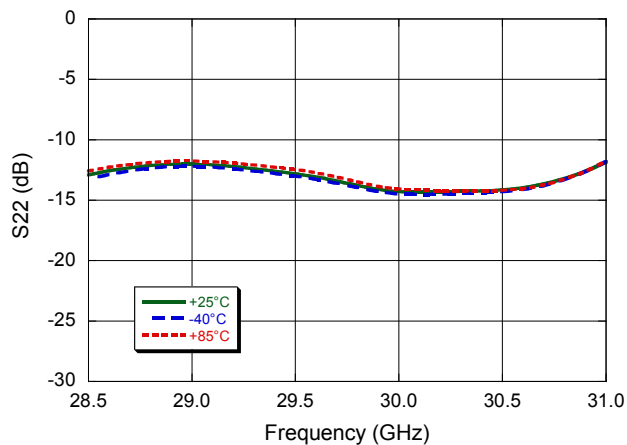

Output Return Loss vs. Frequency over Bias Voltage

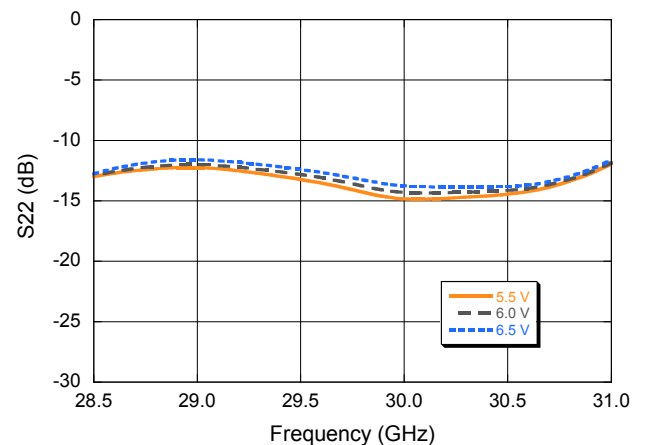

Typical Performance Curves⁹

P_{SAT} vs. Frequency over Temperature

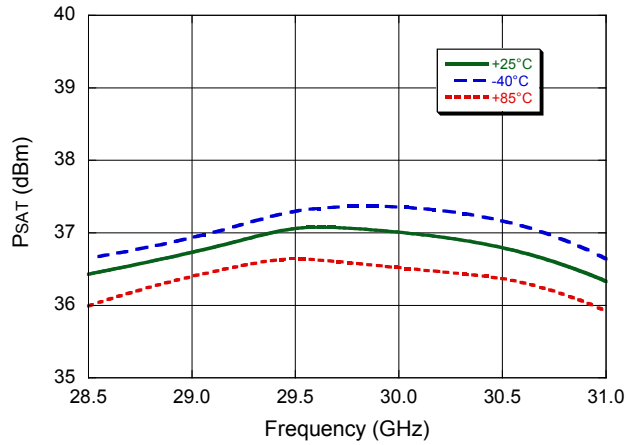

P_{SAT} vs. Frequency over Bias Voltage

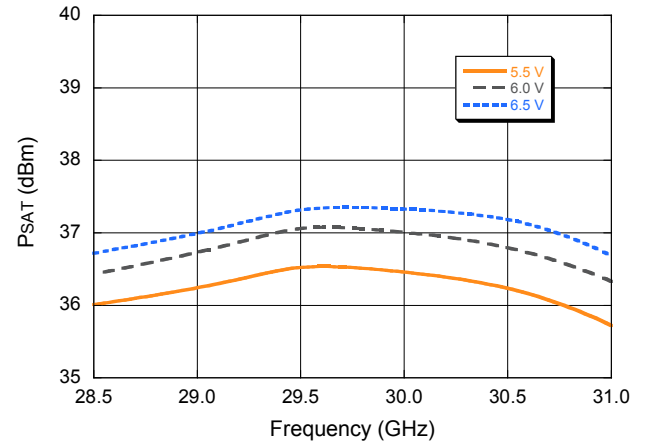

P_{1dB} vs. Frequency over Temperature

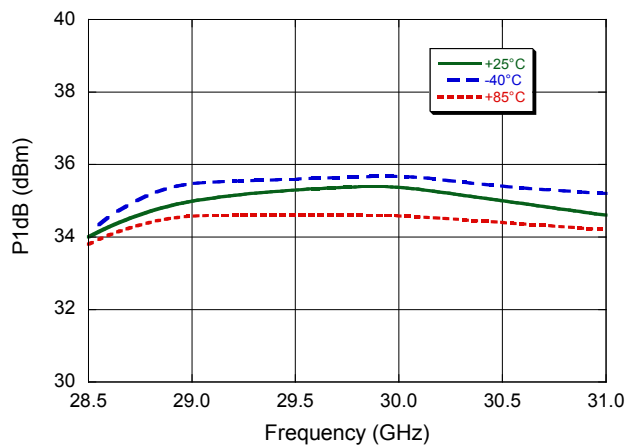

P_{1dB} vs. Frequency over Bias Voltage

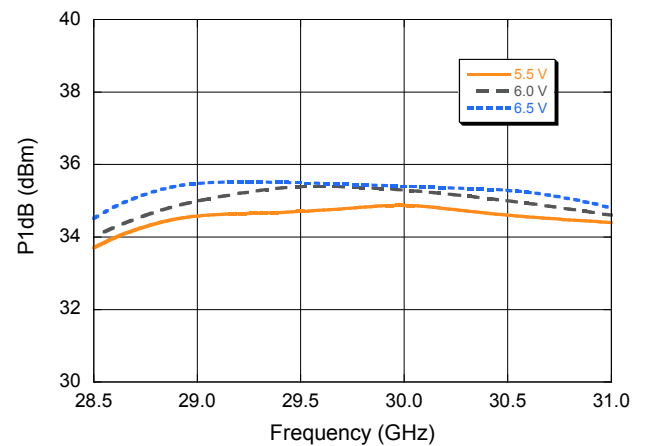

Typical Performance Curves⁹

Output IP3 vs. Frequency over Temperature

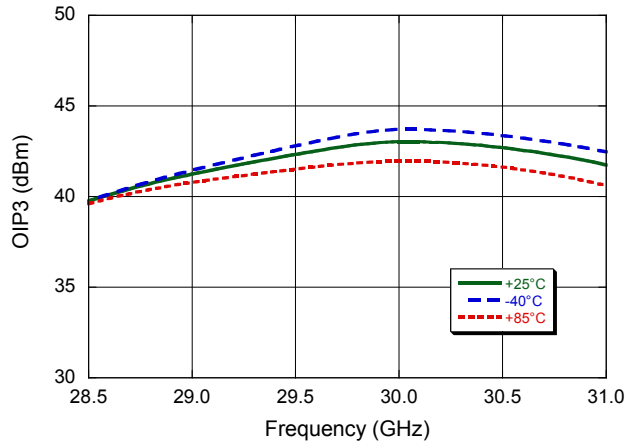

Output IP3 vs. Frequency over Bias Voltage

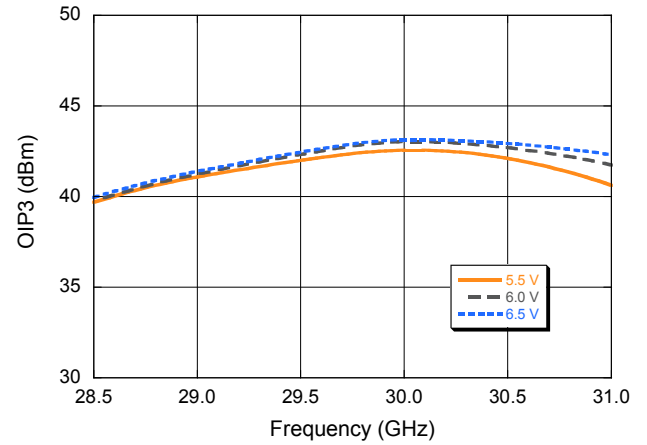

IM3 vs. Frequency over Temperature
($P_{OUT} = +29$ dBm/Tone)

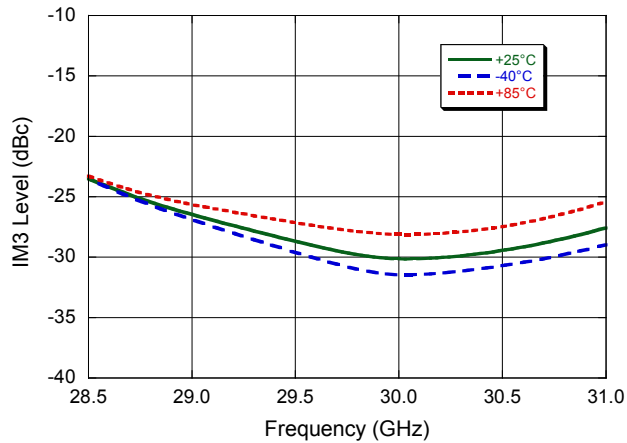

IM3 vs. Frequency over Bias Voltage
($P_{OUT} = +29$ dBm/Tone)

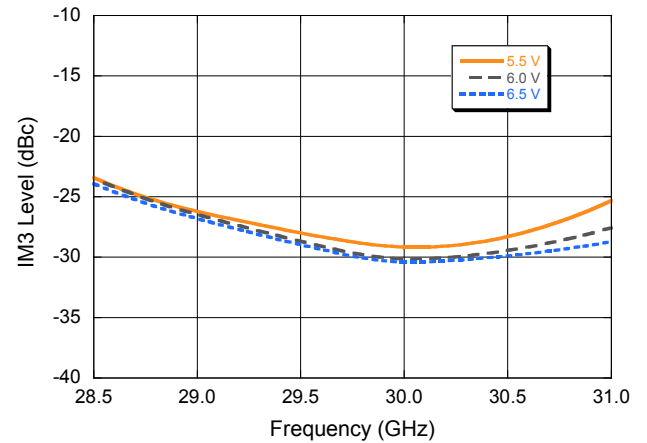

Typical Performance Curves⁹

P_{1dB}, P_{SAT} vs. Frequency

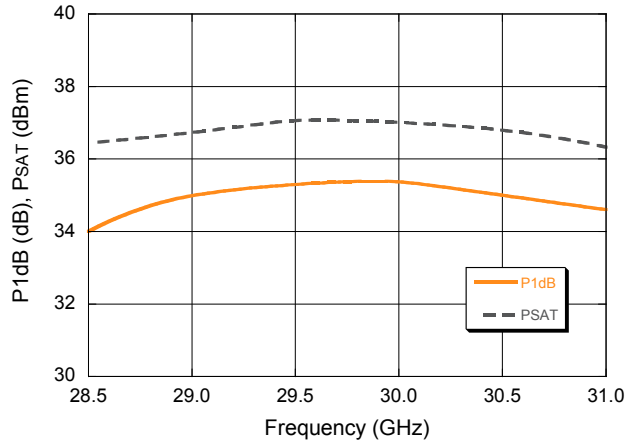

PAE vs. Frequency

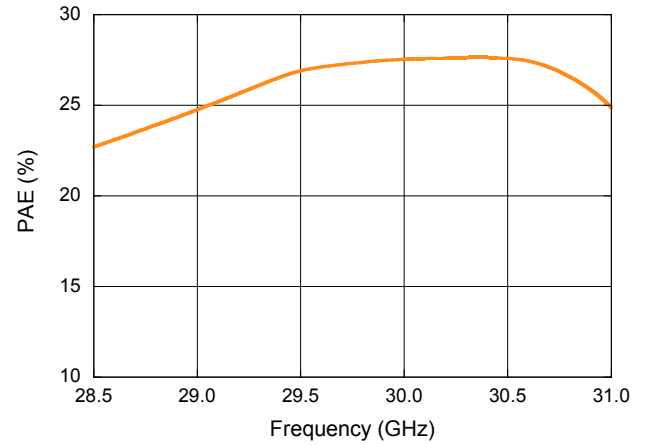

IM3 vs. Output Power per Tone

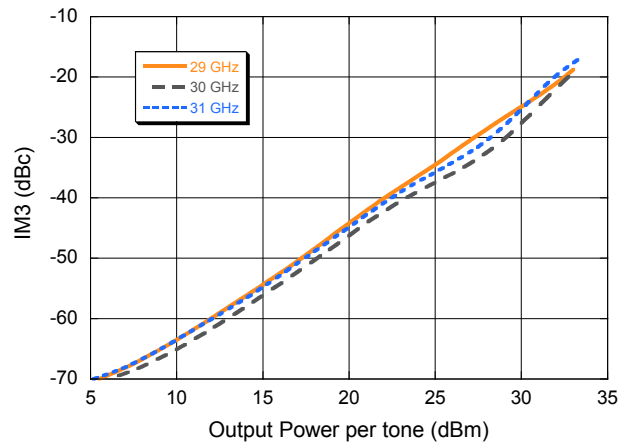

Output IP3 vs. Output Power per Tone

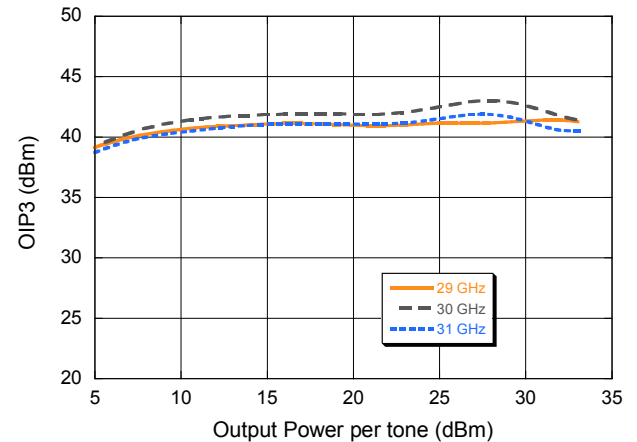

Typical Performance Curves⁹

Output Power vs. Input Power

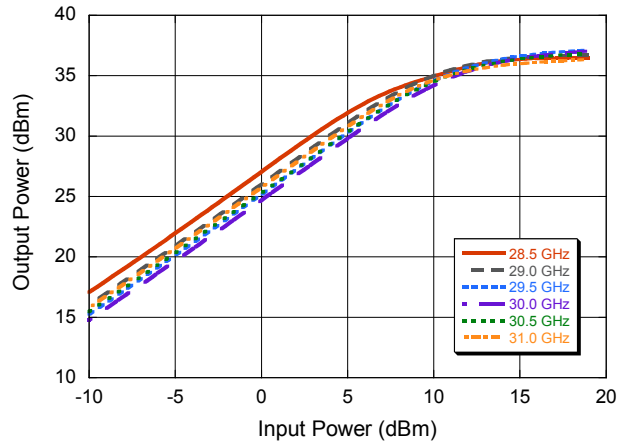

PAE vs. Input Power

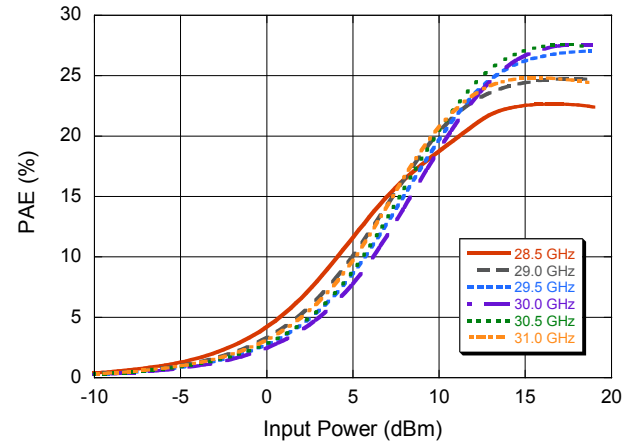

Drain Current vs. Input Power

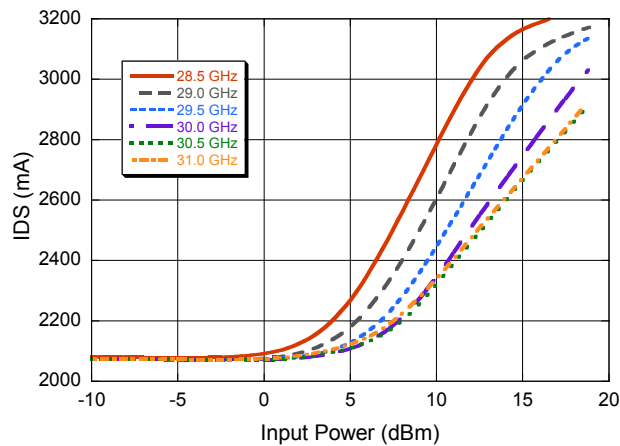

Quiescent Drain Current over Temperature

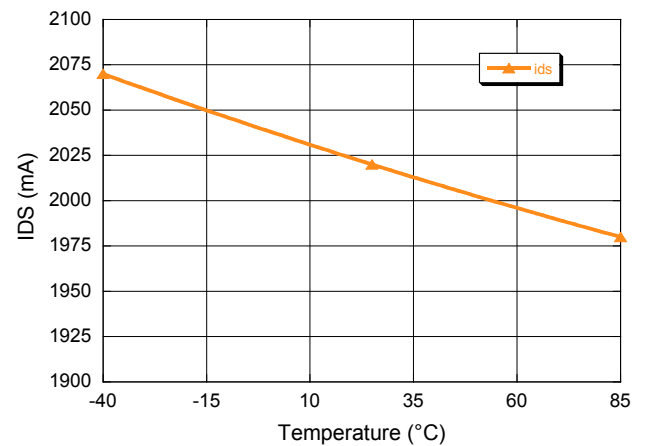

9. Typical performance curves are achieved by using the recommended bonding diagram and PCB layout detail.

MMIC Die Outline

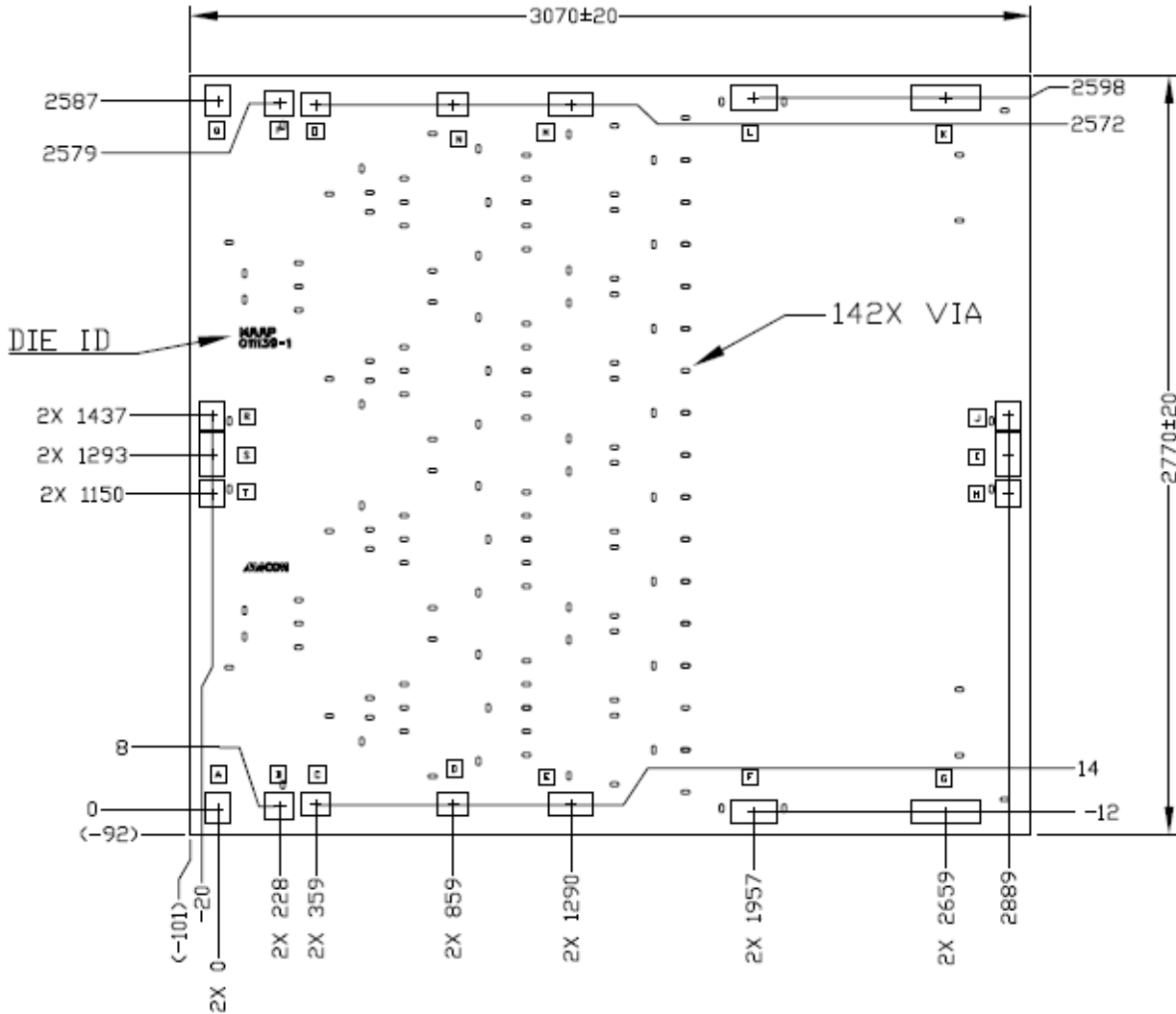

Bond Pad Detail

Pad	Size (x)	Size (y)
A, Q	88	112
B, P	105	96
C, D, O, N	108	83
E, M	163	83
F, L	169	88
G, K	248	88
H, J, R, T	89	99
I, S	89	159

Notes:

1. All units are in μm , unless otherwise noted, with a tolerance of $\pm 5 \mu\text{m}$.
2. Die thickness is $50 \pm 10 \mu\text{m}$.

M/A-COM Technology Solutions Inc. All rights reserved.

Information in this document is provided in connection with M/A-COM Technology Solutions Inc ("MACOM") products. These materials are provided by MACOM as a service to its customers and may be used for informational purposes only. Except as provided in MACOM's Terms and Conditions of Sale for such products or in any separate agreement related to this document, MACOM assumes no liability whatsoever. MACOM assumes no responsibility for errors or omissions in these materials. MACOM may make changes to specifications and product descriptions at any time, without notice. MACOM makes no commitment to update the information and shall have no responsibility whatsoever for conflicts or incompatibilities arising from future changes to its specifications and product descriptions. No license, express or implied, by estoppel or otherwise, to any intellectual property rights is granted by this document.

THESE MATERIALS ARE PROVIDED "AS IS" WITHOUT WARRANTY OF ANY KIND, EITHER EXPRESS OR IMPLIED, RELATING TO SALE AND/OR USE OF MACOM PRODUCTS INCLUDING LIABILITY OR WARRANTIES RELATING TO FITNESS FOR A PARTICULAR PURPOSE, CONSEQUENTIAL OR INCIDENTAL DAMAGES, MERCHANTABILITY, OR INFRINGEMENT OF ANY PATENT, COPYRIGHT OR OTHER INTELLECTUAL PROPERTY RIGHT. MACOM FURTHER DOES NOT WARRANT THE ACCURACY OR COMPLETENESS OF THE INFORMATION, TEXT, GRAPHICS OR OTHER ITEMS CONTAINED WITHIN THESE MATERIALS. MACOM SHALL NOT BE LIABLE FOR ANY SPECIAL, INDIRECT, INCIDENTAL, OR CONSEQUENTIAL DAMAGES, INCLUDING WITHOUT LIMITATION, LOST REVENUES OR LOST PROFITS, WHICH MAY RESULT FROM THE USE OF THESE MATERIALS.

MACOM products are not intended for use in medical, lifesaving or life sustaining applications. MACOM customers using or selling MACOM products for use in such applications do so at their own risk and agree to fully indemnify MACOM for any damages resulting from such improper use or sale.